

Chirurgische Instrumente

Surgical Instruments

Instrumental quirúrgico

Strumenti chirurgici



Willkommen Welcome



Sehr geehrter Kunde,

ich freue mich Ihnen unseren neuen komplett überarbeiteten Hauptkatalog über chirurgische Instrumente vorstellen zu dürfen. Bei der Auswahl der Produkte, sind wir mit größtmöglicher Sorgfalt bezüglich der Aktualität der Instrumente vorgegangen. Nun besteht die Möglichkeit sich die Instrumente selbst zusammen zu stellen, oder aber, Sie können sich von uns Instrumentensätze zusammenstellen lassen, die uns für Ihre jeweils spezifischen Aufgaben als geeignet scheinen. Für Fragen stehe ich und mein Team Ihnen gerne jederzeit zur Verfügung und freuen uns über jede Anfrage.

Dear customer,

I am very pleased to present you our, new completely revised main catalogue of surgical instruments. When selecting the products, we took extreme care to ensure that the instruments are up to date. It is possible to assemble the instruments sets yourself at your request, or to have us assemble sets of instruments that we judge to be suitable for your specific tasks. Please do not hesitate to contact myself or my Team for any help.

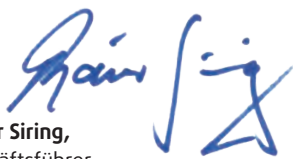

Rainer Siring,
Geschäftsführer

Estimado cliente,

me alegra poder presentarles nuestro nuevo catálogo general de instrumentos quirúrgicos para las diferentes especialidades, completamente revisado. Para la selección de los productos en las diferentes especialidades hemos procedido con el máximo esmero posible en relación a la actualidad de los instrumentos. En todas las especialidades quirúrgicas existe la posibilidad de agrupar por si mismo los instrumentos, o bien Ud. también puede solicitar que nosotros agrupemos juegos de instrumentos apropiados para sus tareas específicas. Si tiene alguna pregunta, yo y mi equipo estaremos encantados de ayudarle en cualquier momento y esperamos sus consultas.

Gentile cliente,

sono lieto di poterle presentare il nostro nuovo catalogo generale di Strumenti chirurgici delle più diverse discipline, completamente rielaborato. Per la scelta dei prodotti nelle diverse discipline abbiamo proceduto con massima accuratezza in riguardo all'attualità degli strumenti. È possibile assortire in modo individuale gli strumenti tutte le discipline chirurgiche correnti, oppure, sù richiesta, Le possiamo anche proporre un assortimento di set di strumenti, che ci sembrano appropriati di volta in volta ai Suoi compiti specifici.

Inhaltsverzeichnis

Table of content

Tabla de catálogo

Indice di catalogo

010	Skalpelle und Messer Scalpels and Knives Bisturios y Cuchillos Bisturi e Coltelli	01-14
011	Mikro-Scheren Micro Scissors Micro Tijaras Micro Forbici	15-20
012	Scheren Scissors Tijaras Forbici	21-76
013	Pinzetten - anatomische, chirurgische, Mikro Forceps - anatomics, surgicals, Micro Pinzas - anatómicas, quirúrgicas, Micro Pinze - anatomiche, chirurgici, Micro	77-100
015	Arterienklemmen, Korn- und Tupferzangen Artery Forceps, Dressing and Sponge Forceps Pinzas hemostáticas, Pinzas para torundo y vendajes Pinze emostatiche, Pinze per medicatura e tamponi	101-152
016	Wundhaken, Wundspreizer, Bauchdeckenhalter Retractors, Self-retaining Retractors, Abdominal Retractors Separadores, Separadores autoestáticos, Separadores abdominales Divaricatori, Divaricatori autostatici, Divaricatori addominali	153-222
017	Sonden, Aspiration Probes, Aspiration Sondas, Aspiración Sonde, Aspirazione	223-246
018	Diagnostik, Narkose Diagnostics, Anaesthesia Diagnóstico, Anestesia Diagnóstica, Anestesia	247-286
019	Naht Suture Sutura Sutura	287-340
020	Verband, Gips Dressing, Plaster Vendajes, Escayolas Bendaggi, Gessatura	341-350

021	Knochenchirurgie Bone Surgery Cirugía ósea Chirurgia ossea	351-378
024	Knochenchirurgie Bone Surgery Cirugía ósea Chirurgia ossea	388-470
025	Thorax, Cardiovascular-Chirurgie Thorax, Cardiovascular Surgery Torácio, Cirugía cardiovascular Torace, Chirurgia cardiovascolare	471-542
026	Neurochirurgie, Laminektomie Neurosurgery, Laminectomy Neurocirugía, Laminectomía Neurochirurgia, Laminectomia	543-602
027	Magen, Darm, Urologie Stomach, Intestines, Urology Estómago, Intestinos, Urología Stomaco, Intestini, Urologia	603-646
030	Gynäkologie, Geburtshilfe Gynecology, Obstetrics Ginecología, Ostetricia Ginecologia, Ostetricia	647-702
032	Ophthalmologie Ophthalmology Oftalmología Ophtalmologia	703-726
034	Otologie Otology Otología Otologia	727-760
035	Rhinologie Rhinology Rinología Rinologia	761-806
037	Mund-, Kiefer- und Gesichtschirurgie Oral Maxillo-Facial Surgery Cirugía oral y maxilofacial Chirurgia maxillo-facciale	807-848
046	Dermatologie Dermatology Dermatología Dermatologia	849-856
085	Sterilisation, Hygiene, Aufbewahrung Sterilisation, Hygiene, Storage Esterilización, Hiegiene, Almacenaje Sterillizzazione, Magazzinaggio	857-886

Suction Units



01

S30
large volume

02

M20D
large volume

Negative Pressure Wound Therapy



01 **SIM^{EX}200**
mobility miracle

02 **SIM^{EX}300**
large volume

Subglottic Aspiration System



01 **cuff M**
mobility miracle

02 **cuff S**
large volume

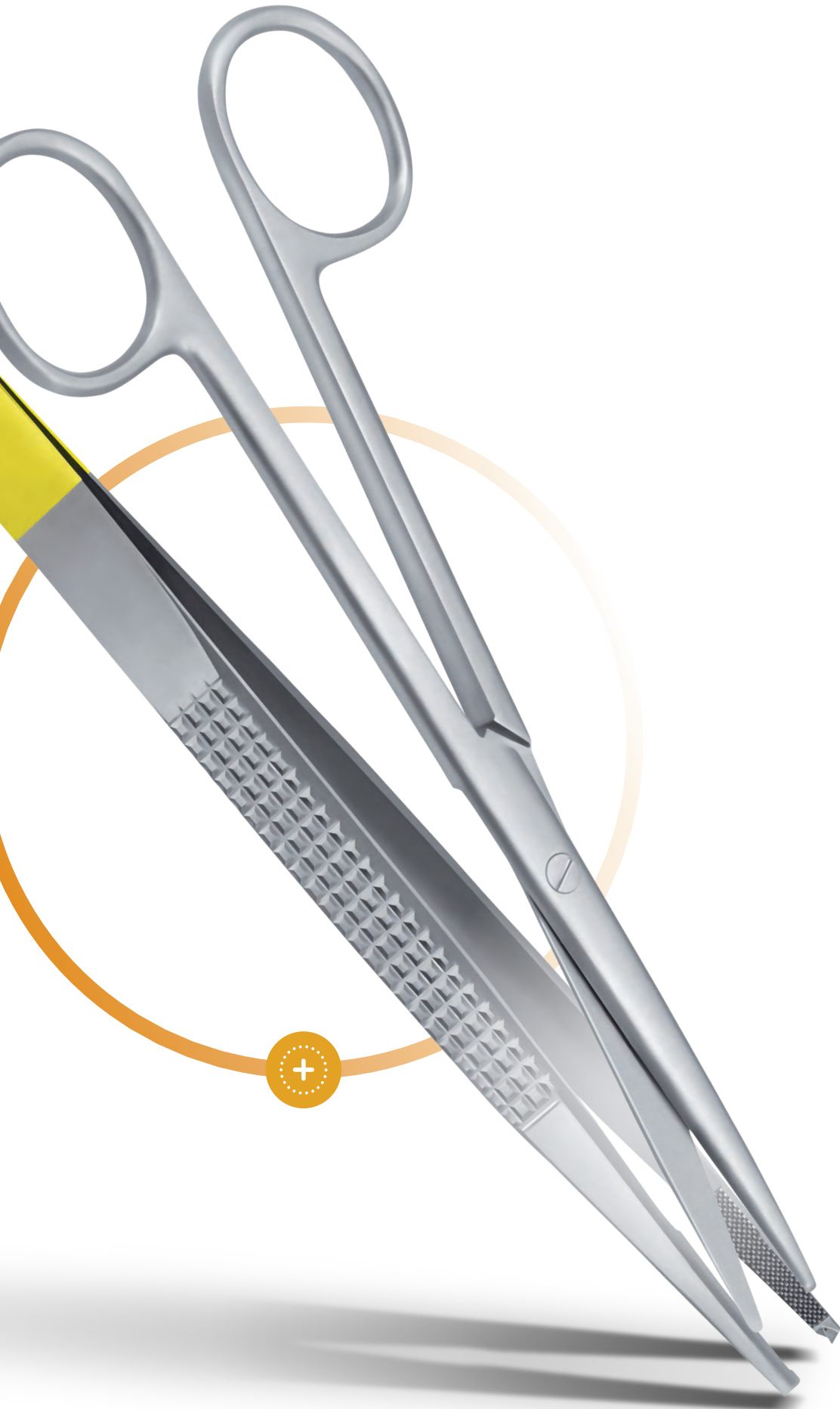

0113-0301

Artikelgruppe / Disziplin

Product Group / Discipline
Grupo de artículo / Disciplina
Gruppo di articolo / Disciplina

Größe / Figur des Instruments

Size / Shape of the instrument
Tamaño / Forma del instrumento
Dimensione / Forma dello strumento

Artikel-Nummer

Item number
N° del artículo
Codice articolo

Detail des Instruments

Detail of the instrument
Detalle del instrumento
Dettaglio dello strumento

Maße

Dimensions
Dimensiones
Dimensioni

Autor

Author
Autor
Autore

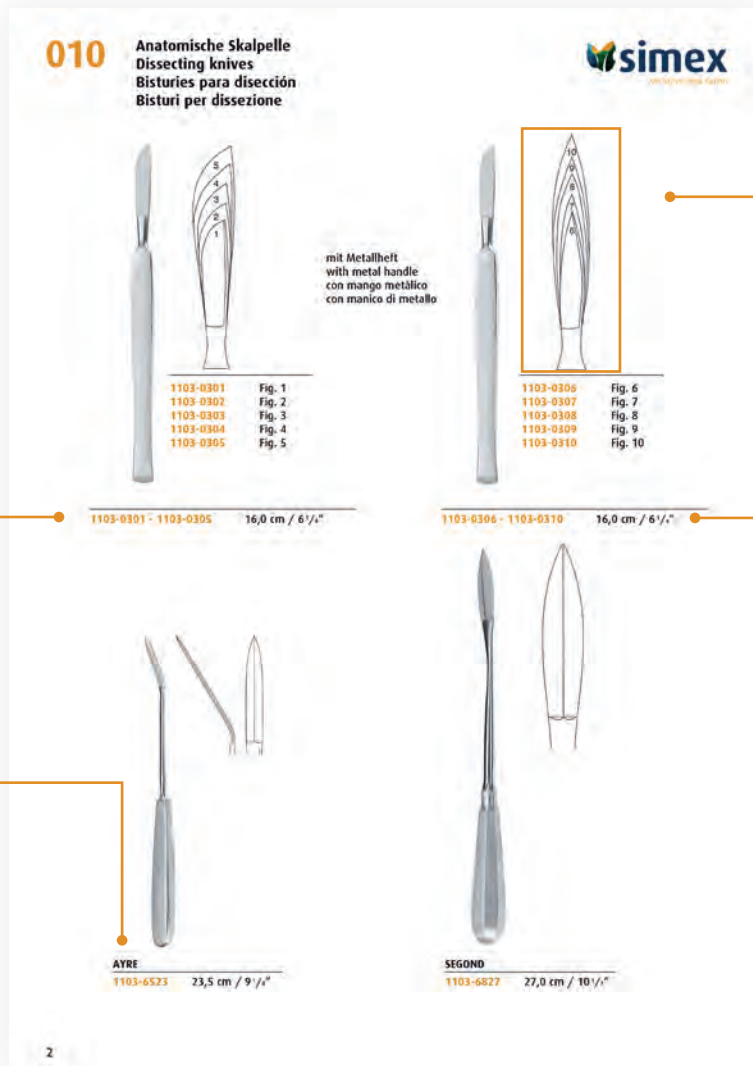

010

**Skalpelle und Messer
Scalpes and Knives
Bisturies y Cuchillos
Bisturi e Coltelli**



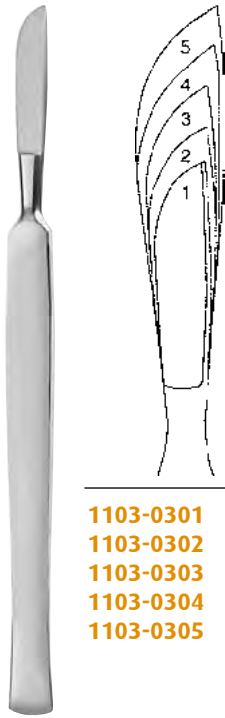

1103-0301 Fig. 1
1103-0302 Fig. 2
1103-0303 Fig. 3
1103-0304 Fig. 4
1103-0305 Fig. 5

mit Metallheft
 with metal handle
 con mango metálico
 con manico di metallo

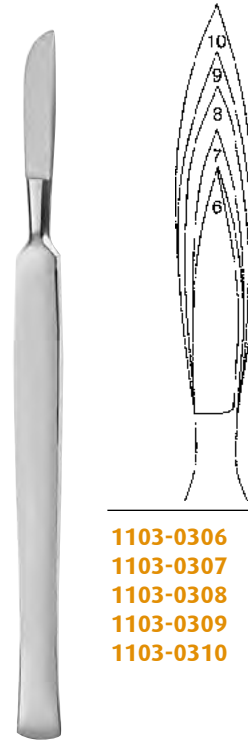

1103-0306 Fig. 6
1103-0307 Fig. 7
1103-0308 Fig. 8
1103-0309 Fig. 9
1103-0310 Fig. 10

1103-0301 - 1103-0305 16,0 cm / 6 1/4"

1103-0306 - 1103-0310 16,0 cm / 6 1/4"

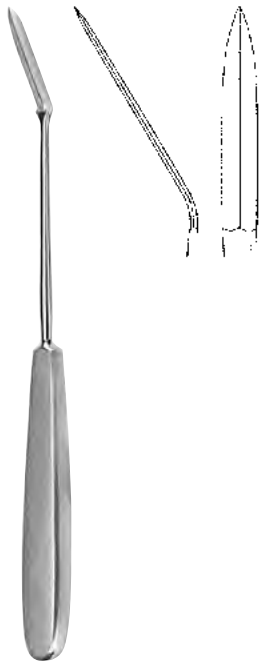

AYRE
1103-6523 23,5 cm / 9 1/4"

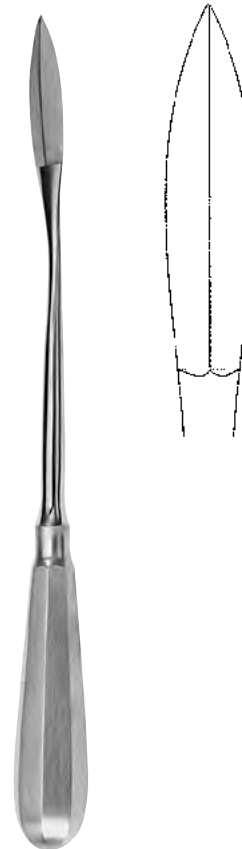

SEGOND
1103-6827 27,0 cm / 10 1/2"

Seziermesser, Knorpelmesser,
Autopsy knives, Cartilage knives
Cuchillos para autopsia, cuchillos para cartilago
Coltelli per autopsia, coltelli per cartilagini

010

Mit Holzheft
with wooden handle
con mango de madera
con manico di legno



VIRCHOW

1103-3701 21,0 cm / 8¹/₄"



1103-4011 25,5 cm / 10"

Mit Metallheft
with metal handle
con mango metálico
con manico di metallo

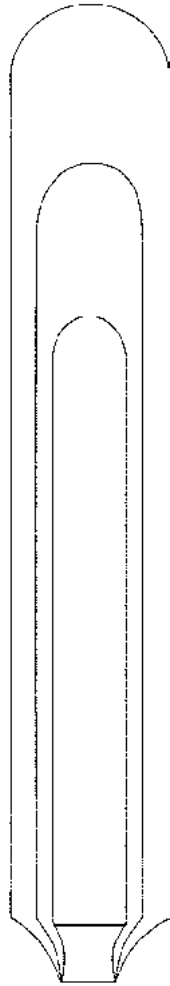

VIRCHOW

1103-6016	16,0 cm, 6 ¹ / ₄ "
1103-6020	20,0 cm, 8"
1103-6024	24,0 cm, 9 ¹ / ₂ "

Mit Holzheft
with wooden handle
con mango de madera
con manico di legno



WALB

1103-5011	11,0 cm, 4 ¹ / ₃ "
1103-5014	14,0 cm, 5 ¹ / ₂ "
1103-5017	17,0 cm, 6 ⁴ / ₃ "



massiv
 solid
 macizo
 pieno

STANDARD Nr. 3

1101-0301 12,0 cm / 4³/₄"



massiv
 solid
 macizo
 pieno

mit cm - Graduierung
 with cm - graduiation
 graduado en cm
 graduato in cm

Nr. 3

1101-0303 12,0 cm / 4³/₄"



massiv
 solid
 macizo
 pieno

STANDARD Nr. 4

1101-0401 12,0 cm / 4³/₄"



massiv
 solid
 macizo
 pieno
 gerade
 straight
 recto
 retto

Nr. 3L

1101-0304 21,5 cm / 8¹/₂"

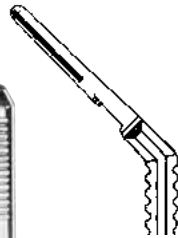

massiv
 solid
 macizo
 pieno
 abgewinkelt
 angled
 acodado
 angolare

Nr. 3L

1101-0305 21,0 cm / 8¹/₄"



Nr. 3

1101-0308 21,5 cm / 8¹/₂"



Nr. 3

1101-0309 21,5 cm / 8¹/₂"



massiv
solid
macizo
pieno

Doppelgriff
Double Hand
Mango doble
Manico doppio

Nr. 3 + 4
1101-0334 16,0 cm / 6¹/₄"



massiv
solid
macizo
pieno
gerade
straight
recto
retto

Nr. 4L
1101-0404 21,5 cm / 8¹/₂"



massiv
solid
macizo
pieno
abgewinkelt
angled
acodado
angolare

Nr. 4L
1101-0405 21,0 cm / 8¹/₄"



Nr. 4
1101-0408 22 cm / 8³/₄"



massiv
solid
macizo
pieno

Nr. 7
1101-0700 16 cm / 6¹/₄"



massiv
solid
macizo
pieno

Nr. 7K
1101-0307 12,5 cm / 5"



hohl, rund
hollow, round
hueco, redondo
vuoto, rotondo

1101-0311 15,5 cm / 6"

steril
 serile
 estériles
 sterile



Fig. 10
 1101-5310



Fig. 11
 1101-5311



Fig. 12
 1101-5312



Fig. 13
 1101-5313



Fig. 14
 1101-5314



Fig. 15
 1101-5315

passend für Skalpellsgriffe / for scalpel handles / para mangos / per i manici
 1101-0700

steril
 serile
 estériles
 sterile



Fig. 16
 1101-5316



Fig. 17
 1101-5317



Fig. 12d
 1101-5312 D



Fig. 15c
 1101-5315 C

* doppelschneidig
 double cutting edge
 dos filos de corte
 Filo doppio

steril
serile
estériles
sterile

passend für Skalpellgriffe / for scalpel handles / para mangos / per i manici .
1101-0401



Fig. 18
1101-5418



Fig. 19
1101-5419

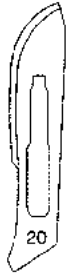

Fig. 20
1101-5420

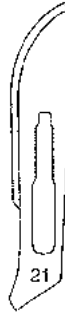

Fig. 21
1101-5421



Fig. 22
1101-5422



Fig. 23
1101-5423



Fig. 24
1101-5424

steril
serile
estériles
sterile

* doppelschneidig
double cutting edge
dos filos de corte
Filo doppio



Fig. 25
1101-5425

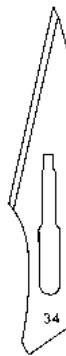

Fig. 34
1101-5434



Fig. 36
1101-5436



Fig. 24d
1101-5424 D

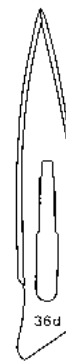
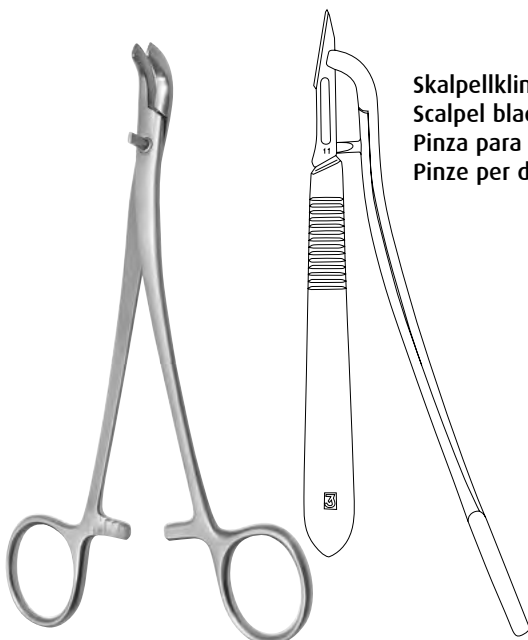

Fig. 36d
1101-5436 D



Skalpellklingen-Entfernungszange
Scalpel blade removing forceps
Pinza para quitar hojas de bisturíes
Pinze per distribuire lame die bisturi



Skalpellklingen-Entferner
Scalpel-Blade Remover
Quita hojas
Distributore lame

1101-9900

1101-8016 16 cm / 6 1/4"



Dermatom, einstellbar von 0,1 bis 2,0 mm, komplett, mit 1 auswechselbarer Klinge und 2 Spannplatten.
 Dermeatome, adjustable from 0,1 to 2,0 mm, compl., with 1 interchangeable blade and 2 skin straightening blades
 Dermatomo, graduable de 0,1 hasta 2,0 mm, completo, con 1 hoja intercambiable y 2 placas para extender la piel
 Dermatomi regolabile da 0,1 a 2,0 mm, completo con 2 placche per stendere la pelle ed una lama.

Ersatzklinge
 Spare blade
 Hoja de repuesto
 Lama di ricambio



Spannplatte allein
 Skin straightening plate only
 Placa para extender la piel
 Placca per stendere la pelle



SCHINK

1104-0000 31,0 cm / 12¹/₄"

1104-0001

1104-0002



für handelsübliche Rasierklinge
 for razor blades standard model in trade
 para hojas de afeitar de uso corriente en el comercio
 Per lamette da barba normali

Ersatzklinge
 Spare blade
 Hoja de repuesto
 Lama di ricambio

1104-0432



SILVER

1104-0219 19,0 cm / 7¹/₂"

HUMBY

1104-0431 32,0 cm / 12¹/₂"



COLIN	A
1103-2013	13,0 cm / 5 ¹ / ₈ "
1103-2016	16,0 cm / 6 ¹ / ₄ "
1103-2019	19,0 cm / 7 ¹ / ₂ "
1103-2022	22,0 cm / 8 ¹ / ₂ "
1103-2028	28,0 cm / 11 ¹ / ₄ "

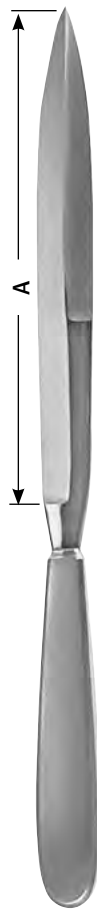

CATLIN	A
1103-2216	16,0 cm / 6 ¹ / ₄ "
1103-2219	19,0 cm / 7 ¹ / ₂ "
1103-2222	22,0 cm / 8 ³ / ₄ "

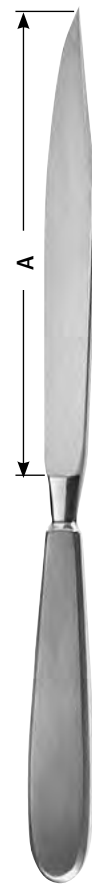

LISTON	A
1103-2817	17,0 cm / 6 ³ / ₄ "
1103-2820	20,0 cm / 8"

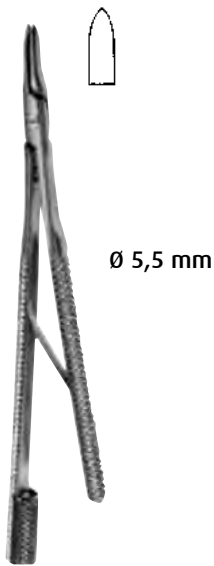

Ø 5,5 mm

TROUTMAN-CHRIS

1101-1010 9,0 cm / 3 1/2"



Ø 5,5 mm

TROUTMAN-CHRIS

1101-1110 9,0 cm / 3 1/2"



CASTROVIEJO

1101-1211 11,0 cm / 4 1/2"



Ø 8,0 mm

CASTROVIEJO

1101-1413 13,0 cm / 5 1/4"

Rasierklingen, brechbar, rostfrei, in Packungen zu 10 Stück.

Razor blades, breakable, stainless steel, in packages of 10 pieces.

Hojas de afeitar, rompibles de acero inoxidable, en paquetes de 10 piezas.

Lamette di rasoio, per rompere, acciaio inossidabile, scatola di 10 pezzi



1101-1600

011

**Mikro-Scheren
Micro Scissors
Micro Tijeras
Micro Forbici**

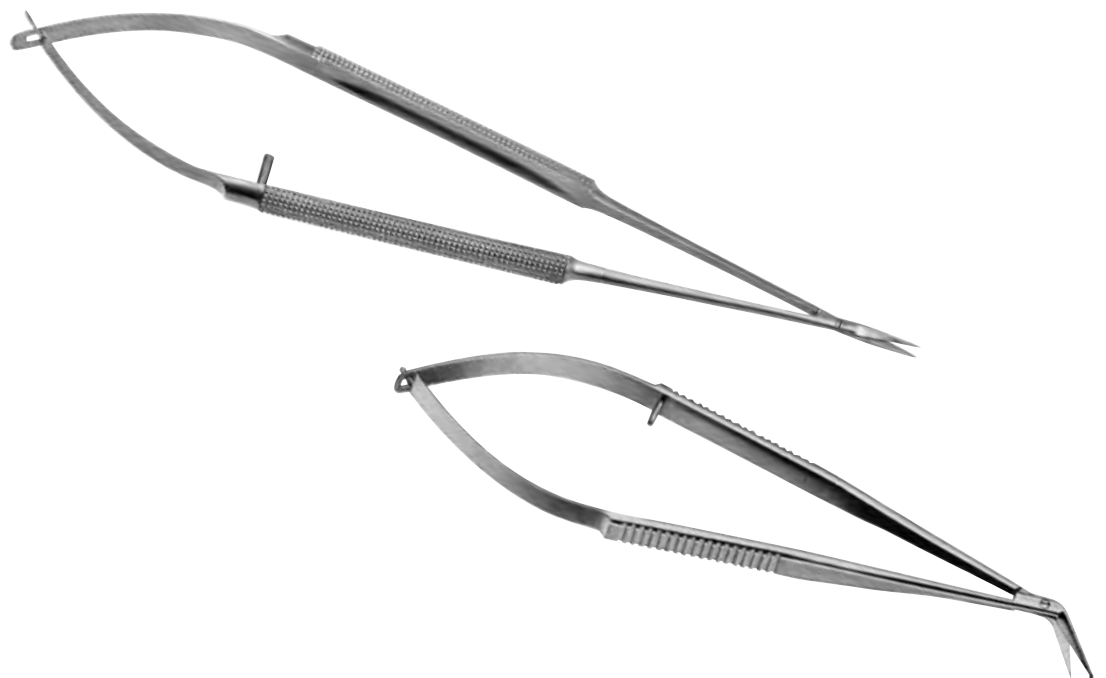

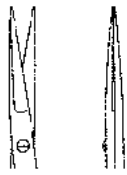

1116-0219



1116-0319

aufgebogen
 curved
 curva
 curve in alto



1116-0419

abgebogen
 cur. downward
 curva hacia abajo
 curve basso



1116-0519

abgewinkelt
 angled
 acodada
 angolato

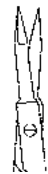

1116-1019



1116-1119

1116-0219 - 1116-1119

18,5 cm / 7 1/2"



JACOBSON
1116-0623



1116-1223



POTTS
1116-0723



1116-1323

1116-0623 - 1116-1323

22,5 cm / 8 3/4"



1116-1418



1116-1518



011-113-185

1116-1418 - 1116-1618

18,5 cm / 7 1/2"

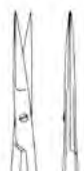

1116-3011



1116-3111

WESTCOTT

1116-3011 11,5 cm / 8³/₄"
1116-3111 11,5 cm / 8³/₄"

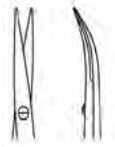

1116-8511 11,0 cm / 4¹/₂"



1116-3211 12,0 cm / 5"



GOMEL

1116-8914 14,0 cm / 5¹/₂"
1106-8918 18,0 cm / 6¹/₄"

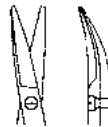

HEPP/SCHIEDEL

1116-9114 14,0 cm / 5¹/₂"
1116-9116 16,0 cm / 6¹/₄"

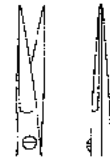

1116-1409



1116-1609

1116-1409 9,0 cm / 3¹/₂"
1116-1609 9,0 cm / 3¹/₂"

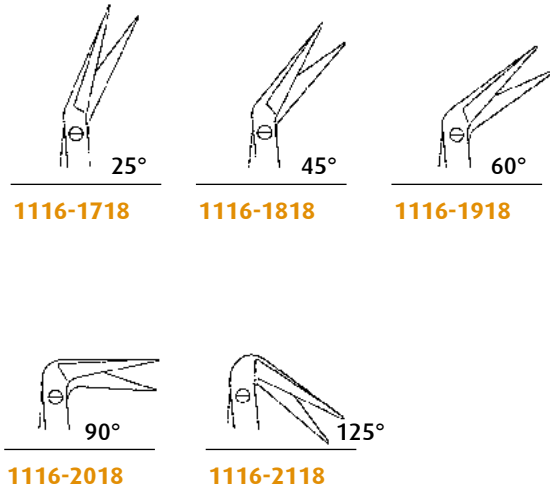

1116-1718 - 1116-2118 18,0 cm / 7"

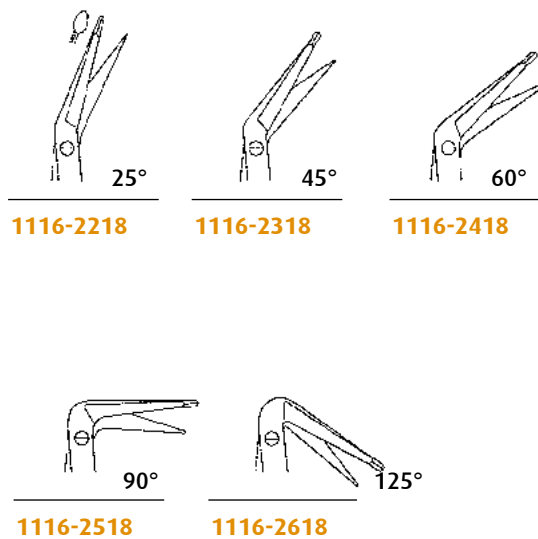

1 Blatt geknöpft
1 probe-pointed blade
1 hoja botonada
1 lama bottonuta

1116-2218 - 1116-2618 18,0 cm / 7"

Mikro-Scheren
Micro Scissors
Micro Tijeras
Micro Forbici



1116-2814



1116-2915



REILL

1116-2916

1 Blatt gezahnt
 1 blade saw edge
 1 hoja dentada
 1 lama dentata



1116-8818



1116-9018

1 Blatt gezahnt
 1 blade saw edge
 1 hoja dentada
 1 lama dentata

1116-2814 14 cm / 5 1/2"
1116-2915 15,5 cm / 6"
1116-2916 15,5 cm / 6"

1116-8818 18,0 cm / 7 1/4"
1116-9018 18,0 cm / 7 1/4"



HEPP/SCHIEDL

1116-8618 18,0 cm / 7 1/4"



1116-8518 18,0 cm / 7 1/4"



HEPP/SCHIEDL

1116-8718 18,0 cm / 7 1/4"

012

**Scheren
Scissors
Tijeras
Forbici**



gerade • straight • rectas • retto



STANDARD

1110-0010	10,5 cm / 4 ¹ / ₄ "
1110-0011	11,5 cm / 4 ¹ / ₂ "
1110-0013	13,0 cm / 5 ¹ / ₈ "
1110-0014	14,5 cm / 5 ³ / ₄ "
1110-0015	15,5 cm / 6"
1110-0016	16,5 cm / 6 ¹ / ₂ "
1110-0017	17,5 cm / 7"
1110-0018	18,5 cm / 7 ¹ / ₄ "
1110-0020	20,0 cm / 8"

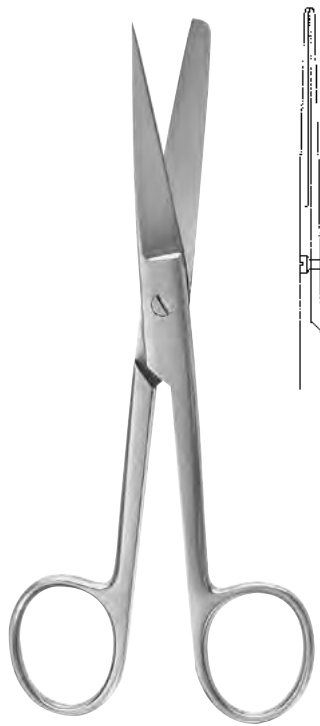

STANDARD

1110-0210	10,5 cm / 4 ¹ / ₄ "
1110-0211	11,5 cm / 4 ¹ / ₂ "
1110-0213	13,0 cm / 5 ¹ / ₈ "
1110-0214	14,5 cm / 5 ³ / ₄ "
1110-0215	15,5 cm / 6"
1110-0216	16,5 cm / 6 ¹ / ₂ "
1110-0217	17,5 cm / 7"
1110-0218	18,5 cm / 7 ¹ / ₄ "
1110-0220	20,0 cm / 8"

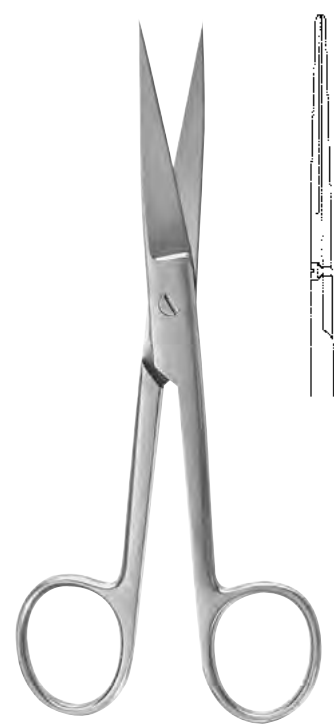

STANDARD

1110-0410	10,5 cm / 4 ¹ / ₄ "
1110-0411	11,5 cm / 4 ¹ / ₂ "
1110-0413	13,0 cm / 5 ¹ / ₈ "
1110-0414	14,5 cm / 5 ³ / ₄ "
1110-0415	15,5 cm / 6"
1110-0416	16,5 cm / 6 ¹ / ₂ "
1110-0417	17,5 cm / 7"
1110-0418	18,5 cm / 7 ¹ / ₄ "
1110-0420	20,0 cm / 8"

gebogen • curved • curvas • curve



STANDARD

1110-0111	11,5 cm / 4 1/2"
1110-0113	13,0 cm / 5 1/8"
1110-0114	14,5 cm / 5 3/4"
1110-0115	15,5 cm / 6"
1110-0116	16,5 cm / 6 1/2"
1110-0117	17,5 cm / 7"
1110-0118	18,5 cm / 7 1/4"
1110-0120	20,0 cm / 8"



STANDARD

1110-0311	11,5 cm / 4 1/2"
1110-0313	13,0 cm / 5 1/8"
1110-0314	14,5 cm / 5 3/4"
1110-0315	15,5 cm / 6"
1110-0316	16,5 cm / 6 1/2"
1110-0317	17,5 cm / 7"
1110-0318	18,5 cm / 7 1/4"
1110-0320	20,0 cm / 8"



STANDARD

1110-0511	11,5 cm / 4 1/2"
1110-0513	13,0 cm / 5 1/8"
1110-0514	14,5 cm / 5 3/4"
1110-0515	15,5 cm / 6"
1110-0516	16,5 cm / 6 1/2"
1110-0517	17,5 cm / 7"
1110-0518	18,5 cm / 7 1/4"
1110-0520	20,0 cm / 8"

**GRAZIL**

1110-1013 13,0 cm / 5¹/₈"
1110-1014 14,5 cm / 5³/₄"

**GRAZIL**

1110-1113 13,0 cm / 5¹/₈"
1110-1114 14,5 cm / 5³/₄"

**GRAZIL**

1110-1213 13,0 cm / 5¹/₈"
1110-1214 14,5 cm / 5³/₄"

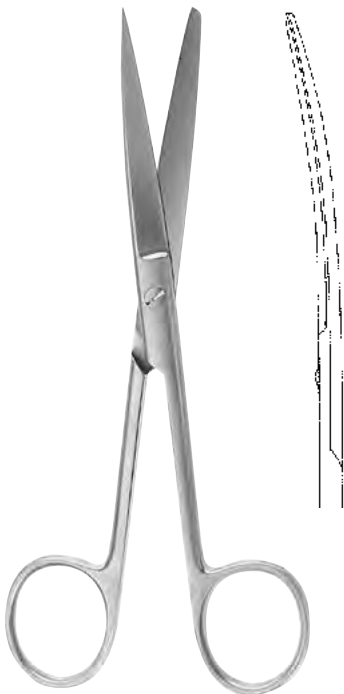
**GRAZIL**

1110-1313 13,0 cm / 5¹/₈"
1110-1314 14,5 cm / 5³/₄"

**GRAZIL**

1110-1413 13,0 cm / 5¹/₈"
1110-1414 14,5 cm / 5³/₄"

**GRAZIL**

1110-1513 13,0 cm / 5¹/₈"
1110-1514 14,5 cm / 5³/₄"



INCISION

- 1111-0013** 13,0 cm / 5¹/₈"
- 1111-0014** 14,5 cm / 5³/₄"

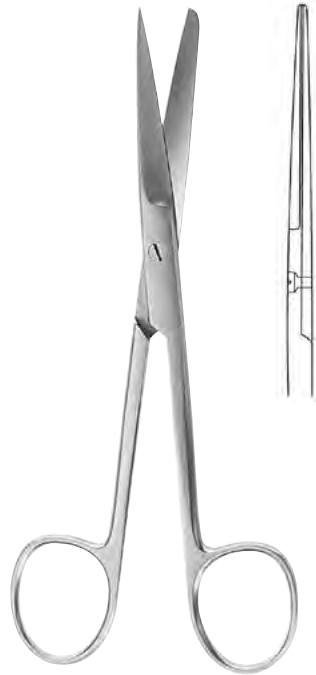

DEAVER

- 1111-0414** 14,0 cm / 5¹/₂"

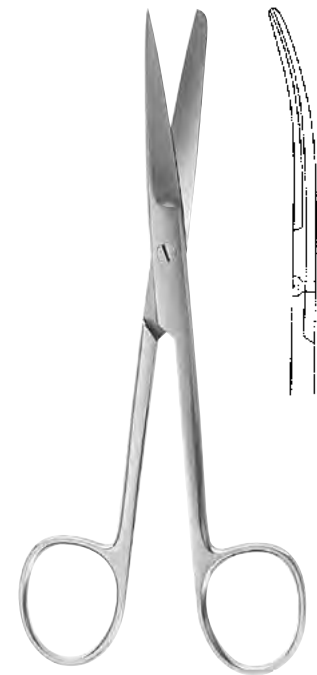

DEAVER

- 1111-0514** 14,0 cm / 5¹/₂"



MAYO

- 1111-6014** 14,5 cm / 5³/₄"
- 1111-6015** 15,5 cm / 6"
- 1111-6017** 17,0 cm / 6³/₄"
- 1111-6023** 23,0 cm / 9"

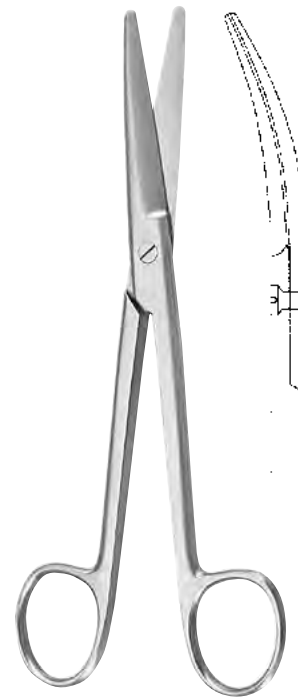

MAYO

- 1111-6114** 14,5 cm / 5³/₄"
- 1111-6115** 15,5 cm / 6"
- 1111-6117** 17,0 cm / 6³/₄"
- 1111-6123** 23,0 cm / 9"

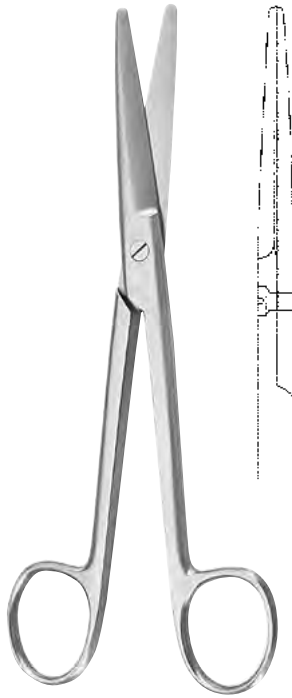

MAYO-HARRINGTON

1111-6622 22,5 cm / 9"

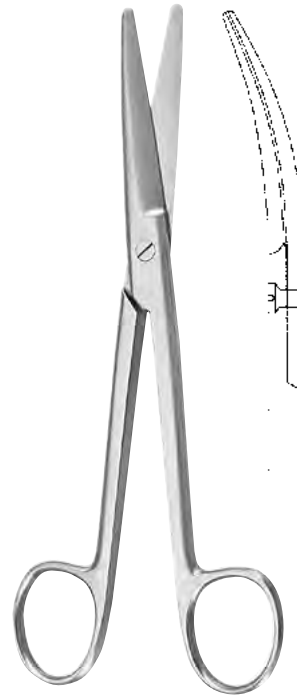

MAYO-HARRINGTON

1111-6722 22,5 cm / 9"
1111-6628 28,0 cm / 11"



MAYO-STILLE

1111-7015 15,0 cm / 6"
1111-7017 17,0 cm / 6³/₄"
1111-7019 19,0 cm / 7¹/₂"
1111-7021 21,0 cm / 8¹/₄"

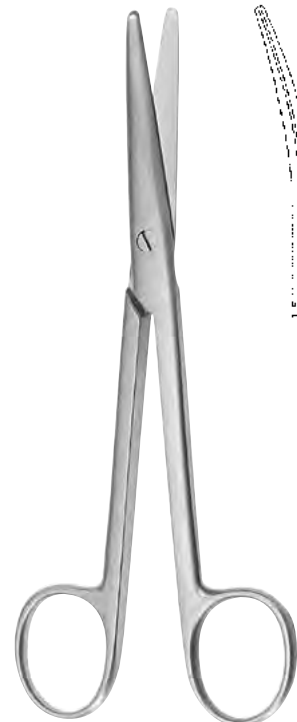

MAYO-STILLE

1111-7115 15,0 cm / 6"
1111-7117 17,0 cm / 6³/₄"
1111-7119 19,0 cm / 7¹/₂"
1111-7121 21,0 cm / 8¹/₄"

Chirurgische Scheren, Gynäkologische Scheren
Surgical Scissors, Gynecological Scissors
Tijeras para cirugía, Tijeras para ginecología
Forbici per chirurgia, Forbici per ginecologia

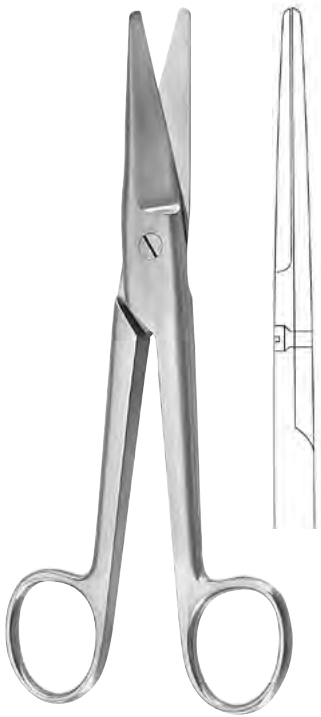

MAYO-NOBLE

1111-7617 17,0 cm / 6³/₄"



MAYO-NOBLE

1111-7717 17,0 cm / 6³/₄"

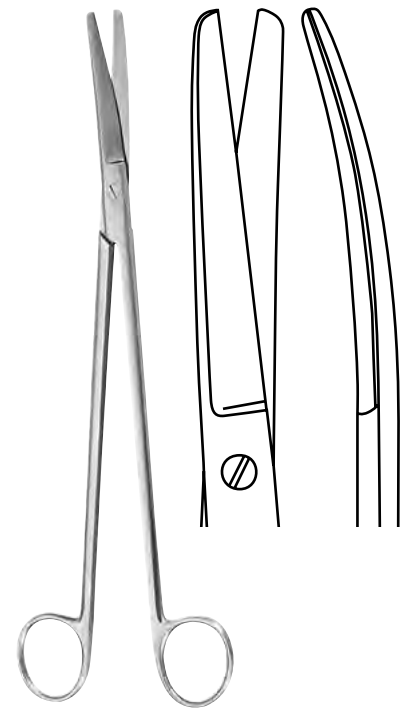

WERTHEIM

1111-3114 14,5 cm / 5¹/₂"
1111-3120 19,5 cm / 7³/₄"
1111-3122 22,5 cm / 9"

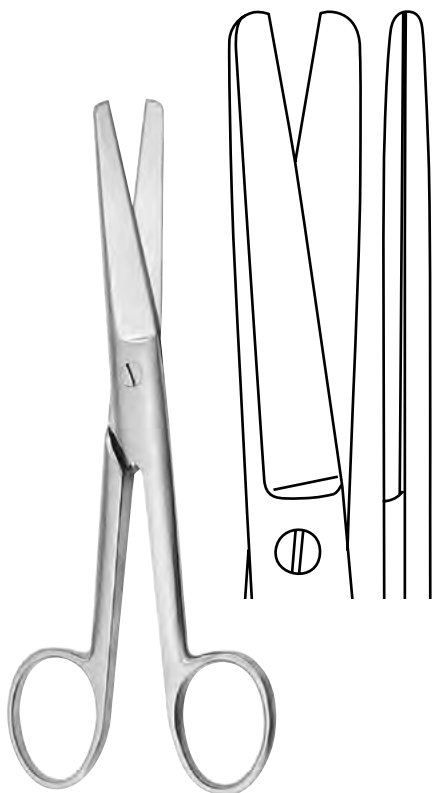

DOYEN

1111-1418 17,5 cm / 7"

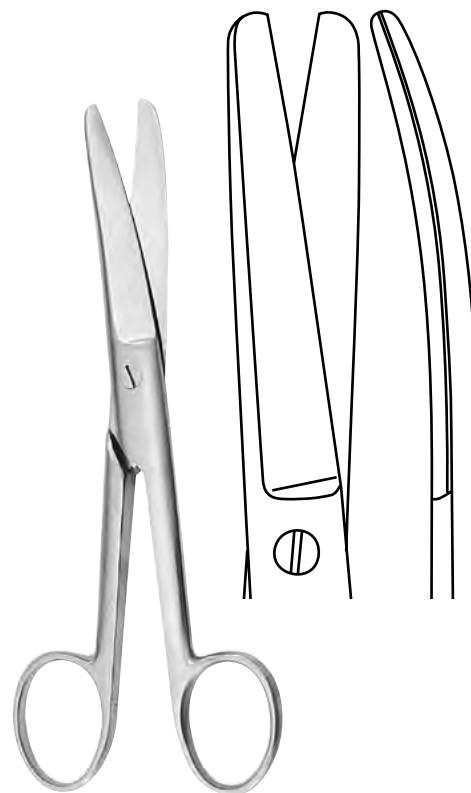

DOYEN

1111-1518 17,5 cm / 7"

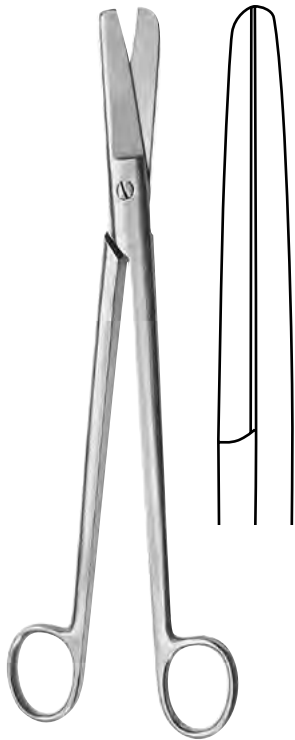

DUBOIS

1111-3227 27,0 cm / 10⁵/₈"

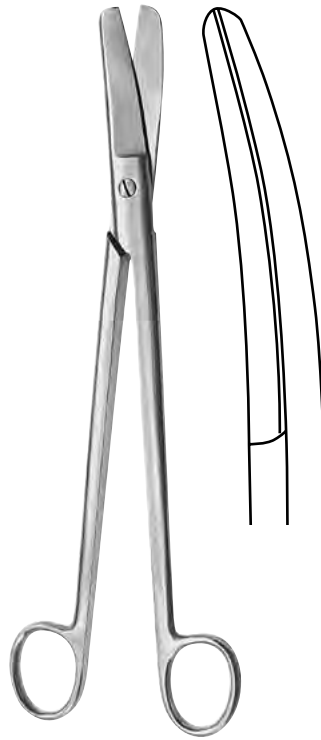

DUBOIS

1111-3327 27,0 cm / 10⁵/₈"



BOZEMANN

1115-0222 22,0 cm / 8³/₄"



SIEBOLD

1111-2724 24,0 cm / 9¹/₂"

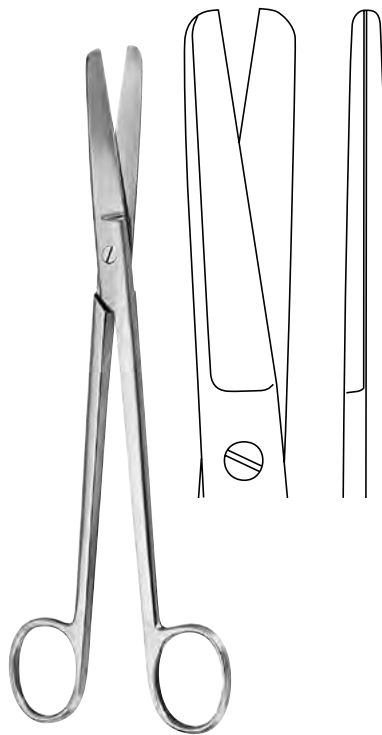

SIMS

1111-2020 20,0 cm / 8"
1111-2023 23,0 cm / 9"

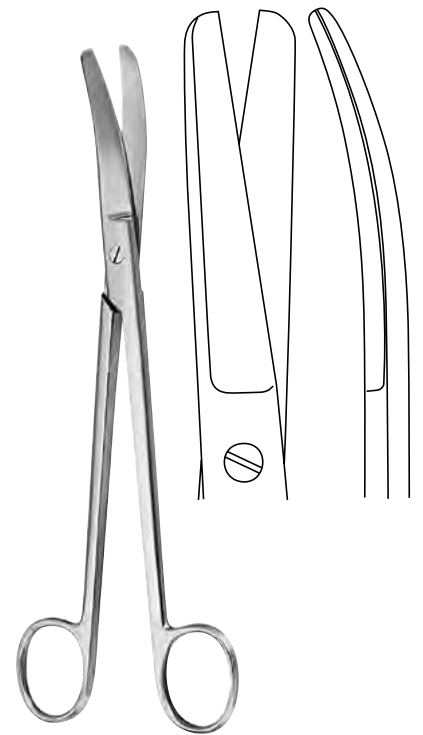

SIMS

1111-2120 20,0 cm / 8"
1111-2123 23,0 cm / 9"

Gynäkologische Scheren / Nabelschnurscheren
 Gynecological Scissors / Umbilical Scissors
 Tijeras para ginecología / Tijeras umbilicales
 Forbici per ginecologia / Forbici ombelicali

012



BRAUN-STADLER

1111-3914 14,0 cm / 5 1/2"
 1111-3922 22,0 cm / 8 3/4"



BUSCH

1111-4713 13,0 cm / 5 1/8"
 1111-4716 16,0 cm / 6 1/4"



MOD. USA

1111-4410 10,5 cm / 4 1/8"



SCHUMACHER

1111-4516 16,0 cm / 6 1/4"



WALDMANN

1111-4118 18,0 cm / 7"



1111-4120 20,0 cm / 8"

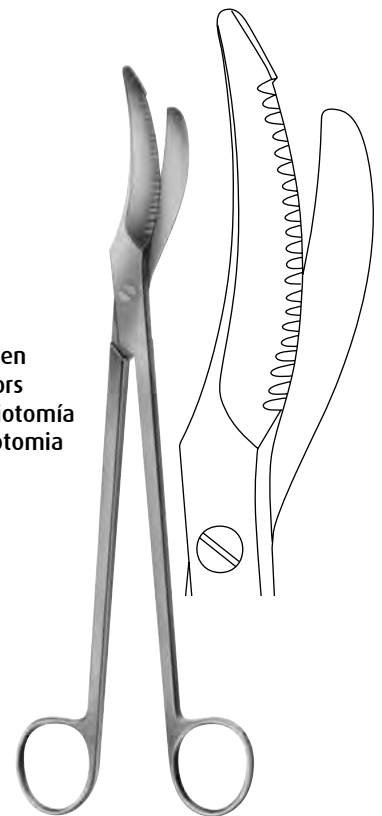

1111-4924 24,0 cm / 9 1/2"

Episiotomiescheren
 Episiotomy scissors
 Tijeras para episiotomía
 Forbici per episiotomia

Episiotomiescheren
 Episiotomy scissors
 Tijeras para episiotomía
 Forbici per episiotomia

gezahnt
 toothed
 dentada
 dentate



METZENBAUM-BABY

1112-2811 11,5 cm / 4 1/2"



METZENBAUM-BABY

1112-1112 11,5 cm / 4 1/2"



1112-0014

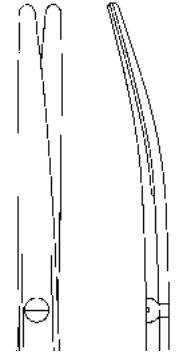

1112-0114

METZENBAUM

1112-0014 - 1112-0114 14,5 cm / 5 1/2"

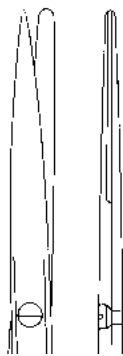

1112-0214



1112-0314

METZENBAUM

1112-0214 - 1112-0314 14,5 cm / 5 1/2"

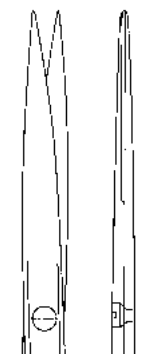

1112-0414

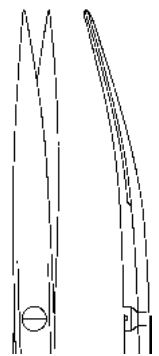

1112-0514

METZENBAUM

1112-0414 - 1112-0514 14,5 cm / 5 1/2"



METZENBAUM-NELSON

1112-0018	18,0 cm / 7"
1112-0020	20,0 cm / 8"
1112-0023	23,0 cm / 9"
1112-0025	25,0 cm / 10"
1112-0028	28,0 cm / 11"
1112-0030	30,0 cm / 12"

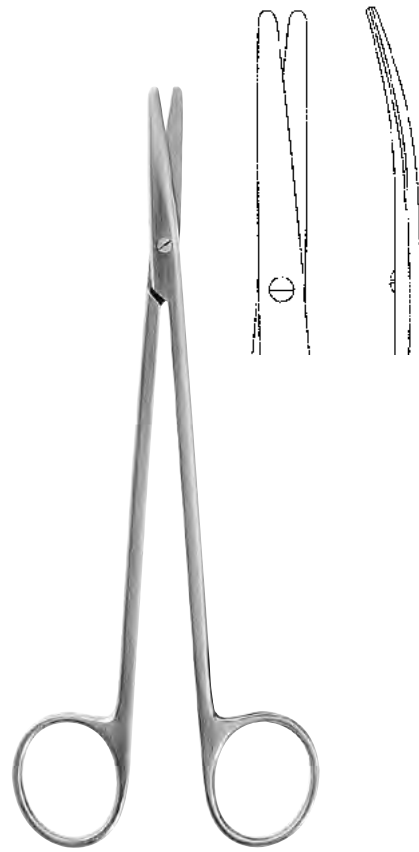

METZENBAUM-NELSON

1112-0118	18,0 cm / 7"
1112-0120	20,0 cm / 8"
1112-0123	23,0 cm / 9"
1112-0125	25,0 cm / 10"
1112-0128	28,0 cm / 11"
1112-0130	30,0 cm / 12"

Nerv-Präparierscheren • Nerve-Dissecting Scissors
Tijeras para disección de nervios • Forbici per nervi



1112-0615 15,0 cm / 6"



1112-0715 15,0 cm / 6"

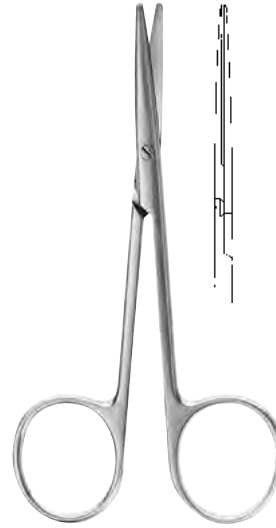

LEXER-BABY
1112-3410 10,0 cm / 4"

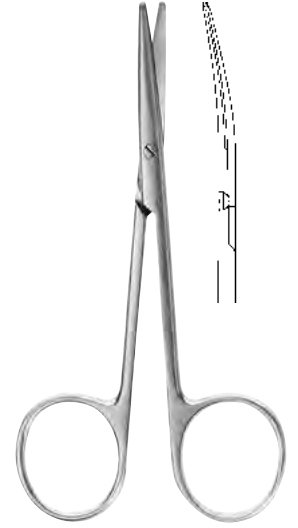

LEXER-BABY
1112-3510 10,0 cm / 4"



LEXER
1112-3016 16,0 cm / 6 1/4"
1112-3021 21,0 cm / 8 1/4"



LEXER
1112-3116 16,0 cm / 6 1/4"
1112-3120 21,0 cm / 8 1/4"

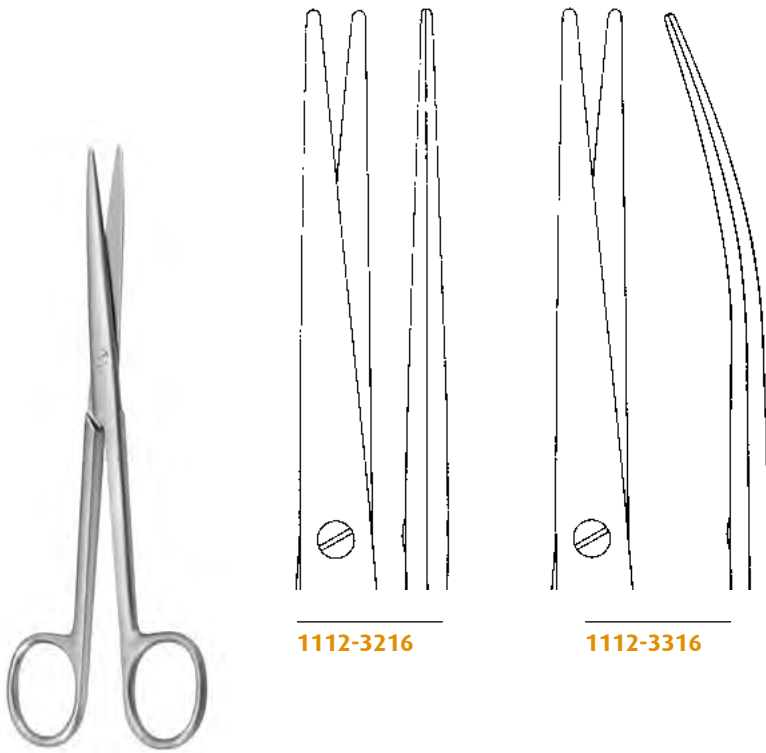

LEXER-FINO

1112-3216 - 1112-3316

16,0 cm / 6¹/₄"

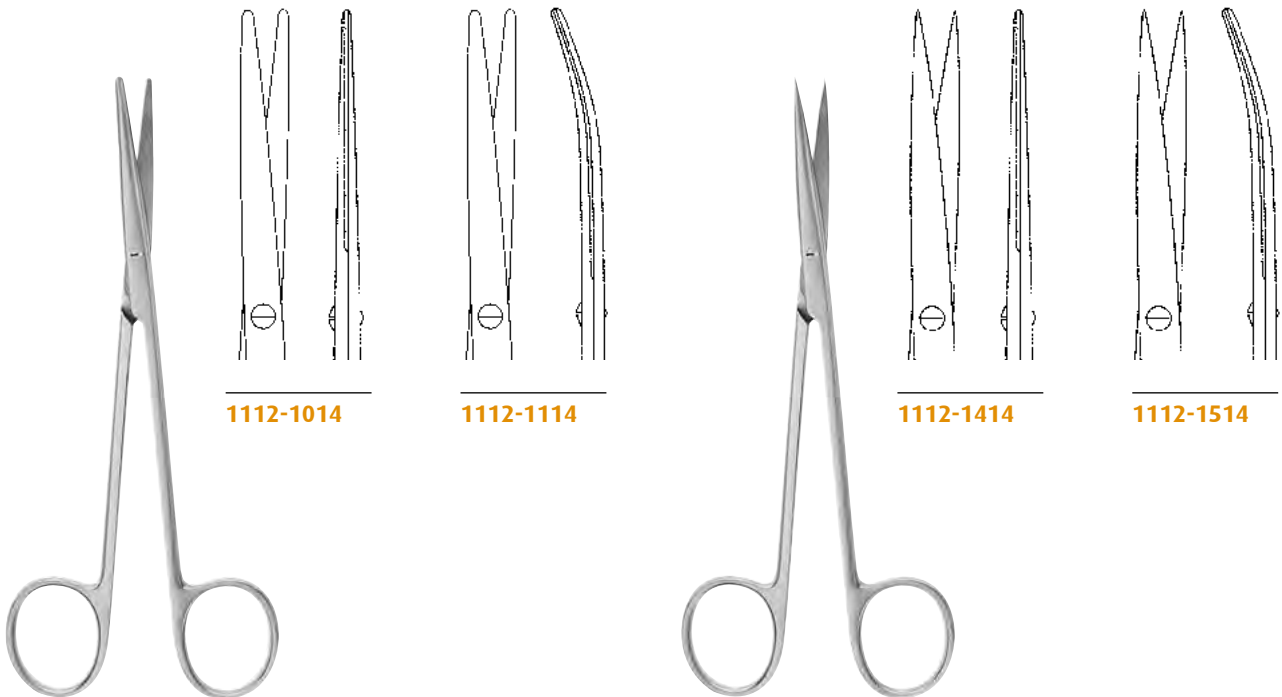

METZENBAUM-FINO

1112-1014 - 1112-1114

14,5 cm / 5³/₄"

METZENBAUM-FINO

1112-1414 - 1112-1514

14,5 cm / 5³/₄"

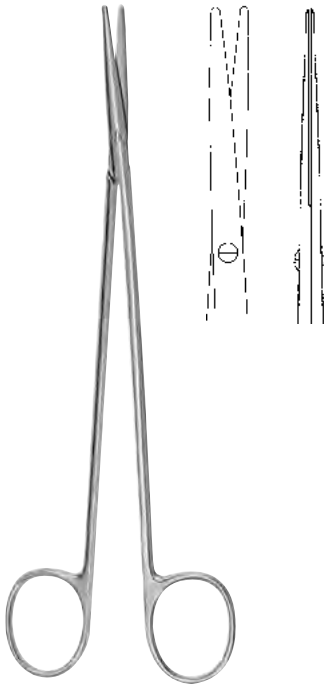

METZENBAUM-FINO

- 1112-1018** 18,0 cm / 7"
- 1112-1020** 20,0 cm / 8"
- 1112-1023** 23,0 cm / 9"

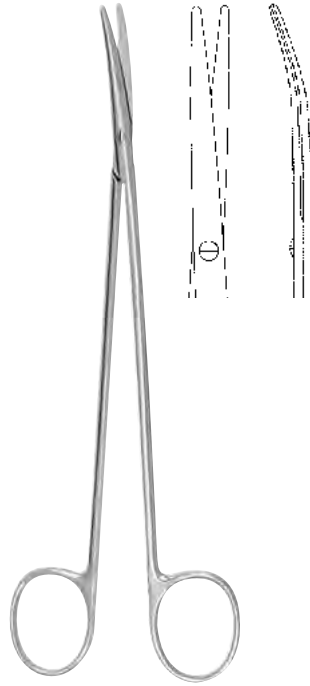

METZENBAUM-FINO

- 1112-1118** 18,0 cm / 7"
- 1112-1120** 20,0 cm / 8"
- 1112-1123** 23,0 cm / 9"

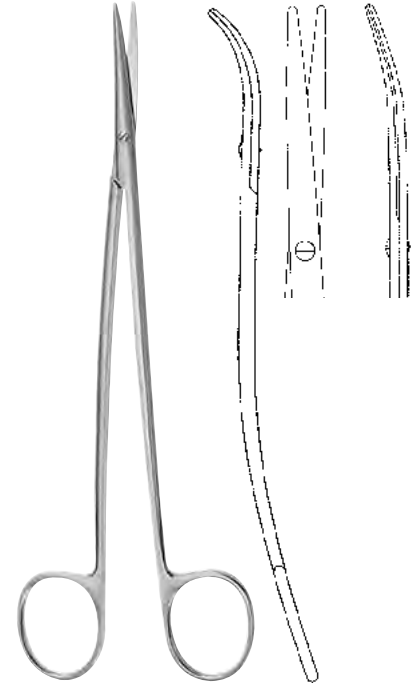

METZENBAUM-FINO S

- 1112-2118** 18,0 cm / 7"
- 1112-2120** 20,0 cm / 8"
- 1112-2123** 23,0 cm / 9"

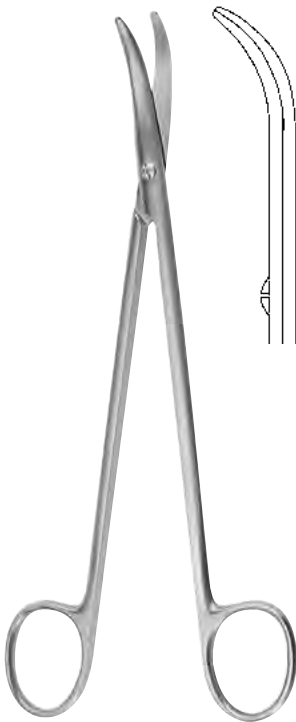

THOREK

- 1112-4119** 19,0 cm / 7 1/2"

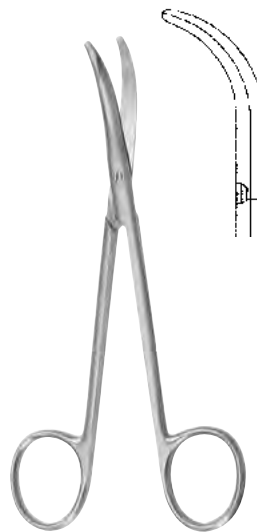

FOMON

- 1113-2113** 13,5 cm / 5 1/8"



ENUCLEATION

- 1113-4412** 11,0 cm / 4 3/8"

Feine chirurgische Scheren
Delicate Surgical Scissors
Tijeras finas para cirugía
Forbici fine per chirurgia



LANDOLT

1113-4512 12,5 cm / 5"



LANDOLT

1113-4511 12,5 cm / 5"



KILNER

1112-4512 12,0 cm / 4³/₄"
1112-4515 15,0 cm / 6"

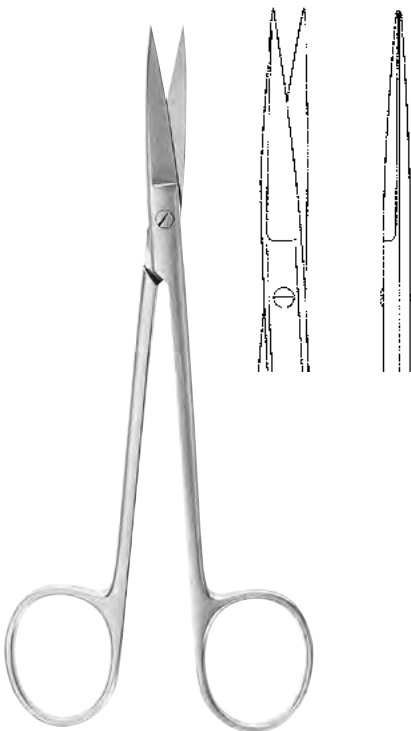

JOSEPH

1114-0414 14,0 cm / 5¹/₂"

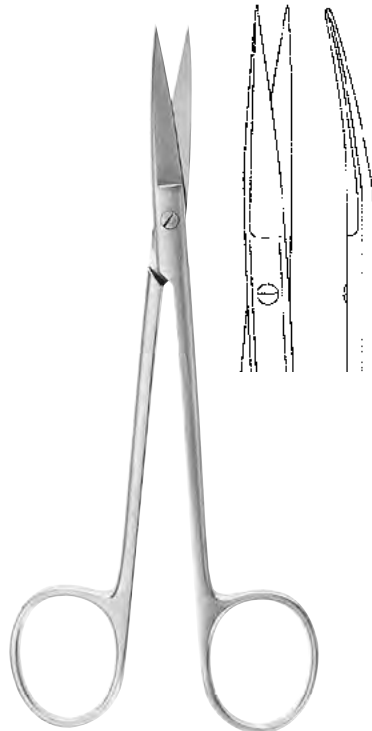

JOSEPH

1114-0514 14,0 cm / 5¹/₂"



BROPHY-SULLIVAN

1114-1015 14,0 cm / 5 1/2"

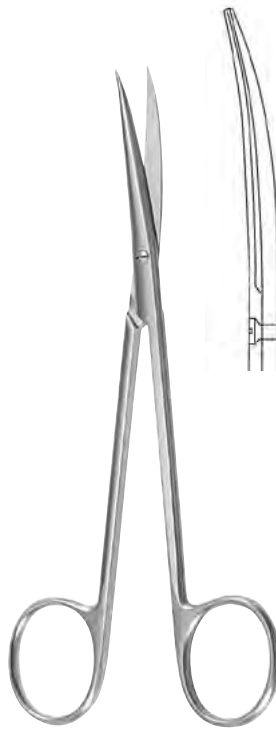

BROPHY-SULLIVAN

1114-1115 14,0 cm / 5 1/2"

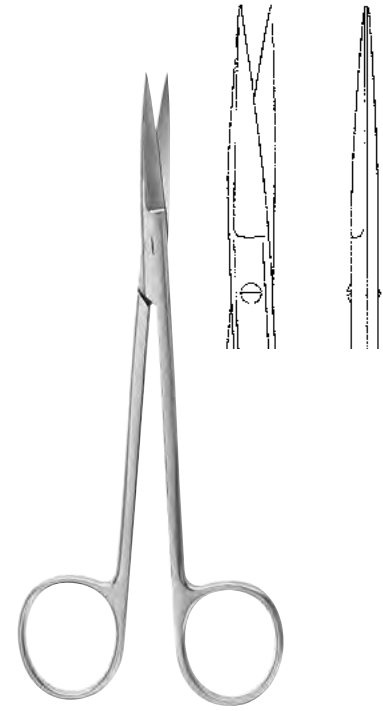

SANVENERO

1114-0814 14,0 cm / 5 1/2"

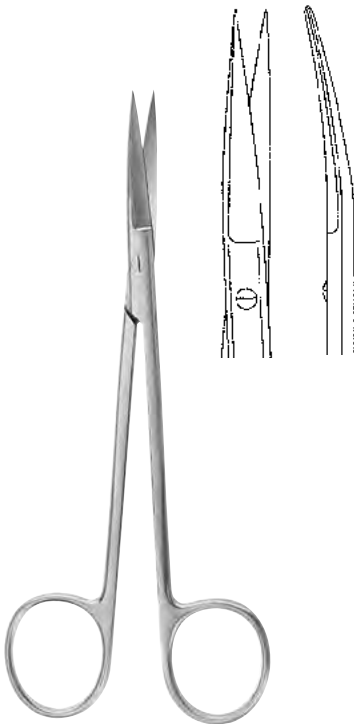

SANVENERO

1114-0914 14,0 cm / 5 1/2"

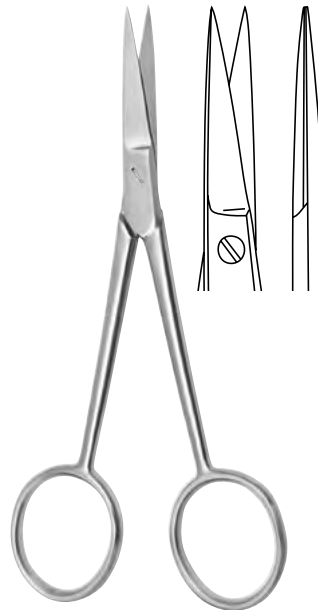

1114-1811 11,0 cm / 4 3/8"

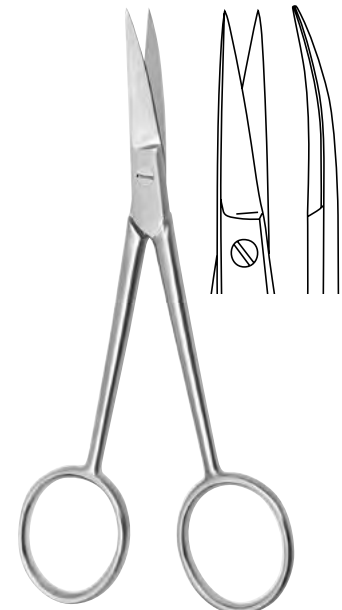

1114-4511 11,0 cm / 4 3/8"

Feine chirurgische Scheren
Delicate Surgical Scissors
Tijeras finas para cirugía
Forbici fine per chirurgia

012

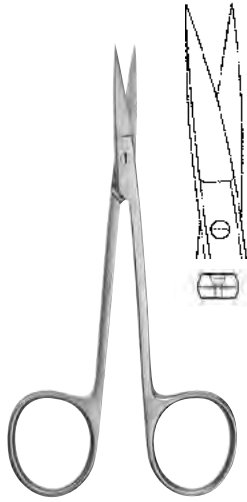

IRIS

1114-4009 9,0 cm / 3 1/2"
1114-4010 10,5 cm / 4 1/8"
1114-4011 11,5 cm / 4 1/2"



IRIS

1114-4109 9,0 cm / 3 1/2"
1114-4110 10,5 cm / 4 1/8"
1114-4111 11,5 cm / 4 1/2"



1114-3911 11,5 cm / 4 1/2"



1114-3811 11,5 cm / 4 1/2"

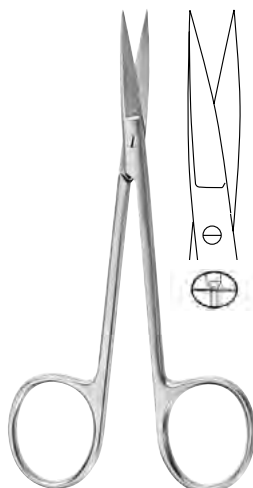

IRIS

1114-3609 9,0 cm / 3 1/2"
1114-3610 10,5 cm / 4 1/8"
1114-3611 11,5 cm / 4 1/2"

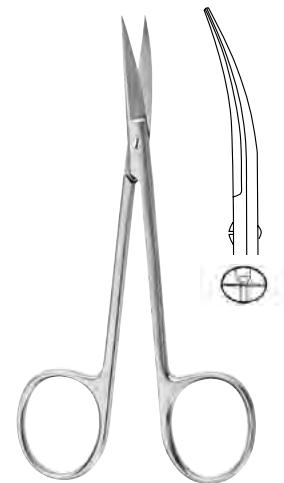

IRIS

1114-3709 9,0 cm / 3 1/2"
1114-3710 10,5 cm / 4 1/8"
1114-3711 11,5 cm / 4 1/2"



STEVENS
1114-3411 11,5 cm / 4 1/2"



STEVENS
1114-3511 11,5 cm / 4 1/2"



STEVENS
1114-3211 11,5 cm / 4 1/2"

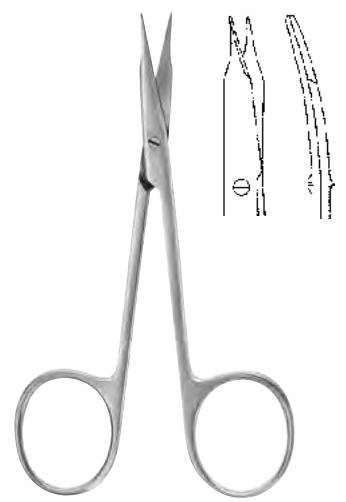

STEVENS
1114-3311 11,5 cm / 4 1/2"

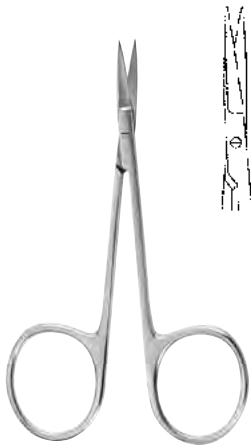

MOD. BONN
1114-4608 8,0 cm / 3 1/4"



MOD. BONN
1114-4708 8,0 cm, 3 1/4"

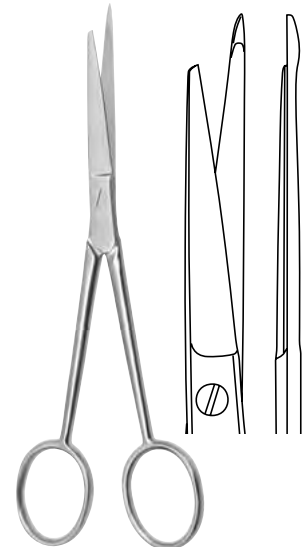

1115-3214 14,5 cm / 5 3/4"

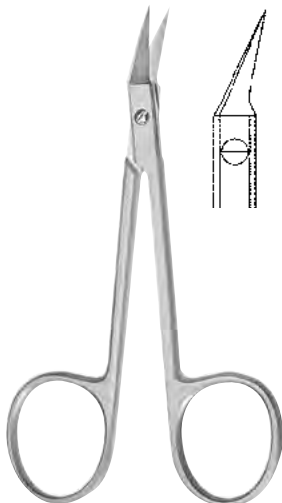

O'BRIAN
1114-3909 9,5 cm / 3 3/4"



STRABISMUS
1112-3611 11,5 cm / 4 1/2"



STRABISMUS
1112-3711 11,5 cm / 4 1/2"



WAGNER

1114-2612 12,0 cm / 4 3/4"



WAGNER

1114-2712 12,0 cm / 4 3/4"

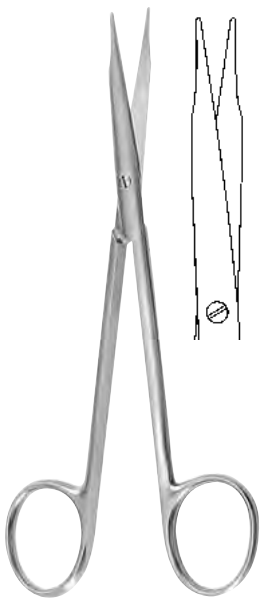

REYNOLDS

1112-4815 15,0 cm / 6"

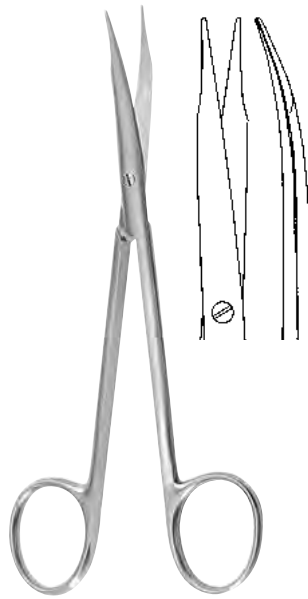

REYNOLDS

1112-4915 15,0 cm / 6"
1112-4918 17,5 cm / 7"

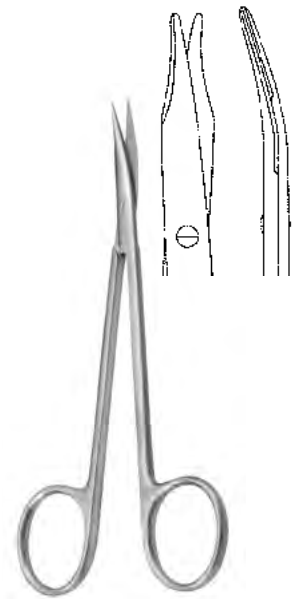

JAMESON

1112-4715 15,0 cm / 6"

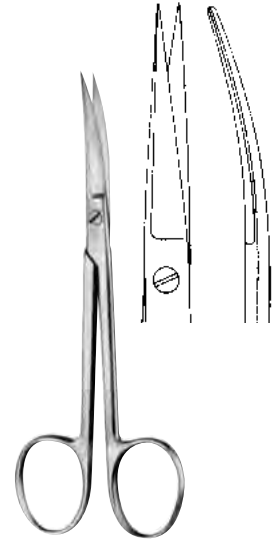
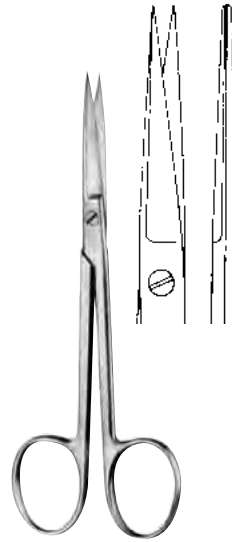
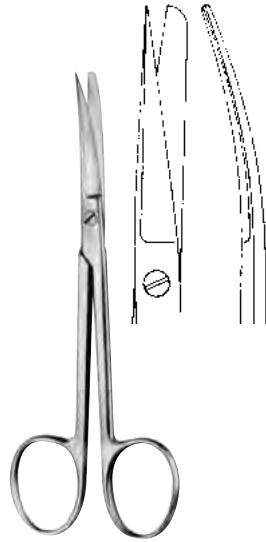
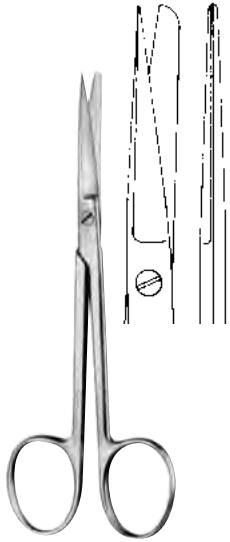

1114-2212 12,0 cm / 4³/₄"

1114-2312 12,0 cm / 4³/₄"

1114-2412 12,0 cm / 4³/₄"

1114-2512 12,0 cm / 4³/₄"

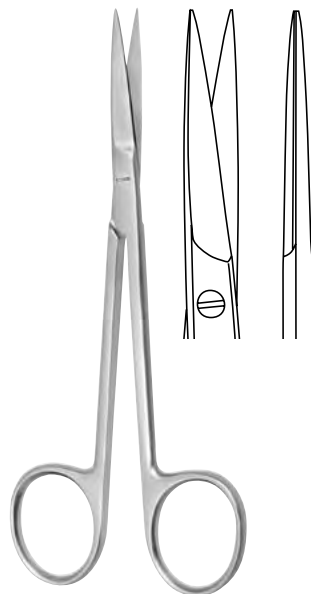

1110-0613 13,0 cm / 5¹/₈"

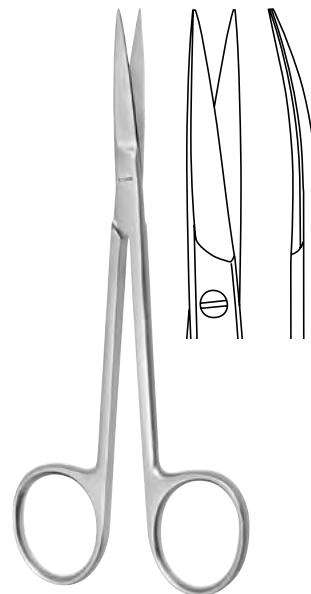

1110-0713 13,0 cm / 5¹/₈"

Gefäßscheren, Darmscheren, Lungenlappenscheren
Vascular Scissors, Enterotomy Scissors, Lobectomy Scissors
Tijeras vasculares, Tijeras enterótomos, Tijeras para lobectomia
Forbici vascolari, Forbici per enterotomia, Forbici per lobo polmonare

012

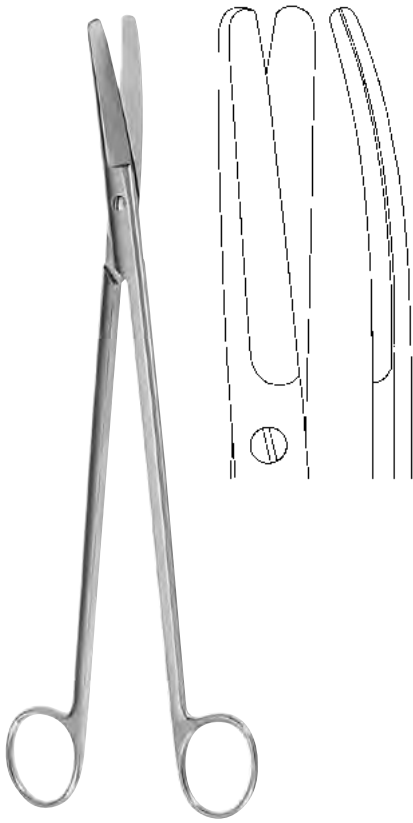

CRAFOORD
1111-3730 30,0 cm / 12"

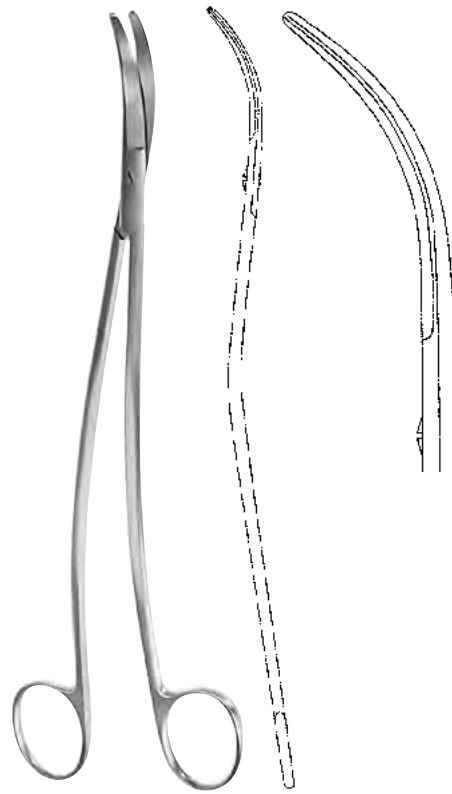

SATINSKY
1115-0124 24,5 cm / 9³/₄"

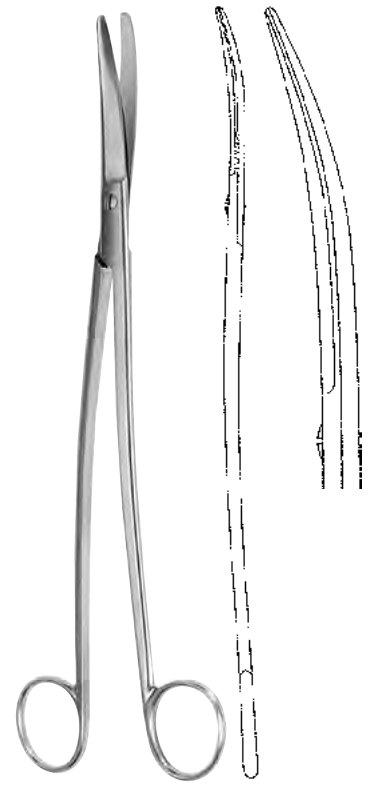

KLINGENBERG-LOTH
1115-0323 23,0 cm / 9"

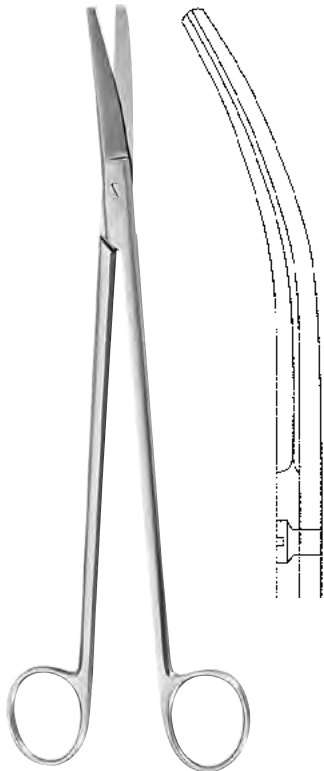

LLOYD-DAVIS
1111-8126 27,0 cm / 10⁵/₈"

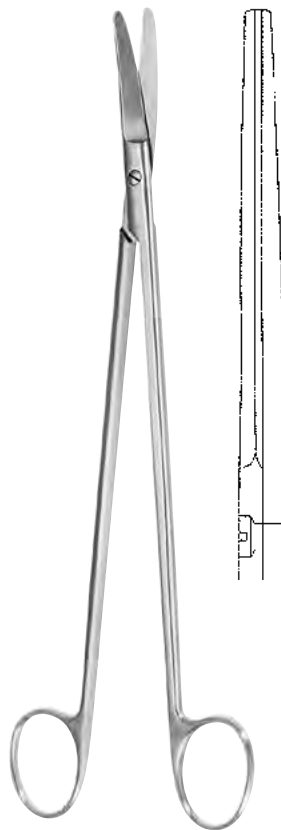

STELZNER
1111-8431 31,0 cm / 12¹/₄"

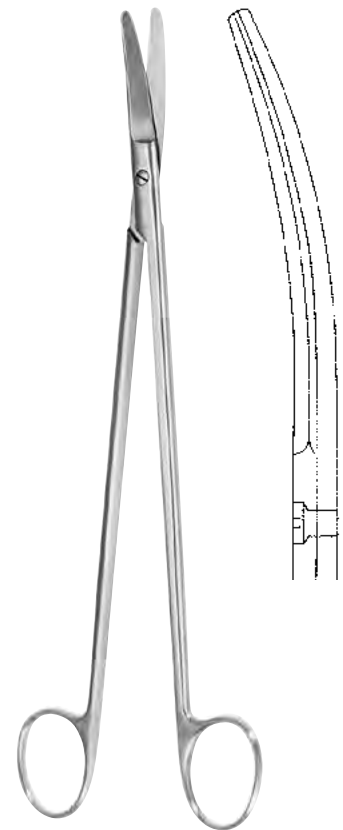

STELZNER
1111-8531 31,0 cm / 12¹/₄"

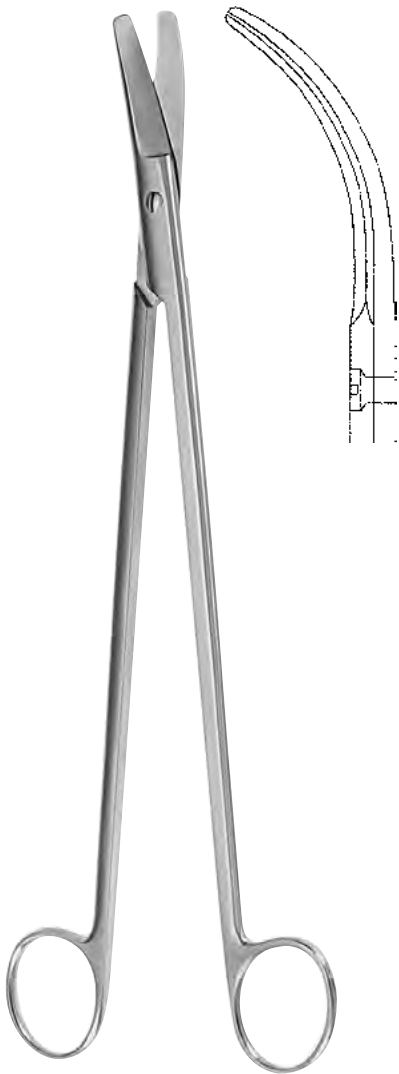
**RECTAL**

1111-8332 32,5 cm / 12³/₄"

**FINOCHIETTO**

1111-7927 27,0 cm / 10⁵/₈"

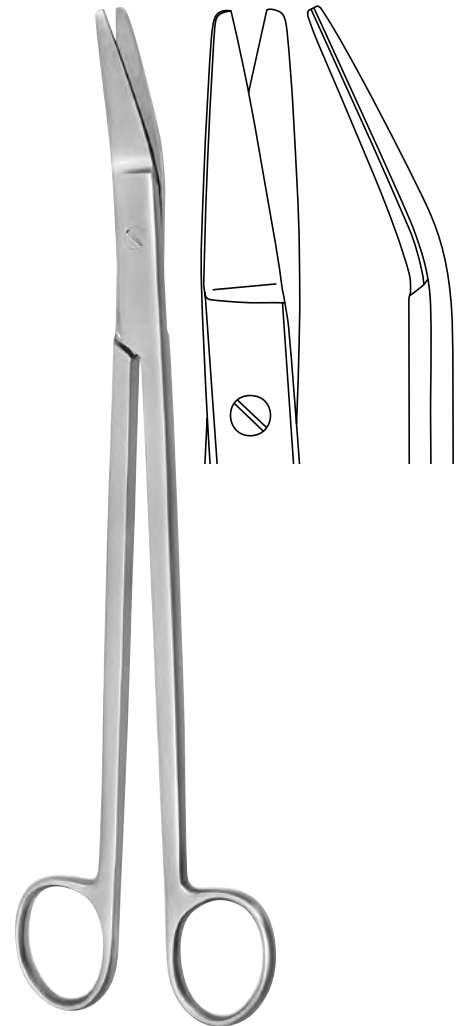
**RESANO**

1111-7524 25,0 cm / 9³/₄"



1115-8019

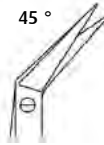

1115-8219



1115-8419

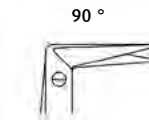

1115-8619



1115-8819

DIETRICH

1115-8019 - 1115-8819

19,0 cm / 7 1/2"



DIETRICH-HEGEMANN

1115-8919

19,0 cm / 7 1/2"

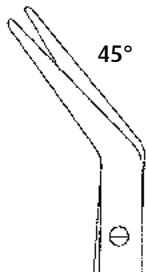
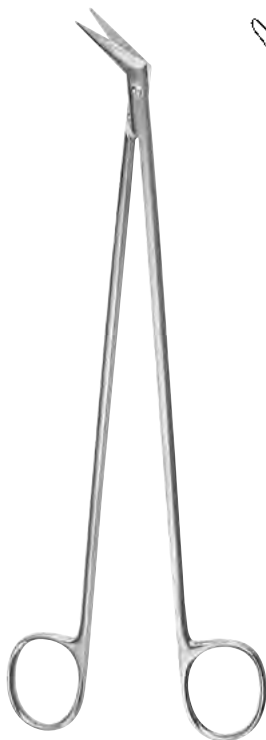

1115-4316

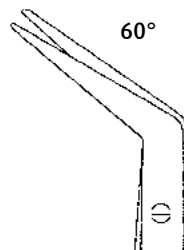

1115-4516

DE BAKEY

1115-4316 16,5 cm / 6 1/2"

1115-4516 16,0 cm / 6 1/4"

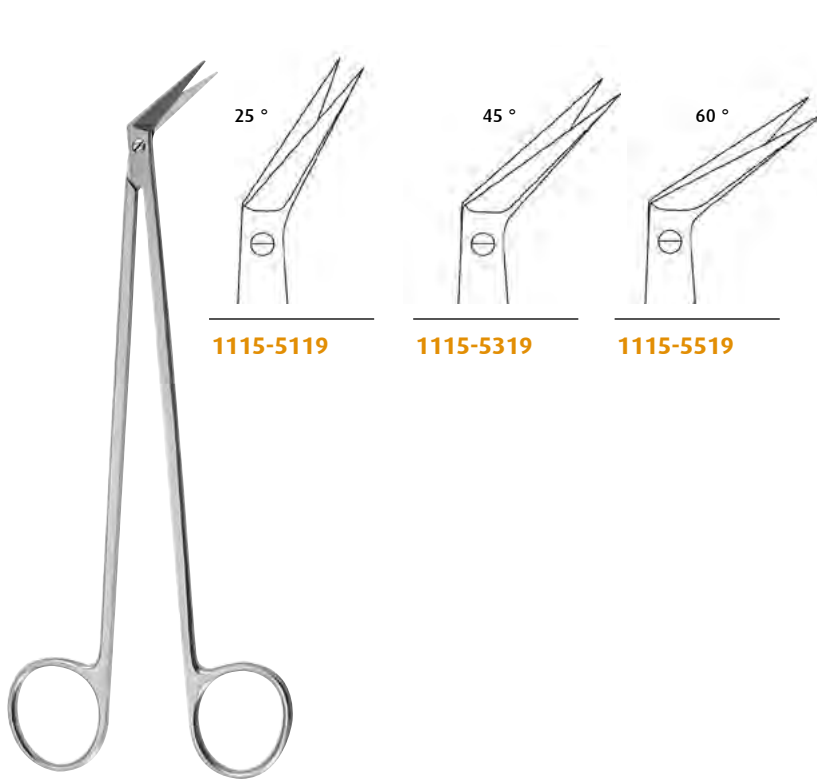

25 °

1115-5119

45 °

1115-5319

60 °

1115-5519

POTTS-SMITH

1115-5119 - 1115-5519 19,0 cm / 7 1/2"

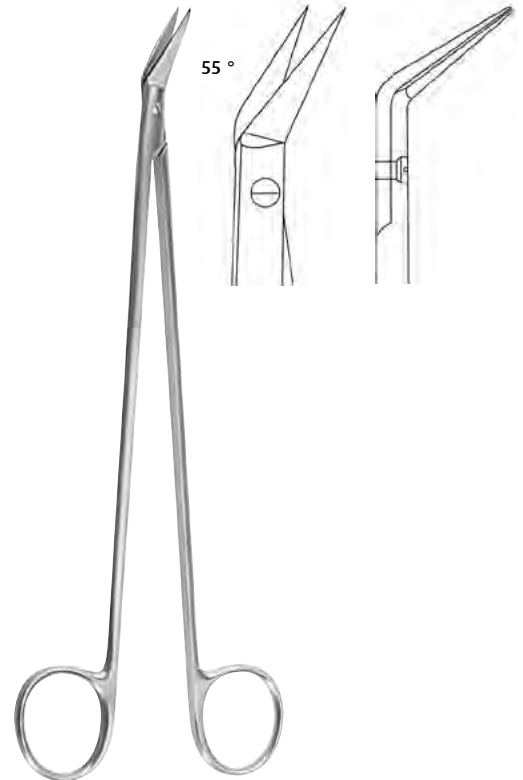

55 °

POTTS-SMITH

1115-6018 18,0 cm / 7"

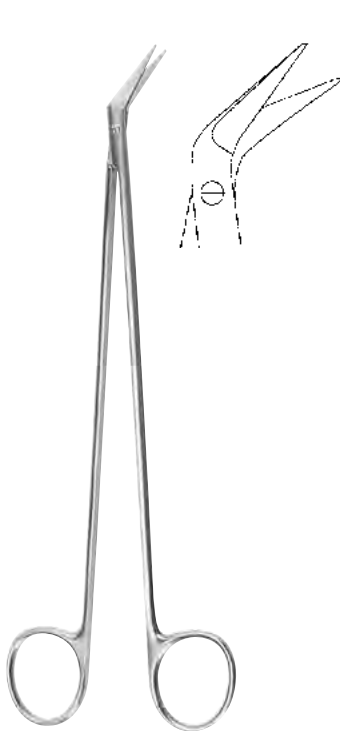

POTTS DE MARTEL

1115-5821 21,0 cm / 8 1/4"
1115-5824 24,0 cm / 9 1/2"

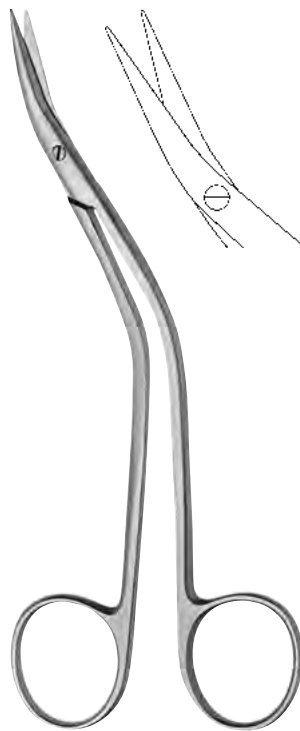

DE BAKEY

1115-2515 15,5 cm / 6"



DE BAKEY

1115-2516 15,5 cm / 6"

Gefäßscheren
 Vascular Scissors
 Tijeras vasculares
 Forbici vascolari



FAVALORO

1115-2915 15,5 cm / 6"

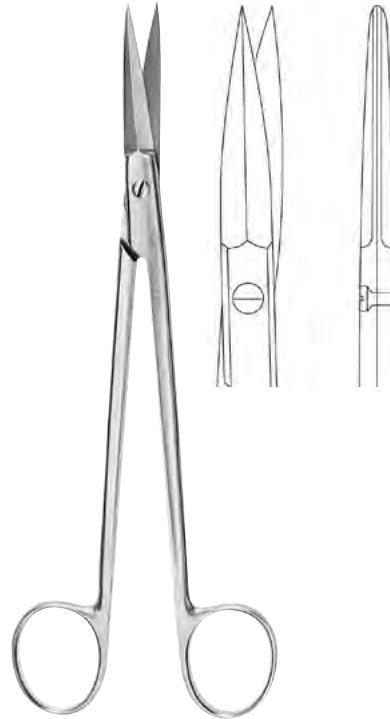

MC INDOE

1113-0019 19,0 cm / 7 1/2"



geknöpftes Blatt
 probe-pointed blade
 punta botonada
 lame bottonuta

1115-3111 11,5 cm / 4 1/2"

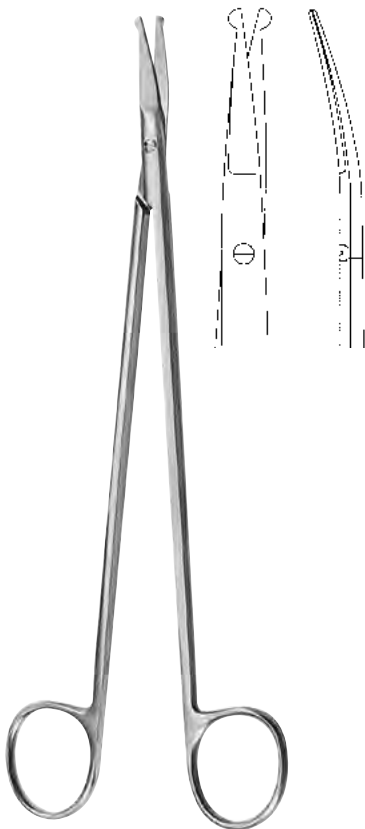

STRULLY

1115-0522 22,0 cm / 8 5/8"

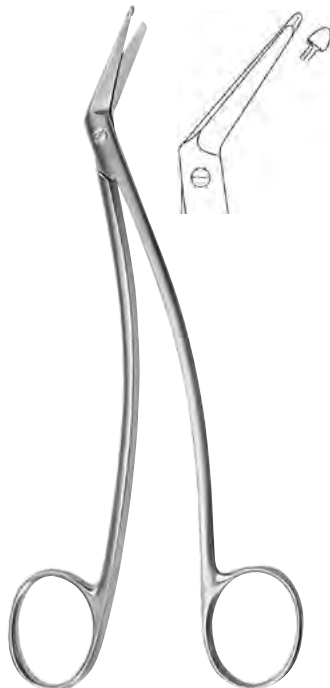

SCHMIEDEN-TAYLOR

1115-2317 17,0 cm / 6 3/4"

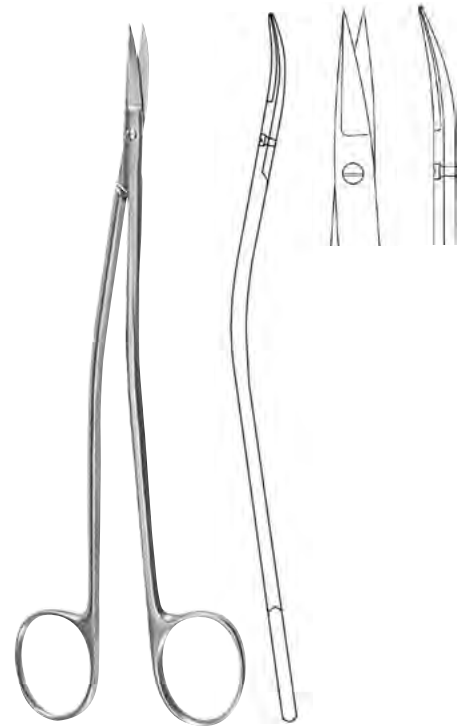

DANDY

1115-1117 17,0 cm / 6 3/4"



1112-5018

1112-5118

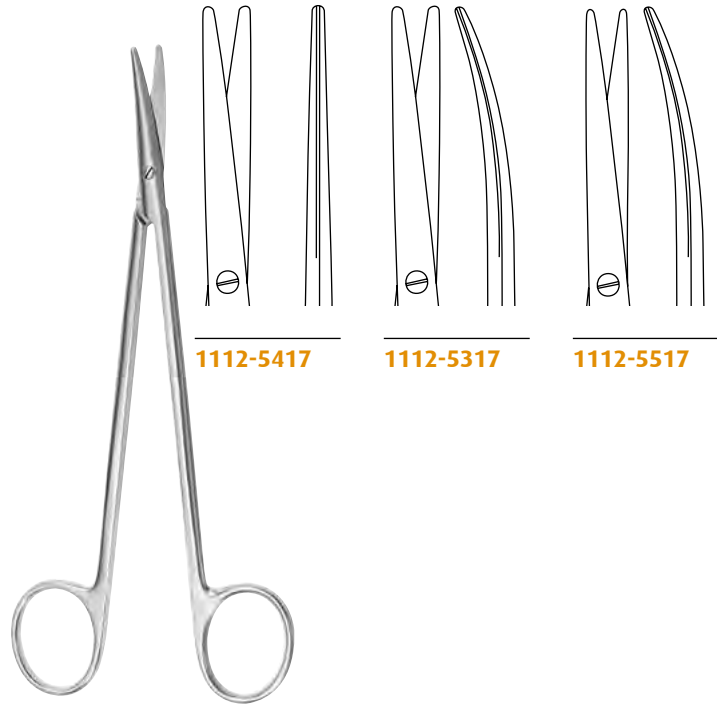

1112-5417

1112-5317

1112-5517

TOENNIS

1112-5018 - 1112-5118

18,0 cm / 7"

TOENNIS-ADSON

1112-5417 - 1112-5517

17,5 cm / 7"



OLIVECRONA

1113-3823

23,0 cm / 9"

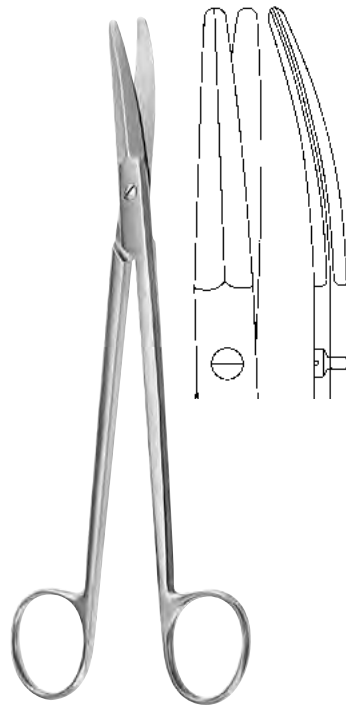

BOETTCHER

1113-0118

18,0 cm / 7"

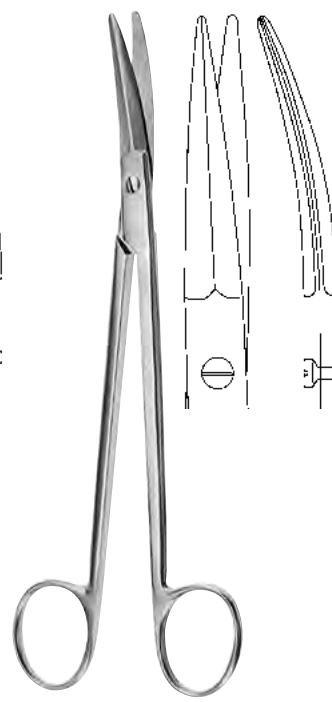

PRINCE

1113-0317

17,5 cm / 7"

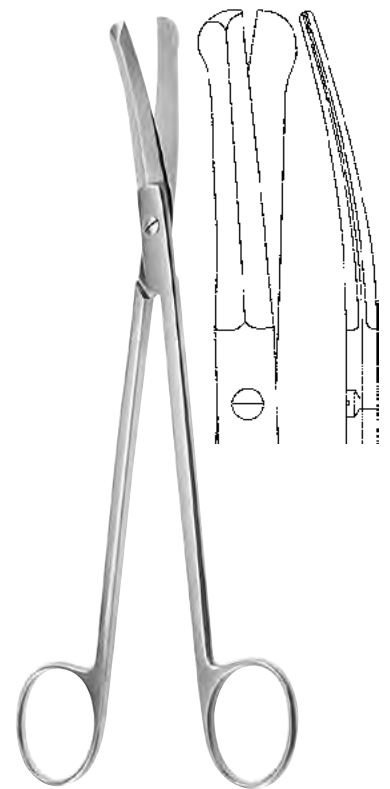

GOOD

1113-0919

19,0 cm / 7 1/2"

Tonsillenscheren, Nasenscheren
Tonsil Scissors, Nasal Scissors
Tijeras para amígdalas, Tijeras para el tabique nasal
Forbici per tonsille, Forbici per il setto nasale

012



HEYMANN

1113-3518 18,0 cm / 7"

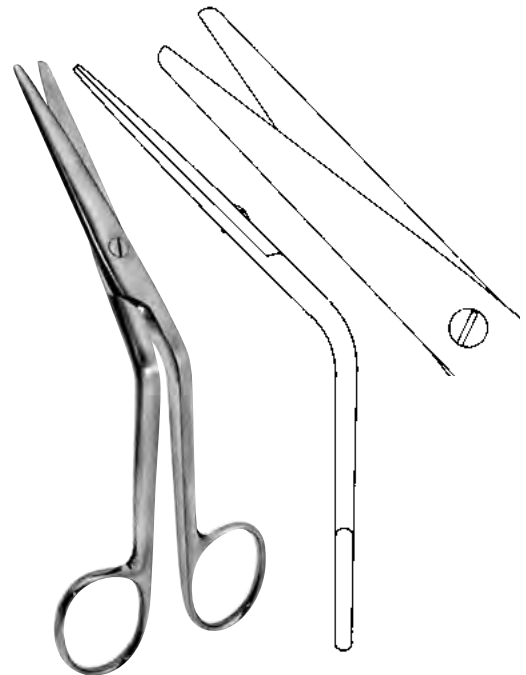

COTTLE

1113-3116 16,0 cm / 6 1/4"

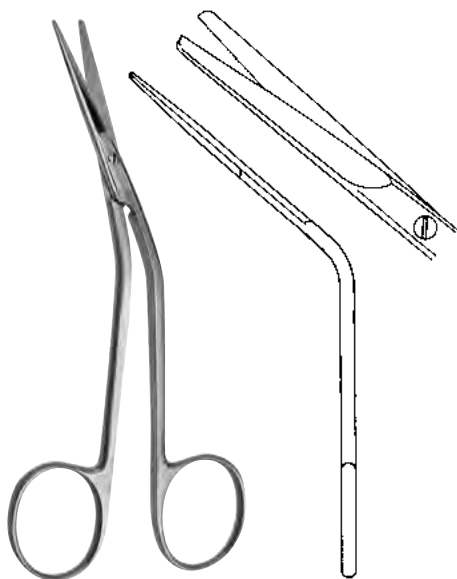

FOMON

1113-2915 15,0 cm / 6"

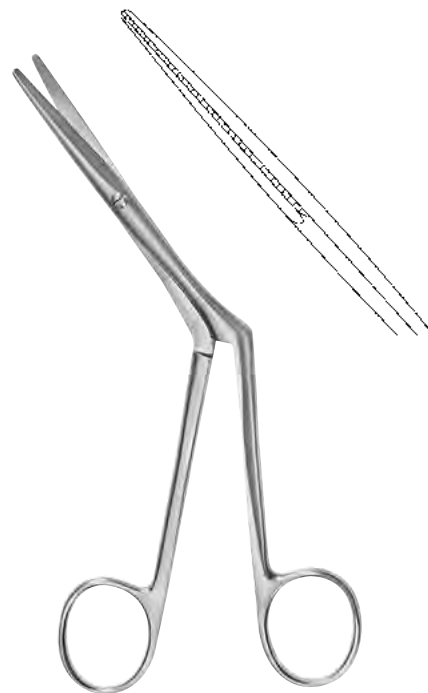

KIRSTEIN

1113-3718 18,0 cm / 7"



1114-0016

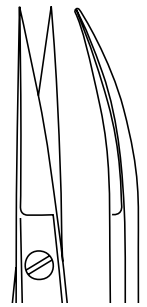

1114-0116

KELLY

1114-0016 - 1114-0116 16,0 cm / 6 1/4"



1113-0517

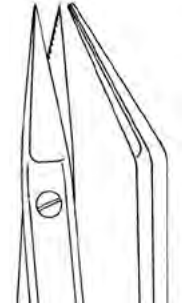

1113-0717

DEAN

1113-0517 - 1113-0717 17,0 cm / 6 3/4"

1 Schneide gezahnt
1 toothed blade
1 hoja dentada
1 lame dentata

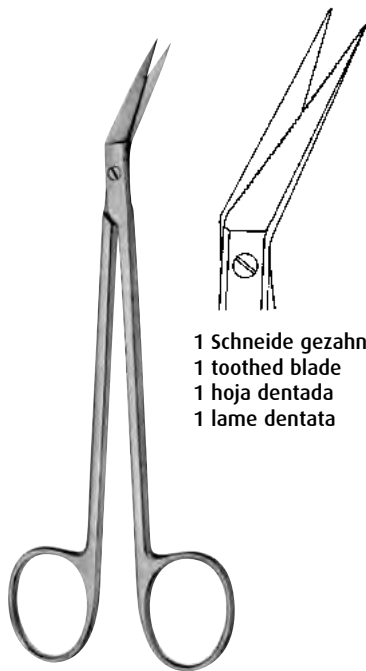

1 Schneide gezahnt
1 toothed blade
1 hoja dentada
1 lame dentata

LOCKLIN

1115-1916 16,0 cm / 6 1/4"

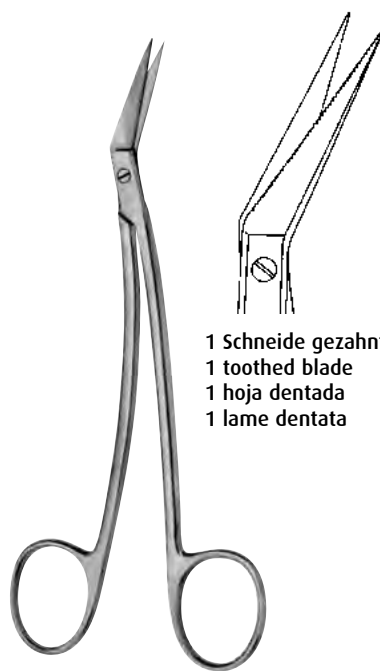

1 Schneide gezahnt
1 toothed blade
1 hoja dentada
1 lame dentata

LOCKLIN

1115-2116 16,0 cm / 6 1/4"

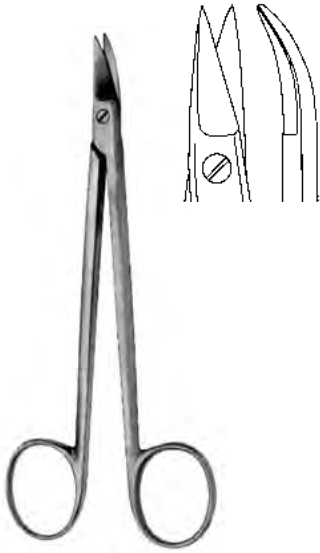

QUINBY

1114-0713 12,5 cm / 5"

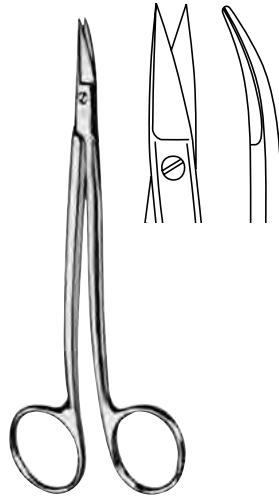

NEUMANN

1114-1212 12,5 cm / 5"

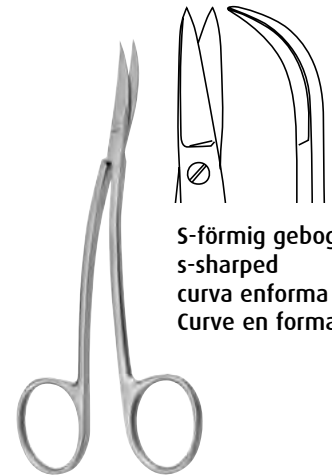

S-förmig gebogen
 s-sharped
 curva en forma S
 Curve en forma S

LA GRANGE

1114-1311 11,5 cm / 4 1/2"

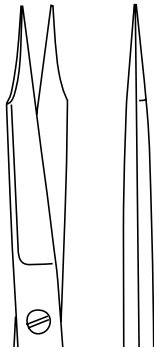

1114-1413



1114-1513



GOLDMANN-FOX

1114-1413- 1114-1513 13,0 cm / 5 1/8"

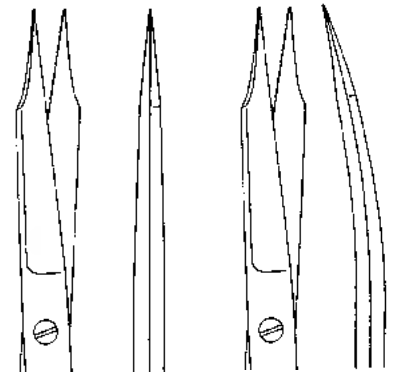

1114-1613

1114-1713

1 Schneide gezahnt
 1 toothed blade
 1 hoja dentada
 1 lame dentata



GOLDMANN-FOX

1114-1613 - 1114-1713 13,0 cm / 5 1/8"

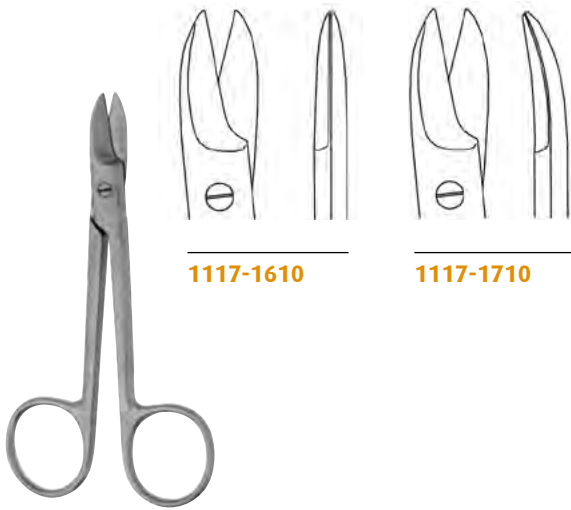

1117-1610

1117-1710

BEEBEE

1117-1610 - 1117-1710

10,5 cm / 4¹/₄"

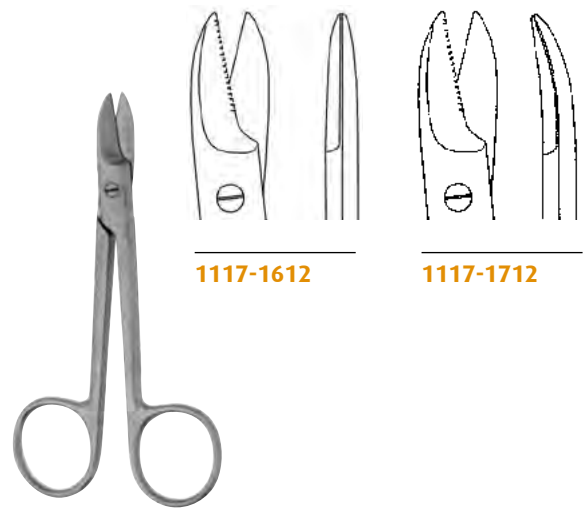

1117-1612

1117-1712

BEEBEE

1117-1612 - 1117-1712

10,5 cm / 4¹/₄"

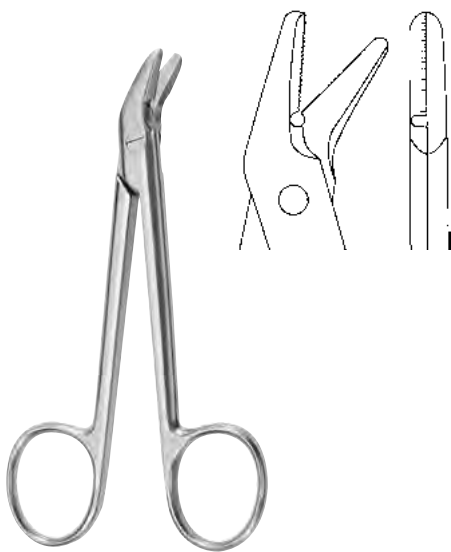

UNIVERSAL

1117-2112 12,0 cm / 4³/₄"



1111-5421 21,0 cm / 8¹/₄"



1111-5021 21,0 cm / 8¹/₄"



1111-5221 21,0 cm / 8¹/₄"



SPENCER

- 1117-0009** 9,0 cm / 3 1/2"
- 1117-0011** 10,5 cm / 4 1/4"
- 1117-0013** 13,0 cm / 5 1/8"



NORTHBENT

- 1117-0309** 9,0 cm / 3 1/2"
- 1117-0513** 12,5 cm / 5"



LITTAUER

- 1117-0614** 14,0 cm / 5 1/2"



BUCK

- 1117-0814** 14,5 cm / 5 3/4"
- 1117-0818** 18,0 cm / 7"

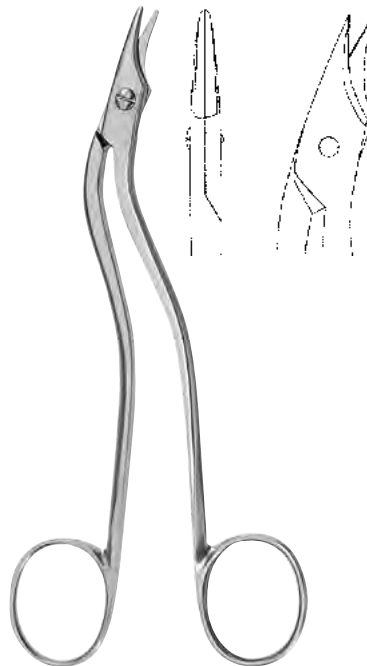

HEATH

- 1117-1115** 16,0 cm / 6 1/4"



EISELSBERG

- 1117-1012** 12,0 cm / 4 3/4"

Chirurgische Scheren mit Hartmetallschneiden
Surgical Scissors with tungsten carbide edges
Tijeras para cirugía con filos de carburo tungsteno
Forbici per chirurgia con lame in carburo di tungsteno

012

- lange Lebensdauer
 - hohe Wirtschaftlichkeit
 - hervorragende Schnitthaltigkeit
 - glatter weicher Schnitt
 - durchgehend gehärtet
 - vergoldete Ringe zur schnellen Identifikation
-

- long lasting performance
 - economical
 - excellent cutting action
 - smooth cutting
 - fully tempered
 - goldplated rings for easy identification
-

- larga duración
 - gran economía
 - corte de máxima agudeza
 - suave filo
 - completamente templado
 - anillos dorados para su identificación
-

- prestazioni di lunga durata
- risparmi sul costo
- eccellente accuratezza del taglio
- taglio liscio
- completamente temperato
- anelli bagnati in oro permettono una piú semplice identificazione





STANDARD

1120-0014 14,5 cm / 5³/₄"



STANDARD

1120-0114 14,5 cm / 5³/₄"



STANDARD

1120-0214 14,5 cm / 5³/₄"



STANDARD

1120-0314 14,5 cm / 5³/₄"

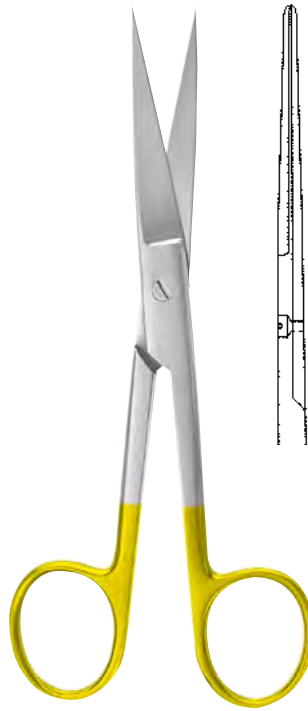

STANDARD

1120-0414 14,5 cm / 5³/₄"



STANDARD

1120-0514 14,5 cm / 5³/₄"

Chirurgische Scheren mit Hartmetallschneiden
Surgical Scissors with tungsten carbide edges
Tijeras para cirugía con filos de carburo tungsteno
Forbici per chirurgia con lame in carburo di tungsteno

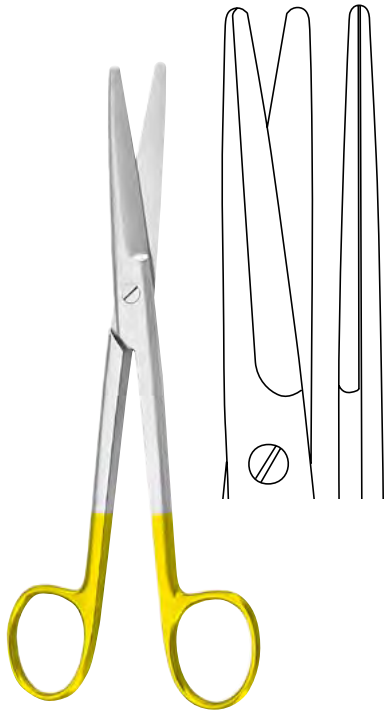

MAYO

- 1121-6014** 14,5 cm / 5³/₄"
- 1121-6017** 17,0 cm / 6³/₄"
- 1121-6023** 23,0 cm / 9"

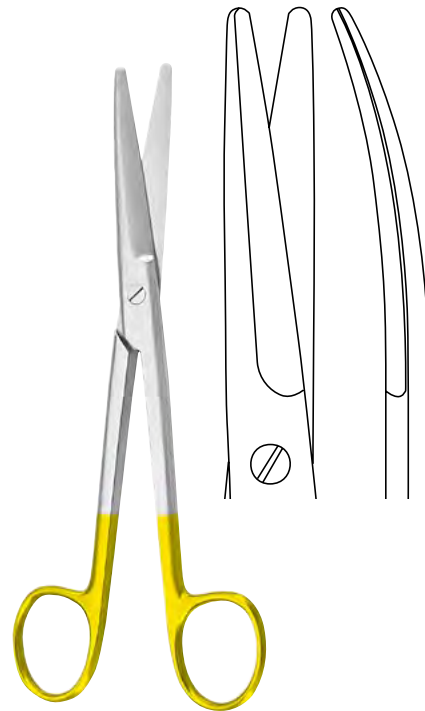

MAYO

- 1121-6114** 14,5 cm / 5³/₄"
- 1121-6117** 17,0 cm / 6³/₄"
- 1121-6123** 23,0 cm / 9"

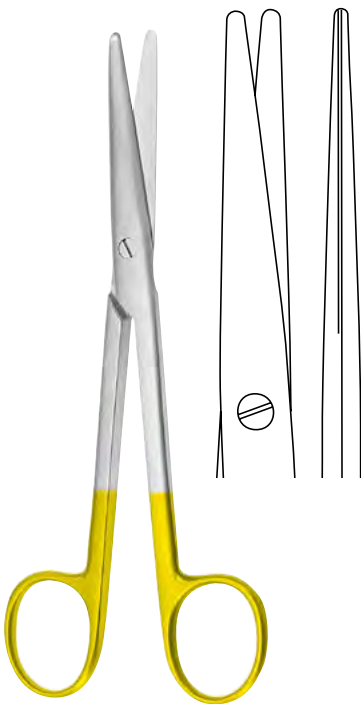

MAYO-STILLE

- 1121-7015** 15,0 cm / 6"
- 1121-7017** 17,0 cm / 6³/₄"

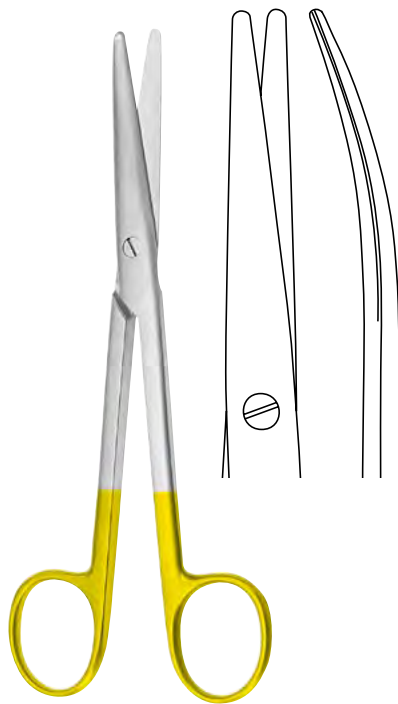

MAYO-STILLE

- 1121-7115** 15,0 cm / 6"
- 1121-7117** 17,0 cm / 6³/₄"



1122-3016

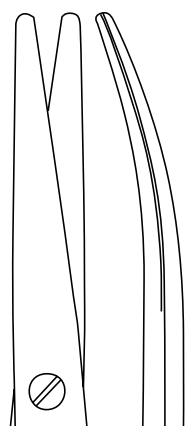

1122-3116

MAYO-LEXER

- 1122-3016 - 1122-3116** 16,0 cm / 6¹/₄"



LEXER

1122-3216 16,0 cm / 6 1/4"
1122-3021 21,0 cm / 8 1/4"

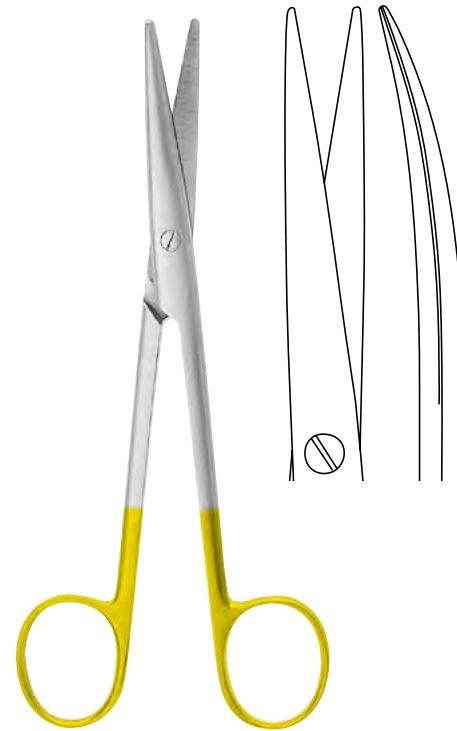

LEXER

1122-3316 16,0 cm / 6 1/4"
1122-3121 21,0 cm / 8 1/4"



1122-0011

1122-0111

METZENBAUM

1122-0011 - 1122-0111 11,5 cm / 4 1/2"

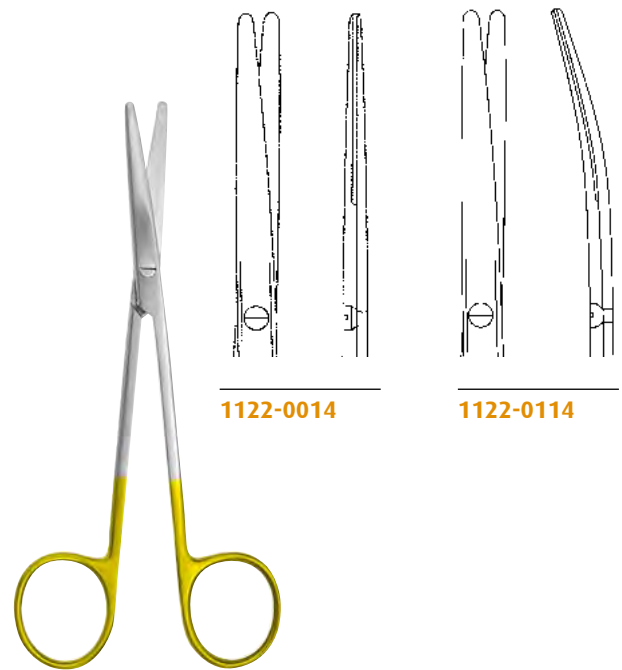

1122-0014

1122-0114

METZENBAUM

1122-0014 - 1122-0114 14,5 cm / 5 1/2"

Präparierscheren mit Hartmetallschneiden
Dissecting Scissors with tungsten carbide edges
Tijeras para disección con filos de carburo tungsteno
Forbici per dissezione con lame in carburo di tungsteno

012

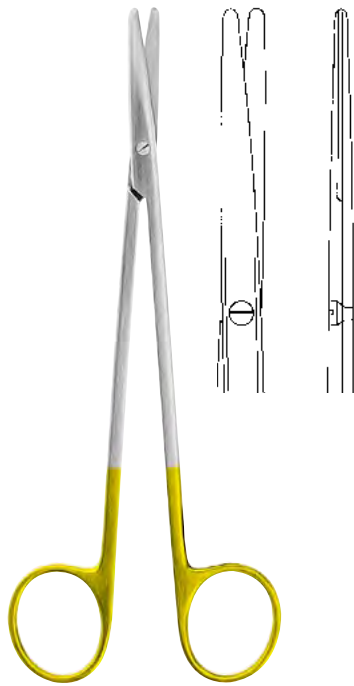

METZENBAUM

1122-0018	18,0 cm / 7"
1122-0020	20,0 cm / 8"
1122-0023	23,0 cm / 9"
1122-0025	25,0 cm / 10"
1122-0028	28,0 cm / 11"
1122-0030	30,0 cm / 12"

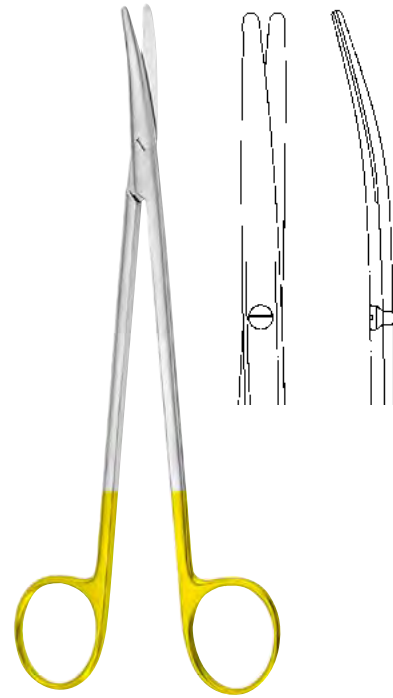

METZENBAUM

1122-0118	18,0 cm / 7"
1122-0120	20,0 cm / 8"
1122-0123	23,0 cm / 9"
1122-0125	25,0 cm / 10"
1122-0128	28,0 cm / 11"
1122-0130	30,0 cm / 12"

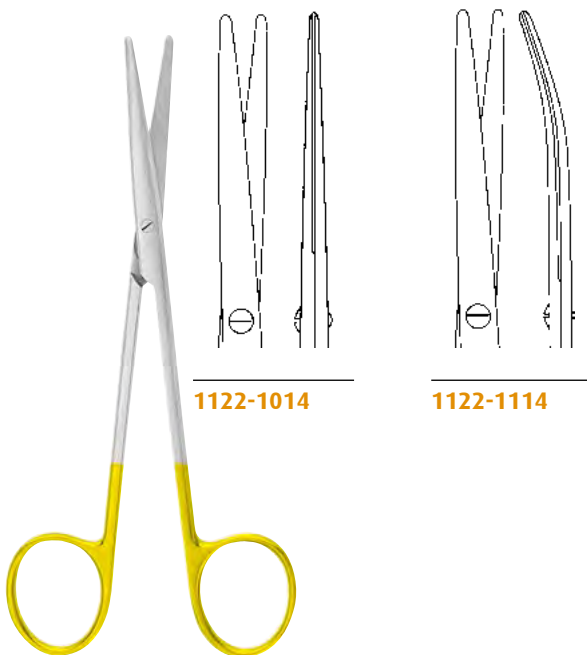

1122-1014

1122-1114

METZENBAUM-FINO

1122-1014 - 1122-1114	14,5 cm / 5 1/2"
------------------------------	------------------

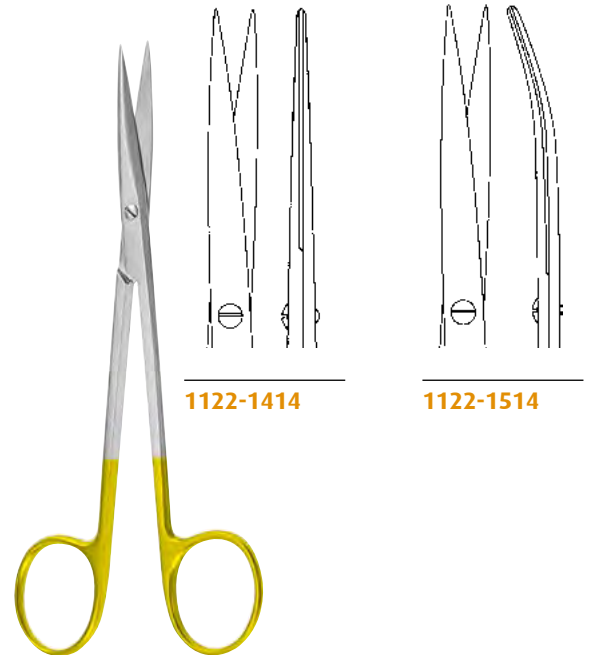

1122-1414

1122-1514

METZENBAUM-FINO

1122-1414 - 1122-1514	14,5 cm / 5 1/2"
------------------------------	------------------

Präparierscheren mit Hartmetallschneiden
Dissecting Scissors with tungsten carbide edges
Tijeras para disección con filos de carburo tungsteno
Forbici per dissezione con lame in carburo di tungsteno

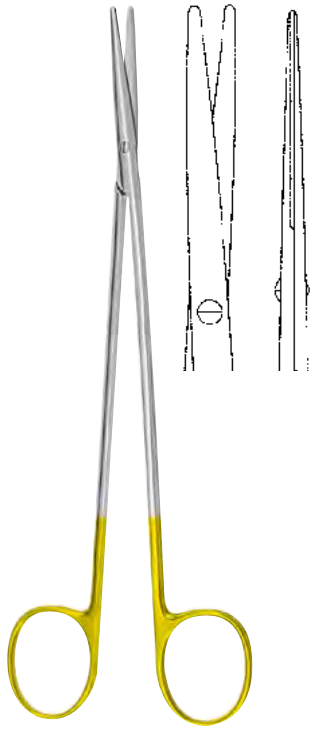
**METZENBAUM-FINO**

1122-1018	18,0 cm / 7"
1122-1020	20,0 cm / 8"
1122-1023	23,0 cm / 9"
1122-1025	25,0 cm / 10"
1122-1028	28,0 cm / 11"

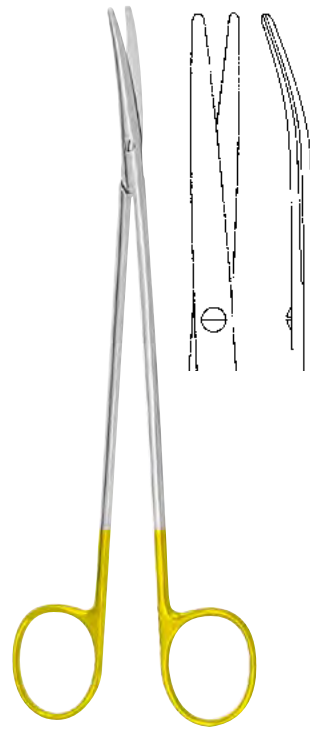
**METZENBAUM-FINO**

1122-1118	18,0 cm / 7"
1122-1120	20,0 cm / 8"
1122-1123	23,0 cm / 9"
1122-1125	25,0 cm / 10"
1122-1128	28,0 cm / 11"

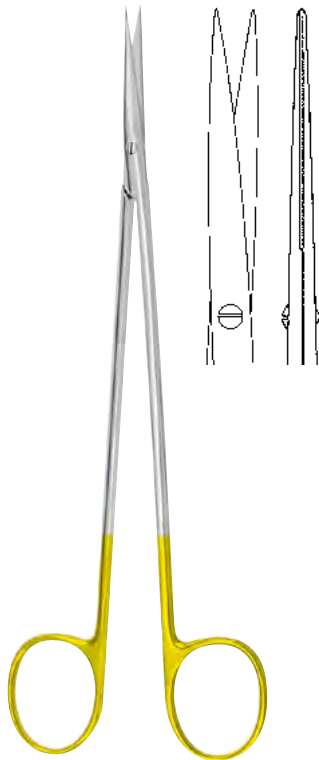
**METZENBAUM-FINO**

1122-1418	18,0 cm / 7"
1122-1420	20,0 cm / 8"
1122-1423	23,0 cm / 9"

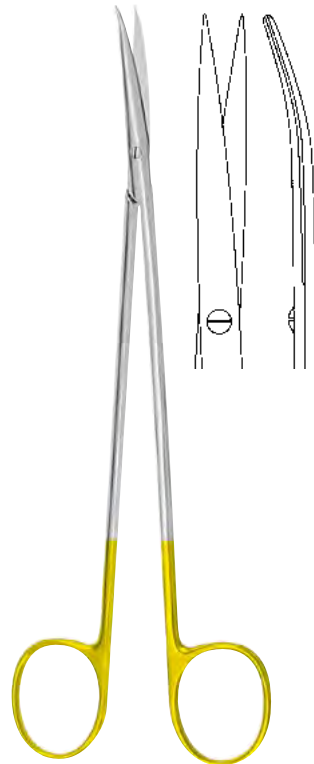
**METZENBAUM-FINO**

1122-1518	18,0 cm / 7"
1122-1520	20,0 cm / 8"
1122-1523	23,0 cm / 9"

Präparierscheren mit Hartmetallschneiden
Dissecting Scissors with tungsten carbide edges
Tijeras para disección con filos de carburo tungsteno
Forbici per dissezione con lame in carburo di tungsteno

012

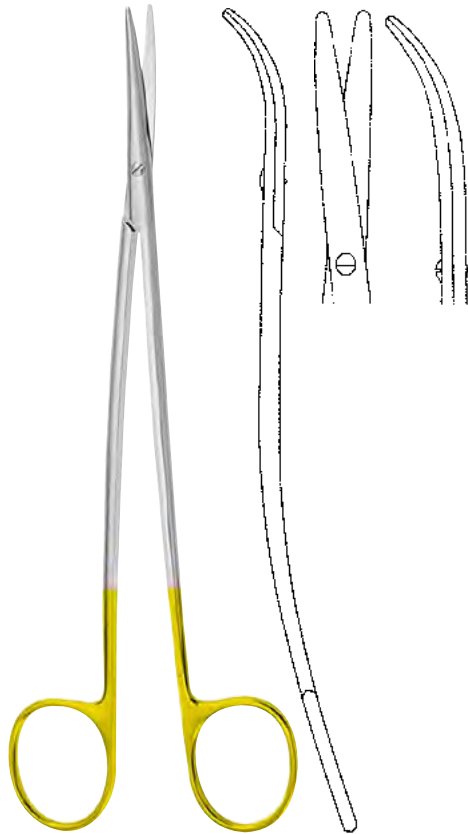

METZENBAUM-FINO S

1122-2118	18,0 cm / 7"
1122-2120	20,0 cm / 8"
1122-2123	23,0 cm / 9"

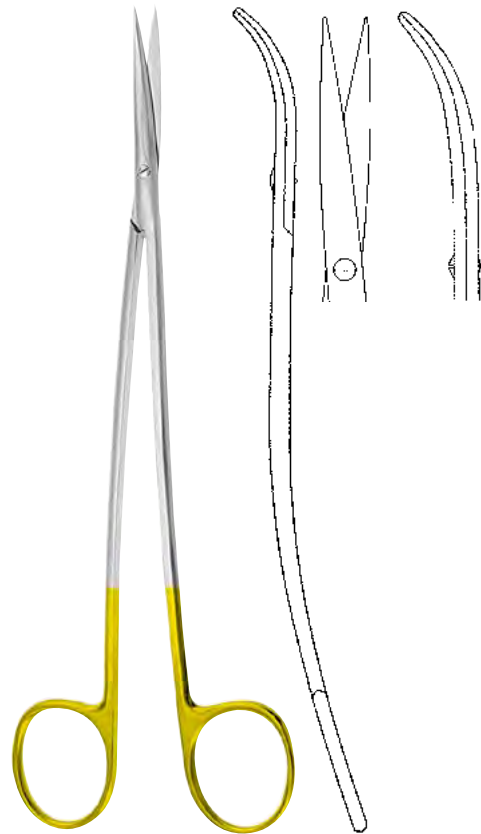

METZENBAUM-FINO S

1122-2518	18,0 cm / 7"
1122-2520	20,0 cm / 8"
1122-2523	23,0 cm / 9"

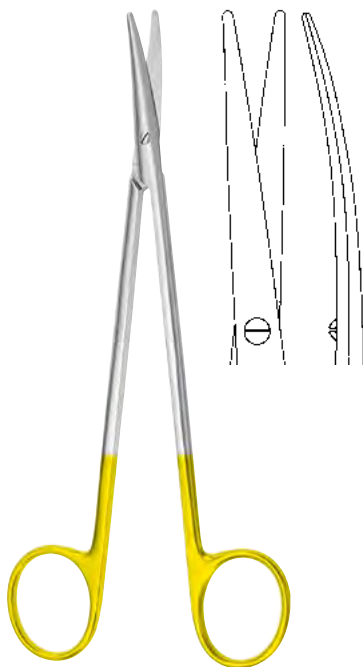

TOENNIS-ADSON

1122-5317	17,5 cm / 7"
-----------	--------------

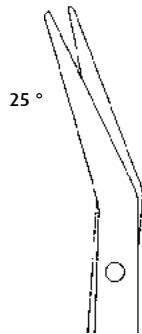

25 °

1125-5119

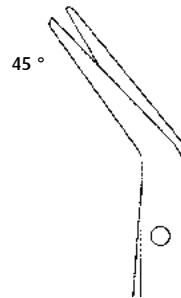

45 °

1125-5319

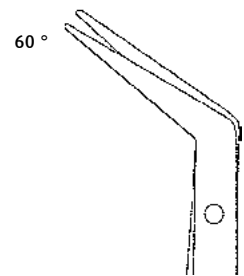

60 °

1125-5519

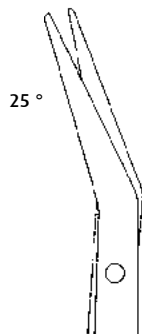

25 °

1125-4123

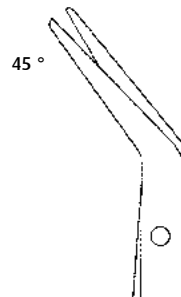

45 °

1125-4323

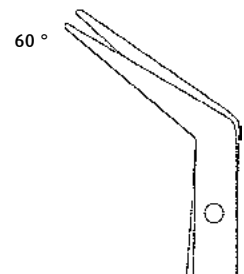

60 °

1125-4523

DE BAKEY

1125-5119 - 1125-5519

18,0 cm / 7"

1125-4123 - 1125-4523

23,0 cm / 9"

Gynäkologische Scheren mit Hartmetallschneiden
Gynecology Scissors with tungsten carbide edges
Tijeras para ginecología con filos de carburo tungsteno
Forbici per ginecologia con lame in carburo di tungsteno

012

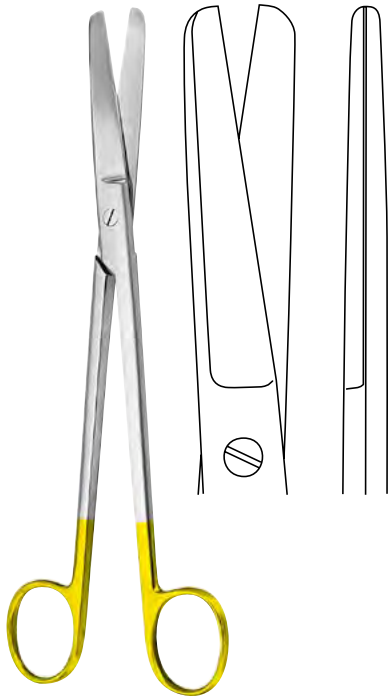

SIMS

1121-2020 20,0 cm / 8"
1121-2023 23,0 cm / 9"

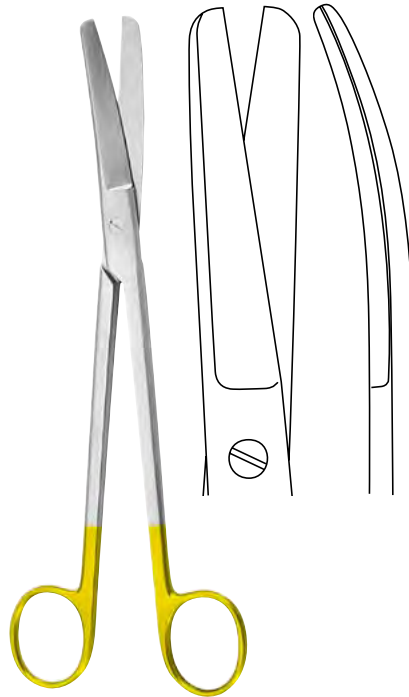

SIMS

1121-2120 20,0 cm / 8"
1121-2123 23,0 cm / 9"

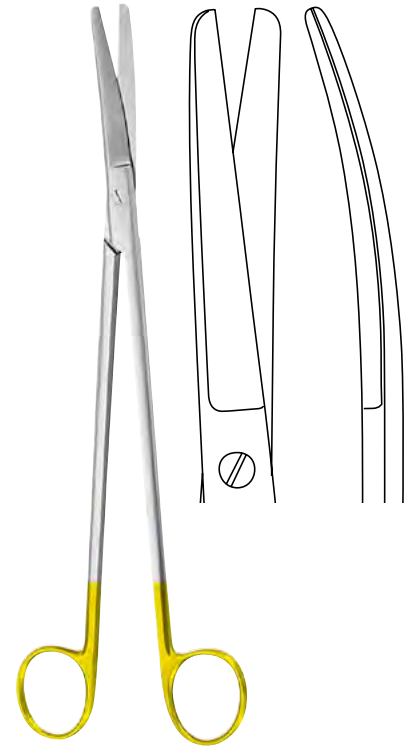

WERTHEIM

1121-6723 22,5 cm / 8³/₄"

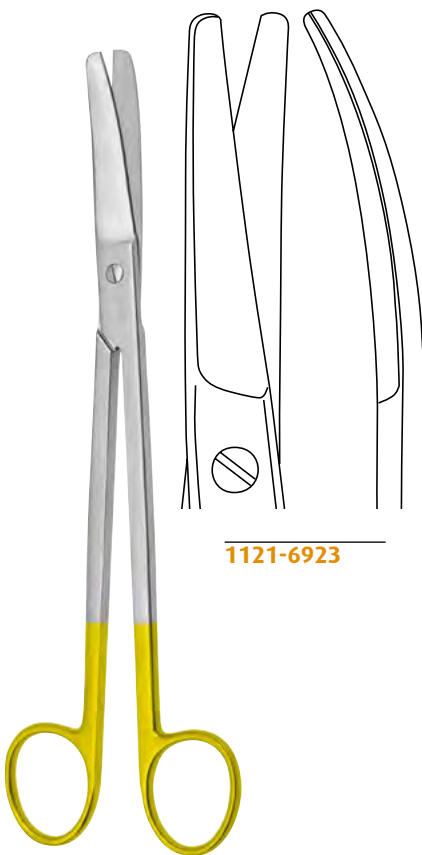

1121-6923

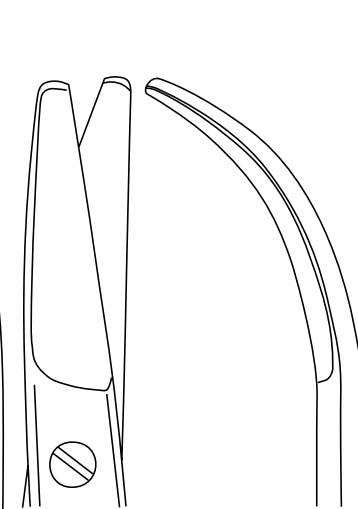

1121-6722

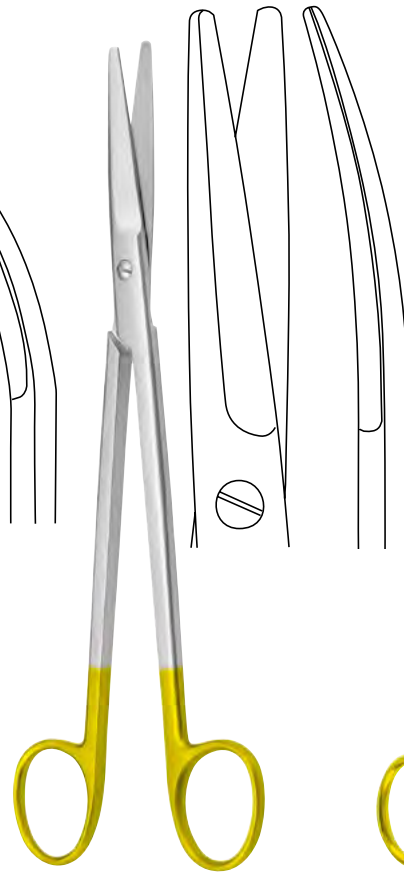

MAYO-HARRINGTON

1121-6728 28,0 cm / 11"



gezahnt
toothed
dentada
dentate

PARAMETRIUM

1121-6923 22,5 cm / 8³/₄"
1121-6722 23,0 cm / 9"

1121-4120 19,5 cm / 7³/₄"

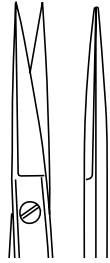

IRIS
 1124-3611 11,5 cm / 4 1/2"

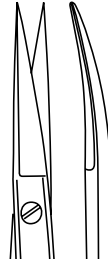

IRIS
 1124-3711 11,5 cm / 4 1/2"

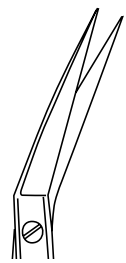
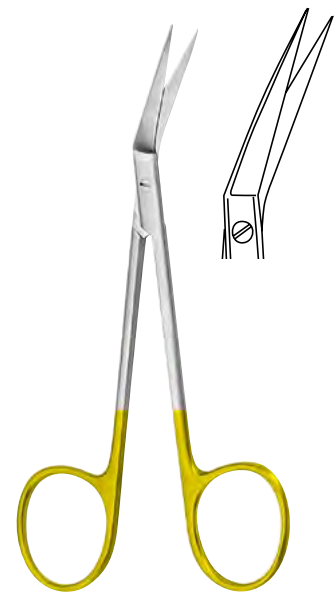

IRIS
 1124-3811 11,5 cm / 4 1/2"

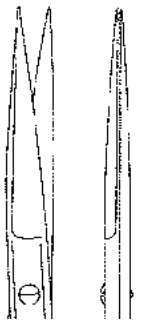

1124-0414



1124-0514

JOSEPH
 1124-0414 - 1124-0514 14,0 cm, 5 1/2"

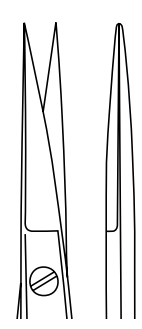
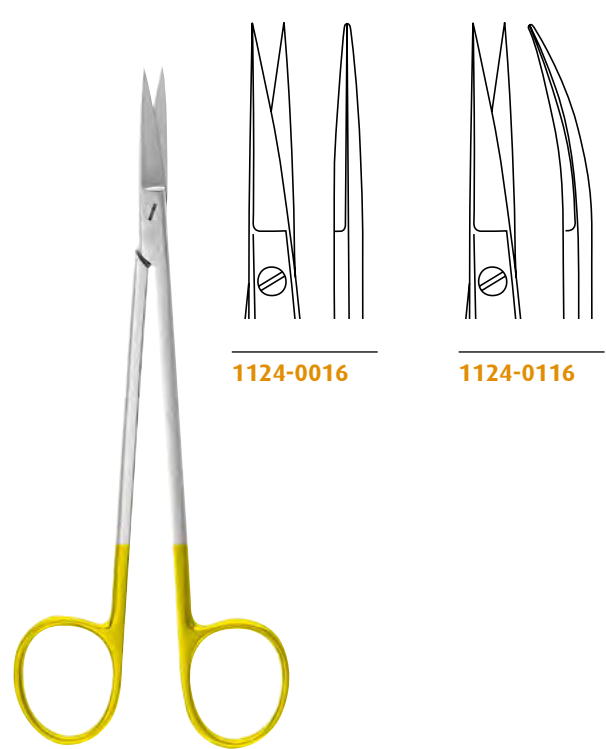

1124-0016

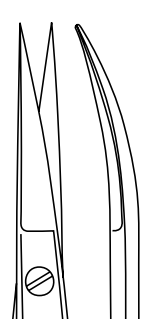

1124-0116

KELLY
 1124-0016 - 1124-0116 16,0 cm / 6 1/4"

Scheren mit Hartmetallschneiden
 Scissors with tungsten carbide edges
 Tijeras con filos de carburo tungsteno
 Forbici con lame in carburo di tungsteno

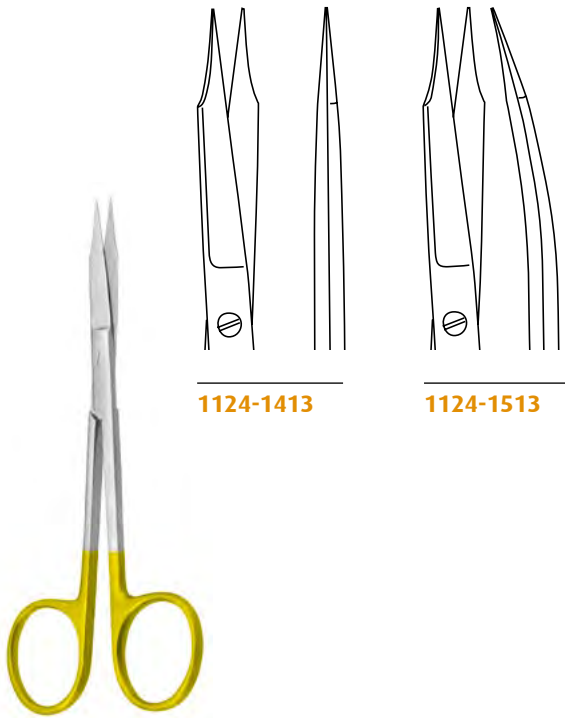

1124-1413

1124-1513

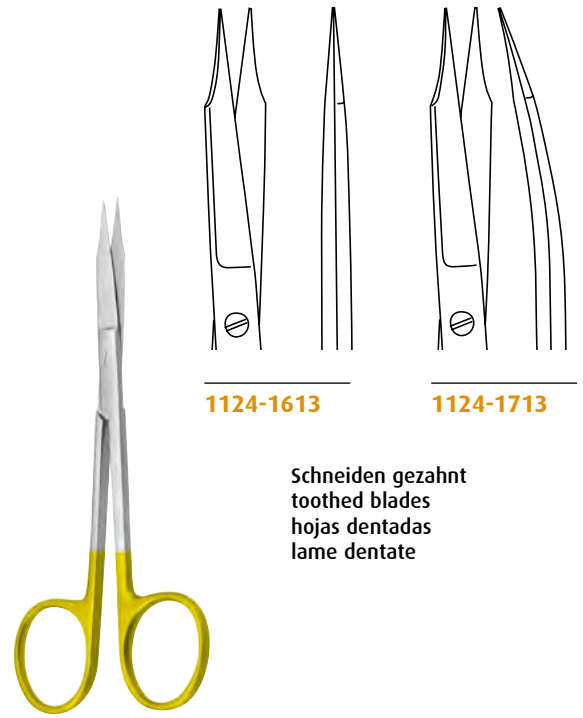

1124-1613

1124-1713

Schneiden gezahnt
 toothed blades
 hojas dentadas
 lame dentate

GOLDMANN-FOX

1124-1413 - 1124-1513

13,0 cm / 5 1/8"

GOLDMANN-FOX

1124-1613 - 1124-1713

13,0 cm / 5 1/8"

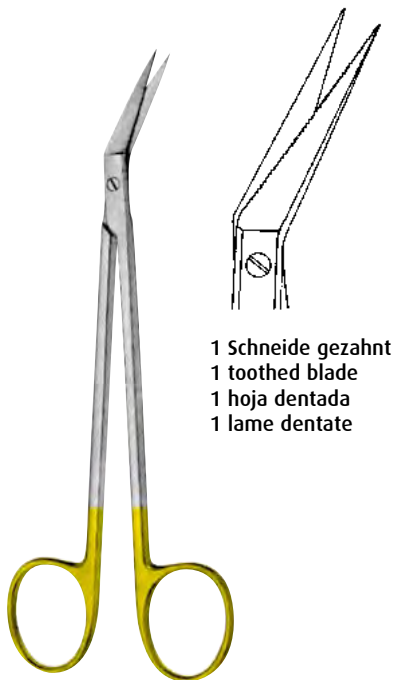

1 Schneide gezahnt
 1 toothed blade
 1 hoja dentada
 1 lame dentate

LOCKLIN

1125-1916 16,0 cm / 6 1/4"

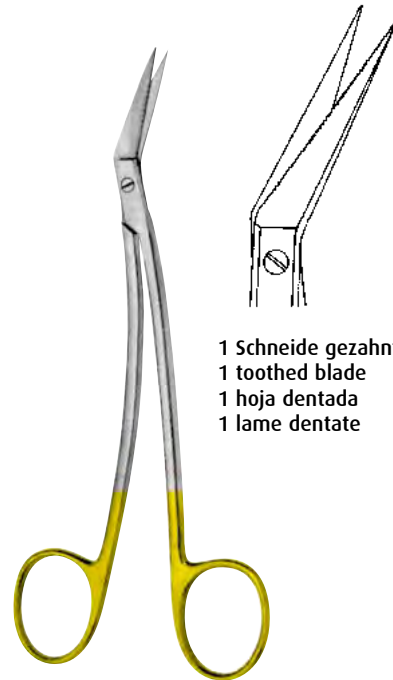

1 Schneide gezahnt
 1 toothed blade
 1 hoja dentada
 1 lame dentate

LOCKLIN

1125-2116 16,0 cm / 6 1/4"



RAGNELL (KILLNER)

1122-4512 12,0 cm / 4³/₄"

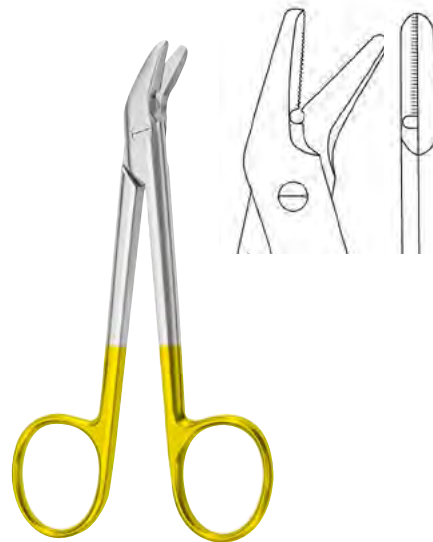

UNIVERSAL

1127-2112 12,0 cm / 4³/₄"

Super Cut

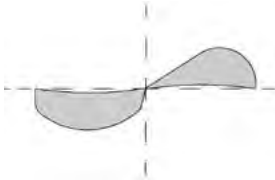

Standard

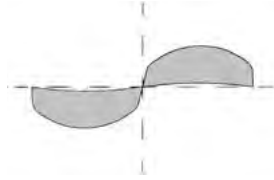

- Messerschiff für optimalen Schnitt
- 1 gezahntes Blatt verhindert das Herausgleiten des Gewebes
- schwarze Ringe

-
- Knife blade sharpness for optimum cutting
 - 1 serrated blade prevents tissue from slipping out
 - black-plated rings

-
- Filo tipo cuchillo para un corte óptimo
 - 1 hoja dentada impide el deslizamiento del tejido
 - anillos negros

-
- affilatura speciale per un ottimo taglio
 - Lama a denti micro
 - anelli neri





STANDARD

1110-0214 SC 14,5 cm / 5³/₄"



STANDARD

1110-0314 SC 14,5 cm / 5³/₄"

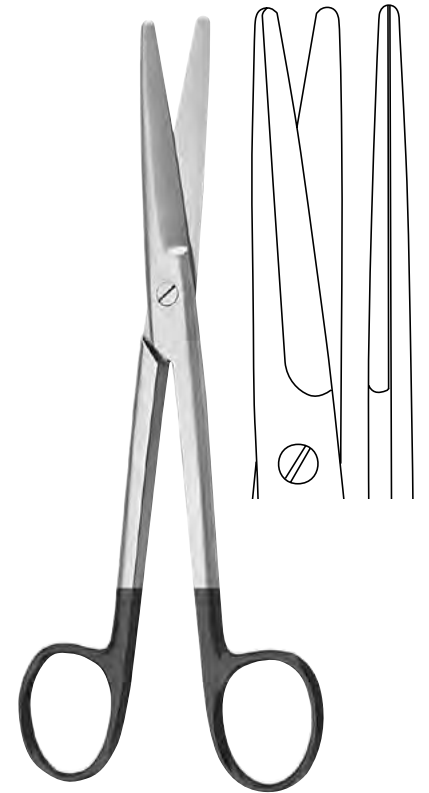

MAYO

1111-6014 SC 14,5 cm / 5³/₄"
1111-6017 SC 17,0 cm / 6³/₄"
1111-6023 SC 23,0 cm / 9"

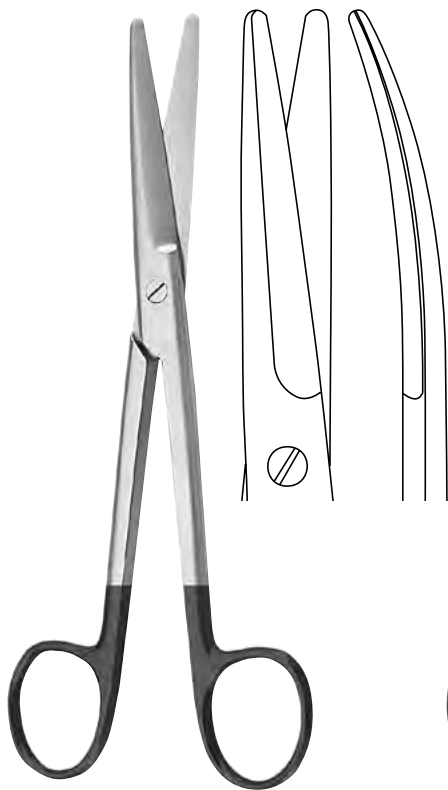

MAYO

1111-6114 SC 14,5 cm / 5³/₄"
1111-6117 SC 17,0 cm / 6³/₄"
1111-6123 SC 23,0 cm / 9"

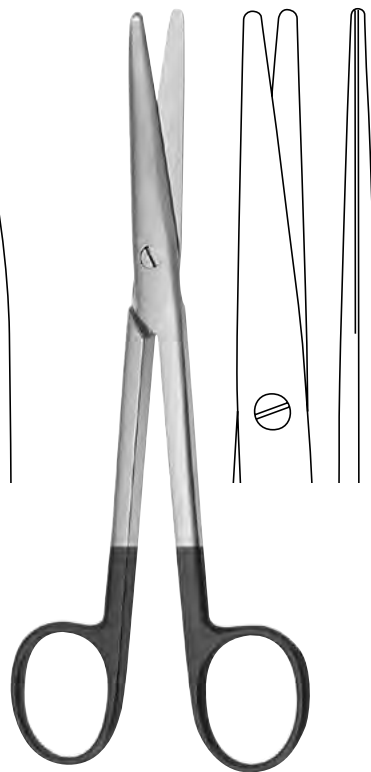

MAYO-STILLE

1111-7015 SC 15,0 cm / 6"
1111-7017 SC 17,0 cm / 6³/₄"

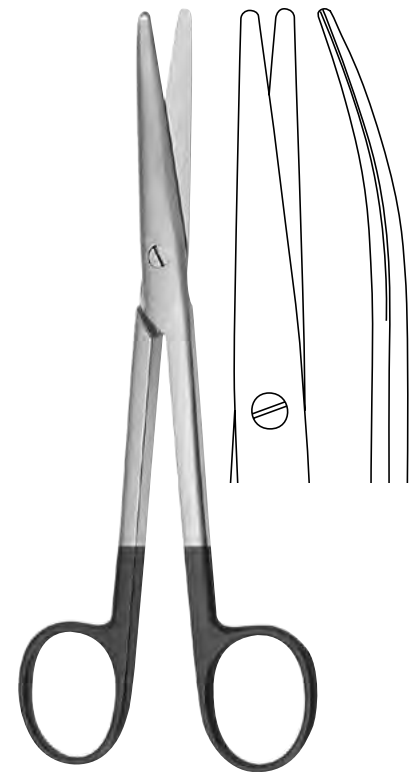

MAYO-STILLE

1111-7115 SC 15,0 cm / 6"
1111-7117 SC 17,0 cm / 6³/₄"



1112-2811 SC

1112-2911 SC



1112-0014 SC

1112-0114 SC

METZENBAUM

1112-2811 SC - 1112-2911 SC 11,5 cm / 4 1/2"

METZENBAUM

1112-0014 SC - 1112-0114 SC 14,5 cm / 5 1/2"

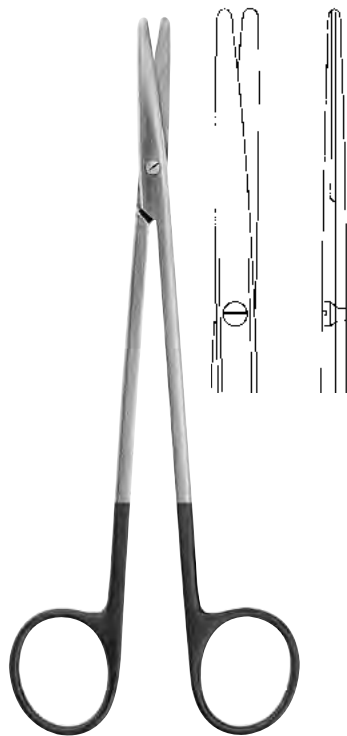

METZENBAUM-NELSON

1112-1918 SC 18,0 cm / 7"
 1112-1920 SC 20,0 cm / 8"
 1112-1923 SC 23,0 cm / 9"



METZENBAUM-NELSON

1112-2018 SC 18,0 cm / 7"
 1112-2020 SC 20,0 cm / 8"
 1112-2023 SC 23,0 cm / 9"



1112-3611 SC

1112-3711 SC

STRABISMUS

1112-3611 SC – 1112-3711 SC 11,5 cm / 4 1/2"



1112-3016 SC

1112-3116 SC

LEXER

1112-3016 SC – 1112-3116 SC 16,0 cm / 6 1/4"



1112-1014 SC

1112-1114 SC

METZENBAUM-FINO

1112-1014 SC – 1112-1114 SC 14,5 cm / 5 1/2"

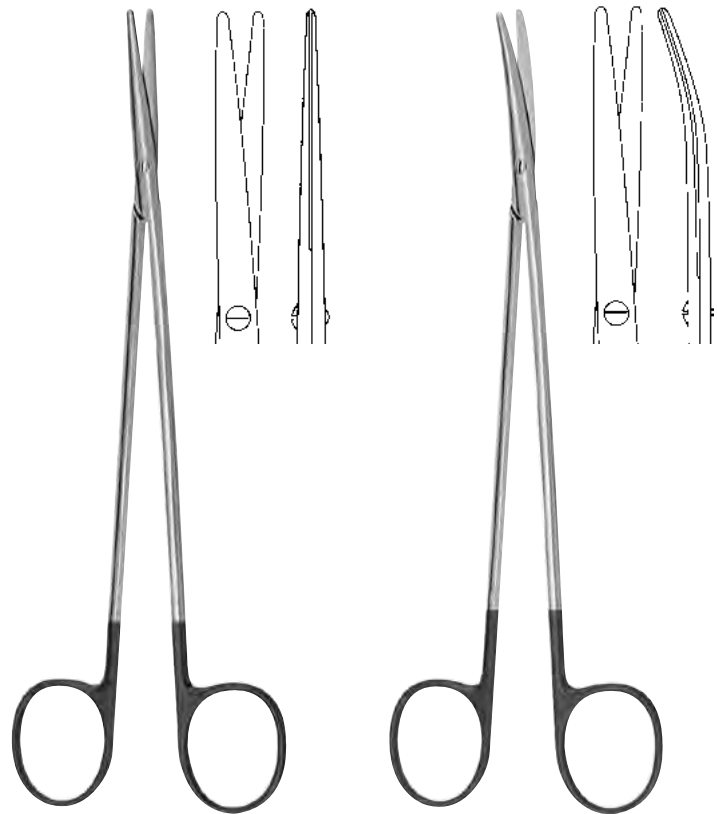

METZENBAUM-FINO

1112-1018 SC 18,0 cm / 7"
 1112-1020 SC 20,0 cm / 8"
 1112-1023 SC 23,0 cm / 9"

METZENBAUM-FINO

1112-1118 SC 18,0 cm / 7"
 1112-1120 SC 20,0 cm / 8"
 1112-1123 SC 23,0 cm / 9"



TOENNIS-ADSON

1112-5317 SC 17,5 cm / 7"

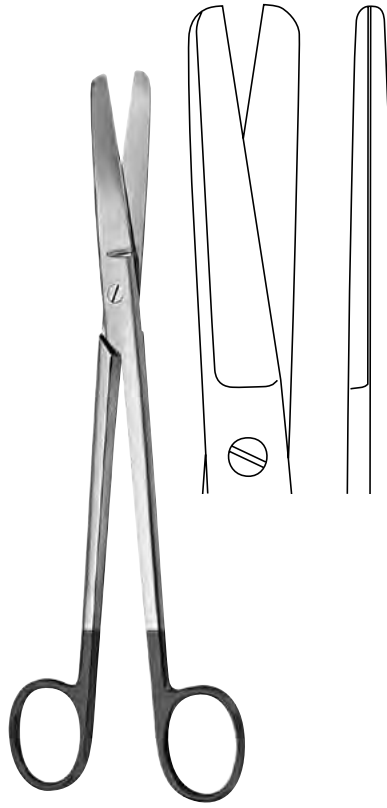

SIMS

1111-2020 SC 20,0 cm / 8"

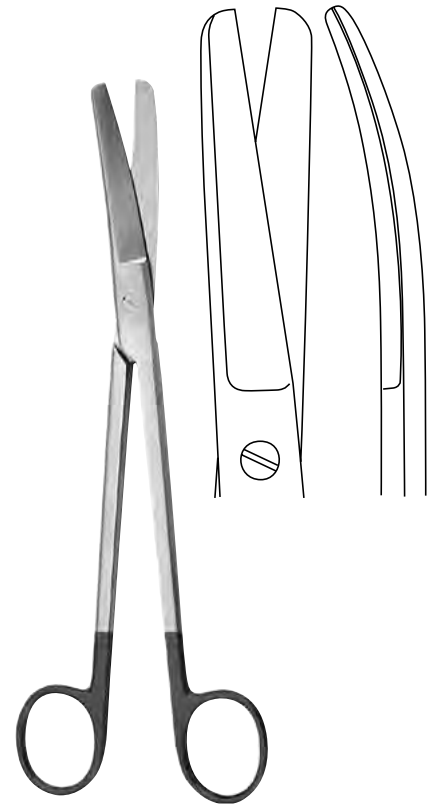

SIMS

1111-2120 SC 20,0 cm / 8"

1111-2123 SC 23,0 cm / 9"



SIEBOLD

1111-2724 SC 24,0 cm / 9 1/2"



WALDMANN

1111-4118 SC 18,0 cm / 7"



1111-4120 SC 20,0 cm / 8"

Episiotomiescheren
 Episiotomy scissors
 Tijeras para episiotomía
 Forbici per episiotomia

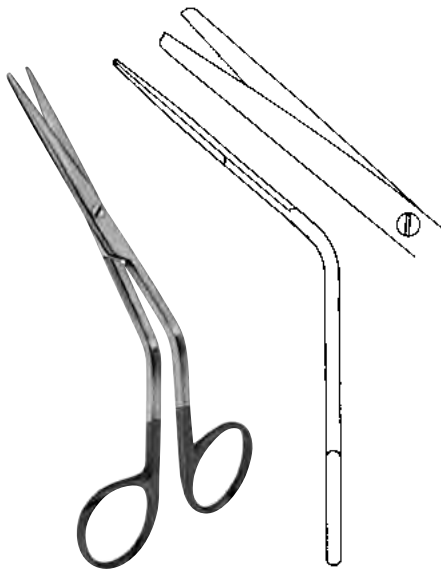

FOMON

1113-2913 SC 13,5 cm, 5 1/4"

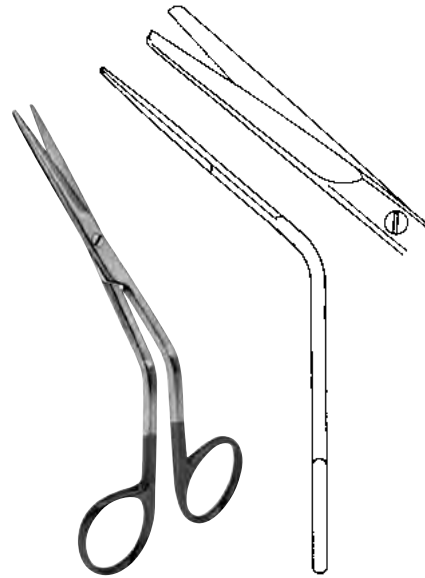

FOMON

1113-2714 SC 14,5 cm, 5 3/4"

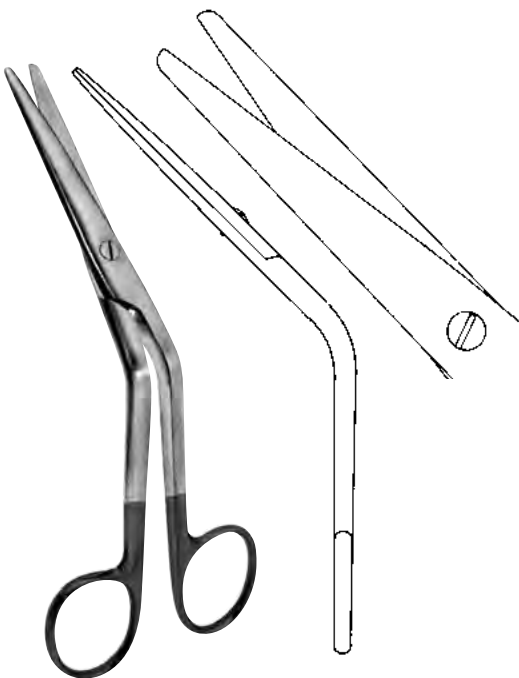

COTTLE

1113-3116 SC 16,0 cm / 6 1/4"



HEYMANN

1113-3518 SC 18,0 cm / 7"

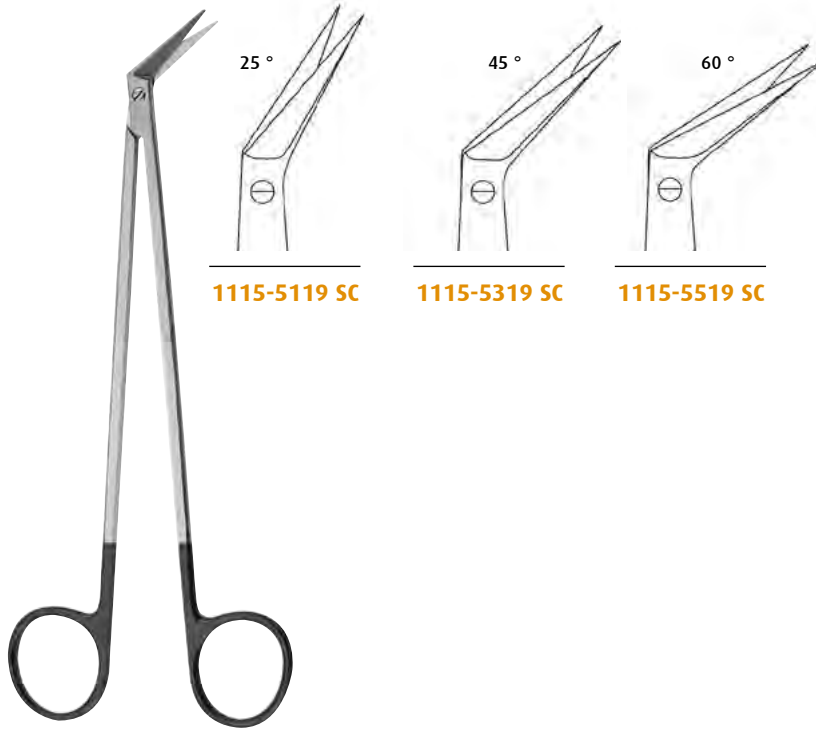

POTTS-SMITH

1115-5119 SC – 1115-5519 SC 19,0 cm / 7 1/2"

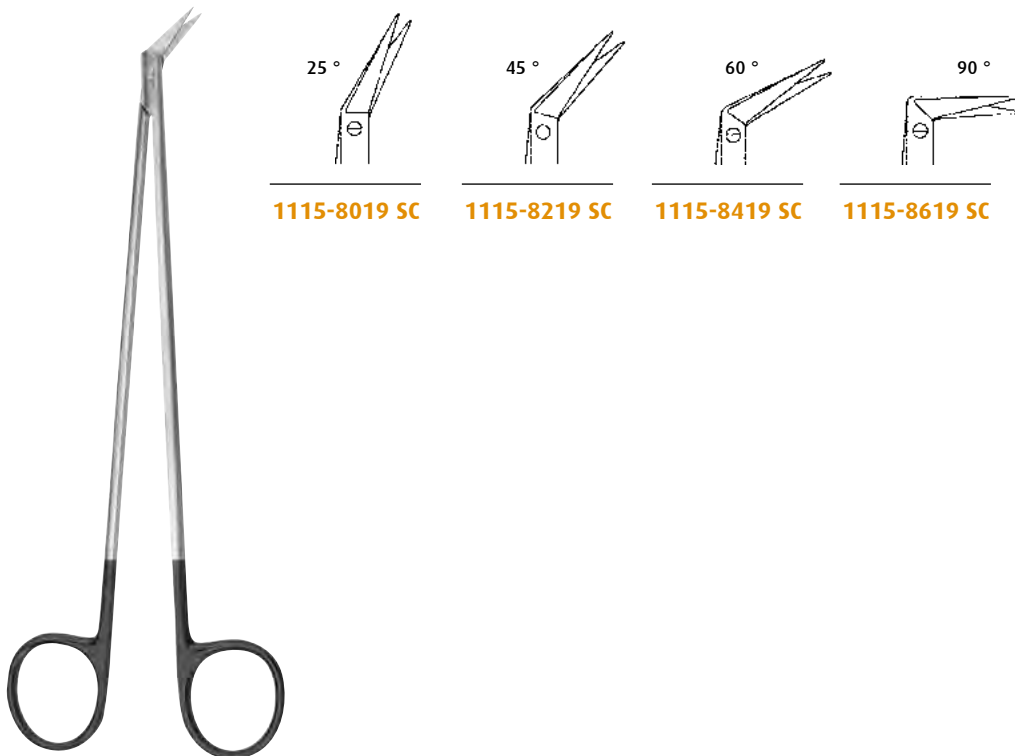

DIETRICH

1115-8019 SC – 1115-8619 SC 19,0 cm / 7 1/2"



1114-0016 SC

1114-0116 SC

Fistelscheren
 Fistula scissors
 Tijeras para fistulas
 Forbici per fistole

KELLY

1114-0016 SC – 1114-0116 SC 16,0 cm / 6 1/4"



1114-0414 SC

1114-0514 SC

JOSEPH

1114-0414 SC – 1114-0514 SC 14,0 cm, 5 1/2"



1114-4011 SC

1114-4111 SC

IRIS

1114-4011 SC – 1114-4111 SC 11,5 cm / 4 1/2"

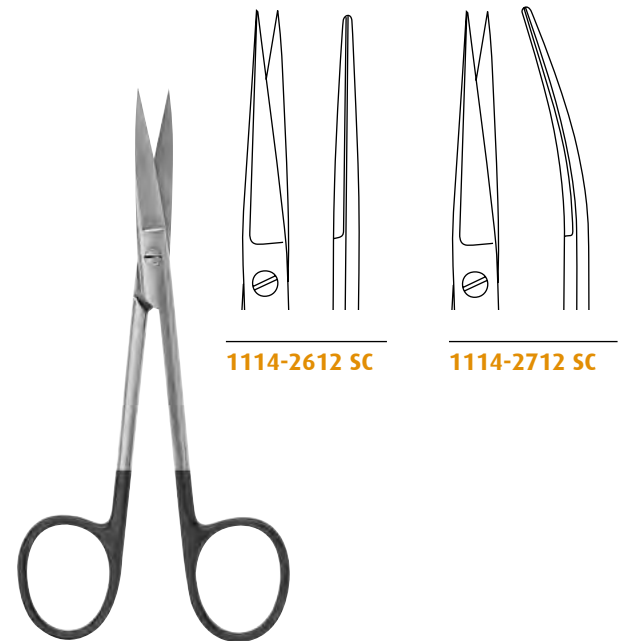

1114-2612 SC

1114-2712 SC

WAGNER

1114-2612 SC – 1114-2712 SC 12,0 cm / 4 3/4"



STEVENS

1114-3211 SC – 1114-3311 SC 11,5 cm / 4 1/2"

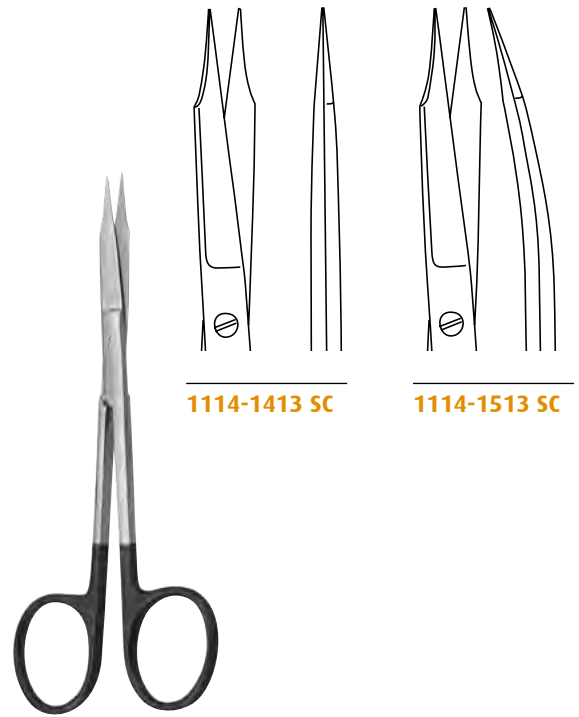

GOLDMANN-FOX

1114-1413 SC – 1114-1513 SC 13,0 cm / 5 1/8"

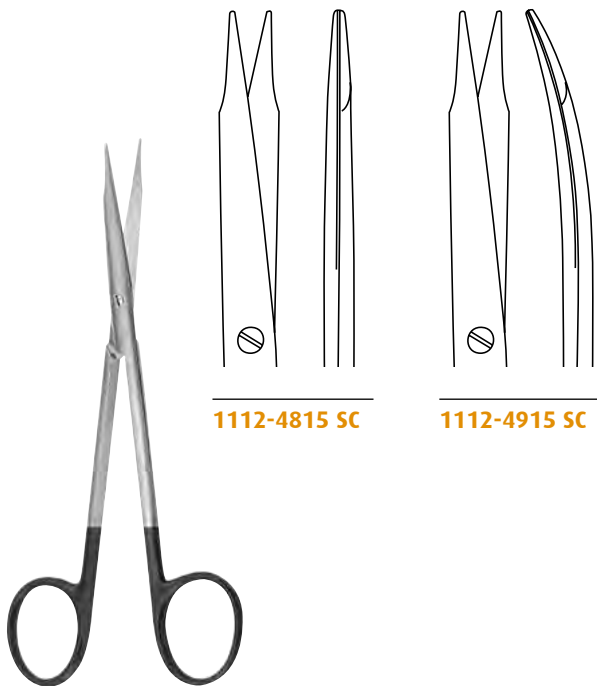

REYNOLDS

1112-4815 SC – 1112-4915 SC 15,0 cm / 6"

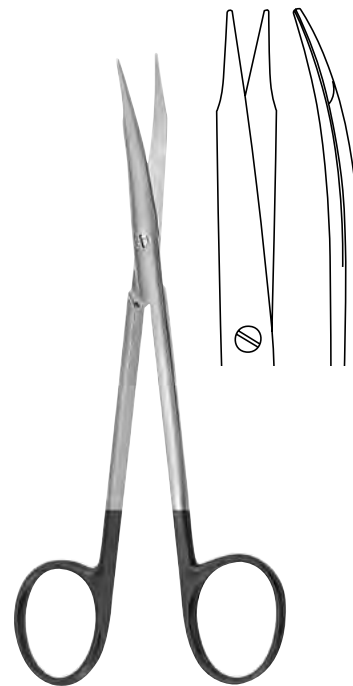

REYNOLDS

1112-4918 SC 17,5 cm / 7"

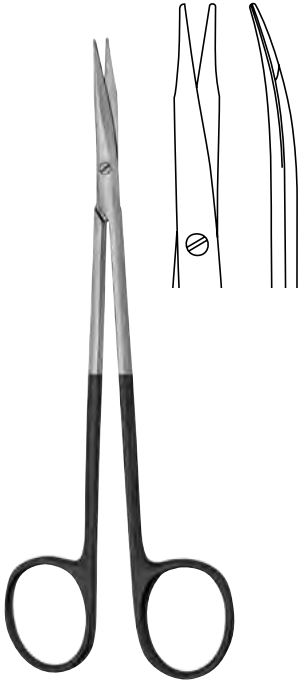

JAMESON

1112-4715 SC 15,0 cm / 6"



1112-3812 SC

1112-3912 SC

PAR-TYPE

1112-3812 SC – 1112-3912 SC 12,0 cm / 4³/₄"

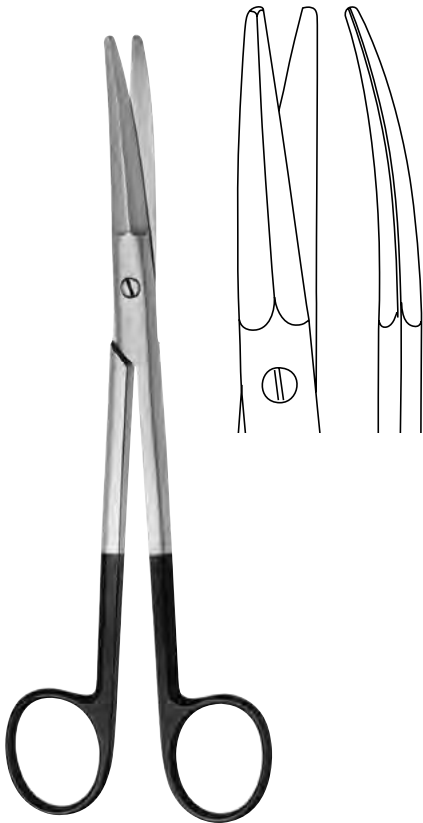

KAYE FACE LIFT

1112-4615 SC 15,0 cm / 6"
 1112-4919 SC 19,0 cm / 7¹/₂"

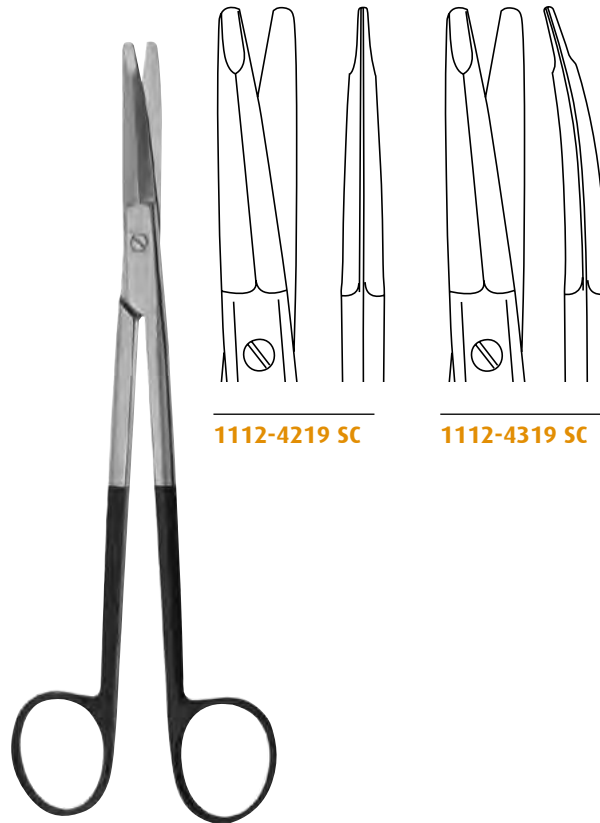

1112-4219 SC

1112-4319 SC

GORNEY

1112-4219 SC – 1112-4319 SC 19,0 cm / 7¹/₂"

Super-Cut Scheren
 Super-Cut Scissors
 Tijeras Super-Cut
 Forbici Super-Cut

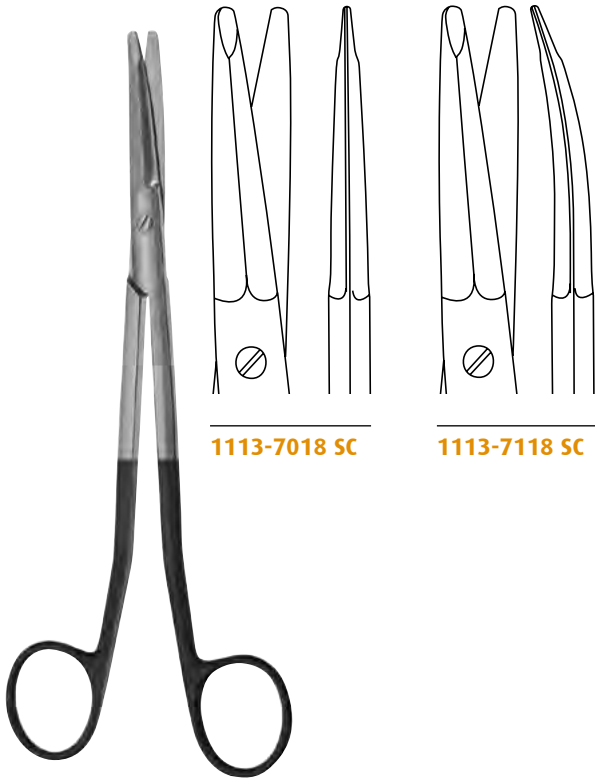

1113-7018 SC

1113-7118 SC

FREEMANN-KAYE

1113-7018 SC - 1113-7118 SC 18,0 cm / 7"

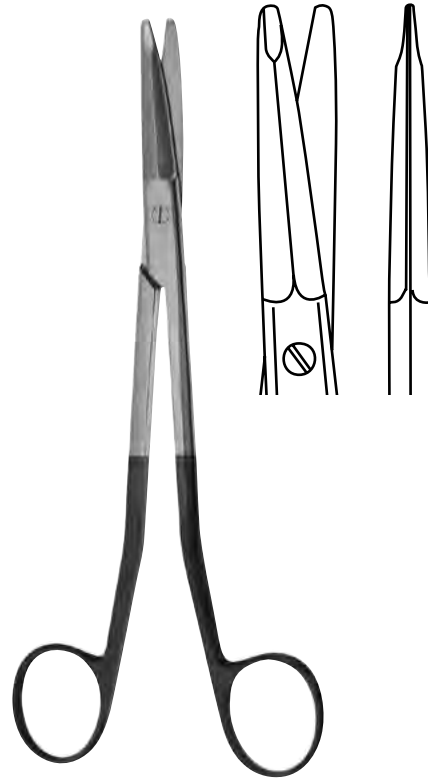

FREEMANN-GORNEY

1113-6819 SC 19,0 cm / 7 1/2"
 1113-6823 SC 23,0 cm / 9"

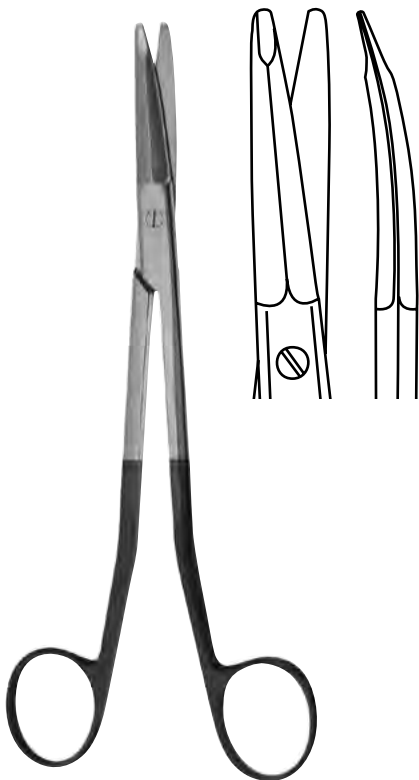

FREEMANN-GORNEY

1113-6919 SC 19,0 cm / 7 1/2"
 1113-6923 SC 23,0 cm / 9"



LISTER

1480-0714 SC 14,0 cm / 5 1/2"
 1480-0718 SC 18,0 cm / 7"
 1480-0720 SC 20,0 cm / 8"

012

**Super-Cut Scheren
Super-Cut Scissors
Tijeras Super-Cut
Forbici Super-Cut**

013

Pinzetten - anatomische, chirurgische, Mikro
Forceps - anatomics, surgicals, Micro
Pinzas - anatómicas, quirurgicas, Micro
Pinze - anatomiche, chirurgici, Micro

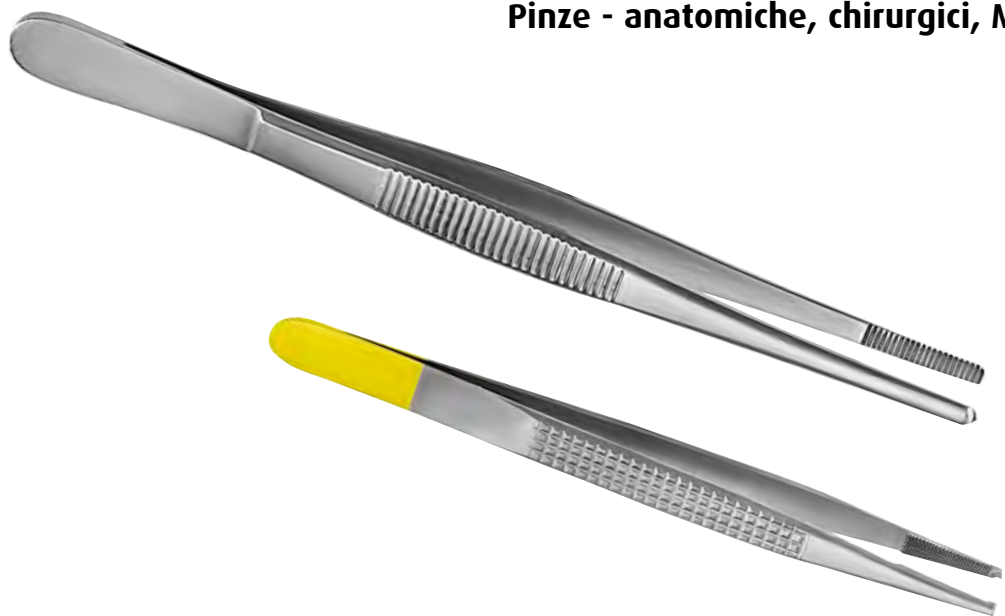



schmal
narrow
estrecha
stretti



STANDARD

1130-0010	10,5 cm / 4 ¹ / ₈ "
1130-0011	11,5 cm / 4 ¹ / ₂ "
1130-0013	13,0 cm / 5"
1130-0014	14,5 cm / 5 ³ / ₄ "
1130-0016	16,0 cm / 6 ¹ / ₄ "
1130-0018	18,0 cm / 7"
1130-0020	20,0 cm / 8"
1130-0025	25,0 cm / 10"
1130-0030	30,0 cm / 12"

STANDARD

1130-0211	11,5 cm / 4 ¹ / ₂ "
1130-0213	13,0 cm / 5"
1130-0214	14,5 cm / 5 ³ / ₄ "
1130-0216	16,0 cm / 6 ¹ / ₄ "
1130-0218	18,0 cm / 7"
1130-0220	20,0 cm / 8"
1130-0225	25,0 cm / 10"
1130-0230	30,0 cm / 12"

MOD. USA

1130-2012	12,0 cm / 4 ³ / ₄ "
1130-2013	13,0 cm / 5"
1130-2014	14,5 cm / 5 ³ / ₄ "
1130-2015	15,5 cm / 6"
1130-2018	18,0 cm / 7"
1130-2021	21,0 cm / 8"
1130-2025	25,0 cm / 10"
1130-2031	30,0 cm / 12"



schmal
narrow
estrecha
stretti



ADSON

1130-4212	12,0 cm / 4 ³ / ₄ "
1130-4215	15,0 cm / 6"



MICRO-ADSON

1130-4412	12,0 cm / 4 ³ / ₄ "
1130-4415	15,0 cm / 6"

MOD. USA

1130-2212	12,0 cm / 4 ³ / ₄ "
1130-2213	13,0 cm / 5"
1130-2214	14,5 cm / 5 ³ / ₄ "
1130-2215	15,5 cm / 6 ¹ / ₈ "

Anatomische Pinzetten
Dissecting Forceps
Pinzas de disección
Pinze anatomiche per dissezione



MC INDOE

1130-5015 15,0 cm / 6"



SEMKEN

1130-5412 12,5 cm / 5"
1130-5415 15,0 cm / 6"



POTTS-SMITH

1130-6418 18,0 cm / 7"
1130-6421 21,0 cm / 8¹/₄"
1130-6425 25,0 cm / 10"



POTTS-SMITH

1130-6518 18,0 cm / 7"
1130-6521 21,0 cm / 8¹/₄"
1130-6525 25,0 cm / 10"



BROPHY

1130-6820 20,0 cm / 8"



BROPHY

1130-6920 20,0 cm / 8"



TAYLOR

1130-5817 17,5 cm / 7"



TAYLOR

1130-6117 17,5 cm / 7"

Dissektor Ende
dissector end
cabo disecador
dissettore



CUSHING
1130-6617 17,5 cm / 7"



CUSHING
1130-6717 17,5 cm / 7"



GERALD
1130-7018 18,0 cm / 7"



GERALD
1130-7118 18,0 cm / 7"



englische Modelle
 english patterns
 modelos ingleses
 modelli inglese

1130-7312 12,5 cm / 5"
1130-7315 15,5 cm / 6¹/₈"



DUEHRSEN
1130-7220 20,0 cm / 8"



RAMSEY
1130-7618 18,0 cm / 7"

Chirurgische Pinzetten
Tissue Forceps
Pinzas quirúrgicas
Pinze per chirurgia

013



 1x2

STANDARD

1131-0010	10,5 cm / 4 ¹ / ₈ "
1131-0011	11,5 cm / 4 ¹ / ₂ "
1131-0013	13,0 cm / 5"
1131-0014	14,5 cm / 5 ³ / ₄ "
1131-0016	16,0 cm / 6 ¹ / ₄ "
1131-0018	18,0 cm / 7"
1131-0020	20,0 cm / 8"
1131-0025	25,0 cm / 10"
1131-0030	30,0 cm / 12"



 2x3

1131-2411	11,5 cm / 4 ¹ / ₂ "
1131-2413	13,0 cm / 5"
1131-2414	14,5 cm / 5 ³ / ₄ "
1131-2416	16,0 cm / 6 ¹ / ₄ "
1131-2418	18,0 cm / 7"
1131-2420	20,0 cm / 8"
1131-2425	25,0 cm / 10"
1131-2430	30,0 cm / 12"



 3x4

1131-2613	13,0 cm / 5"
1131-2614	14,5 cm / 5 ³ / ₄ "
1131-2616	16,0 cm / 6 ¹ / ₄ "



 4x5

1131-2813	13,0 cm / 5"
1131-2814	14,5 cm / 5 ³ / ₄ "
1131-2816	16,0 cm / 6 ¹ / ₄ "

schmal
narrow
estrecha
stretti



 1x2

1131-0211	11,5 cm / 4 ¹ / ₂ "
1131-0213	13,0 cm / 5"
1131-0214	14,5 cm / 5 ³ / ₄ "
1131-0216	16,0 cm / 6 ¹ / ₄ "
1131-0218	18,0 cm / 7"
1131-0220	20,0 cm / 8"



 1x2

1131-0513	13,0 cm / 5"
1131-0514	14,5 cm / 5 ³ / ₄ "



USA MODELL

- 1131-2212** 12,0 cm / 4³/₄"
- 1131-2213** 13,0 cm / 5"
- 1131-2214** 14,5 cm / 5³/₄"
- 1131-2215** 15,5 cm / 6"
- 1131-2218** 18,0 cm / 7"
- 1131-2221** 21,0 cm / 8¹/₄"
- 1131-2225** 25,0 cm / 9³/₄"
- 1131-2231** 31,0 cm / 12¹/₄"



USA MODELL

- 1131-2013** 13,0 cm / 5"
- 1131-2014** 14,5 cm / 5³/₄"
- 1131-2015** 15,5 cm / 6"



STILLE

- 1131-2915** 15,0 cm / 6"



STILLE

- 1131-3015** 15,0 cm / 6"



ADSON

- 1131-4212** 12,0 cm / 4³/₄"
- 1131-4215** 15,0 cm / 6"



MIKRO-ADSON

- 1131-4412** 12,0 cm / 4³/₄"
- 1131-4415** 15,0 cm / 6"



ADSON

- 1131-4612** 12,0 cm / 4³/₄"



ADSON-BROWN

- 1131-9112** 12,0 cm / 4³/₄"



STONE
1131-9415 15,0 cm / 6"



LERCHE
1131-9615 15,0 cm / 6"



ADLERKREUTZ
1131-7315 15,0 cm / 6"
1131-7320 20,0 cm / 8"



ADLERKREUTZ
1131-7215 15,0 cm / 6"
1131-7220 20,0 cm / 8"



GILLIES
1131-5215 15,0 cm / 6"



SEMKEN
1131-5412 12,5 cm / 5"
1131-5415 15,0 cm / 6"



TAYLOR
1131-5617 17,5 cm / 7"



TAYLOR
1131-6117 17,5 cm / 7"



GERALD
1131-7018 17,5 cm / 7"



GERALD
1131-7118 17,5 cm / 7"



CUSHING
1131-6617 17,5 cm / 7"



CUSHING
1131-6717 17,5 cm / 7"



POTTS-SMITH
1131-6418 18,0 cm / 7"
1131-6421 21,0 cm / 8¹/₄"
1131-6425 25,0 cm / 10"



POTTS-SMITH
1131-6518 18,0 cm / 7"
1131-6521 21,0 cm / 8¹/₄"
1131-6525 25,0 cm / 10"



BROPHY
1131-6820 20,0 cm / 8"



BROPHY
1131-6920 20,0 cm / 8"

Chirurgische Pinzetten
Tissue Forceps
Pinzas quirúrgicas
Pinze per chirurgia

013



WAUGH
1131-0620 20,0 cm / 8"



DUEHRSEN
1131-8001 20,0 cm / 8"



STILLE-BARRAYA
1131-8218 18,0 cm / 7"
1131-8220 20,0 cm / 8"
1131-8225 25,0 cm / 10"



FERRIS-SMITH
1131-7618 - 1131-7718 18,0 cm / 7"

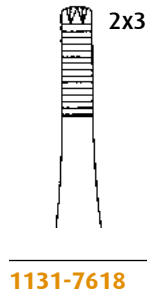

LANE
1131-7814 14,5 cm / 5³/₄"
1131-7818 17,5 cm / 7"



LANE
1131-7914 14,5 cm / 5³/₄"
1131-7918 17,5 cm / 7"

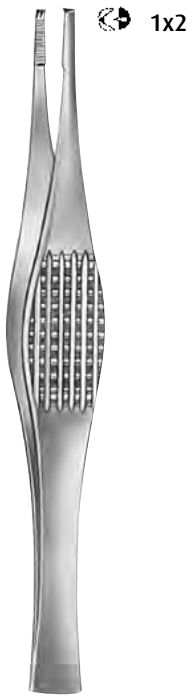

RAMSEY
1132-7818 18,0 cm / 7"

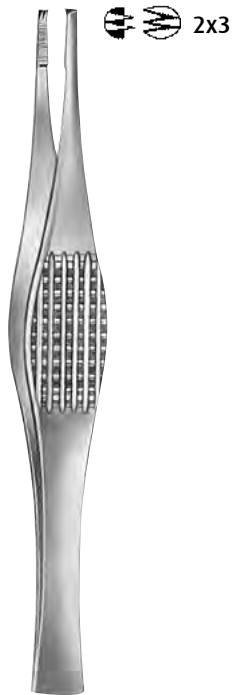

RAMSEY
1132-7918 18,0 cm / 7"



BONNEY
1131-7518 18,0 cm / 7"



BONNEY
1131-7418 18,0 cm / 7"



TREVES
1131-8913 13,0 cm / 5"
1131-8915 15,0 cm / 6"



BROWN
1131-8815 15,0 cm / 6"



DURANTE
1131-9814 14,5 cm / 5³/₄"
1131-9816 16,0 cm / 6¹/₄"
1131-9820 20,0 cm / 8"



RUSS. MODELL
1130-8415 15,0 cm / 6"
1130-8420 20,0 cm / 8"
1130-8425 25,0 cm / 10"



NELSON
1131-8323 23,0 cm / 9"



DUVAL
1130-9614 14,0 cm / 5 1/2"



COLLIN-DUVAL
1130-9801 - 1130-9803 20,0 cm / 8"



FIG. 1
1130-9801

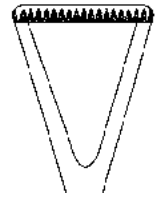

FIG. 2
1130-9802

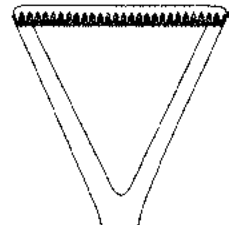

FIG. 3
1130-9803



SINGLEY-TUTTLE
1130-8823 23,0 cm / 9"



DENIS-BROWNE
1130-9120 20,0 cm / 8"



GRAEFE
1130-3410 10,0 cm / 4"



GRAEFE
1130-3511 10,0 cm / 4"



GRAEFE
1130-3510 10,0 cm / 4"

↔ 1x2



GRAEFE
1131-3410 10,0 cm / 4"

↔ 1x2



GRAEFE
1131-3511 10,0 cm / 4"

↔ 1x2



GRAEFE
1131-3510 10,0 cm / 4"

Splitterpinzetten, Mikro-Pinzetten
Splinter Forceps, Micro Forceps
Pinzas para espinas, Pinzas para microscopia
Pinze per schegge, Pinze per microscopia



ohne Stift
without pin
sin perno
senza perno



mit Stift
with pin
con perno
con perno



- 1135-1208** 8,0 cm / 3 1/4"
- 1135-1209** 9,0 cm / 3 1/2"
- 1135-1210** 10,5 cm / 4 1/8"
- 1135-1211** 11,5 cm / 4 1/2"
- 1135-1212** 12,5 cm / 5"

- 1135-1308** 8,0 cm / 3 1/4"
- 1135-1309** 9,0 cm / 3 1/2"
- 1135-1310** 10,5 cm / 4 1/8"
- 1135-1311** 11,5 cm / 4 1/2"
- 1135-1312** 12,5 cm / 5"

- 1137-1208** 8,0 cm / 3 1/4"
- 1137-1209** 9,0 cm / 3 1/2"
- 1137-1210** 10,5 cm / 4 1/8"
- 1137-1211** 11,5 cm / 4 1/2"
- 1137-1212** 12,5 cm / 5"

- 1137-1308** 8,0 cm / 3 1/4"
- 1137-1309** 9,0 cm / 3 1/2"
- 1137-1310** 10,5 cm / 4 1/8"
- 1137-1311** 11,5 cm / 4 1/2"
- 1137-1312** 12,5 cm / 5"



- HUNTER**
1135-1810 10,5 cm / 4 1/4"

- HUNTER**
1135-1910 10,5 cm / 4 1/4"

- WALTER-CARMALT**
1135-1610 10,5 cm / 4 1/4"

- WALTER-CARMALT**
1135-1710 10,5 cm / 4 1/4"



1135-3010 10,0 cm / 4"



1135-3110 10,0 cm / 4"



1135-3210 10,0 cm / 4"



FEILCHENFELD

- 1135-2207** 7,5 cm / 3¹/₈"
- 1135-2209** 9,0 cm / 3¹/₂"
- 1135-2211** 11,5 cm / 4¹/₂"



SHAAF

1135-0209 9,0 cm / 3¹/₂"



LITTAUER

1135-1008 8,5 cm / 3¹/₃"



1135-0809 9,0 cm / 3¹/₂"



DOUGLAS

1135-0009 9,0 cm / 3¹/₂"

Splitterpinzetten, Cilienpinzetten, Uhrmacher Pinzetten
 Splinter Forceps, Cilia Forceps, Jeweller`s Forceps
 Pinzas para espinas, Pinzas depilatorias, Pinzas de relojero
 Pinze per schegge, Pinze depilatoria, Pinze per orologiaio



DOUGLAS

1135-0109 9,0 cm / 3 1/2"



BEER

1135-0409 9,0 cm / 3 1/2"



BARRAQUER

1135-1110 10,5 cm / 4 1/4"



FIG. 3

1136-1603 11,5 cm / 4 3/4"



FIG. 4

1136-1604 11,0 cm / 4 3/8"



FIG. 5

1136-1605 11,0 cm / 4 3/8"



FIG. 7

1136-1707 11,5 cm / 4 3/8"

0,3 mm



1136-1801 11,0 cm / 4³/₈"

0,3 mm x 90°



1136-1802 11,0 cm / 4³/₈"

0,3 mm x 45°



1136-1803 11,0 cm / 4³/₈"

0,3 mm x 45°



1136-1804 11,0 cm / 4³/₈"

9 mm
 diamantbeschichtet
 diamond coated
 diamantato
 diamantato

0,3 mm



1136-1912 12,0 cm / 4³/₄"

0,3 mm x 45°



1136-1913 13,5 cm / 5¹/₄"

Tumor- und Gewebefäßpinzetten
Tumor and Tissue Grasping Forceps
Pinzas de agarre para tejido y tumor
Pinze per afferare tessuti e tumori



Ø 3 mm

1136-3122

Ø 5 mm

1136-3322

YASARGIL

1136-3122 - 1136-3322

22,0 cm / 8³/₄"



Ø 3 mm

1136-3522

Ø 5 mm

1136-3722

YASARGIL

1136-3522 - 1136-3722

22,0 cm / 8³/₄"



Ø 3 mm

1136-3922

Ø 5 mm

1136-4122

HEIFETZ

1136-3922 - 1136-4122

22,0 cm / 8³/₄"

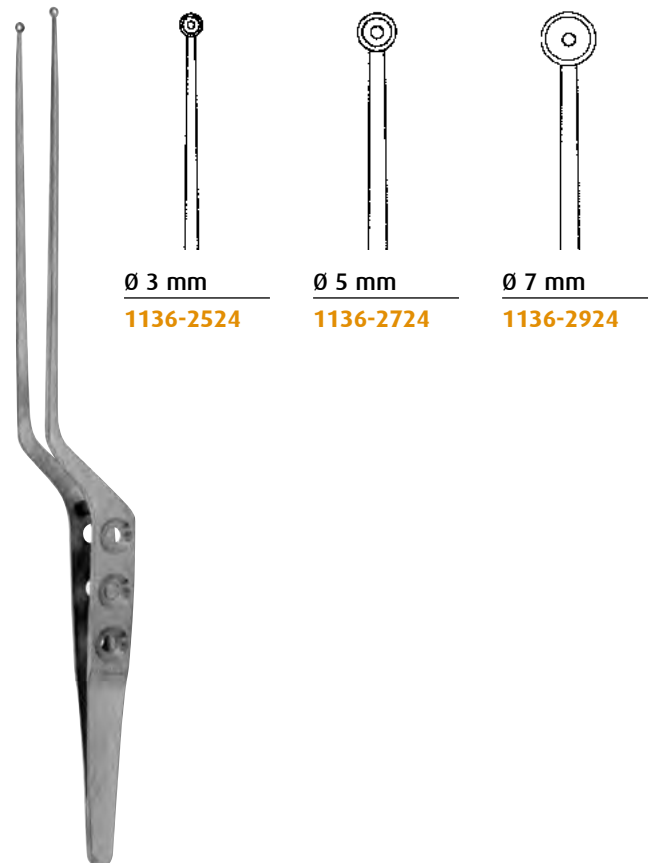

Ø 3 mm

1136-2524

Ø 5 mm

1136-2724

Ø 7 mm

1136-2924

YASARGIL-SAMI

1136-2524 - 1136-2924

24,0 cm / 9¹/₂"

013

Tumor- und Gewebefaßpinzetten, Mikro-Pinzetten Tumor and Tissue Grasping Forceps, Micro-Forceps Pinzas de agarre para tejido y tumor, Micro-Pinzas Pinze per afferare tessuti e tumori, Micro-Pinze



SAMI

1136-4323 23,0 cm / 9"



SAMI

1136-4923 23,0 cm / 9"



HUNT

1136-5920 20,0 cm / 8"



YASARGIL

1136-2118 18,0 cm / 7"
1136-2120 20,0 cm / 8"
1136-2122 22,0 cm / 8³/₄"
1136-2124 24,0 cm / 9¹/₂"



YASARGIL

1136-2318 18,0 cm / 7"
1136-2320 20,0 cm / 8"
1136-2322 22,0 cm / 8³/₄"
1136-2324 24,0 cm / 9¹/₂"







YASARGIL



1136-2418 18,0 cm / 7"

Mikro-Knüpfpinzetten
Micro Suture Tying Forceps
Micro Pinzas de ligadura
Micro Pinze per legature



	0,3 mm		0,3 mm
<hr/>		<hr/>	
1136-1215	15,0 cm / 6"	1136-1315	15,0 cm / 6"
1136-1218	18,0 cm / 7"	1136-1318	18,0 cm / 7"
1136-1221	21,0 cm / 9"	1136-1321	21,0 cm / 8 ¹ / ₄ "
	0,3 mm		0,3 mm
<hr/>		<hr/>	
1136-0915	15,0 cm / 6"	1136-0715	15,0 cm / 6"
1136-0918	18,0 cm / 7"	1136-0718	18,0 cm / 7"
1136-0921	21,0 cm / 8 ¹ / ₄ "	1136-0721	21,0 cm / 8 ¹ / ₄ "

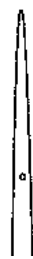

		
0,3 mm	0,6 mm	0,6 mm
<hr/>	<hr/>	<hr/>
1136-2001	1136-2002	1136-2003

1136-2001 - 1136-2003 18,5 cm / 7¹/₄"



AUSTIN
 1136-0014 14,0 cm / 5 1/2"



1136-0418 18,5 cm / 7 1/4"

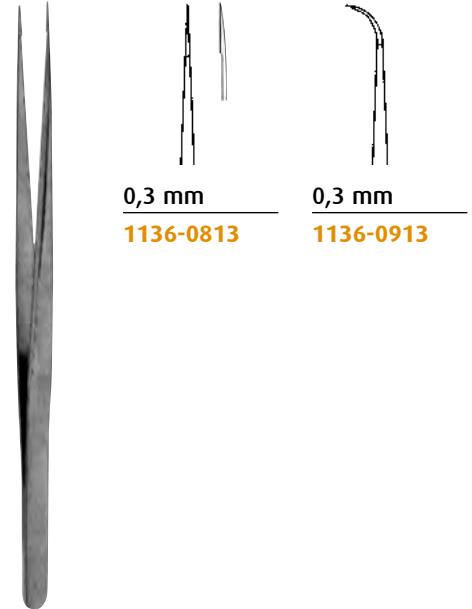

VISE
 1136-0813 - 1136-0913 13,5 cm / 5 1/4"

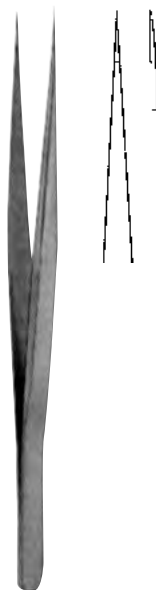

1136-0612 12,0 cm / 4 3/4"

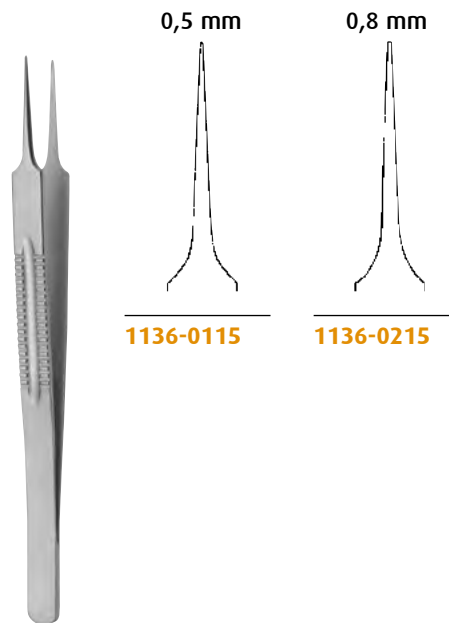

LAZAR
 1136-0115 - 1136-0215 15,5 cm / 6 1/8"

Pinzetten mit Hartmetalleinlagen
Forceps with tungsten carbide inserts
Pinzas con bocas de carburo tungsteno
Pinze con morsi in carburo di tungsteno

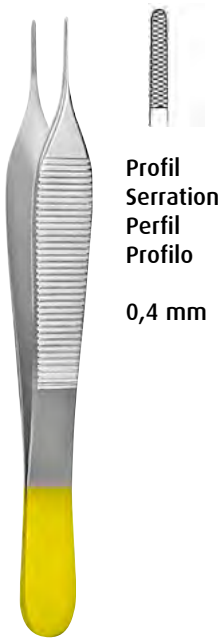

Profil
 Serration
 Perfil
 Profilo
 0,4 mm

ADSON

- 1140-4412** 12,0 cm / 4³/₄"
- 1140-4415** 15,0 cm / 6"



Profil
 Serration
 Perfil
 Profilo
 0,4 mm

MICRO-ADSON

- 1140-4612** 12,0 cm / 4³/₄"
- 1140-4615** 15,0 cm / 6"



Profil
 Serration
 Perfil
 Profilo
 0,4 mm

STANDARD

- 1140-0214** 14,5 cm / 5³/₄"
- 1140-0216** 16,0 cm / 6¹/₄"
- 1140-0218** 18,0 cm / 7"
- 1140-0220** 20,0 cm / 8"
- 1140-0225** 25,0 cm / 10"



1140-6618
 Profil
 Serration
 Perfil
 Profilo
 0,4 mm

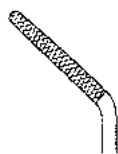

1140-6718
 Profil
 Serration
 Perfil
 Profilo
 0,4 mm



Profil
 Serration
 Perfil
 Profilo
 0,4 mm



CUSHING

- 1140-6618 - 1140-6718** 17,5 cm / 7"

CUSHING-TAYLOR

- 1140-6118** 18,0 cm / 7"

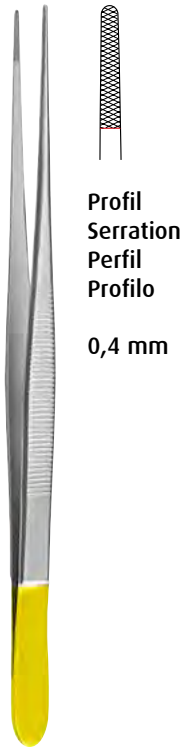

Profil
Serration
Perfil
Profilo
0,4 mm



Profil
Serration
Perfil
Profilo
0,4 mm

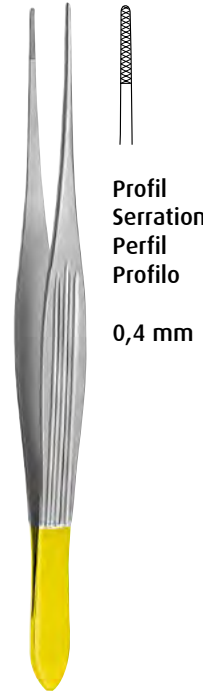

Profil
Serration
Perfil
Profilo
0,4 mm

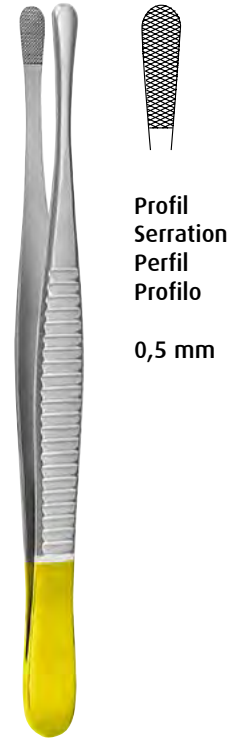

Profil
Serration
Perfil
Profilo
0,5 mm

POTTS-SMITH

- 1140-6415** 15,0 cm / 6"
- 1140-6418** 18,0 cm / 7"
- 1140-6420** 20,0 cm / 8"
- 1140-6423** 23,0 cm / 9"
- 1140-6425** 25,0 cm / 10"

SEMKEN

- 1140-5415** 15,0 cm / 6"

MC INDOE

- 1140-5015** 15,0 cm / 6"

WANGENSTEEN

- 1140-8615** 15,0 cm / 6"
- 1140-8623** 23,0 cm / 9"
- 1140-8625** 25,0 cm / 10"



Profil
Serration
Perfil
Profilo
0,4 mm



Profil
Serration
Perfil
Profilo
0,4 mm

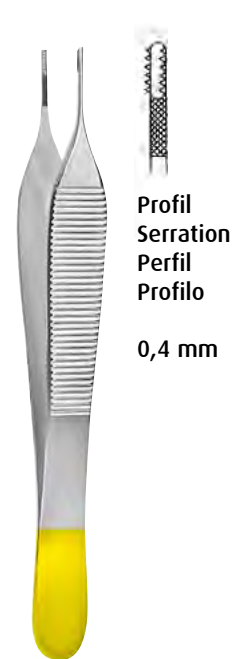

Profil
Serration
Perfil
Profilo
0,4 mm

ADSON

- 1141-4212** 12,0 cm / 4³/₄"
- 1141-4215** 15,0 cm / 6"

MICRO-ADSON

- 1141-4412** 12,0 cm / 4³/₄"
- 1141-4615** 15,0 cm / 6"

ADSON-BROWN

- 1141-9112** 12,0 cm / 4³/₄"

Pinzetten mit Hartmetalleinlagen
Forceps with tungsten carbide inserts
Pinzas con bocas de carburo tungsteno
Pinze con morsi in carburo di tungsteno

013



Profil
Serration
Perfil
Profilo
0,4 mm



BONNEY

1141-7518 18,0 cm / 7"

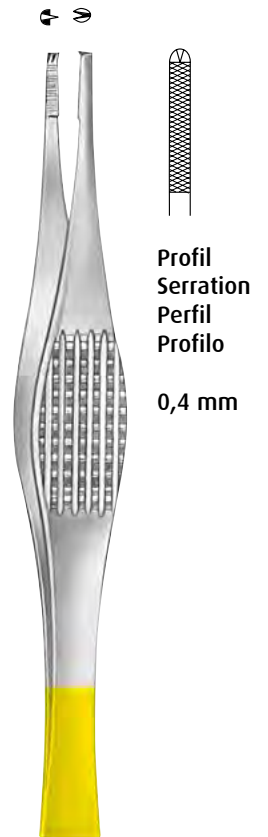

Profil
Serration
Perfil
Profilo
0,4 mm

OEHLER

1141-0214 14,0 cm / 5 1/2"
1141-0216 16,0 cm / 6 1/4"
1141-0218 18,0 cm / 7"
1141-0220 20,0 cm / 8"
1141-0225 25,0 cm / 10"
1141-0230 30,0 cm / 12"

FERRIS-SMITH

1141-7618 18,0 cm / 7"

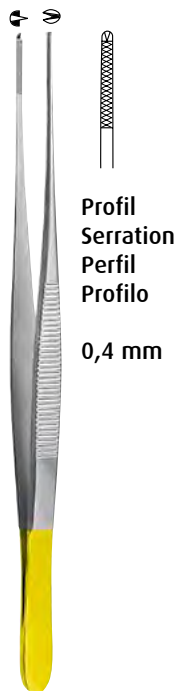

Profil
Serration
Perfil
Profilo
0,4 mm

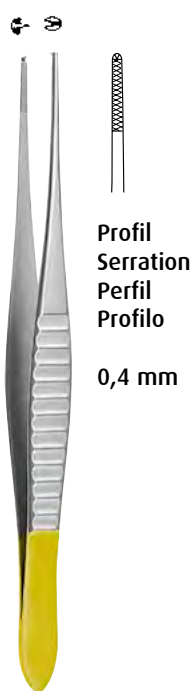

Profil
Serration
Perfil
Profilo
0,4 mm



1142-1016
1142-1020
1142-1024



1142-0816
1142-0820
1142-0824

SEMKEN

1141-5415 15,0 cm / 6"

GILLIES

1141-5215 15,0 cm / 6"

DEBAKEY

1142-1016 - 1142-0816 16cm 6 1/4"
1142-1020 - 1142-0820 20cm 8"
1142-1024 - 1142-0824 24cm 9 1/2"



1500-5813

1500-5913

STIEGLITZ

1500-5813 - 1500-5913

13,5 cm / 5 1/4"



013-992-135

1500-5713

STIEGLITZ

1500-5613 - 1500-5713

13,5 cm / 5 1/4"

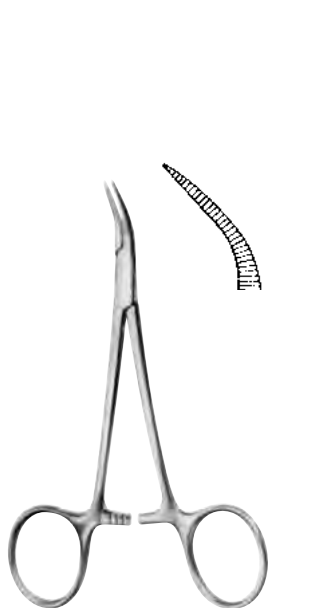

PEET

1500-5511 11,5 cm / 4 1/2"

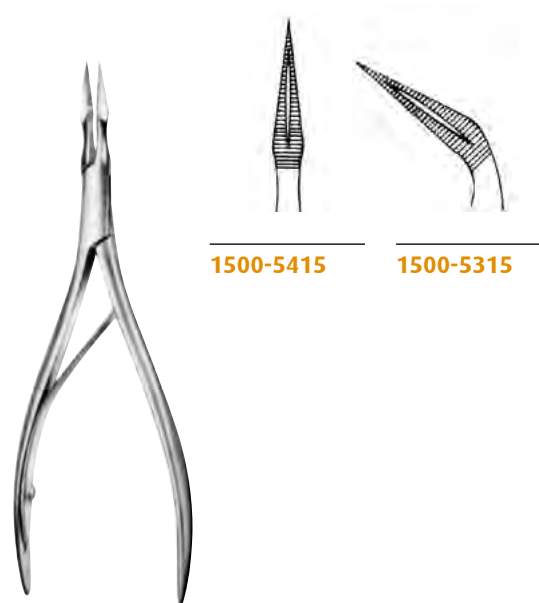

1500-5415

1500-5315

RALK (VIRTUS)

1500-5415 - 1500-5315

15,0 cm / 6"

015

Arterienklemmen, Korn- und Tupferzangen
Artery Forceps, Dressing and Sponge Forceps
Pinzas hemostáticas, Pinzas para torundo y vendajes
Pinze emostatiche, Pinze per medicatura e tamponi





1155-2430



1155-2435



1155-2440

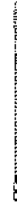

1155-2450

TITANIUM VENA

1155-2430	30 mm
1155-2435	35 mm
1155-2440	40 mm
1155-2450	50 mm



1155-2830

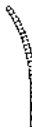

1155-2835

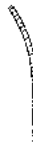

1155-2840



1155-2850

TITANIUM VENA

1155-2830	30 mm
1155-2835	35 mm
1155-2840	40 mm
1155-2850	50 mm



1155-2630



1155-2635



1155-2640



1155-2650

TITANIUM ARTERIA

1155-2630	30 mm
1155-2635	35 mm
1155-2640	40 mm
1155-2650	50 mm



1155-2730

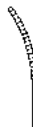

1155-2735



1155-2740



1155-2750

TITANIUM ARTERIA

1155-2730	30 mm
1155-2735	35 mm
1155-2740	40 mm
1155-2750	50 mm



1155-2530
1155-2930



1155-2535
1155-2935



1155-2540
1155-2940



1155-2550
1155-2950



TITANIUM VENA

1155-2530	30 mm
1155-2535	35 mm
1155-2540	40 mm
1155-2550	50 mm

TITANIUM ARTERIA

1155-2930	30 mm
1155-2935	35 mm
1155-2940	40 mm
1155-2950	50 mm



1155-3025 24,0 cm / 9 1/2"

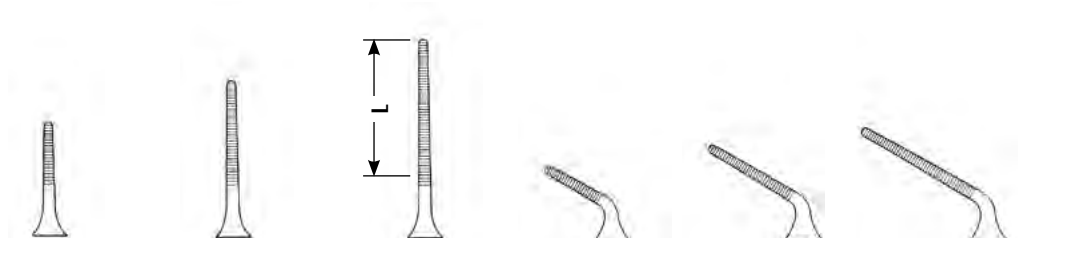

1154-9808

1154-9812

1154-9820

1154-9908

1154-9912

1154-9920

DIETRICH

1154-9808	8 mm (L)
1154-9812	12 mm (L)
1154-9820	20 mm (L)
1154-9908	8 mm (L)
1154-9912	12 mm (L)
1154-9920	20 mm (L)

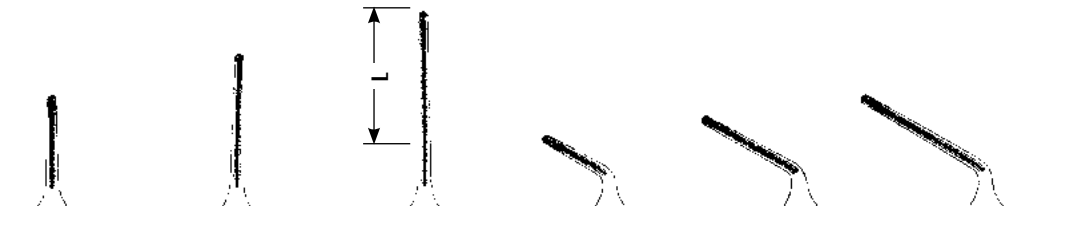

1155-0810

1155-0814

1155-0820

1155-0910

1155-0914

1155-0920

DEBAKEY-DIETRICH

1155-0810	10 mm (L)
1155-0814	14 mm (L)
1155-0820	20 mm (L)
1155-0910	10 mm (L)
1155-0914	14 mm (L)
1155-0920	20 mm (L)

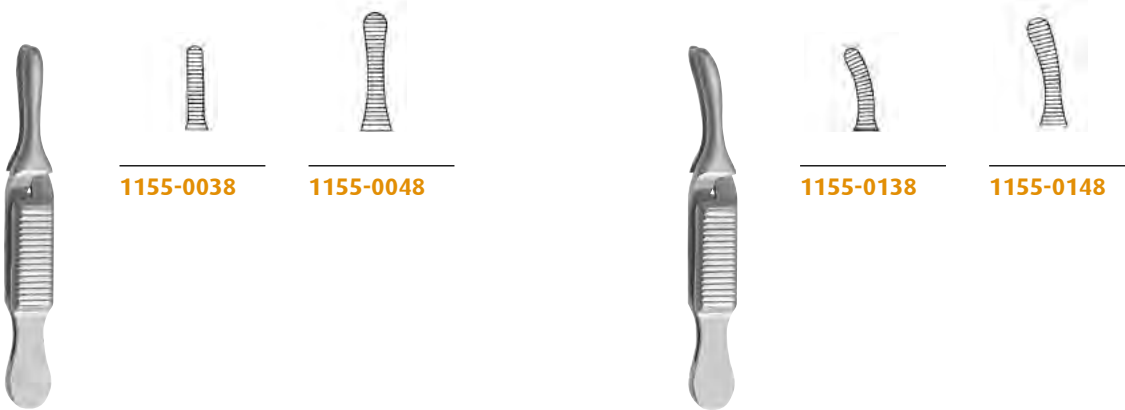

DIEFENBACH

- 1155-0038** 3,5 cm / 1 1/2"
- 1155-0048** 5,0 cm / 2"

DIEFENBACH

- 1155-0138** 3,5 cm / 1 1/2"
- 1155-0148** 5,0 cm / 2"

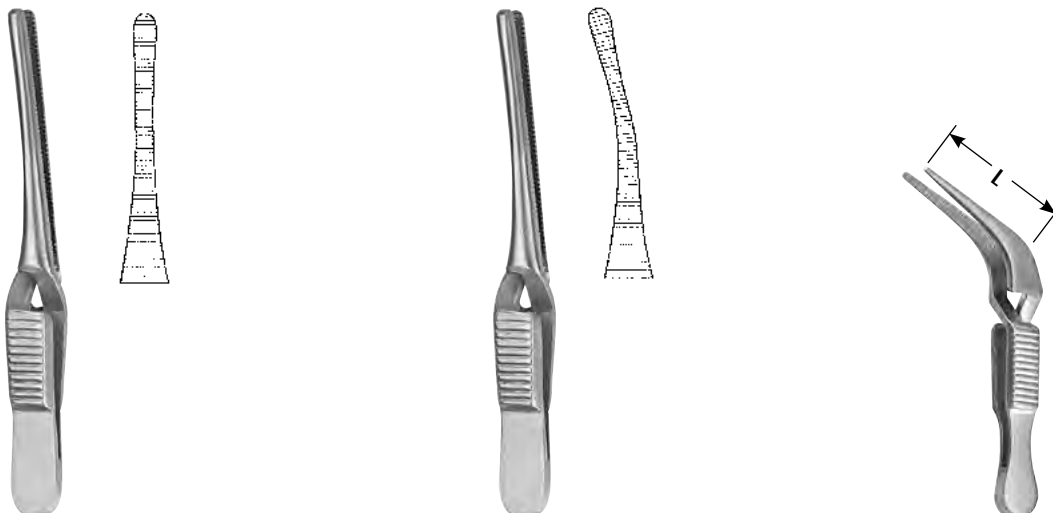

JOHNS-HOPKINS

- 1155-0650** 5,0 cm / 2"
- 1155-0665** 6,5 cm / 2 1/2"
- 1155-0675** 7,5 cm / 3"

JOHNS-HOPKINS

- 1155-0550** 5,0 cm / 2"
- 1155-0565** 6,5 cm / 2 1/2"
- 1155-0575** 7,5 cm / 3"

HESS

- 1154-9929** 20 mm
- 1154-9930** 30 mm



HALSTED-MOSQUITO

1150-6012 - 1151-6112
1150-6014 - 1151-6114

12,5 cm / 5"
14,0 cm / 5 1/2"



1150-6012



1150-6112

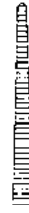

1150-6014



1150-6114



1151-6012



1151-6112



1151-6014

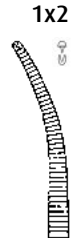

1151-6114



HALSTED-MOSQUITO

1150-2618 - 1151-2718
1150-2621 - 1151-2721

18,0 cm / 7"
21,0 cm / 8 1/4"



1150-2618

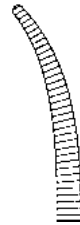

1150-2718



1150-2621

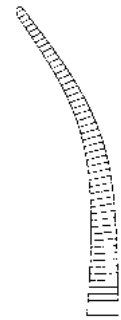

1150-2721



1151-2618



1151-2718

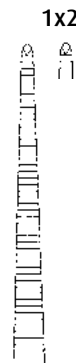

1151-2621

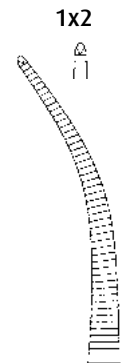

1151-2721



1150-6210



1150-6310



1150-6212



1150-6312

1x2



1151-6210

1x2



1151-6310

1x2



1151-6212

1x2



1151-6312

MICRO-MOSQUITO

1150-6210 - 1151-6310

10,0 cm / 4"

1150-6212 - 1151-6312

12,0 cm / 4³/₄"



1150-6410



1150-6510

HARTMANN

1150-6410 - 1150-6510

10,0 cm / 4"

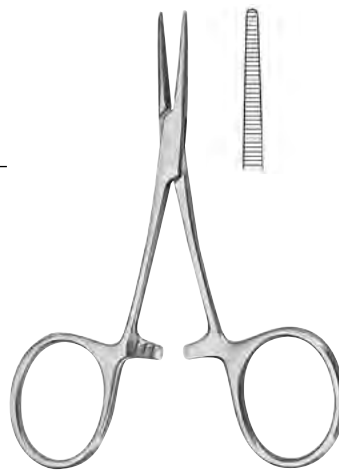

CARREL

1150-6608

8,5 cm / 3¹/₃"



1x2

TERRIER

1151-6608

8,5 cm / 3¹/₃"



KROENLEIN
1150-7213

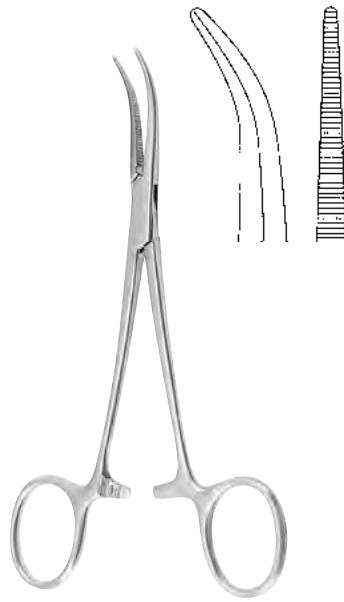

MOSQUITO-DANDY
1150-5112 12,0 cm / 4³/₄"

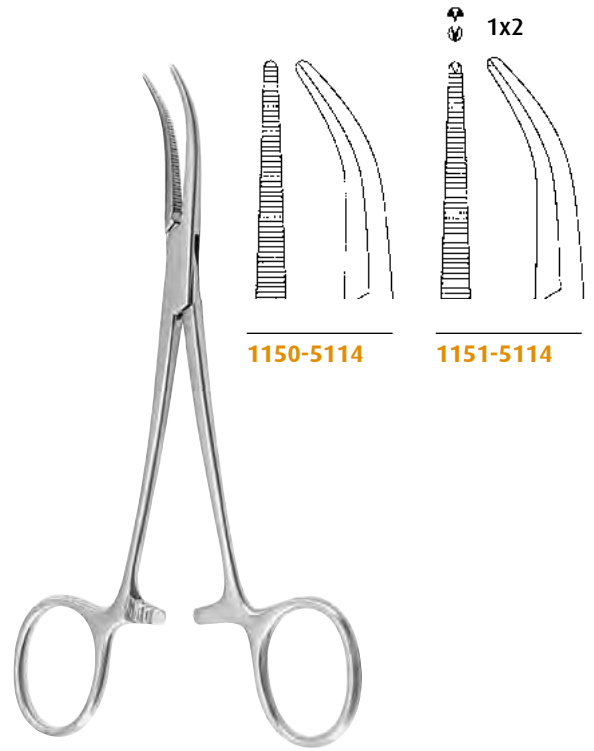

DANDY
1150-5114 - 1151-5114 14,0 cm / 5¹/₂"



PROVIDENCE-HOSPITAL
1151-5114 - 1150-5514 14,0 cm / 5¹/₂"

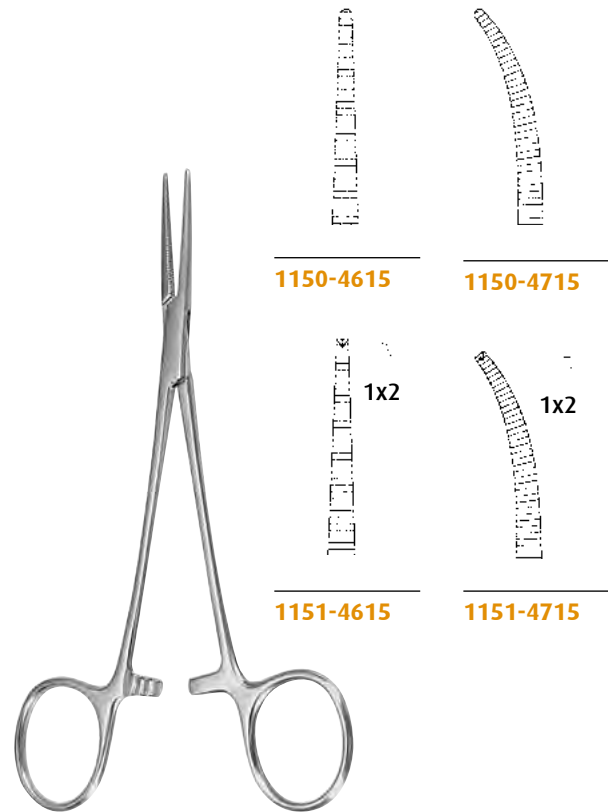

LERICHE
1150-4615 - 1151-4715 15,0 cm / 6"

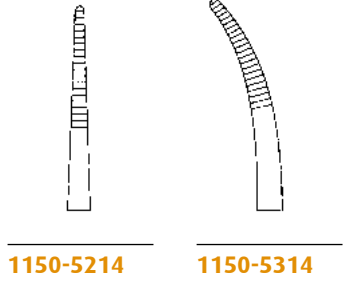

1150-5214

1150-5314

KELLY

1150-5214 - 1150-5314 14,0 cm / 5 1/2"

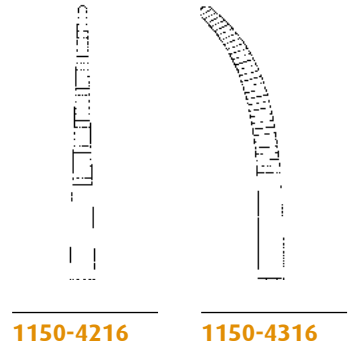

1150-4216

1150-4316

KELLY-RANKIN

1150-4216 - 1150-4316 16,0 cm / 6 1/4"

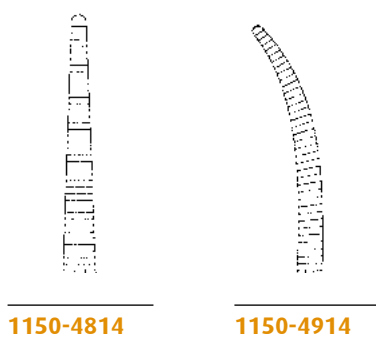

1150-4814

1150-4914

1x2

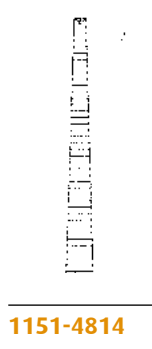

1151-4814

1x2

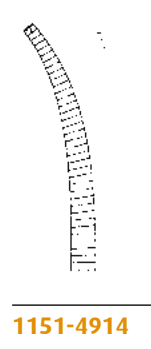

1151-4914

CRILE

1150-4814 - 1151-4914 14,0 cm / 5 1/2"

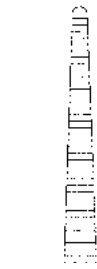

1150-3816



1150-3916

1x2



1151-3816

1x2

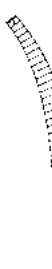

1151-3916

CRILE-RANKIN

1150-3816 - 1151-3916 16,0 cm / 6 1/4"

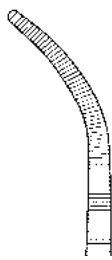

BABY-OVERHOLT

1152-7913 13,5 cm / 5 1/4"

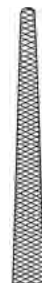
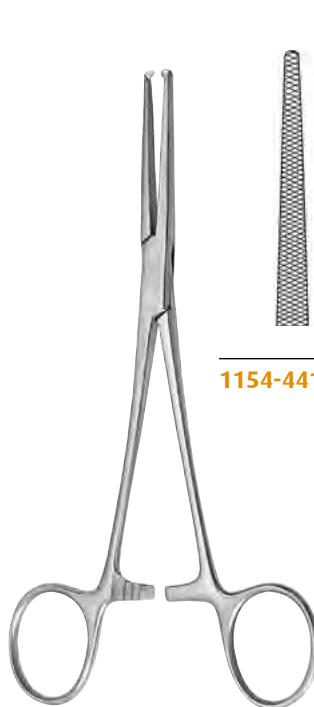

1154-4415

1x2



1151-4415

DIXON-LOVELACE

1154-4415 - 1151-4415 15,0 cm / 6"



1150-1413



1150-1415



1150-1418



1150-1420



1150-1423

SPENCER-WELLS

1150-1413	13,0 cm / 5 ¹ / ₈ "
1150-1415	15,0 cm / 6" ¹ / ₈ "
1150-1418	18,0 cm / 7"
1150-1420	20,0 cm / 8"
1150-1423	23,0 cm / 9"

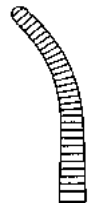

1150-1513

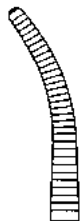

1150-1515

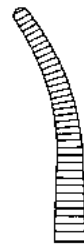

1150-1518

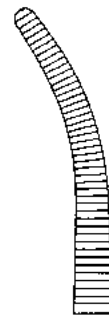

1150-1520

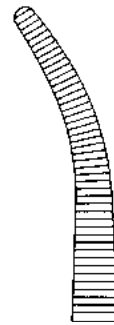

1150-1523

SPENCER-WELLS

1150-1513	13,0 cm / 5 ¹ / ₈ "
1150-1515	15,0 cm / 6" ¹ / ₈ "
1150-1518	18,0 cm / 7"
1150-1520	20,0 cm / 8"
1150-1523	23,0 cm / 9"

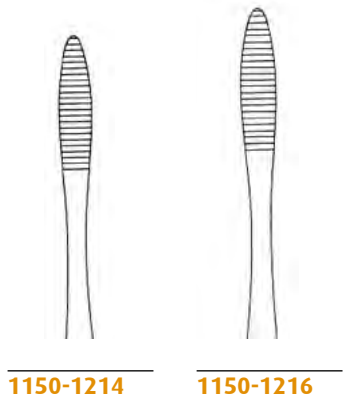

PEAN

- 1150-1214 14,0 cm / 5 1/2"
- 1150-1216 16,0 cm / 6 1/4"

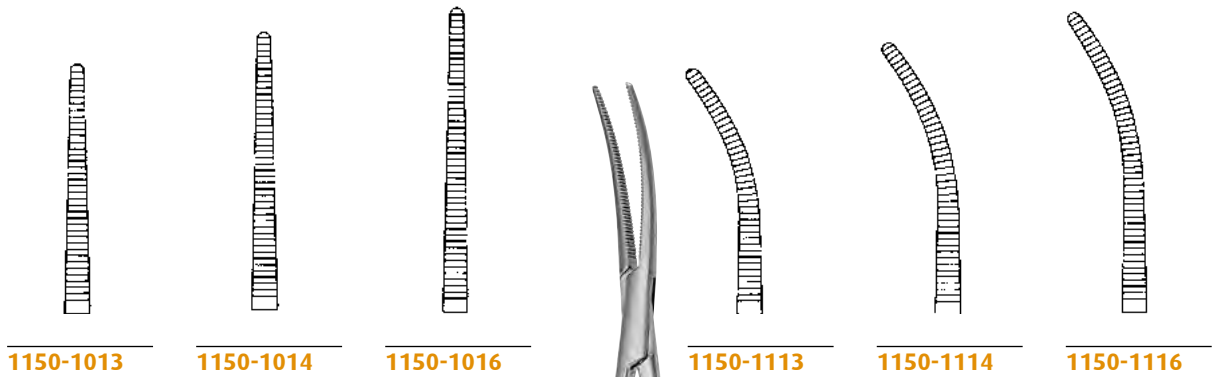
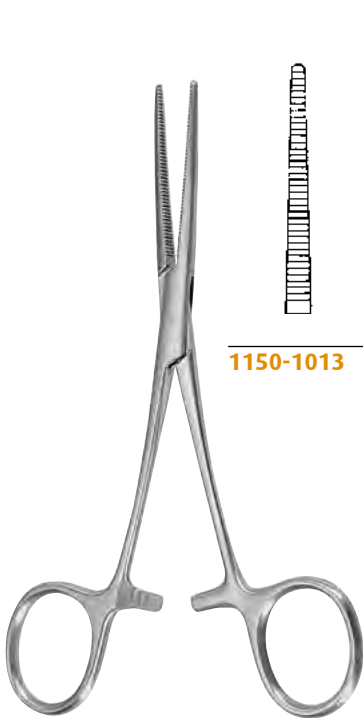

PEAN-DELICATE

- 1150-1013 13,0 cm / 5 1/8"
- 1150-1014 14,0 cm / 5 1/2"
- 1150-1016 16,0 cm / 6 1/4"

PEAN-DELICATE

- 1150-1113 13,0 cm / 5 1/8"
- 1150-1114 14,0 cm / 5 1/2"
- 1150-1116 16,0 cm / 6 1/4"



1150-0014



1150-0016



1150-0018



1150-0020

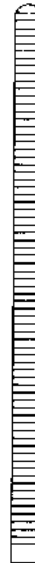

1150-0022

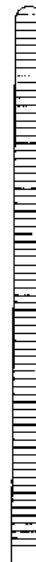

1150-0224

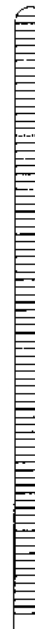

1150-0026

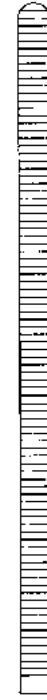

1150-0028

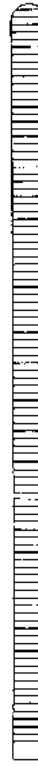

1150-0030

ROCHESTER-PEAN

1150-0014	14,0 cm / 5 1/2"
1150-0016	16,0 cm / 6 1/4"
1150-0018	18,0 cm / 7"
1150-0020	20,0 cm / 8"
1150-0022	22,0 cm / 8 3/4"
1150-0224	24,0 cm / 9 1/2"
1150-0026	26,0 cm / 10 1/4"
1150-0028	28,0 cm / 11"
1150-0030	30,0 cm / 11 3/4"

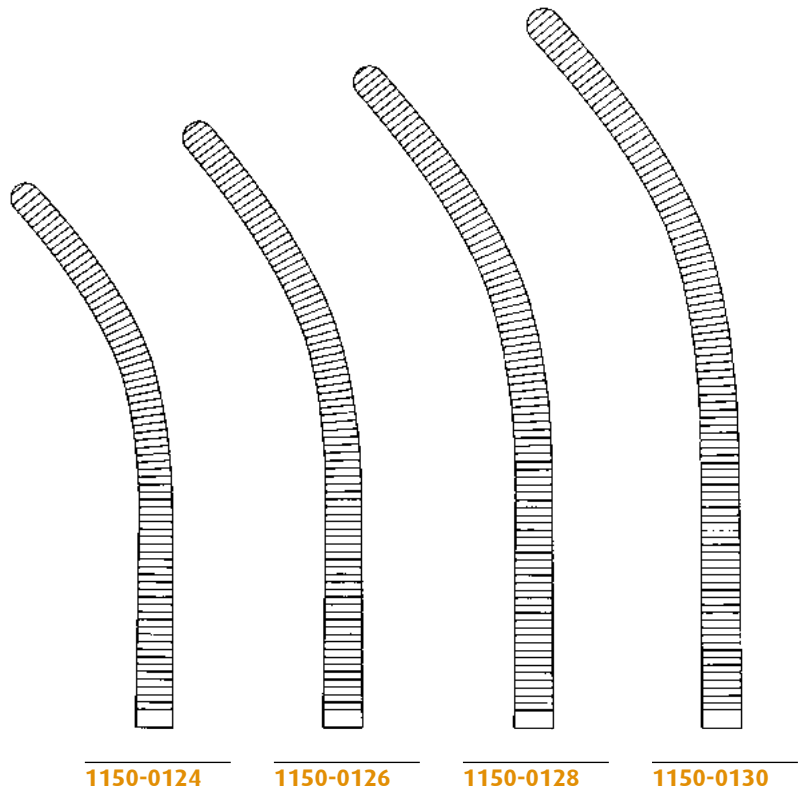
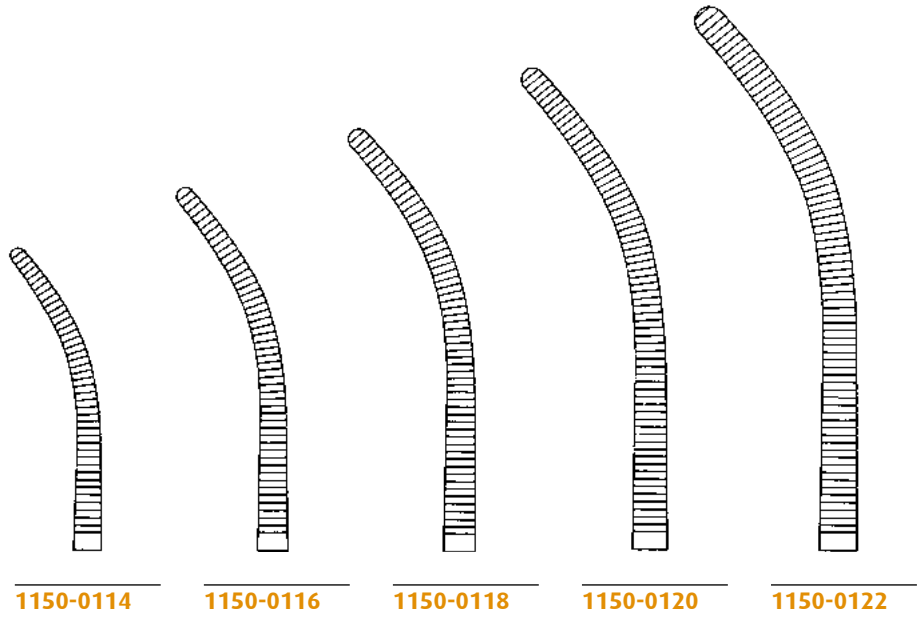

ROCHESTER-PEAN

1150-0114	14,0 cm / 5 ¹ / ₂ "
1150-0116	16,0 cm / 6 ¹ / ₄ "
1150-0118	18,0 cm / 7"
1150-0120	20,0 cm / 8"
1150-0122	22,0 cm / 8 ³ / ₄ "
1150-0124	24,0 cm / 9 ¹ / ₂ "
1150-0126	26,0 cm / 10 ¹ / ₄ "
1150-0128	28,0 cm / 11"
1150-0130	30,0 cm / 11 ³ / ₄ "



KOCHER

1151-0214 14,5 cm / 5³/₄"

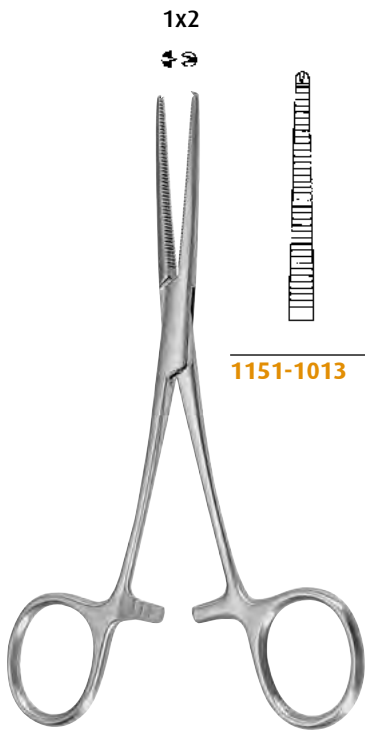

1151-1013

1151-1014

015-270-160

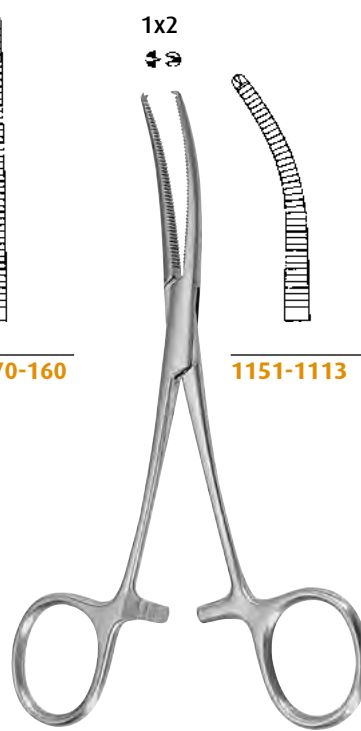

1151-1113

1151-1114

1151-1116

KOCHER DELICATE

1151-1013 13,0 cm / 5¹/₈"
1151-1014 14,0 cm / 5¹/₂"
1151-1016 16,0 cm / 6¹/₄"

KOCHER DELICATE

1151-1113 13,0 cm / 5¹/₈"
1151-1114 14,0 cm / 5¹/₂"
1151-1116 16,0 cm / 6¹/₄"



1151-0013



1151-0014

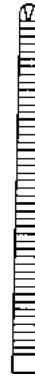

1151-0016



1151-0018

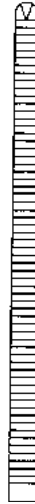

1151-0020



1151-0022

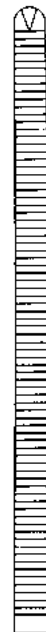

1151-0024

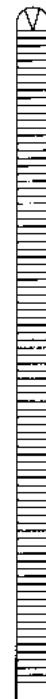

1151-0026

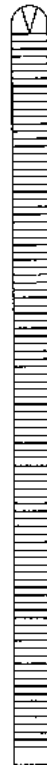

1151-0030

KOCHER-OCHSNER

1151-0013	13,0 cm / 5 ¹ / ₈ "
1151-0014	14,0 cm / 5 ¹ / ₂ "
1151-0016	16,0 cm / 6 ¹ / ₄ "
1151-0018	18,0 cm / 7"
1151-0020	20,0 cm / 8"
1151-0022	22,0 cm / 8 ³ / ₄ "
1151-0024	24,0 cm / 9 ¹ / ₂ "
1151-0026	26,0 cm / 10 ¹ / ₄ "
1151-0030	30,0 cm / 11 ³ / ₄ "

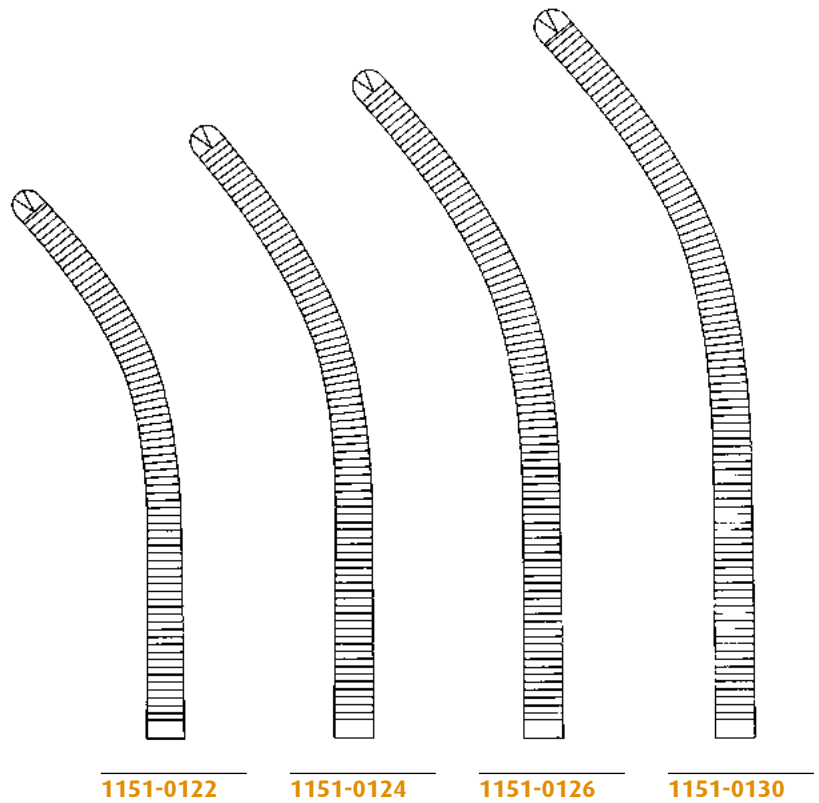
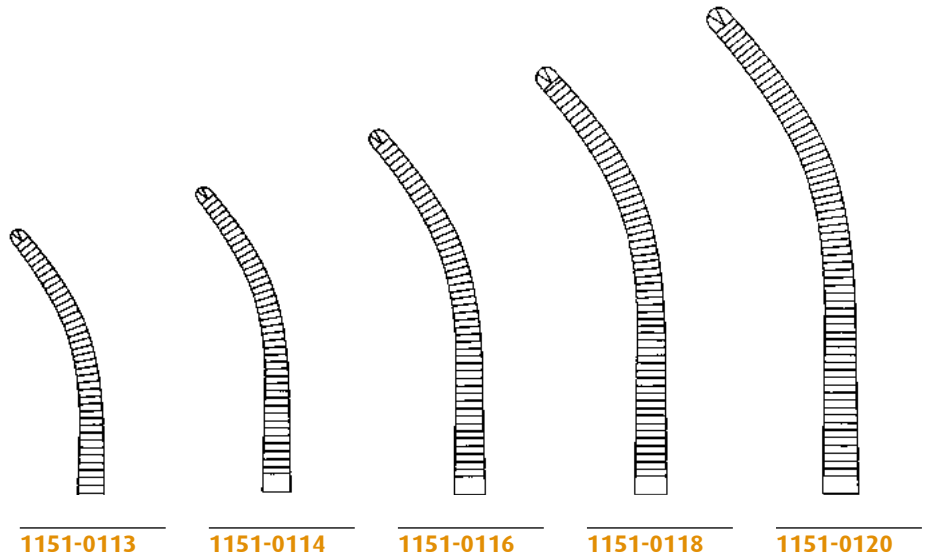

KOCHER-OCHSNER

1151-0113	13,0 cm / 5 ¹ / ₈ "
1151-0114	14,0 cm / 5 ¹ / ₂ "
1151-0116	16,0 cm / 6 ¹ / ₄ "
1151-0118	18,0 cm / 7"
1151-0120	20,0 cm / 8"
1151-0122	22,0 cm / 8 ³ / ₄ "
1151-0124	24,0 cm / 9 ¹ / ₂ "
1151-0126	26,0 cm / 10 ¹ / ₄ "
1151-0130	30,0 cm / 11 ³ / ₄ "

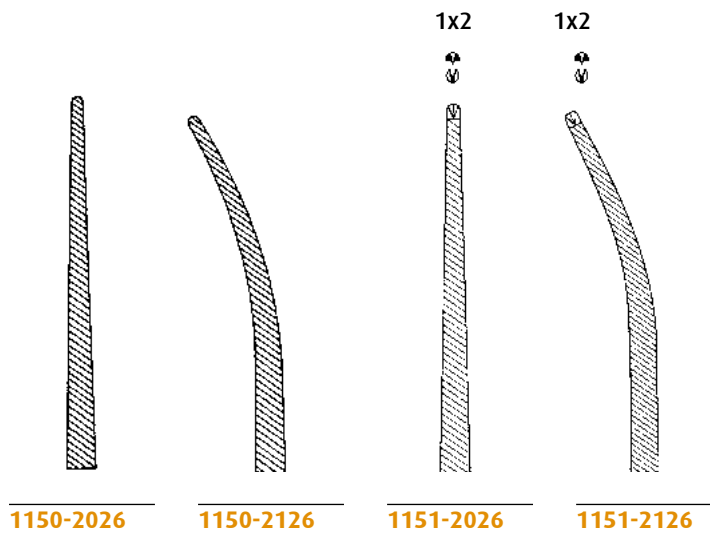
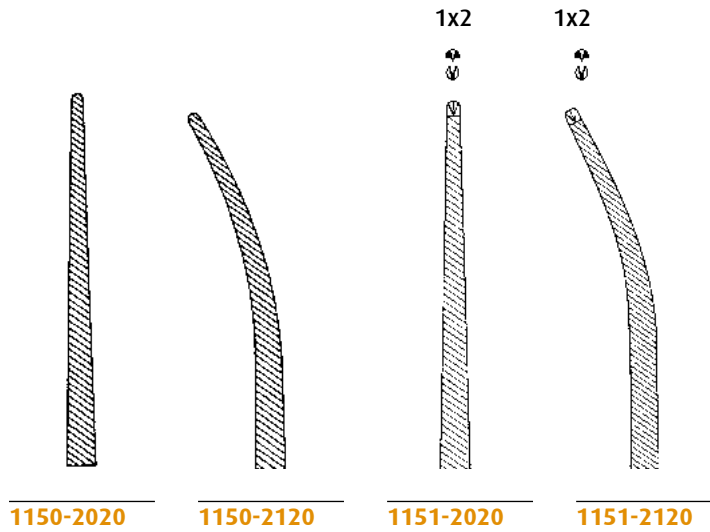

BENGOLEA

1150-2020 – 1151-2120 20,0 cm / 8"
 1150-2026 – 1151-2126 26,0 cm / 10¹/₄"



CHAPUT

1157-8013 13,0 cm / 5 1/8"



TUFFIER

1157-7813 13,0 cm / 5 1/8"



PENNINGTON

1157-5615 15,5 cm / 6 1/8"
1157-5620 20,0 cm / 8"

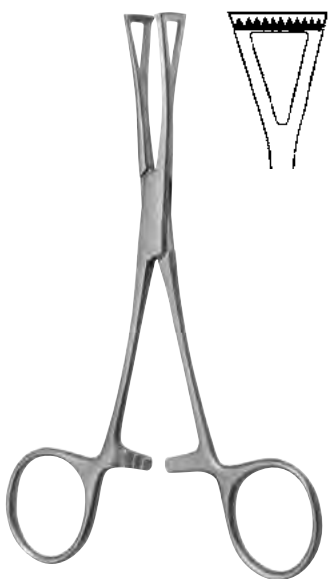

COLLIN

1157-5414 14,0 cm / 5 1/2"



COLLIN

1157-3416 - 1157-3417 16,0 cm / 6 1/4"

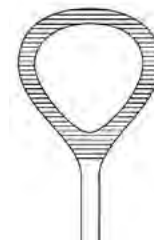

1157-3416



1157-3417

Druckklemmen, Hämorrhoidenklemmen
Pressure Clamps, Haemorrhoidal Clamps
Pinza-Clamp de presión progresiva, Pinza-Clamps para hemorroides
Clamps a pressione, Pinze per emorroidi

015



BUIE
1153-3721 21,0 cm / 8¹/₄"



PRATT
1153-3815 15,0 cm / 6"



MARTEL
1157-8614 14,0 cm / 5¹/₂"

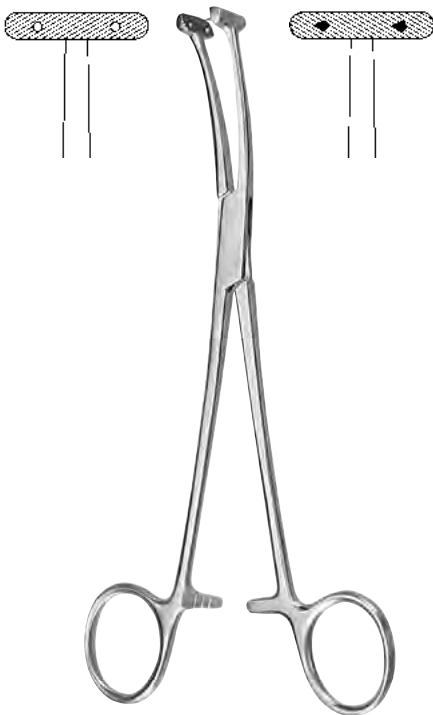

WILLET-MARTEL
1357-3419 19,0 cm / 7¹/₂"

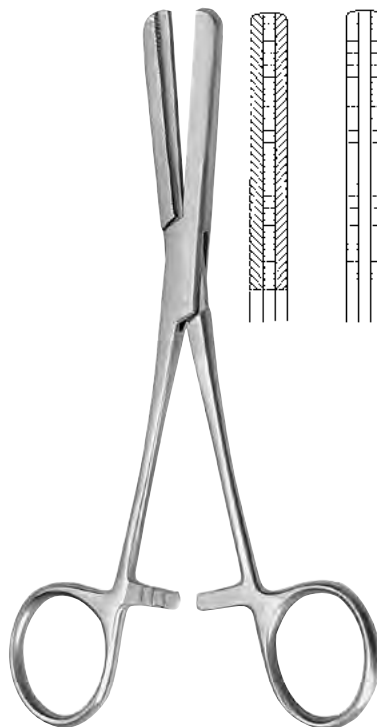

FERGUSON
1331-5525 16,0 cm / 6¹/₄"
1331-5625 20,0 cm / 8"

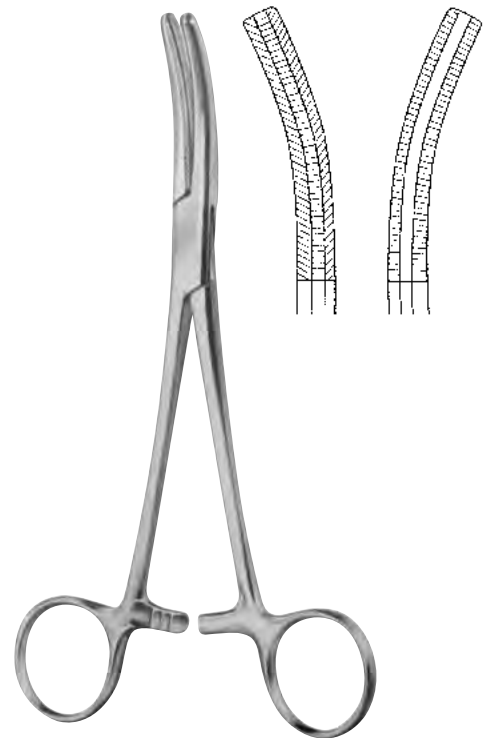

FERGUSON
1331-5526 16,0 cm / 6¹/₄"
1331-5626 20,0 cm / 8"

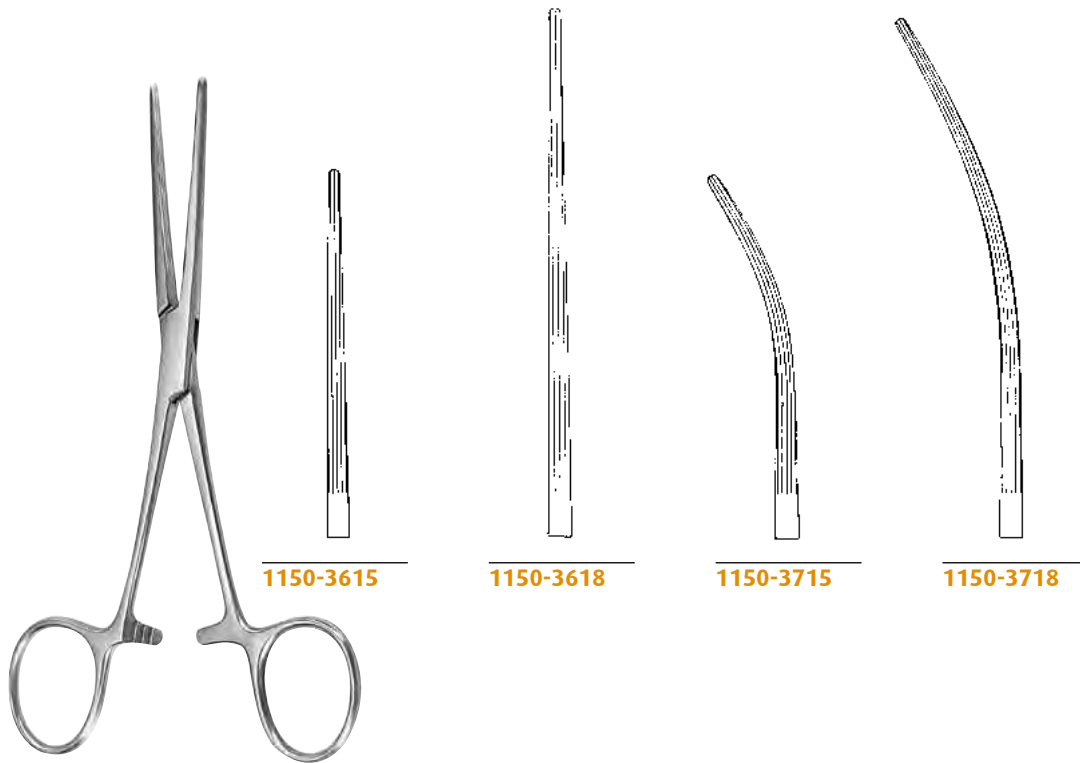

1150-3615

1150-3618

1150-3715

1150-3718

BAINBRIDGE

1150-3615 – 1150-3715

15,0 cm / 6"

1150-3618 – 1150-3718

18,5 cm / 7¹/₄"

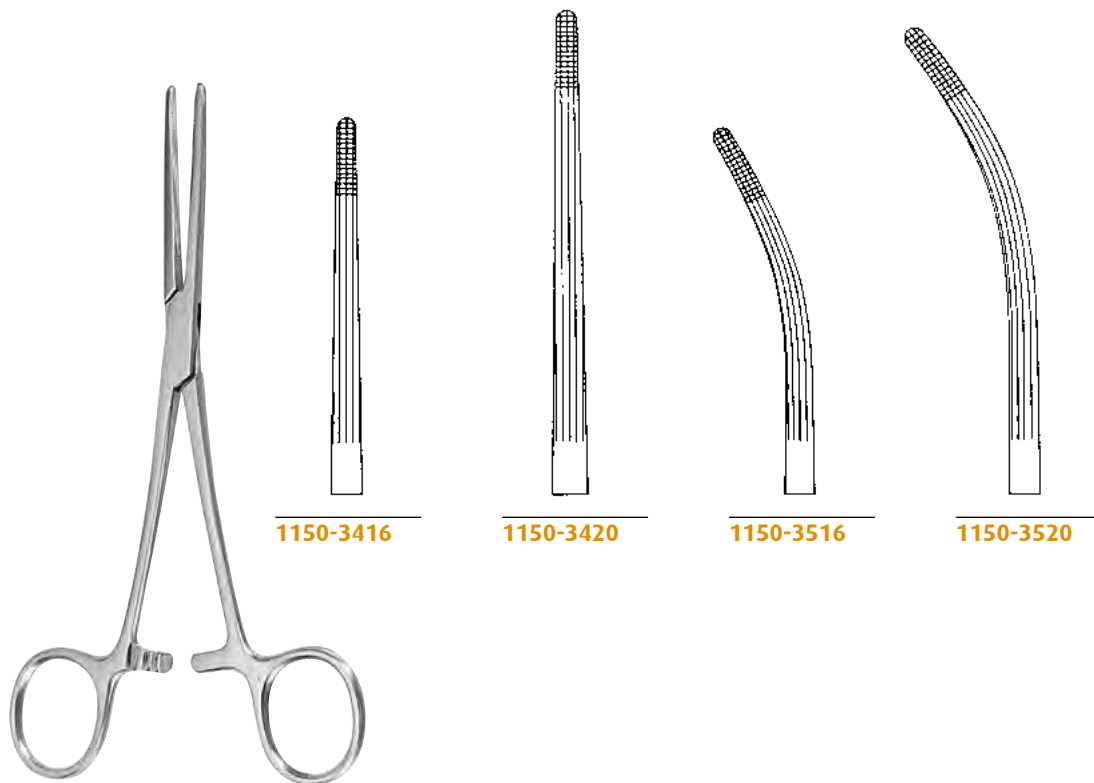

1150-3416

1150-3420

1150-3516

1150-3520

ROCHESTER-CARMALT

1150-3416 – 1150-3516

16,0 cm / 6¹/₄"

1150-3420 – 1150-3520

20,0 cm / 8"



BABY-MIXTER

1152-7501 - 1152-7502

14,0 cm / 5 1/2"



BABY-MIXTER

1152-6518 18,0 cm / 7"

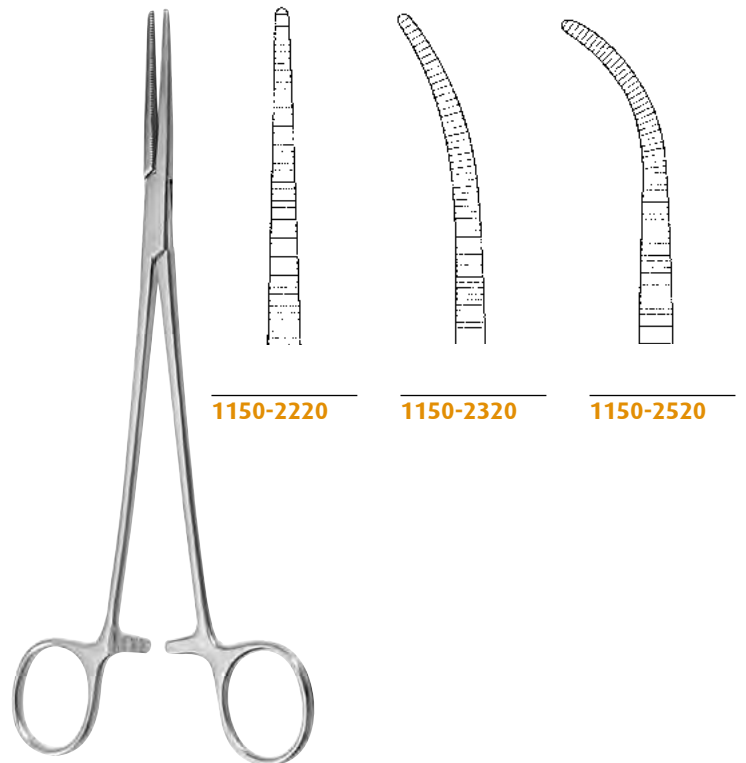

HEISS

1150-2220 - 1150-2520

20,0 cm / 8"

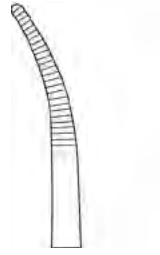

1150-2919

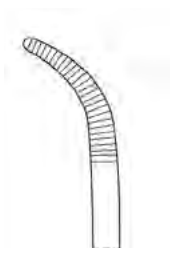

1150-2918

SCHNIDT

1150-2919- 1150-2918

19,0 cm / 7 1/2"



1150-3018

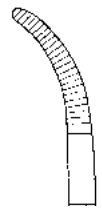

1150-3119

ADSON

1150-3018 - 1150-3119

18,5 cm / 7 1/4"

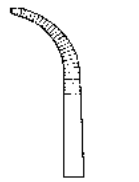

1152-7314

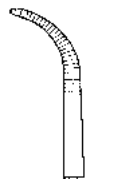

1152-7318

BABY-ADSON

1152-7314 14,0 cm / 5 1/2"
 1152-7318 18,0 cm / 7"



MIKRO-ADSON

1150-3314 14,0 cm / 5 1/2"

Arterienklemmen
 Haemostatic Forceps
 Pinzas hemostáticas
 Pinze emostatiche

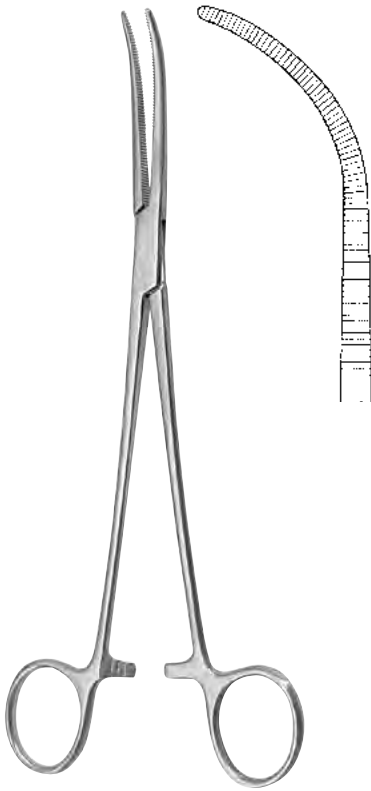

OVERHOLT-MIXTER

1152-6121 21,0 cm / 8¹/₄"



1150-5618

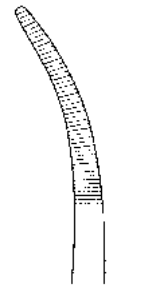

1150-5718

BIRKETT

1150-5618 - 1150-5718

19,0 cm / 7¹/₂"



JOHNS HOPKINS

1153-6320 20,0 cm / 8"



1152-6622

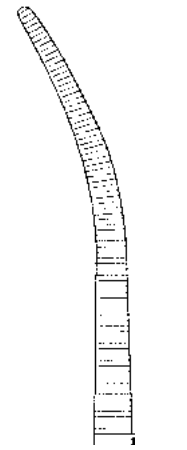

1152-6722

ROBERTS

1152-6622 - 1152-6722

22,0 cm / 8³/₄"

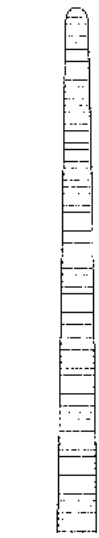

1152-4824

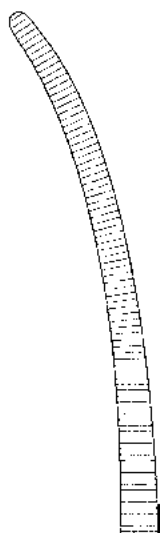

1152-4924

SAROT

1152-4824 – 1152-4924

24,0 cm / 9 1/2"



CRAFOORD

1152-4524

24,0 cm / 9 1/2"

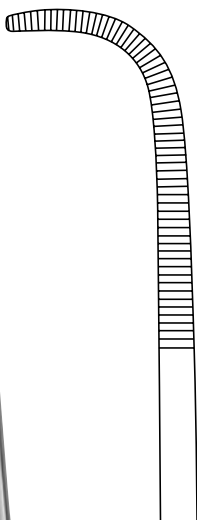
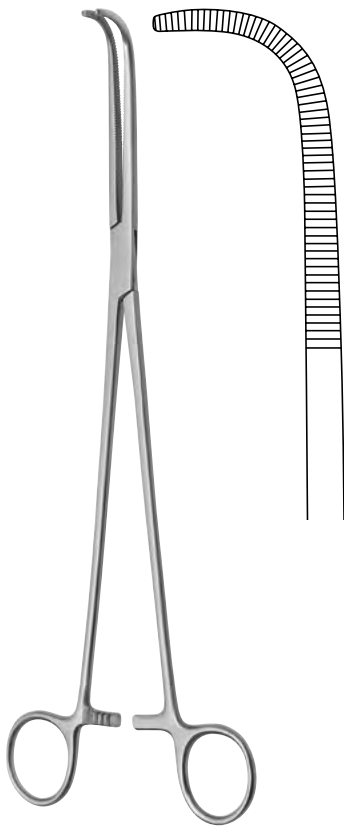

MIXTER-CRAFOORD

1152-7127 27,0 cm / 10 3/4"

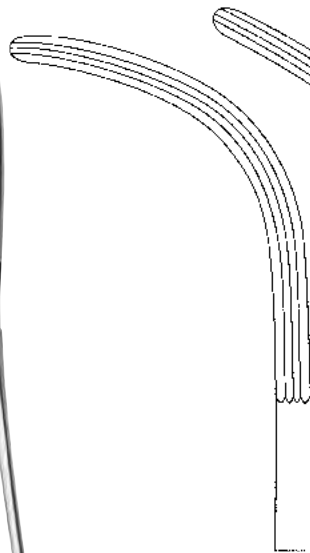

1152-4720



1152-4730

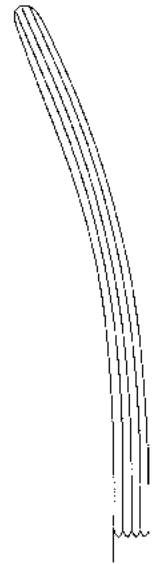

1152-4724

CRAFOORD-SELLORS

1152-4720 22,0 cm / 8 3/4"

1152-4730 23,0 cm / 9"

1152-4724 24,0 cm / 9 1/2"

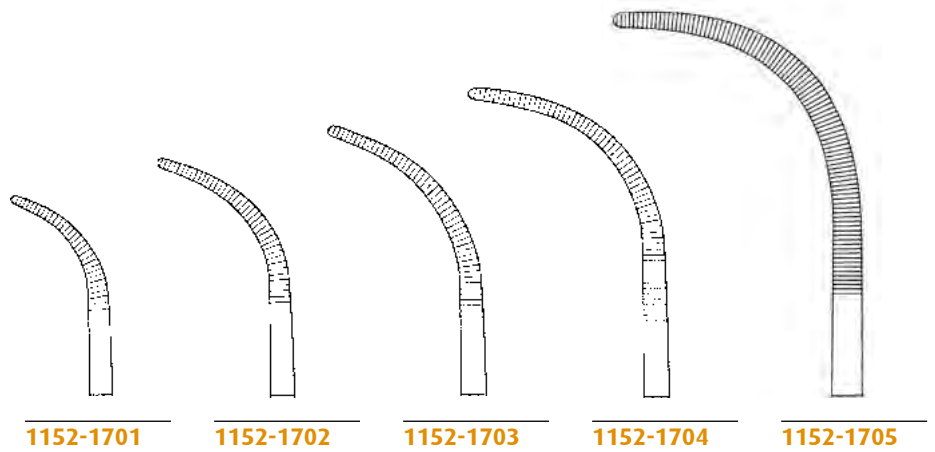
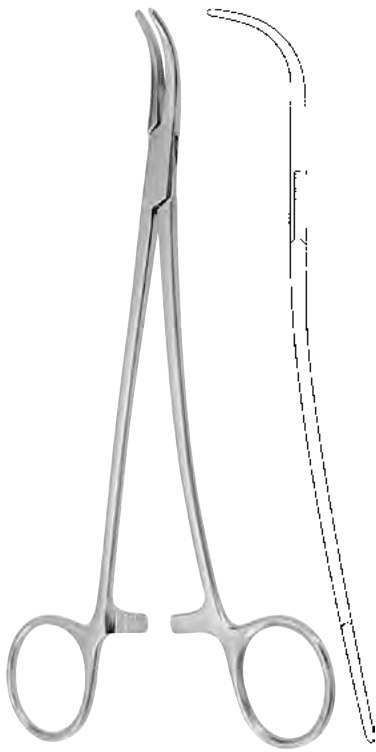

OVERHOLT

1152-1701	18,5 cm / 7 ¹ / ₄ "
1152-1702	20,0 cm / 8"
1152-1703	21,0 cm / 8 ¹ / ₄ "
1152-1704	21,5 cm / 8 ¹ / ₂ "
1152-1705	24,0 cm / 9 ¹ / ₂ "

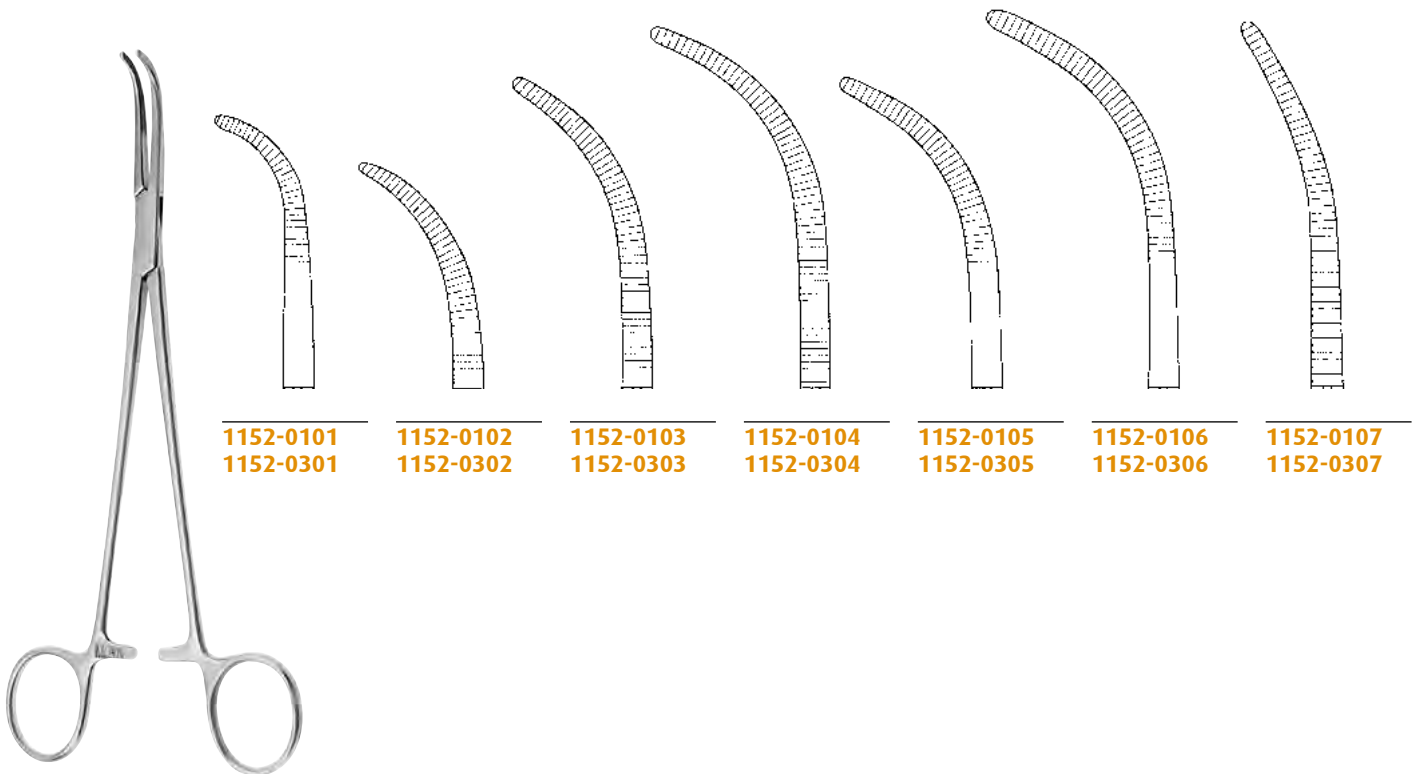

OVERHOLT-GEISSENDOERFER

1152-0101 - 1152-0107	21,0 cm / 8 ¹ / ₄ "
1152-0301 - 1152-0307	27,0 cm / 10 ³ / ₄ "

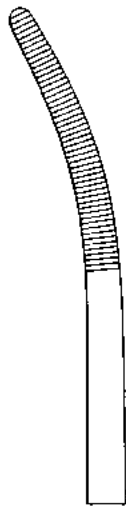
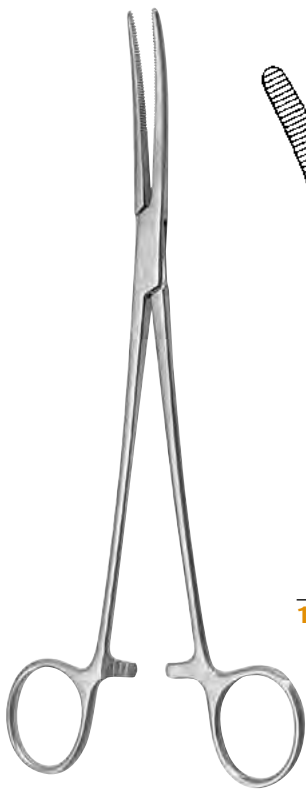

1152-5101

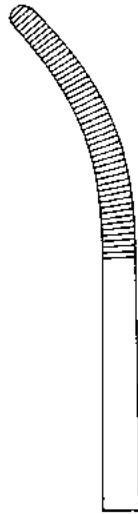

1152-5102

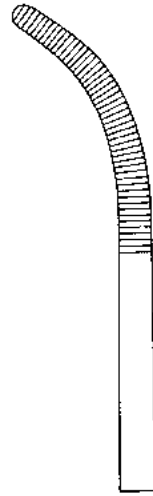

1152-5103

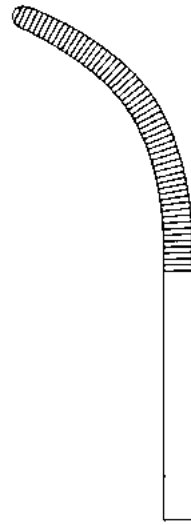

1152-5104

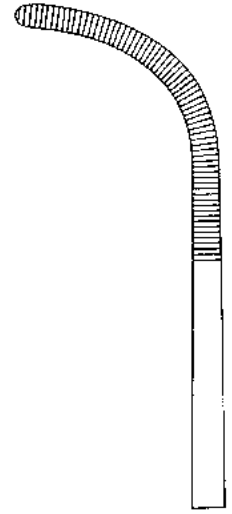

1152-5105

RUMEL

1152-5101 - 1152-5105

23,0 cm / 9"



1152-3918



1152-3922



1152-3925

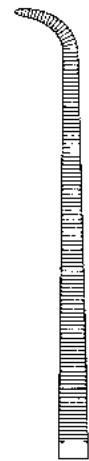

1152-3928

MINI-GEMINI

- 1152-3918 18,0 cm / 7"
- 1152-3922 22,0 cm / 8³/₄"
- 1152-3925 25,0 cm / 9³/₄"
- 1152-3928 28,0 cm / 11"

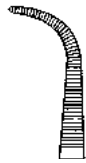

1152-3713

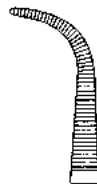

1152-3716



1152-3718



1152-3720

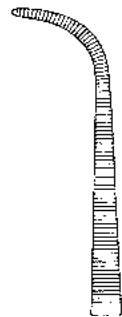

1152-3723

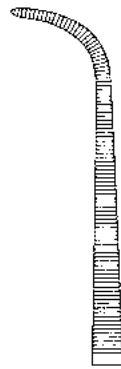

1152-3725

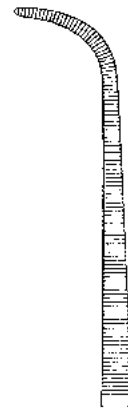

1152-3728



GEMINI

1152-3713	13,0 cm / 5 ¹ / ₈ "
1152-3716	16,0 cm / 6 ¹ / ₄ "
1152-3718	18,0 cm / 7"
1152-3720	20,0 cm / 8"
1152-3723	23,0 cm / 9"
1152-3725	25,0 cm / 9 ³ / ₄ "
1152-3728	28,0 cm / 11"

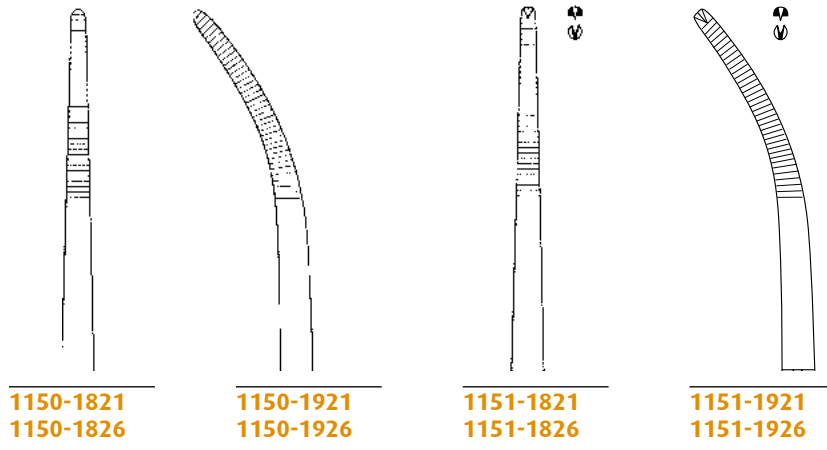

1150-1821
1150-1826

1150-1921
1150-1926

1151-1821
1151-1826

1151-1921
1151-1926

TOENNIS

1150-1821 – 1151-1921
1150-1826 – 1151-1926

21,0 cm / 8¹/₄"
26,0 cm / 10¹/₄"

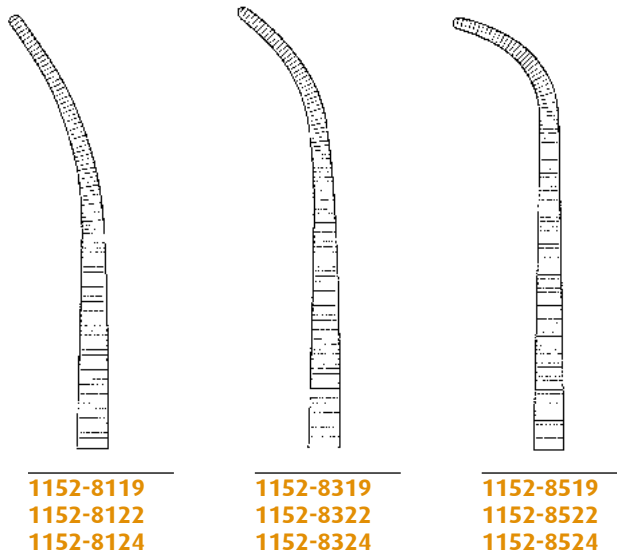

1152-8119
1152-8122
1152-8124

1152-8319
1152-8322
1152-8324

1152-8519
1152-8522
1152-8524

KELLY

1152-8119 – 1152-8124
1152-8319 – 1152-8324
1152-8519 – 1152-8524

19,0 cm / 7¹/₂"
22,0 cm / 8³/₄"
24,0 cm / 9¹/₂"



ZENKER

1152-3130 - 1152-3230

29,5 cm / 11⁵/₈"

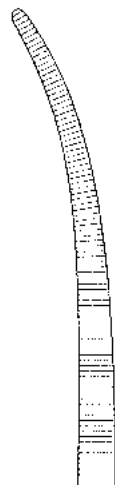

1152-3130

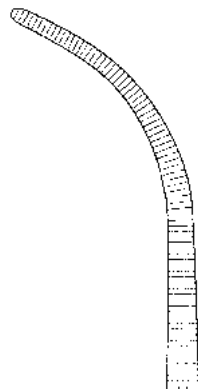

1152-3230

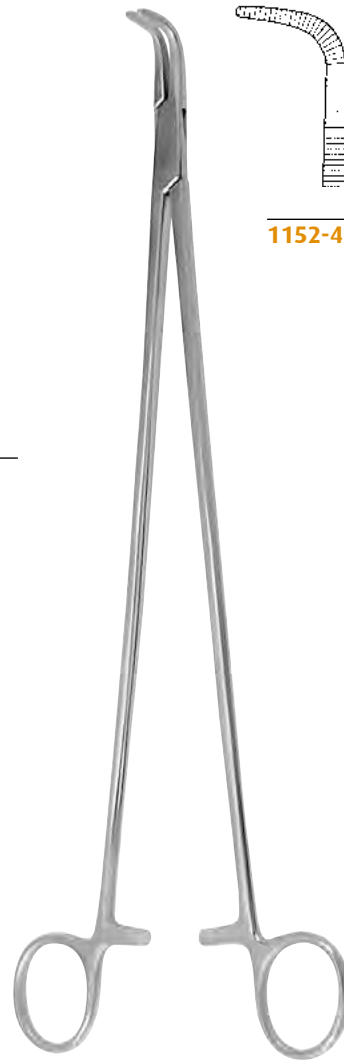

MEEKER

1152-4318

18,0 cm / 7"

1152-4328

27,5 cm / 10³/₄"

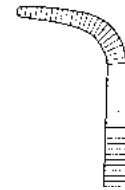

1152-4318

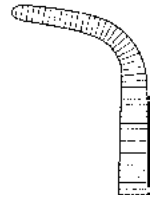

1152-4328

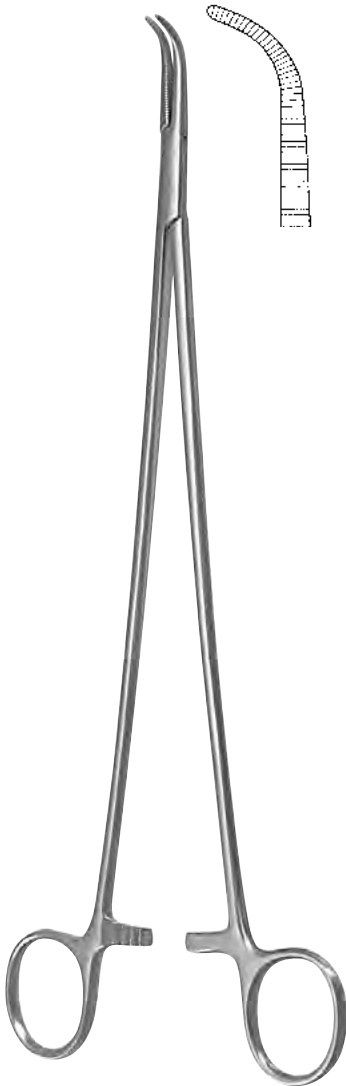
**LAWRENCE**

1152-3328 27,5 cm / 10³/₄"

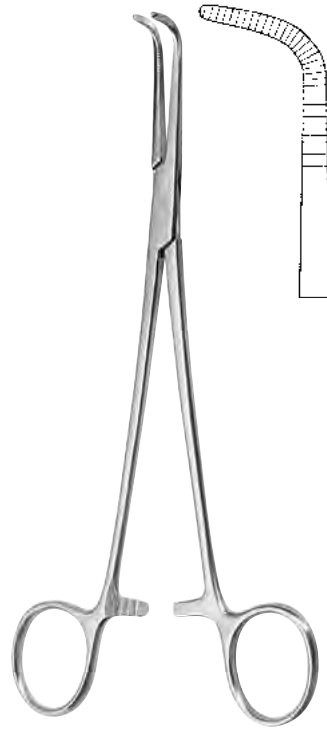
**KANTROWITZ**

1152-4120 19,0 cm / 7¹/₂"
1152-4124 24,0 cm / 9¹/₂"
1152-4128 26,5 cm / 10¹/₂"

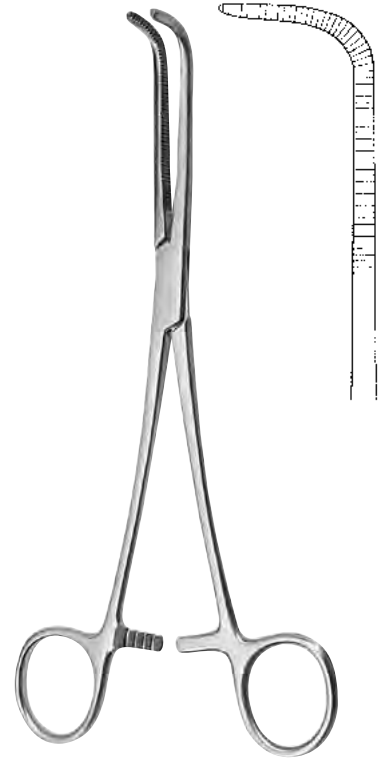
**WIRKSTROEM**

1152-7121 21,0 cm / 8¹/₄"
1152-7124 24,0 cm / 9¹/₂"

**MIXTER**

1152-6314 14,5 cm / 5³/₄"
1152-6315 15,5 cm / 6¹/₈"
1152-6319 19,0 cm / 7¹/₂"

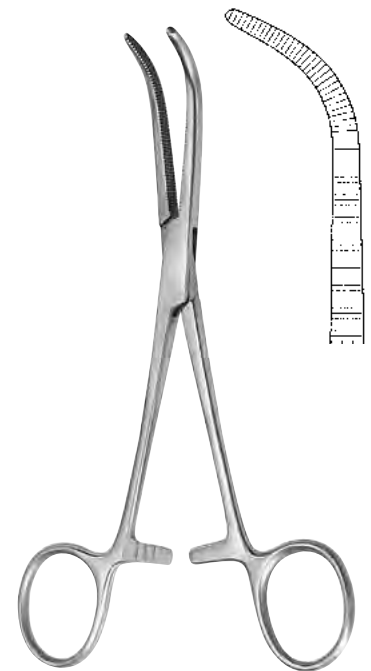
**MIXTER-O'SHAUGHNESSY**

1153-6815 15,5 cm / 6¹/₈"
1153-6820 19,0 cm / 7¹/₂"



MIXTER
1152-5922 22,0 cm / 8³/₄"

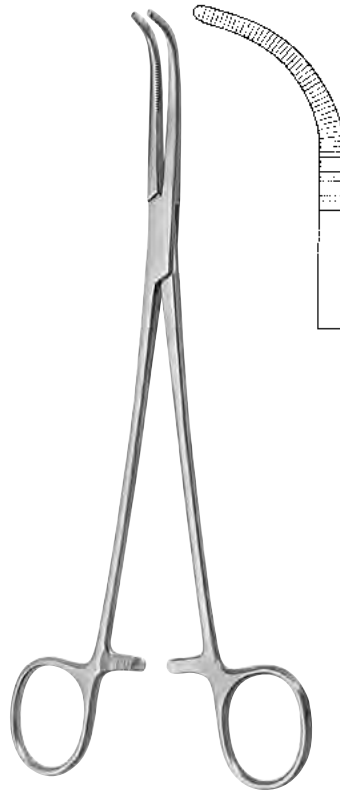

MIXTER
1152-5923 23,0 cm / 9"



DESJARDINS
1153-6921 21,0 cm / 8¹/₄"



NEGUS
1153-7118 - 1153-7119 19,0 cm / 7¹/₂"

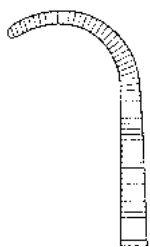

1153-7118

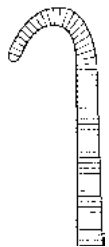

1153-7119

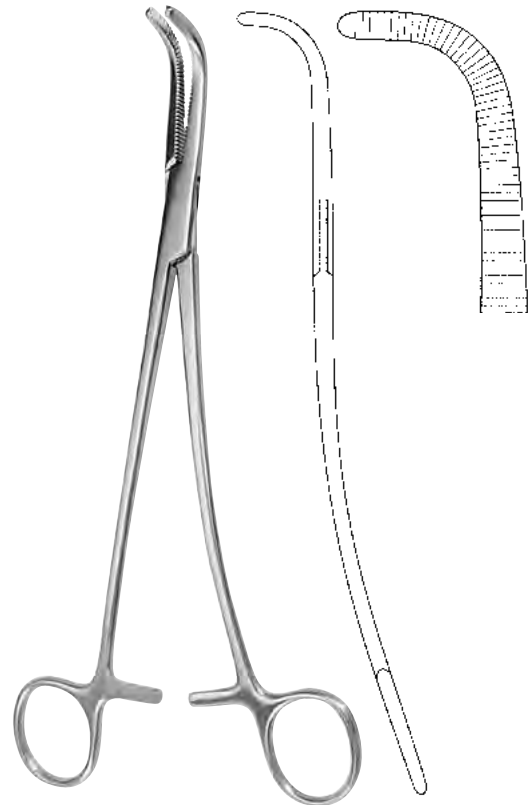

GRAY
1153-5922 22,0 cm / 8³/₄"
1153-5923 23,0 cm / 9"



1153-5522

1153-5525

1153-5528



LOWER

1153-6518 18,0 cm / 7"

MIXTER

1153-5522 22,0 cm / 8³/₄"
 1153-5525 25,0 cm / 9³/₄"
 1153-5528 28,0 cm / 11"

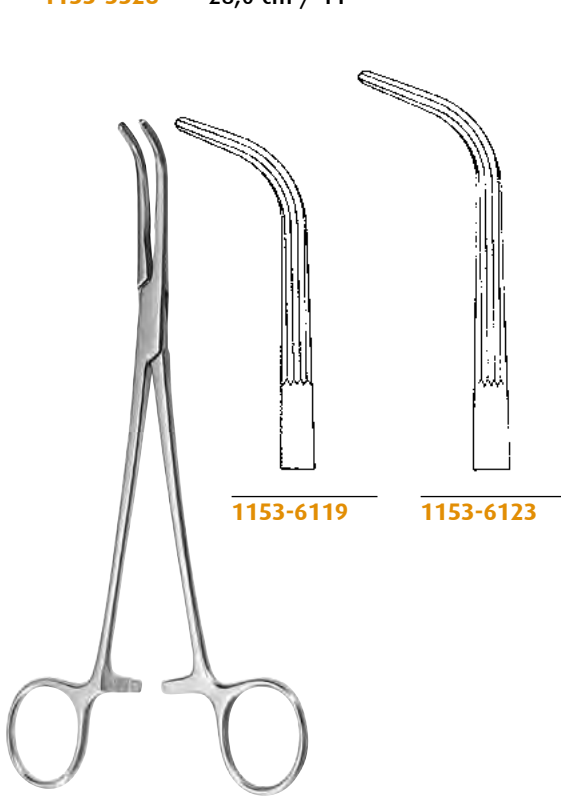

1153-6119

1153-6123

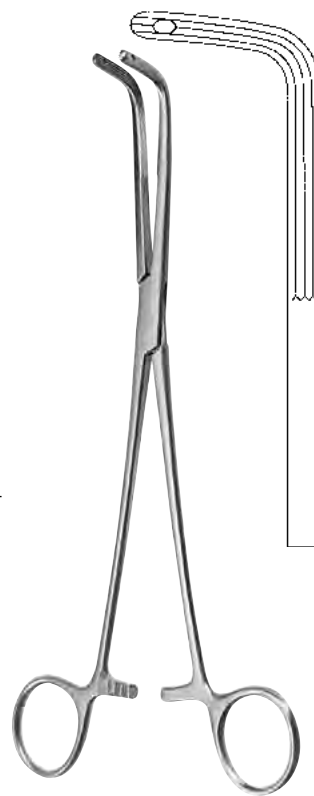

FINOCCHIETTO

1153-5724 24,0 cm / 9¹/₂"

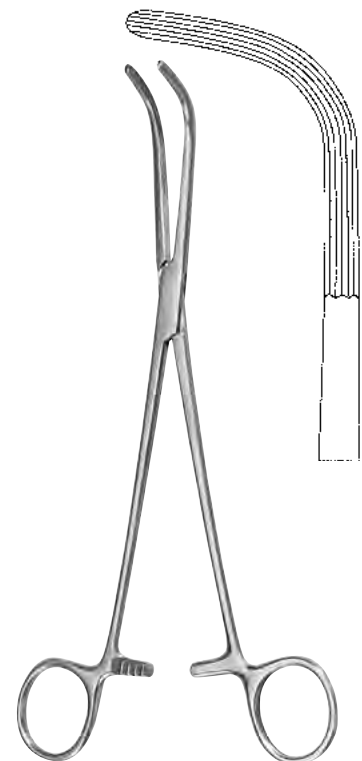

MC QUIGG-MIXTER

1153-5622 22,0 cm / 8³/₄"

LAHEY

1153-6119 19,0 cm / 7¹/₂"
 1153-6123 23,0 cm / 9"

Gallenkanal- und Nierenstielklemmen
Gall Duct and Kidney Pedicle Clamps
Pinzas-clamps para pedúnculo renal
Pinze per peduncoli renali

015

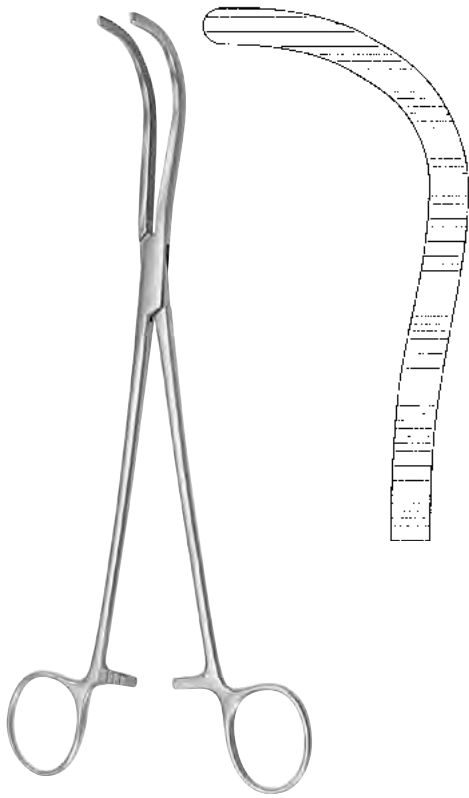

GUYON
1153-7523 23,0 cm / 12¹/₂"

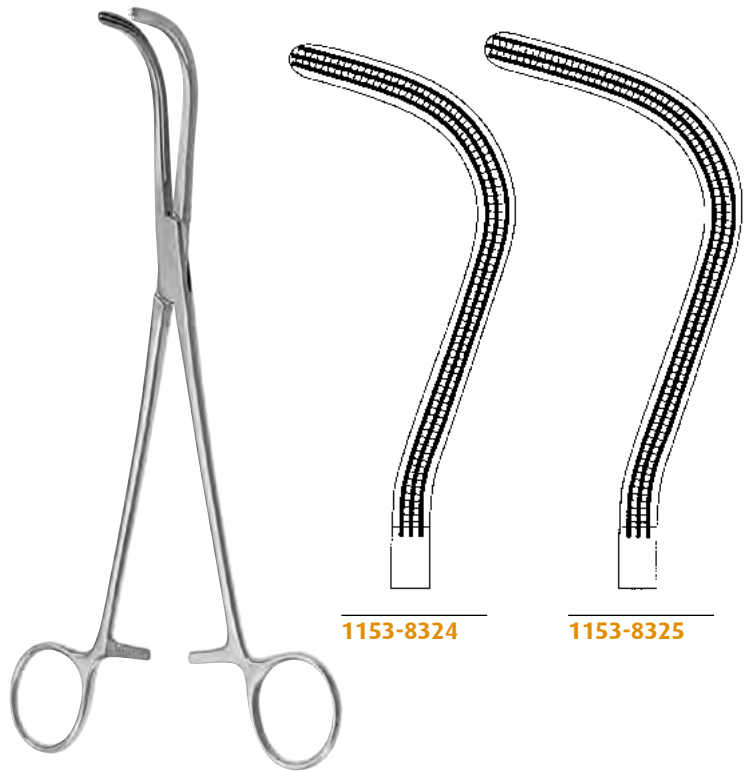

GUYON-ATRAUMA
1153-8324 - 1153-8325

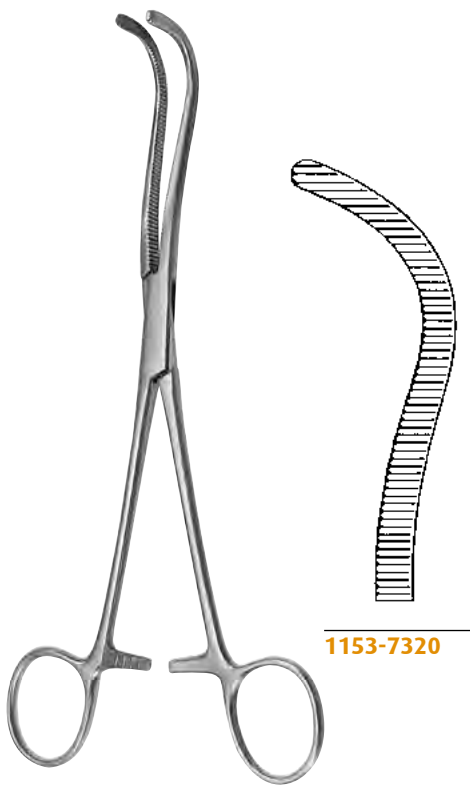

1153-7320

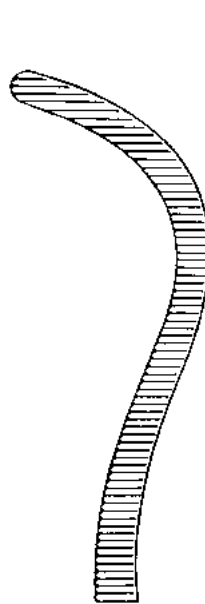

1153-7322

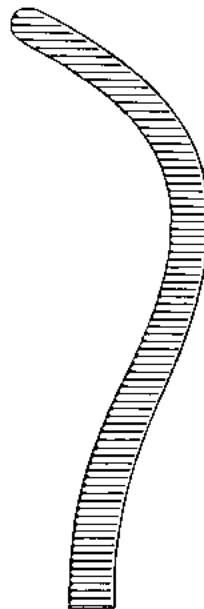

1153-7324

GUYON
1153-7320 20,0 cm / 8"
1153-7322 22,0 cm / 8³/₄"
1153-7324 24,0 cm / 9¹/₂"

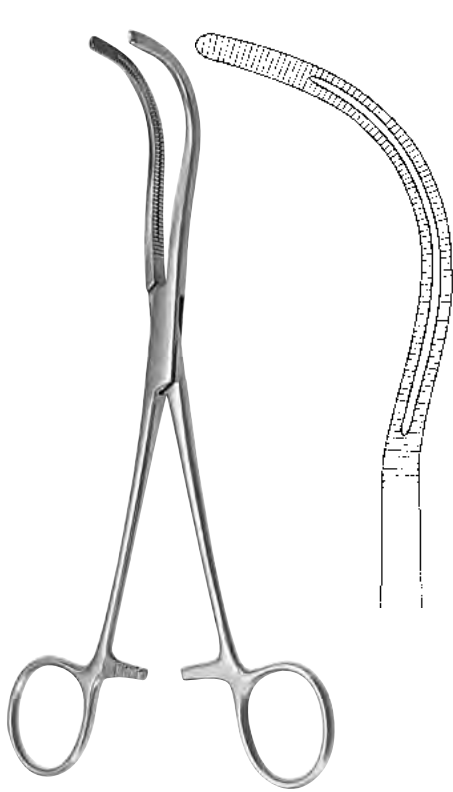

STILLE
 1153-8722 23,0 cm / 9"

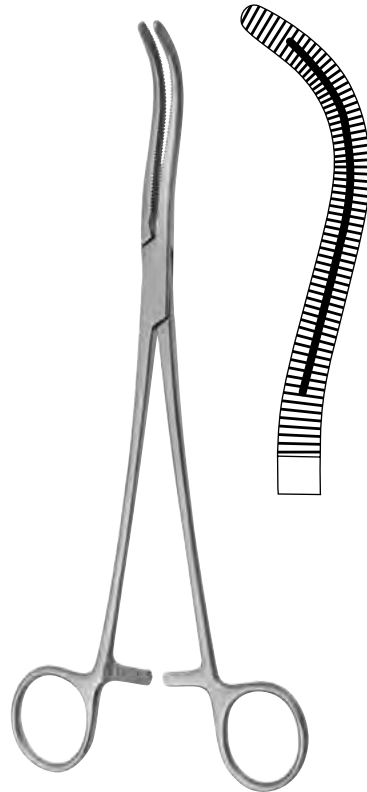

STILLE
 1153-7723 23,0 cm / 9"

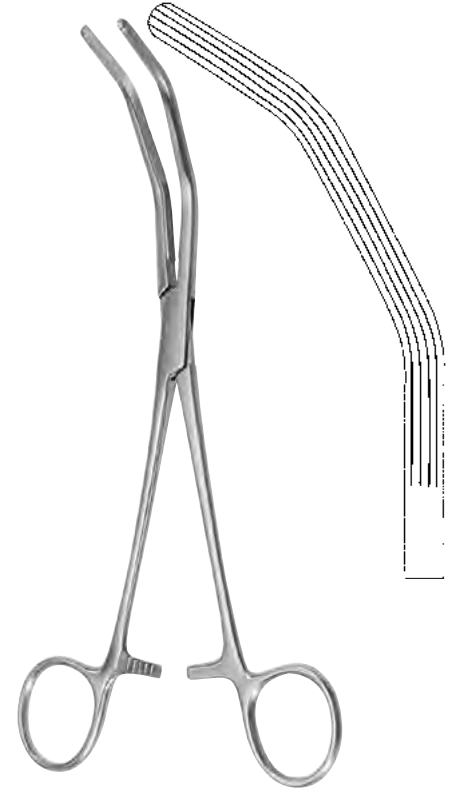

HERRICK
 1153-7923 23,0 cm / 9"

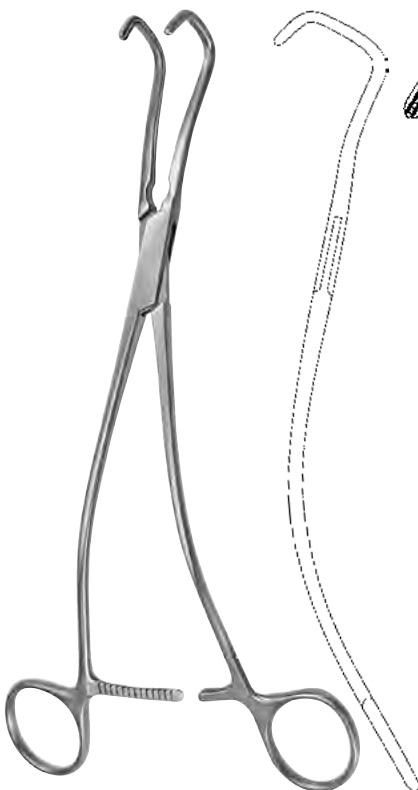

URO-TANGENTIAL
 1153-8023 23,0 cm / 9"
 1153-8024 24,0 cm / 9 1/2"

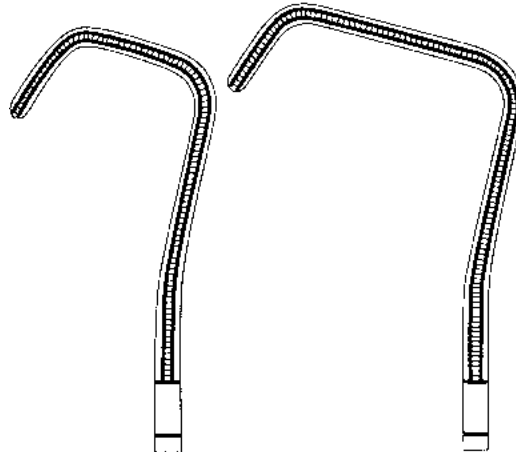

1153-8023

1153-8024

Peritoneumklemmen, Hysterektomieklemmen
Peritoneum Forceps, Hysterectomy Forceps
Pinzas-clamps para peritoneo y para histerectomia
Pinze per peritoneo e per isterectomia

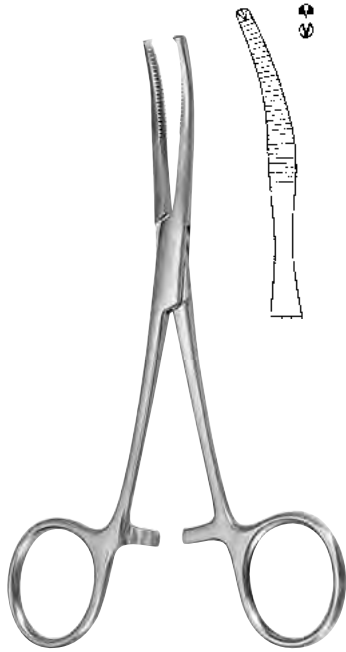

BABY-MIKULICZ
1153-4314 14,0 cm / 5³/₄"

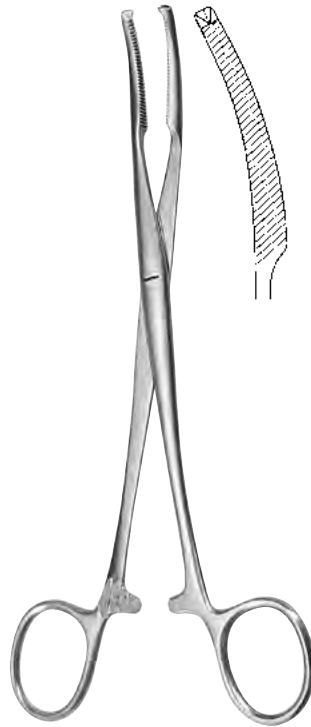

MIKULICZ
1153-5118 18,0 cm / 7"
1153-5120 20,0 cm / 8"

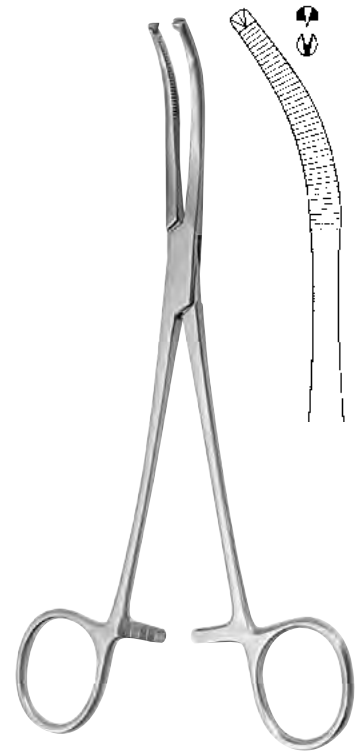

MIKULICZ
1153-4318 18,0 cm / 7"
1153-4120 20,0 cm / 8"

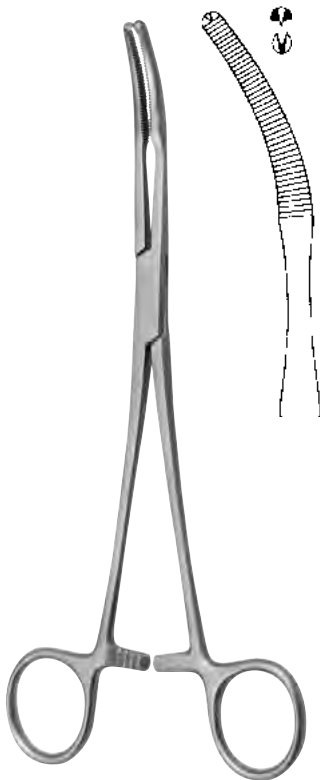

MIKULICZ
1153-4320 20,0 cm / 8"



MIKULICZ
1153-3920 20,5 cm / 8"



FAURE
1153-4520 - 1153-4519 20,0 cm / 8"

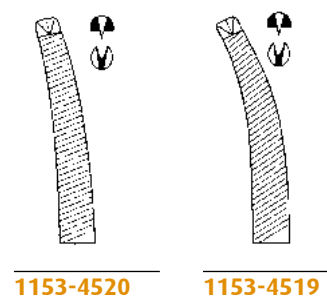

1153-4520 **1153-4519**



1153-1421

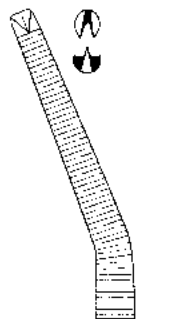

1153-1521

PHANEUF

1153-1421 - 1153-1521 21,5 cm / 8 1/2"



1153-0722

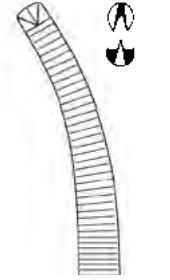

1153-0723

WERTHEIM

1153-0722 - 1153-0723 23,0 cm / 9"



1153-1323

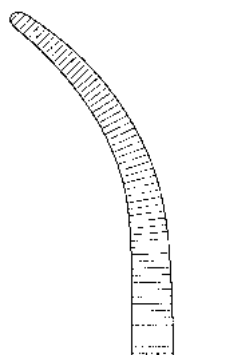

1153-1324

MOYNIHAN

1153-1323 23,0 cm / 9"
1153-1324 24,0 cm / 9 1/2"



WERTHEIM

1153-0525 25,0 cm / 10"

Hysterektomieklemmen
Hysterectomy Forceps
Pinzas-clamps para histerectomía
Pinze per isterectomia

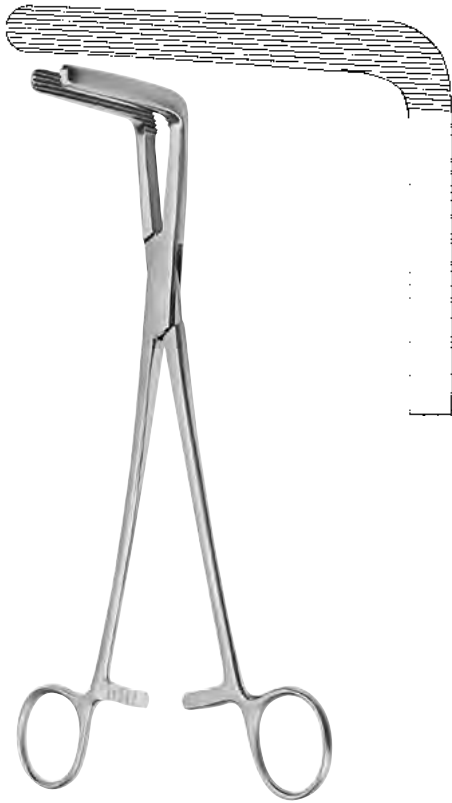

WERTHEIM-CULLEN
1153-3521 21,5 cm / 8¹/₂"

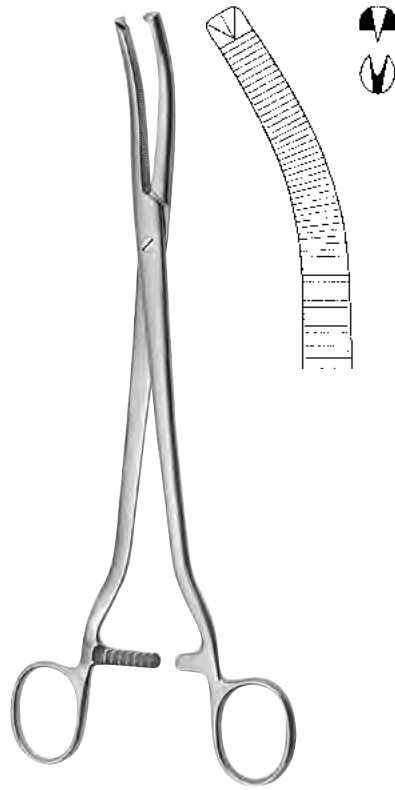

WERTHEIM
1153-0224 24,0 cm / 9¹/₂"

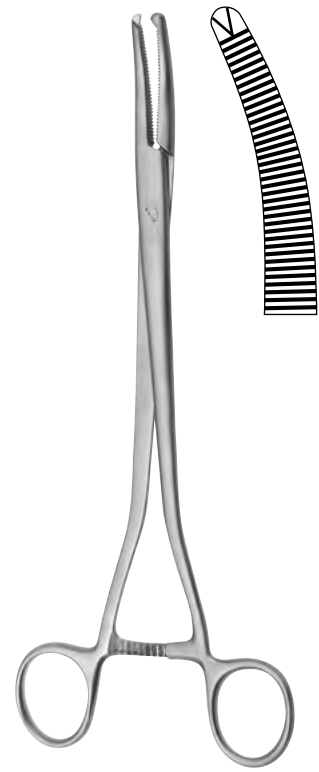

WERTHEIM
1153-0423 23,5 cm / 9¹/₄"

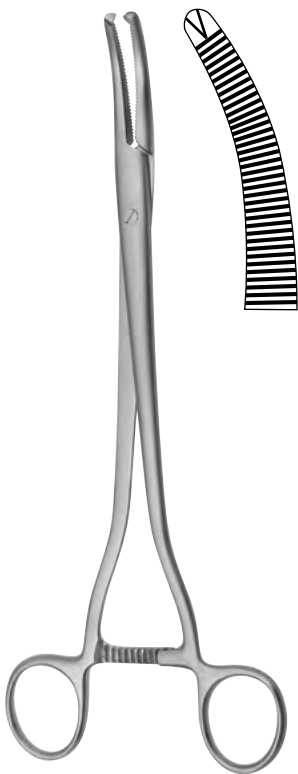

WERTHEIM
1153-0523 23,5 cm / 9¹/₄"

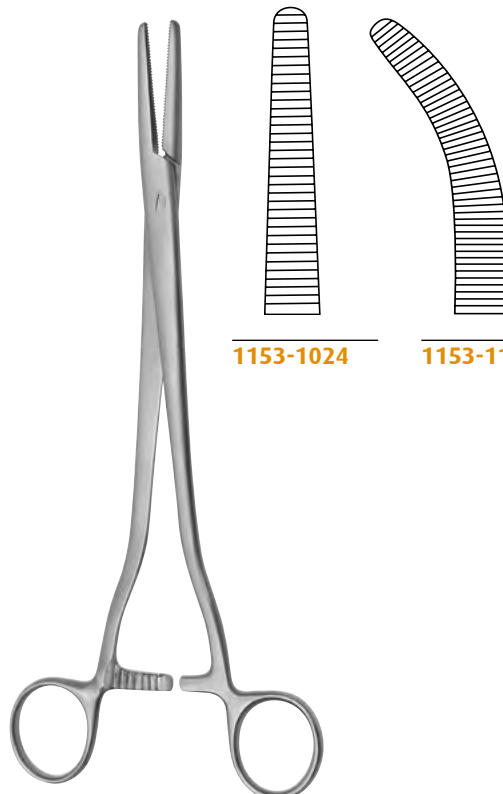

SEGOND-LANDAU
1153-1024 24,5 cm / 9²/₃"
1153-1124 24,0 cm / 9¹/₂"

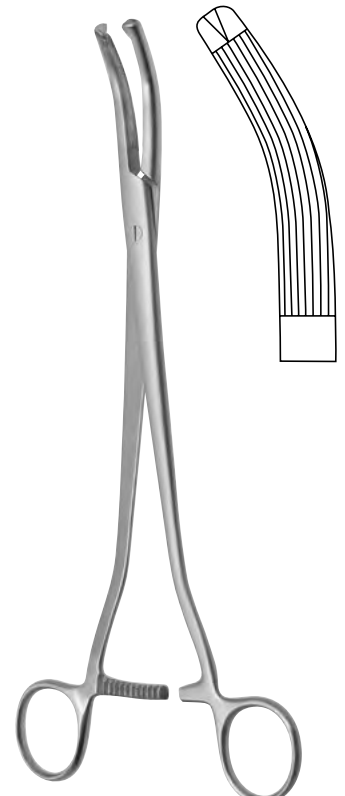

MIKULICZ
1153-4924 24,5 cm / 9²/₃"

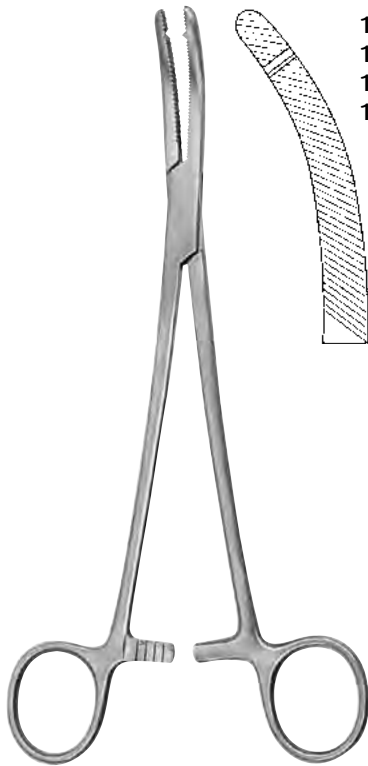

1 Zahn
1 tooth
1 diente
1 dente

HEANEY

1153-1720 19,5 cm / 7³/₄"
1153-1721 21,0 cm / 8¹/₄"
1153-1723 23,0 cm / 9"

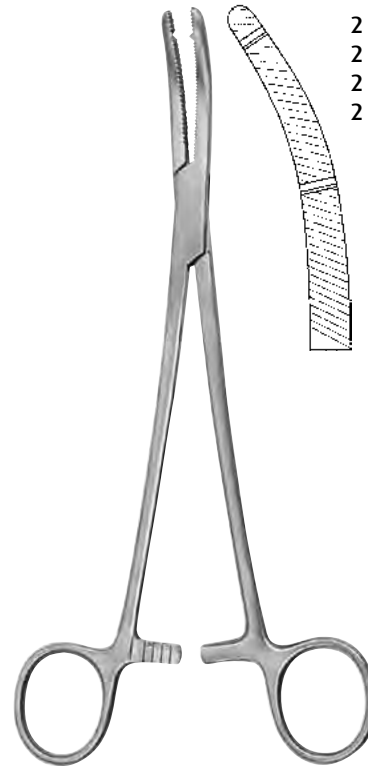

2 Zähne
2 teeth
2 dientes
2 denti

HEANEY

1153-1920 19,5 cm / 7³/₄"
1153-1921 21,0 cm / 8¹/₄"
1153-1923 23,0 cm / 9"

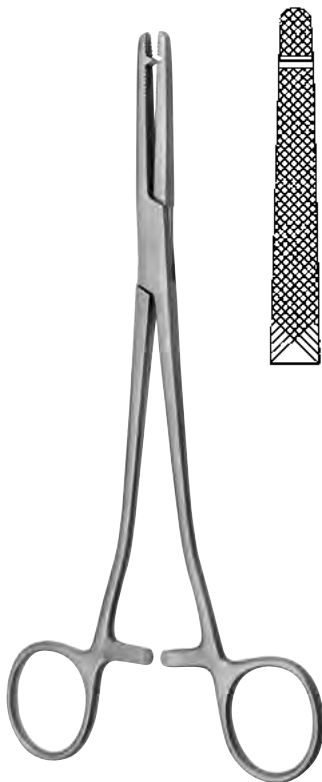

HEANEY-REZEK

1153-1621 21,0 cm / 8¹/₄"

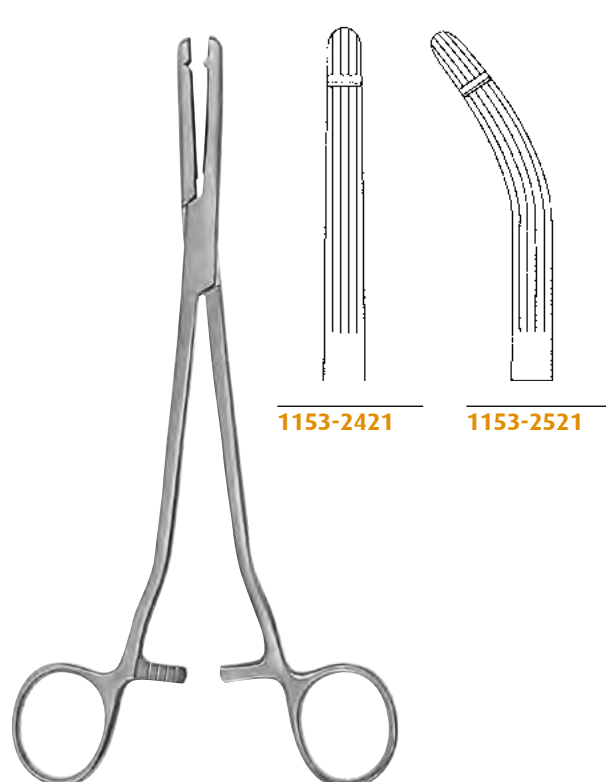

HEANEY-BALLENTINE

1153-2421 - 1153-2521 21,0 cm / 8¹/₄"

Hysterektomieklemmen
Hysterectomy Forceps
Pinzas-clamps para histerectomía
Pinze per isterectomia

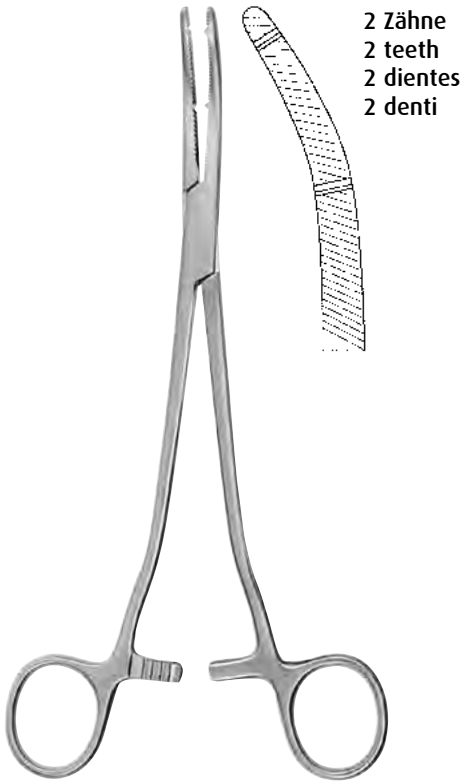

HEANEY-KANTER

1153-2021 21,0 cm / 8¹/₄"

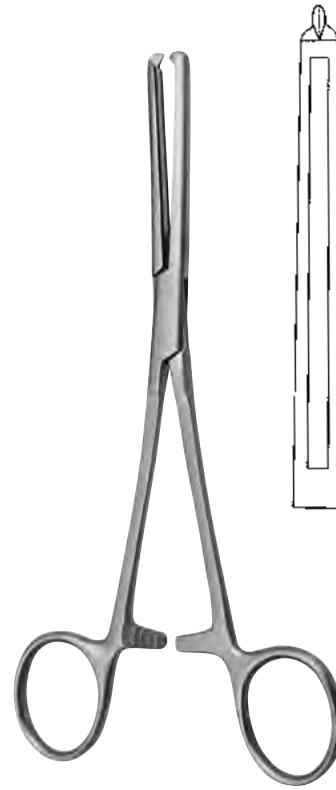

MAINGOT

1153-2220 20,0 cm / 8"

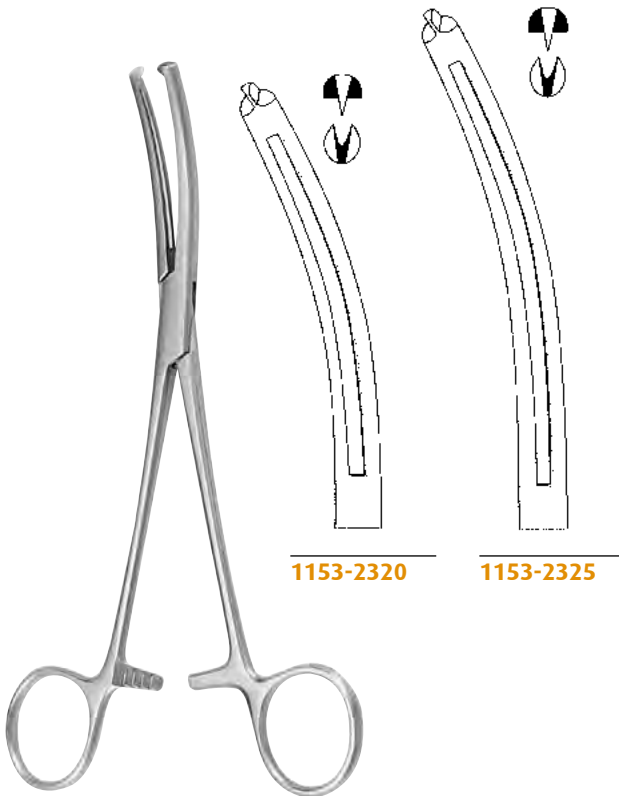

MAINGOT

1153-2320 20,5 cm / 8"
1153-2325 25,0 cm / 10"

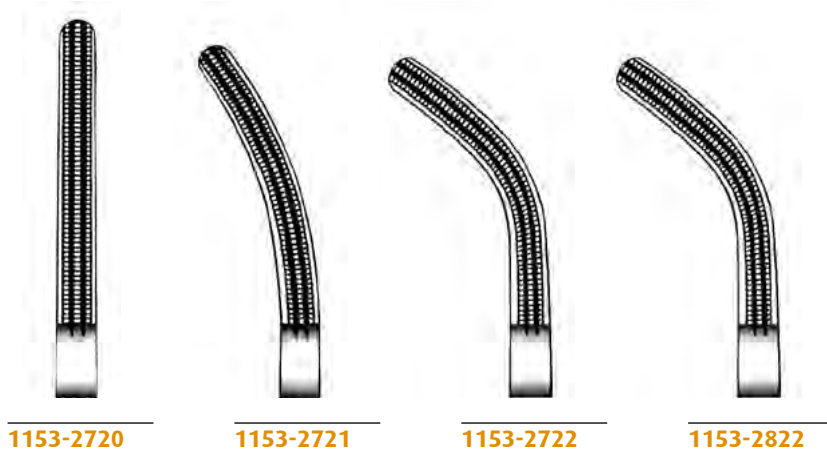

1153-2720

1153-2721

1153-2722

1153-2822

ROGERS

1153-2720	21,5 cm / 8 ¹ / ₂ "
1153-2721	21,0 cm / 8 ¹ / ₄ "
1153-2722	20,5 cm / 8"
1153-2822	20,0 cm / 8"

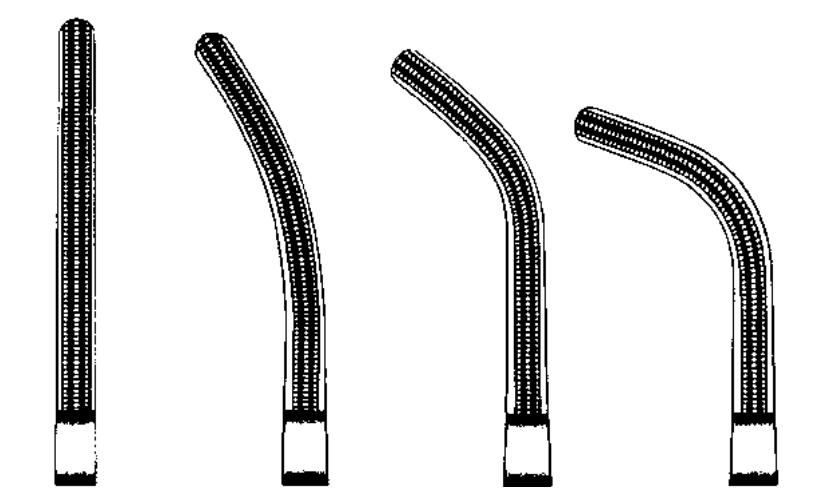

1153-3025

1153-2925

1153-2924

1153-2923

ROGERS

1153-3025	25,0 cm / 9 ³ / ₄ "
1153-2925	25,0 cm / 9 ³ / ₄ "
1153-2924	24,5 cm / 9 ² / ₃ "
1153-2923	23,0 cm / 9 ¹ / ₄ "

Tuchklemmen
Towel Clamps
Pinzas de campo
Pinze per fissare le compresse



SCHAEDEL

1158-1709 9,0 cm / 3 1/2"



ENGL. MODELL

1158-1809 9,0 cm / 3 1/2"



JONES

1158-1905 5,0 cm / 2"
1158-1909 9,0 cm / 3 1/2"

mit Schlauch- oder Kabelhalter
with clip for tubing or cable
con porta-tubo o porta-cable
con porta-tubo o porta-cavo



mit Schlauchhalter
with tube holder
con porta-tubo
con porta-tubo

JONES

1158-2009 9,0 cm / 3 1/2"

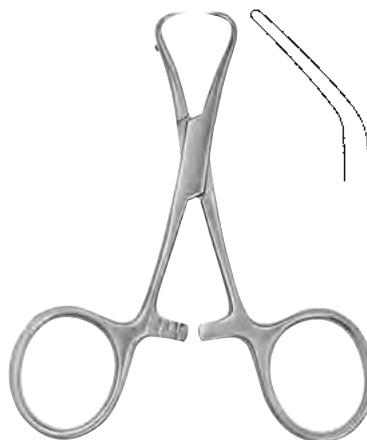

BACKHAUS

1158-0108 8,0 cm / 3 1/8"
1158-0111 11,0 cm / 4 3/8"
1158-0113 13,0 cm / 5 1/8"
1158-0115 15,0 cm / 6"



1158-0311 11,0 cm / 4 3/8"



ROEDER

1158-0913 13,0 cm / 5¹/₈"
1158-0915 15,0 cm / 6"



LORNA

1158-2310 10,0 cm / 4"
1158-2313 13,0 cm / 5"



1158-2310

1158-2313



BERNHARD

1158-0716 16,5 cm / 6¹/₂"



LANE

1158-1115 15,0 cm / 6"
1158-1118 18,0 cm / 7"
1158-1120 20,0 cm / 8"



BALL + SOCKET

1158-0511 11,5 cm / 4¹/₂"
1158-0514 13,0 cm / 5¹/₃"

Tuchklemmen
Towel Clamps
Pinzas de campo
Pinze per fissare le compresse

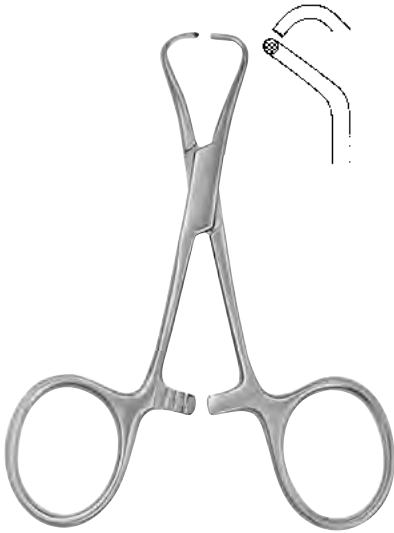

TOHOKU

1158-2510 10,0 cm / 4"
1158-2513 13,0 cm / 5¹/₃"



PEERS

1158-2114 14,5 cm / 5³/₄"

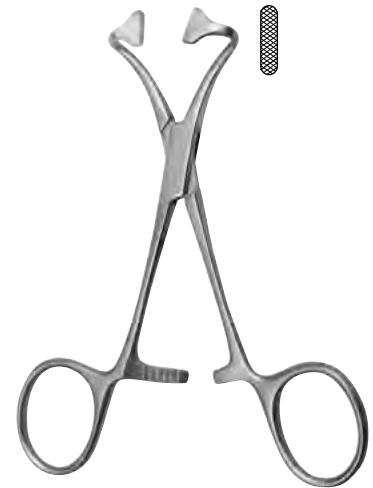

1158-2710 10,0 cm / 4"
1158-2713 13,0 cm / 5¹/₈"



HOFF

1158-2912 11,0 cm / 4³/₈"
1158-2914 14,5 cm / 5³/₄"



ROBIN

1158-0213 13,5 cm / 5¹/₄"

für Kabel bis Ø 5 mm
 for cables up to Ø 5 mm
 para cables hasta Ø 5 mm
 per cavo fino a Ø 5 mm

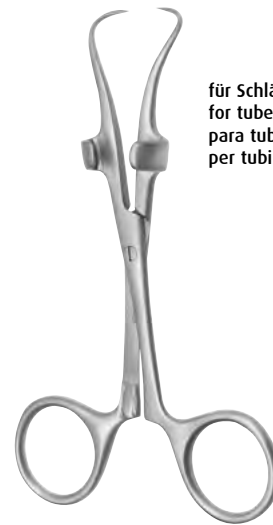

ROBIN

1158-0214 13,5 cm / 5¹/₄"

für Schläuche bis Ø 13 mm
 for tubes up to Ø 13 mm
 para tubos hasta Ø 13 mm
 per tubi fino a Ø 13 mm

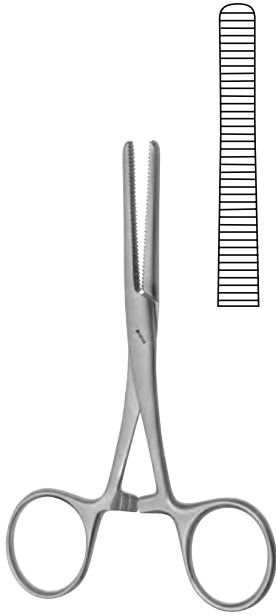

PEAN

1150-0612 12,5 cm / 5"



BERLIN

1158-4214 14,5 cm / 5³/₄"

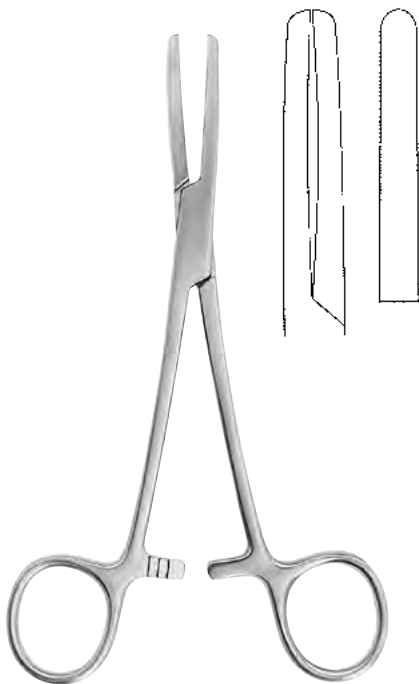

glatt
smooth
lisa
liscio

PRESBYTERIAN

1158-4016 16,0 cm / 6¹/₄"
1158-4018 18,0 cm / 7"
1158-4020 20,0 cm / 8"

Schlauchklemmen
 Tubing Clamps
 Pinzas para tubos
 Pinze per tubi



- 1158-4415 15,5 cm / 6 1/8"
- 1158-4418 18,0 cm / 7"
- 1158-4420 20,0 cm / 8"

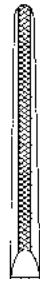

1158-4415

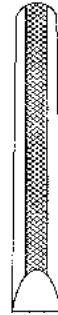

1158-4418

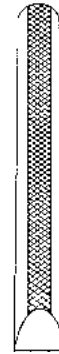

1158-4420



- 1158-4615 15,5 cm / 6 1/8"
- 1158-4618 18,0 cm / 7"
- 1158-4620 20,0 cm / 8"



1158-4615



1158-4618

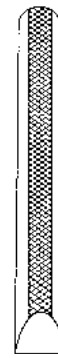

1158-4620

mit Schutzbügel
 with safety guard
 con estribo de protección
 con protezione

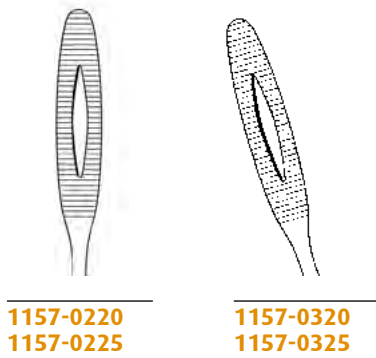

1157-0220
1157-0225

1157-0320
1157-0325

GROSS-MAIER

1157-0220 – 1157-0320 20,0 cm / 8"
 1157-0225 – 1157-0325 26,5 cm / 10¹/₂"

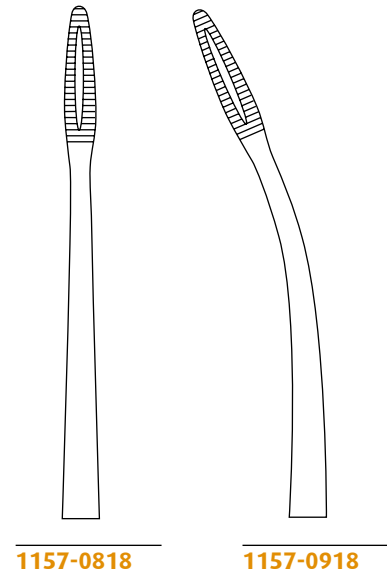

1157-0818

1157-0918

GROSS

1157-0818 – 1157-0918 18,0 cm / 7"

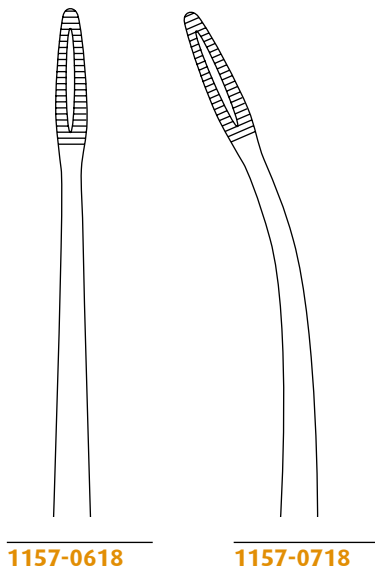

1157-0618

1157-0718

GROSS

1157-0618 – 1157-0718 18,0 cm / 7"

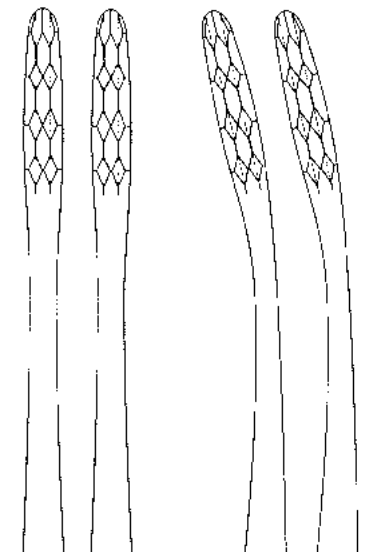

1157-0022
1157-0025
1157-0027

1157-0122
1157-0125
1157-0127

ULRICH

1157-0022 – 1157-0122 22,0 cm / 8³/₄"
 1157-0025 – 1157-0125 25,0 cm / 9³/₄"
 1157-0027 – 1157-0127 27,0 cm / 10³/₄"

Korn- und Tupferzangen
Sponge and Dressing Forceps
Pinzas para vendajes y torundas
Pinze per medicatura e tamponi

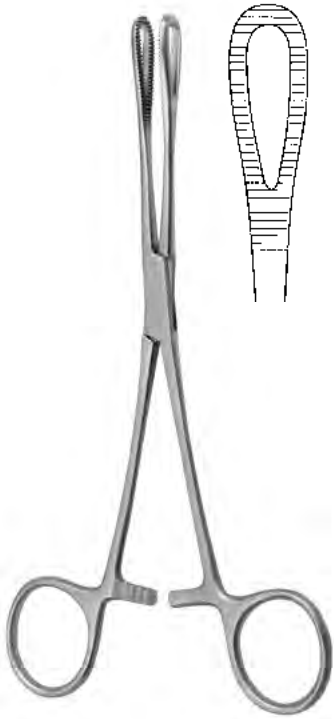

RAMPLEY

1157-4218 18,0 cm / 7"
1157-4225 25,0 cm / 9³/₄"



LISTER

1157-1413 13,0 cm / 5¹/₈"
1157-1416 16,0 cm / 6¹/₄"
1157-1418 18,0 cm / 7"

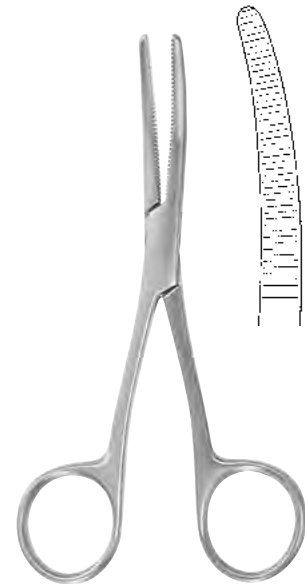

BRYANT

1157-1513 13,0 cm / 5¹/₈"



SIMS-MAIER

1157-2028 - 1157-2128 28,0 cm / 11"

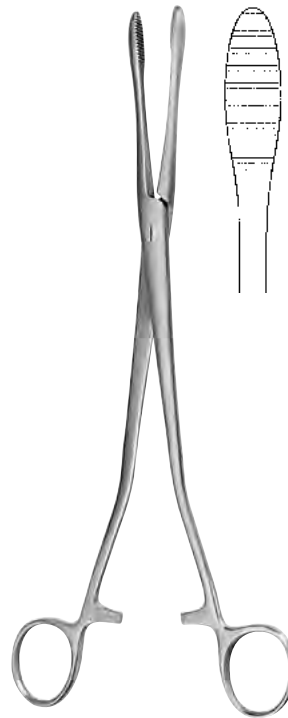
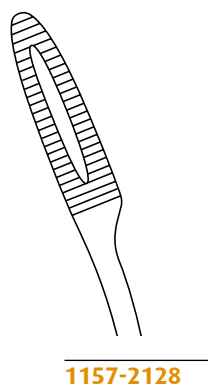

COLLIN

1157-1825 25,0 cm / 9³/₄"

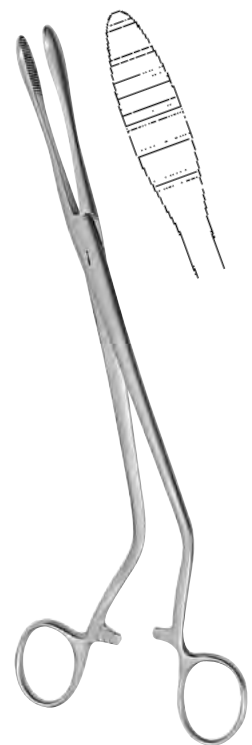

CHERON

1157-1925 25,0 cm / 9³/₄"

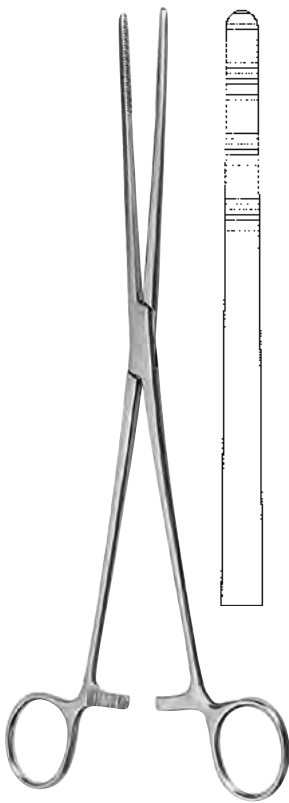

BOZEMANN
1157-1626 26,0 cm / 10¹/₄"

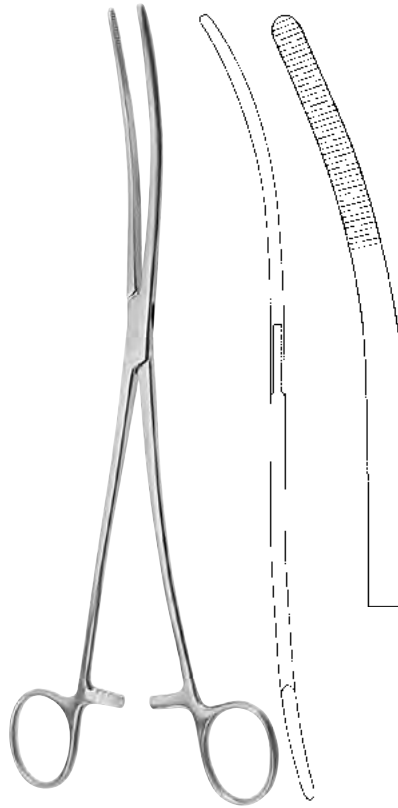

BOZEMANN
1157-1726 26,0 cm / 10¹/₄"

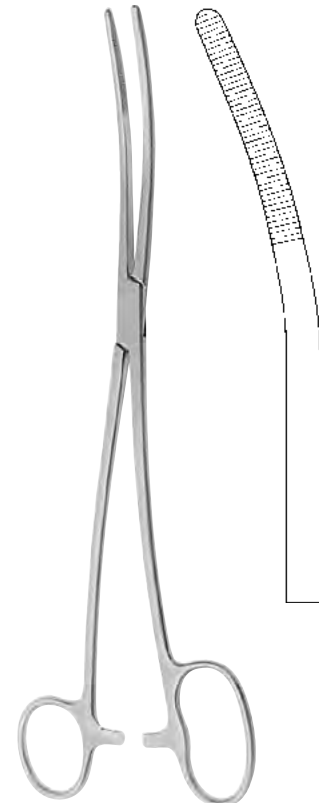

BOZEMANN-DOUGLAS
1157-1926 26,0 cm / 10¹/₄"



FOERSTER
1157-3618 - 1157-3918 18,0 cm / 7"
1157-3620 - 1157-3920 20,0 cm / 8"
1157-3625 - 1157-3925 25,0 cm / 9³/₄"

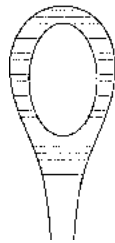

1157-3618
1157-3620
1157-3625

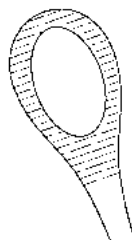

1157-3718
1157-3720
1157-3725



1157-3818
1157-3820
1157-3825



1157-3918
1157-3920
1157-3925

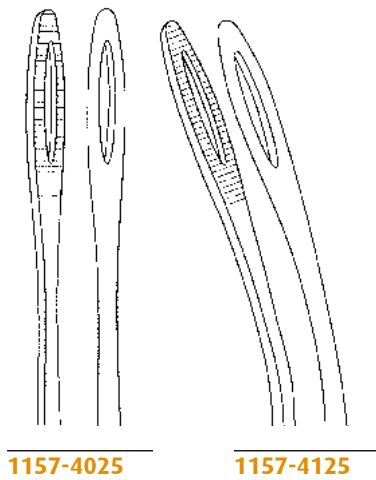

FOERSTER

1157-4025 - 1157-4125

25,0 cm / 9³/₄"



RAMPLEY

1157-4325

25,0 cm / 9³/₄"

**Wundhaken, Wundspreizer, Bauchdeckenhalter
Retractors, Self-retaining Retractors, Abdominal Retractors
Separadores, Separadores autoestáticos, Separadores abdominales
Divaricatori, Divaricatori autostatici, Divaricatori addominali**





1161-1001



1161-1002



1161-1003



1161-1004

1161-1001 - 1161-1004

16,0 cm / 6 1/4"

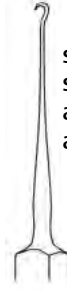

1161-0801

scharf
sharp
agudo
acuto



1161-0901

stumpf
blunt
romo
smusso

GRAEFE

1161-0801 - 1161-0901

15,0cm / 6"



1161-1201



1161-1202

scharf
sharp
agudo
acuto

GUTHRIE

1161-1201 - 1161-1202

15,5 cm / 6 1/4"



O'CONNOR

1161-1101

16,0 cm / 6 1/4"

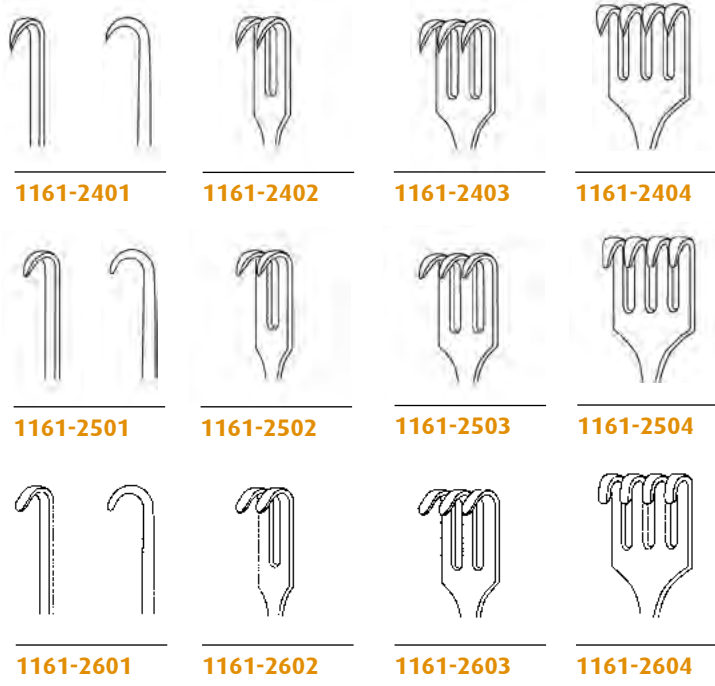

scharf
sharp
agudo
acuto

halbscharf
semi-sharp
semi-agudo
semi-acuto

stumpf
blunt
romo
smusso

1161-2401 - 1161-2604

16,0 cm / 6¹/₄"

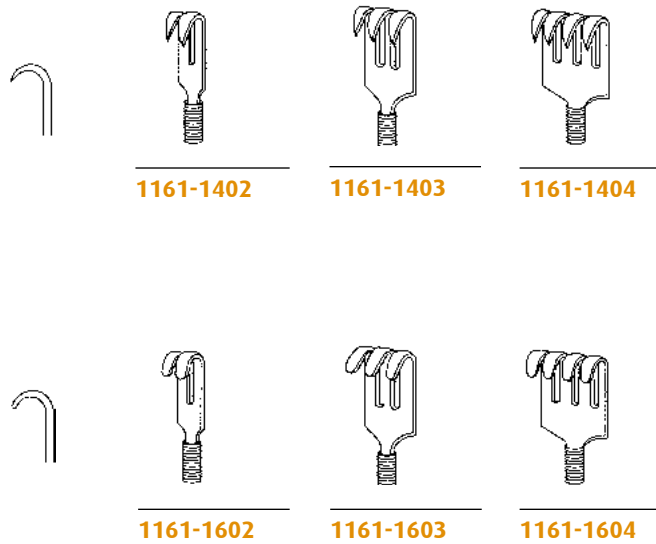

scharf
sharp
agudo
acuto

stumpf
blunt
romo
smusso

flexibel, flexible, flexibles, flessibili

1161-1402 - 1161-1604

16,0 cm / 6¹/₄"



1161-1501 Fig.1

scharf
sharp
agudo
acuto



1161-1502 Fig.2

stumpf
blunt
romo
smusso



KNAPP

1161-1501 - 1161-1502 13,0 cm / 5"



1161-2808 8,0 mm



1161-2810 10,0 mm

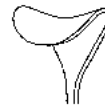

1161-2812 12,0 mm

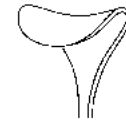

1161-2814 14,0 mm



1161-2816 16,0 mm

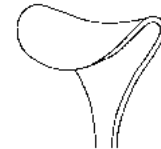

1161-2818 18,0 mm

DESMARRES

1161-2808 - 1161-2818 16,0 cm / 6 1/4"



1161-4010 10x6 mm

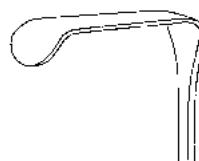

1161-4017 17x5 mm

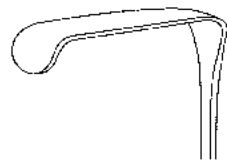

1161-4020 20x6 mm



1161-4022 22x8 mm

MINI-LANGENBECK

1161-4010 - 1161-4022 16,0 cm, 6 1/4"

**Wundhaken
Retractors
Separadores
Divaricatori**

016



1161-1901 14x8 mm

stumpf
blunt
romo
smusso

16,0 cm, 6 1/4"

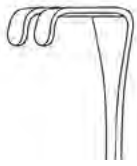

1161-4501 18x7 mm **1161-4502** 16x5 mm **1161-4503** 7x4 mm

1161-4504 10x3 mm **1161-4505** 7x4 mm **1161-4506** 10x4 mm

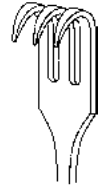
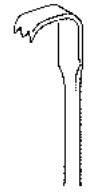

MEYERDING

1161-4501 - 1161-4506 16,0 cm / 6 1/4"



scharf
sharp
agudo
acuto



1161-2001



1161-2002



1161-2003



1161-2004

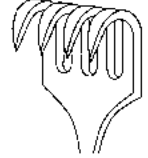

Kehlengriff
serrated handle
mango serrado
manico striate

stumpf
blunt
romo
smusso

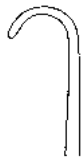

1161-2201

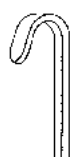

1161-2202



1161-2203



1161-2204

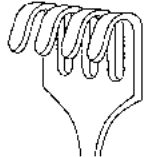

1161-2001 - 1161-2204 16,5 cm, 6 1/2"

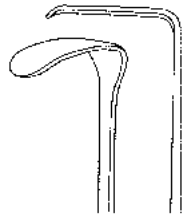

1161-4103 16x6 mm

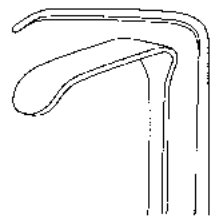

1161-4104 24x6 mm

LANGENBECK-GREEN

1161-4103 - 1161-4104 15,0 cm / 6"



1161-3810 10x6 mm



1161-3820 20x6 mm

1161-3810 - 1161-3820 15,0 cm / 6"



RAGNELL-DAVIS

1161-4214 14,0 cm / 5 1/2"



RAGNELL

1160-6015 15,0 cm / 6"

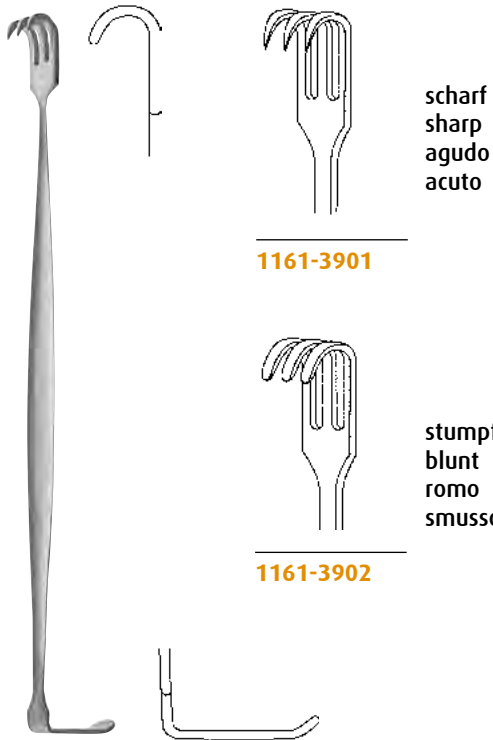

SENN-MILLER

1161-3901 - 1161-3902 16,0 cm / 6 1/4"

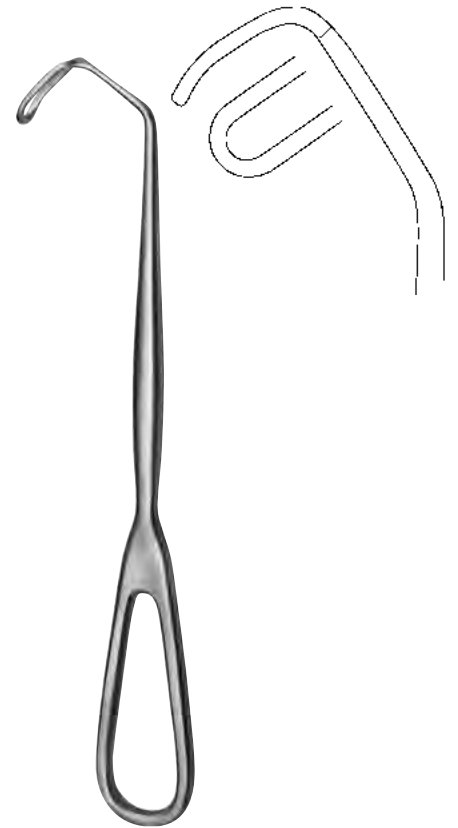

CUSHING

1161-4420 20,0 cm / 8"

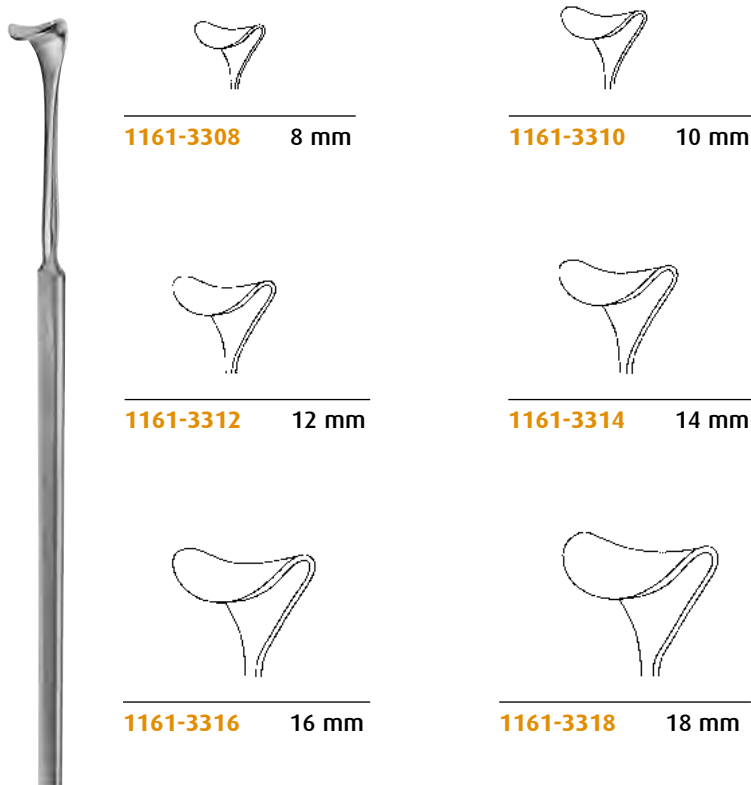

CUSHING

1161-3308 - 1161-3318 20,0 cm / 8"



1161-3408 8 mm



1161-3410 10 mm



1161-3412 12 mm



1161-3414 14 mm



1161-3416 16 mm



1161-3418 18 mm

CUSHING

1161-3408 - 1161-3418 24,0 cm / 9 1/2"

flexibel
flexible
flexible
flessibile



1161-3608 8 mm

1161-3611 11 mm

1161-3613 13 mm

1161-3617 17 mm

1161-3620 20 mm

1161-3623 23 mm

GIL-VERNET

1161-3608 - 1161-3623 24,0 cm / 9 1/2"



1161-4301

Fig. 1
glatt
smooth
lisa
liscio

1161-4320

Fig. 2
gezahnt
toothed
dentado
dentate

STRANDELL-STILLE

1161-4301 - 1161-4320 19,0 cm / 7 1/2"



CUSHING

1161-4421 21,5 cm / 8 1/2"

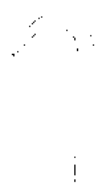

1160-0801
scharf
sharp
agudo
acuto



1160-0802

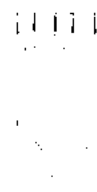

1160-0803

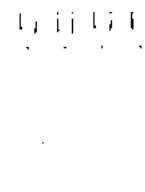

1160-0804

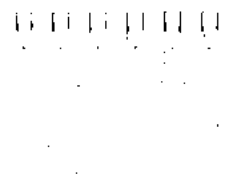

1160-0806

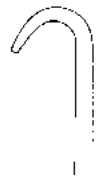

1160-0901
stumpf
blunt
romo
smusso



1160-0902



1160-0903



1160-0904

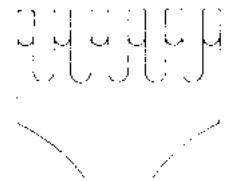

1160-0906

VOLKMANN

1160-0801 - 1160-0906

21,5 cm / 8 1/2"

scharf
sharp
agudo
acuto

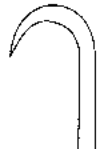

1160-0101



1160-0102 9x8 mm



1160-0103 9x13 mm



1160-0104 9x19 mm

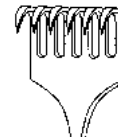

1160-0106 9x29 mm

VOLKMANN

1160-0101 - 1160-0106

22,0 cm / 8 1/2"

**Wundhaken
Retractors
Separadores
Divaricatori**

halbscharf
semi-sharp
semi-agudo
semi-acuto

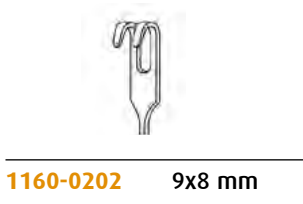
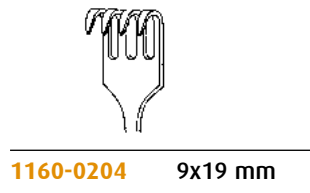
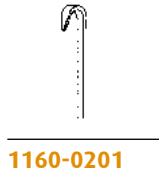

VOLKMANN

1160-0201- 1160-0206 22,0 cm / 8³/₄"

stumpf
blunt
romo
smusso

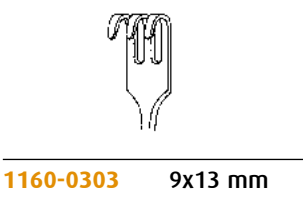
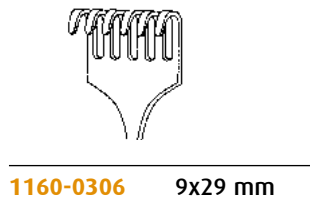
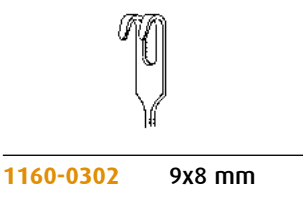
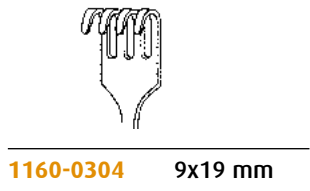

VOLKMANN

1160-0301 - 1160-0306 22,0 cm / 8³/₄"

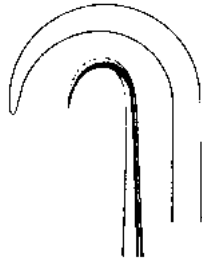

1160-1001
scharf
sharp
agudo
acuto

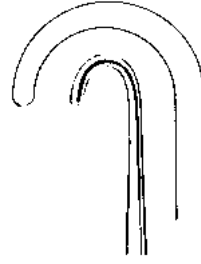

1160-1101
stumpf
blunt
romo
smusso

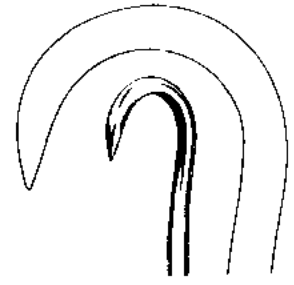

1160-1201
scharf
sharp
agudo
acuto

VOLKMANN

1160-1001 - 1160-1201

21,5 cm / 8 1/2"

scharf
sharp
agudo
acuto



1160-0501



1160-0504 15x20 mm



1160-0502 9x8 mm

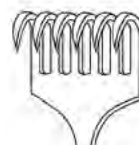

1160-0506 15x30 mm



1160-0503 15x15 mm

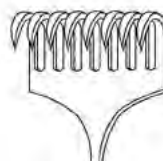

1160-0508 15x40 mm

KOCHER

1160-0501 - 1160-0508

22,0 cm / 8 5/8"

**Wundhaken
Retractors
Separadores
Divaricatori**

halbscharf
semi-sharp
semi-agudo
semi-acuto



1160-0601



1160-0604 15x20 mm



1160-0602 9x8 mm

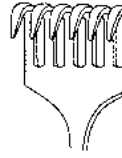

1160-0606 15x30 mm



1160-0603 15x15 mm

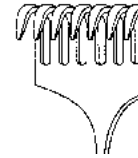

1160-0608 15x40 mm

KOCHER

1160-0601 - 1160-0608

22,0 cm / 8⁵/₈"

stumpf
blunt
romo
smusso

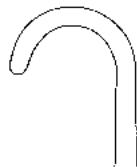

1160-0701

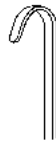

1160-0704 15x20 mm

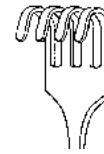

1160-0702 9x8 mm

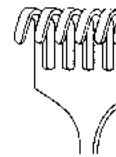

1160-0706 15x30 mm



1160-0703 15x15 mm

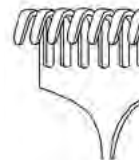

1160-0708 15x40 mm

KOCHER

1160-0701 - 1160-0708

22,0 cm / 8⁵/₈"



OLLIER

1160-1604 23,0 cm / 9" 36x35 mm

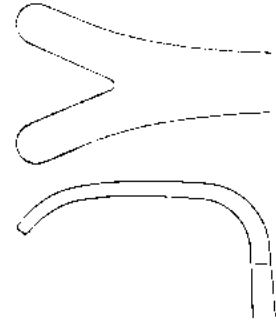

OLLIER

1160-1603 23,0 cm / 9" 36x60 mm

WASSMUND

1160-1602 20,5 cm / 8" 33x21 mm

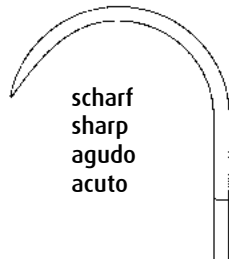

scharf
sharp
agudo
acuto

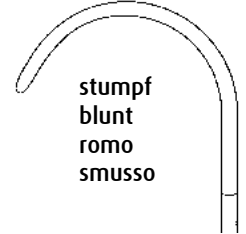

stumpf
blunt
romo
smusso

KOERTE

1160-1408 24,0 cm / 9 1/2"

KOERTE

1160-1508 24,0 cm / 9 1/2"



stumpf
blunt
romo
smusso

ISRAEL

1160-1704 - 1160-1707 25,0 cm / 9³/₄"



1160-1704 40x40 mm

4 Zähne
4 teeth
4 dientes
4 denti



1160-1705 45x50 mm

5 Zähne
5 teeth
5 dientes
5 denti

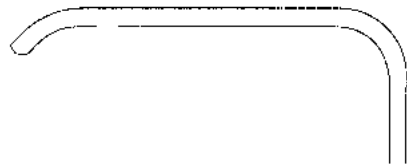

1160-1706 50x60 mm

6 Zähne
6 teeth
6 dientes
6 denti

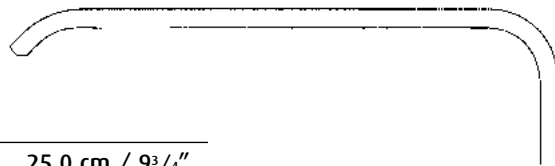

1160-1707 70x70 mm

6 Zähne
6 teeth
6 dientes
6 denti

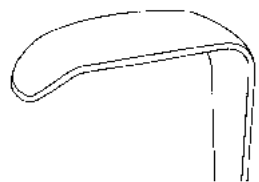

1160-1811 30x11 mm

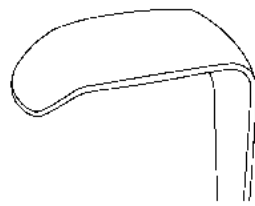

1160-1812 30x14 mm

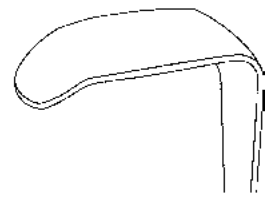

1160-1813 30x16 mm

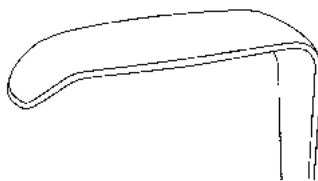

1160-1815 40x11 mm

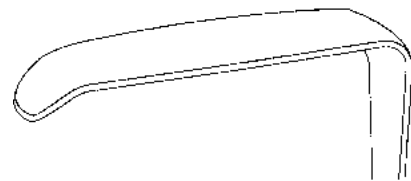

1160-1817 50x11 mm

LANGENBECK

1160-1811 - 1160-1817 22,5 cm / 9"

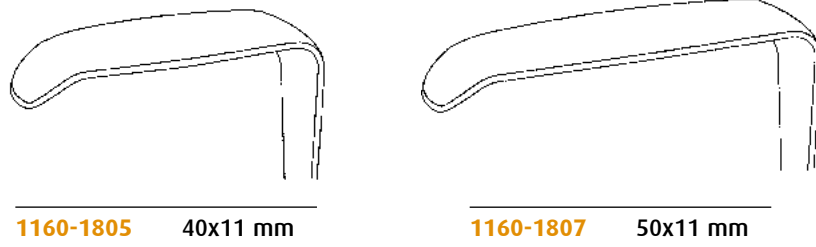
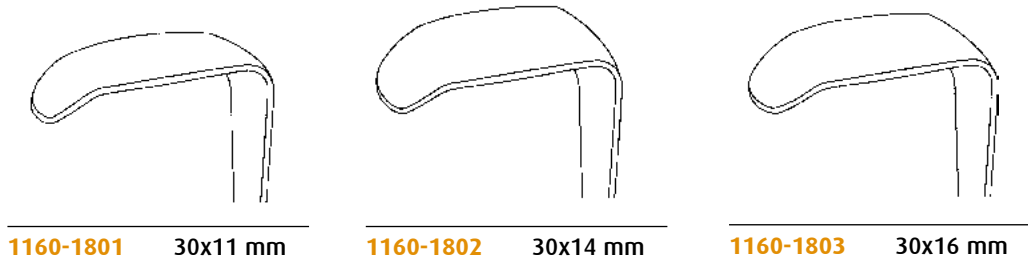

LANGENBECK

1160-1801 - 1160-1807 22,0 cm / 8⁵/₈"



85x15 mm

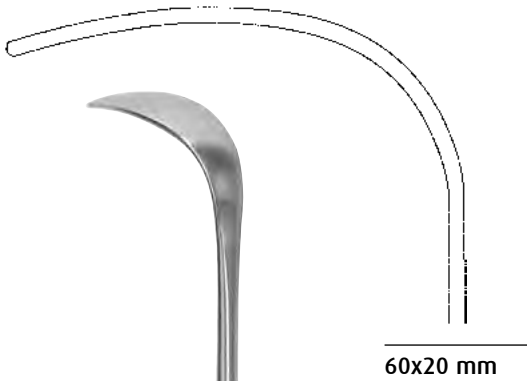

LANGENBECK

1160-2001 21,0 cm / 8¹/₄"

LANGENBECK

1160-1901 22,5 cm / 9"



LAHEY
1161-3719 19,0 cm / 7½"



LITTLE
1161-3720 20,0 cm / 8"



KOCHER-LANGENBECK

1160-2500 - 1160-2509

21,5 cm / 8 1/2"

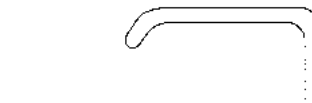

1160-2500 25x6 mm

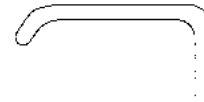

1160-2102 30x11 mm

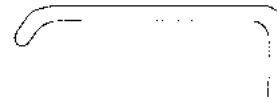

1160-2502 35x8 mm

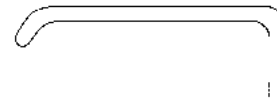

1160-2503 35x11 mm



1160-2504 35x15 mm

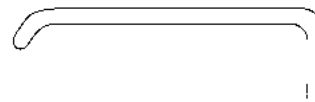

1160-2505 40x11 mm

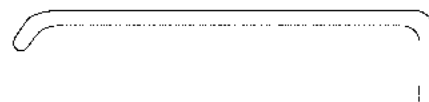

1160-2506 55x11 mm



1160-2507 70x15 mm

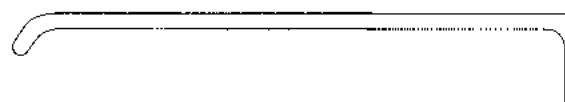

1160-2508 80x12 mm

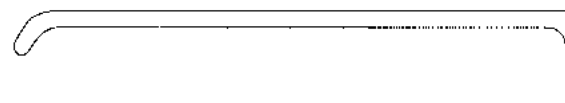

1160-2509 80x15 mm



KOCHER

1160-2701 - 1160-2705 23,0 cm / 9"



1160-2701 40x18 mm



1160-2702 60x20 mm



1160-2703 60x25 mm

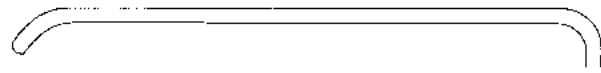

1160-2704 75x30 mm

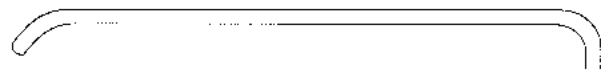

1160-2705 75x40 mm



SAUERBRUCH

1160-1821 - 1160-1823 22,5 cm / 8³/₄"

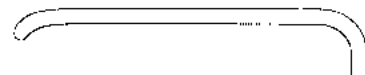

1160-1821 50x15 mm

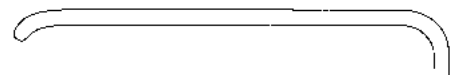

1160-1822 63x23 mm

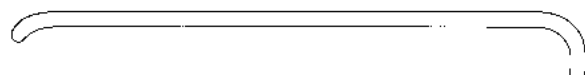

1160-1823 80x20 mm



ZENKER

1160-2601	25,0 cm / 9 ³ / ₄ "
1160-2602	26,0 cm / 10"
1160-2603	27,5 cm / 10 ³ / ₄ "

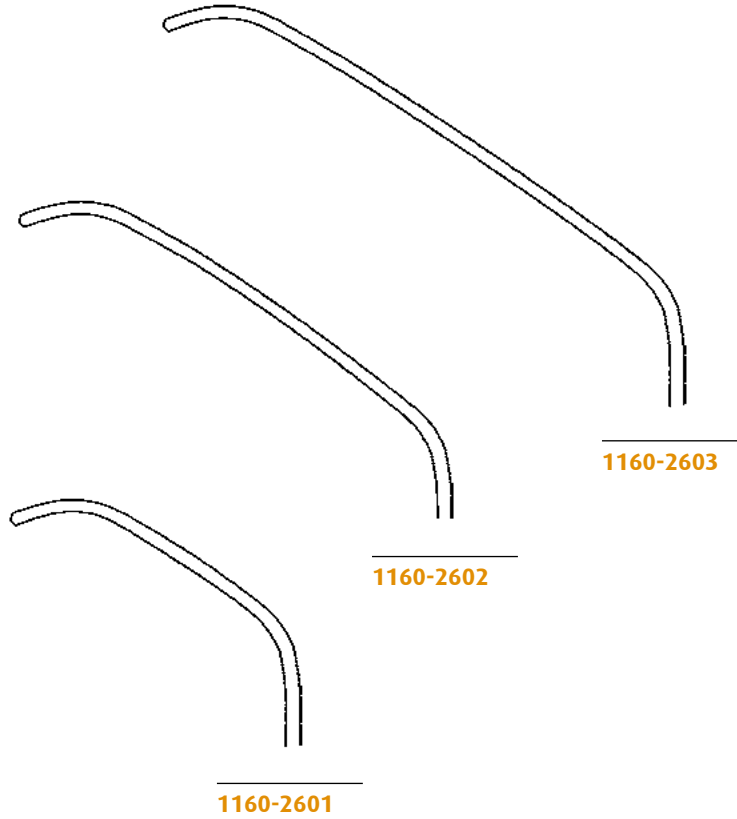

KOCHER

1160-3301	19,0 cm / 7 ¹ / ₂ "	19 x 12 mm
1160-3302	19,0 cm / 7 ¹ / ₂ "	21 x 14 mm



KOCHER

1160-3401	22 cm / 8 ⁵ / ₈ "	42x10 mm
1160-3402	22 cm / 8 ⁵ / ₈ "	42x15 mm
1160-3403	22 cm / 8 ⁵ / ₈ "	43x20 mm



1160-3501 18x17 mm



1160-3502 25x22 mm

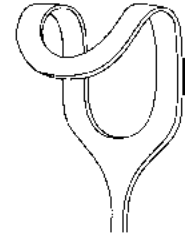

1160-3503 31x30 mm

MIDDELDORPF

1160-3501	21,5 cm / 8 ¹ / ₂ "
1160-3502	23,0 cm / 9"
1160-3503	24,5 cm / 9 ² / ₅ "



1160-3511 14x17 mm



1160-3512 20x22 mm

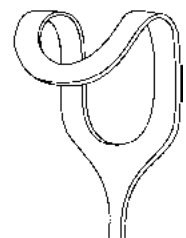

1160-3513 26x30 mm

MIDDELDORPF

1160-3511	21,5 cm / 8 ¹ / ₂ "
1160-3512	22 cm / 8 ⁵ / ₈ "
1160-3513	23,5 cm / 9 ¹ / ₂ "



RICHARDSON-EASTMAN

- 1160-4700** Fig. 1+2 27,0 cm / 10³/₄"
- 1160-4701** Fig. 1 26,0 cm / 10¹/₄"
- 1160-4702** Fig. 2 27,0 cm / 10³/₄"



RICHARDSON

- 1160-4711 - 1160-4714** 24,0 cm / 9¹/₂"



1160-4711 30x21 mm



1160-4712 37x29 mm

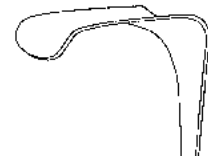

1160-4713 45x40 mm



1160-4714 53x22 mm

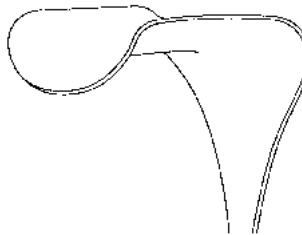

KELLY

- 1160-4722** 26,0 cm / 10¹/₄" 62 x 50 mm

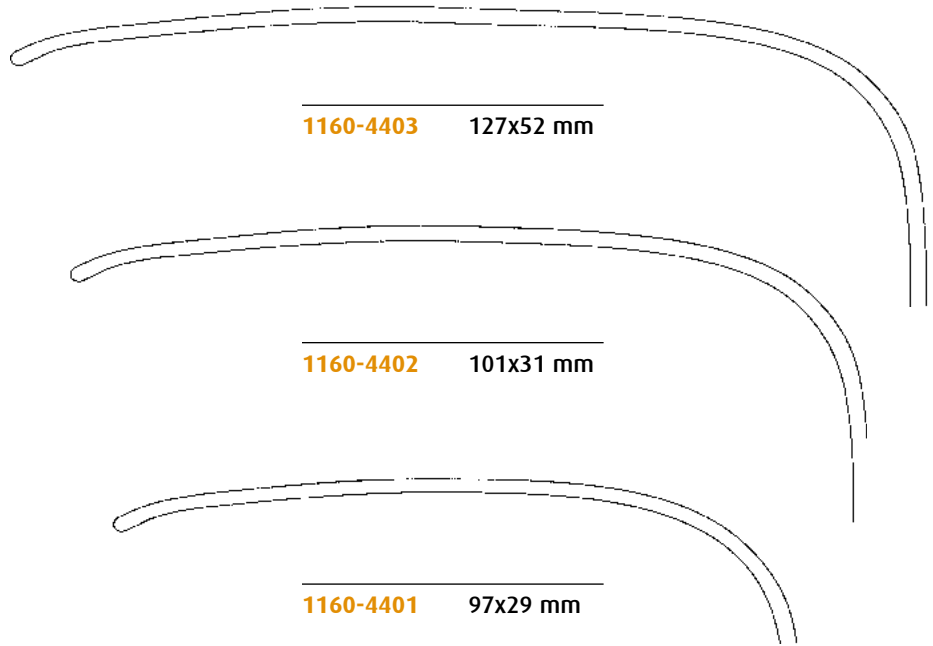

DOYEN-STILLE

1160-4401 - 1160-4403 26,0 cm / 10¹/₄"

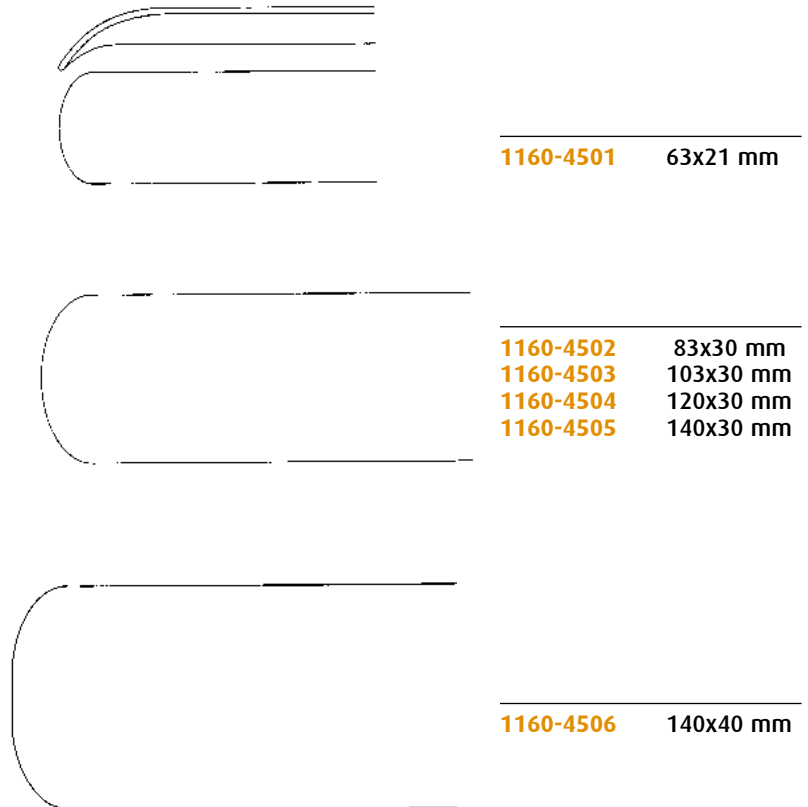

HÖSEL

1160-4501 - 1160-4506 26,0 cm / 10¹/₄"

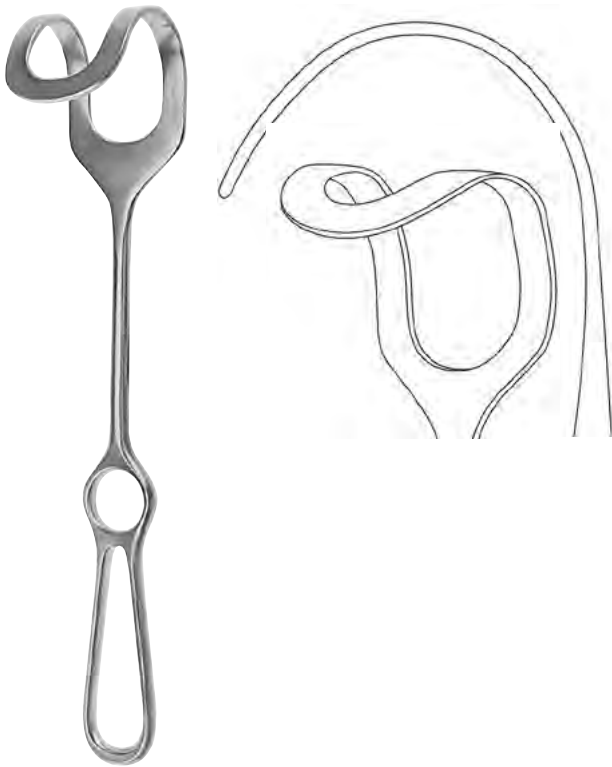

MIDDELDORPF

1160-3601	27,0 cm / 10 ³ / ₄ "	48x45 mm
1160-3602	27,0 cm / 10 ³ / ₄ "	52x50 mm
1160-3603	28,0 cm / 11"	60x70 mm



FRITSCH

1160-3900	23,5 cm / 9 ¹ / ₄ "	30x30 mm
1160-3901	24,0 cm / 9 ¹ / ₂ "	32x40 mm
1160-3902	25,0 cm / 9 ³ / ₄ "	40x50 mm
1160-3903	25,0 cm / 9 ³ / ₄ "	40x60 mm
1160-3904	25,5 cm / 10"	45x75 mm
1160-3905	26,5 cm / 10 ¹ / ₂ "	65x85 mm



DOYEN

1160-3825	25,0 cm / 10"
------------------	---------------

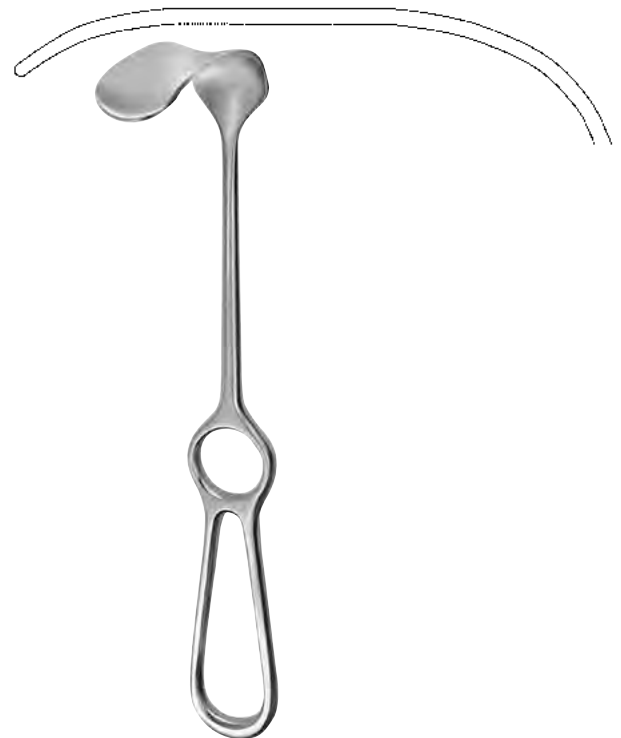

KOCHER

1160-4100	25,0 cm / 10"	70x25 mm
1160-4101	25,0 cm / 10"	80x45 mm
1160-4102	25,0 cm / 10"	80x55 mm
1160-4103	25,0 cm / 10"	80x65 mm

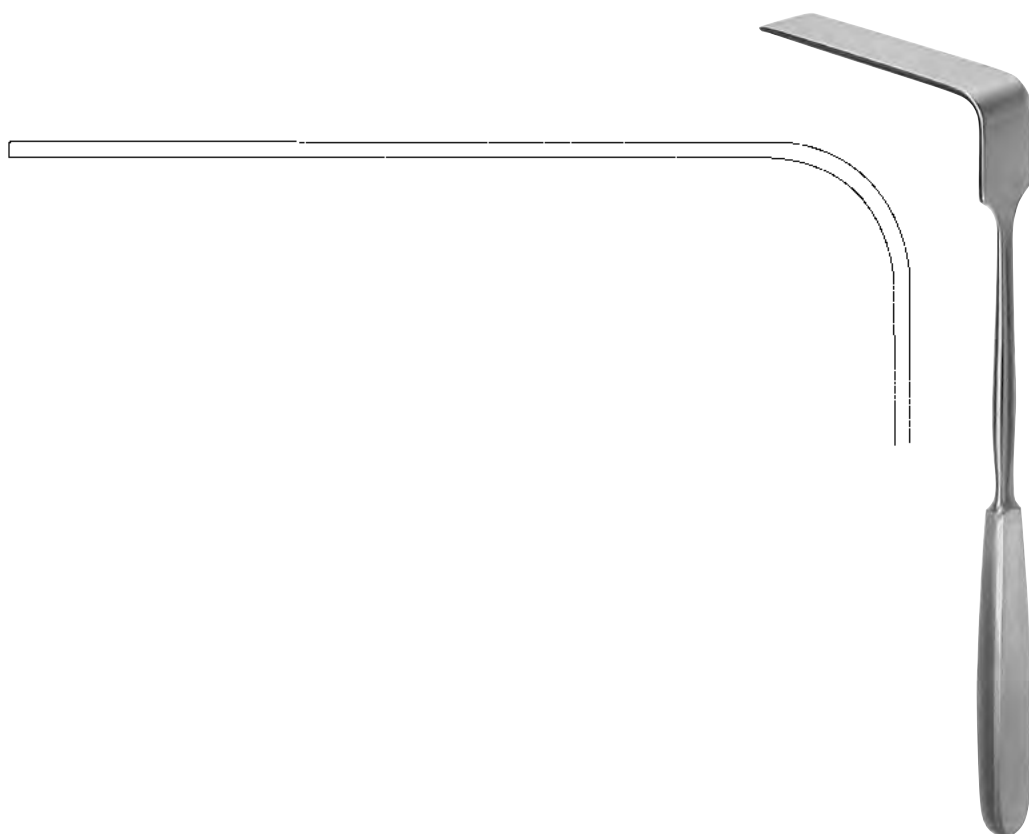

SIMON

1160-4803	28,0 cm / 11"	115x22 mm
1160-4804	28,0 cm / 11"	115x27 mm

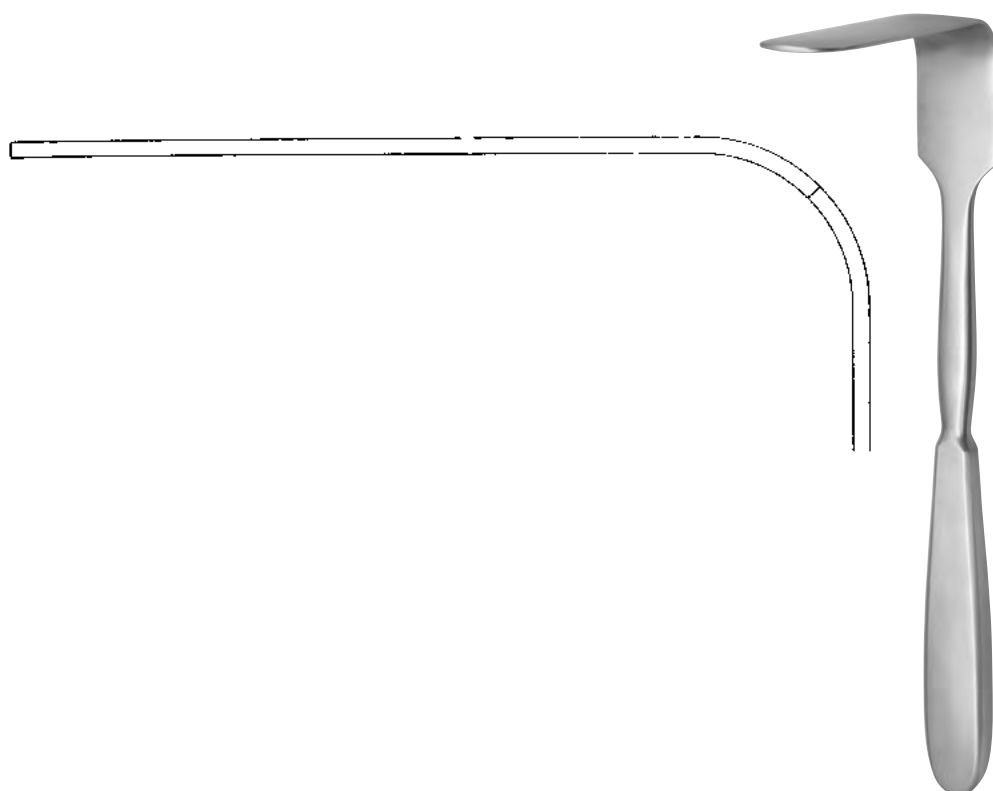

MARTIN

1160-4802	26,0 cm / 10"	110 x 27 mm
------------------	---------------	-------------

**CORYLLOS**

1160-3001	24,0 cm / 9 ¹ / ₂ "	85x22 mm
1160-3002	24,0 cm / 9 ³ / ₄ "	108x43 mm
1160-3003	24,0 cm / 9 ³ / ₄ "	119x65 mm

**DAVIDSON**

1160-4703	19,0 cm / 6 ¹ / ₄ "	80x54 mm
1160-4704	18,5 cm / 6 ¹ / ₄ "	80x95 mm

**SAUERBRUCH**

1160-2926	25,5 cm / 10"	127x38 mm
------------------	---------------	-----------

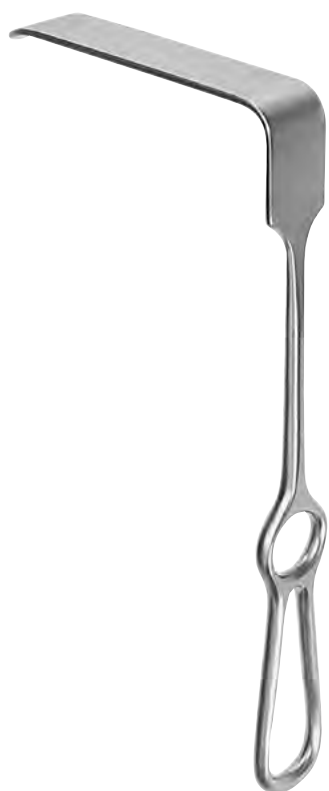
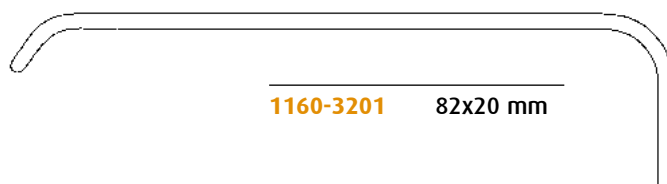
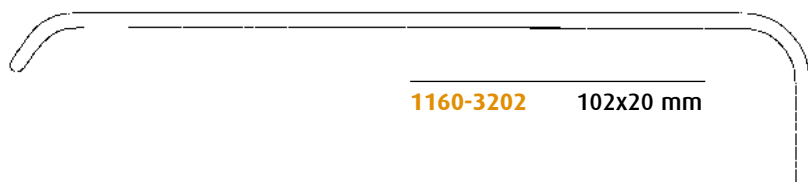
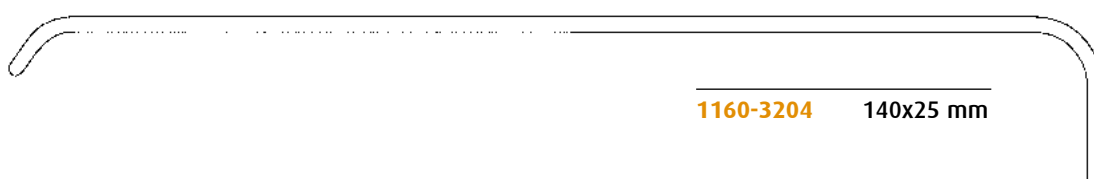
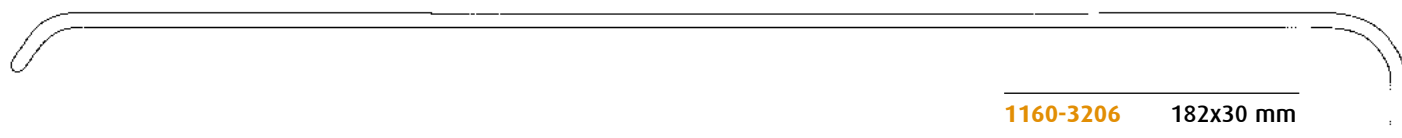

BRUNNER

1160-3201 - 1160-3206

25,0 cm / 9³/₄"

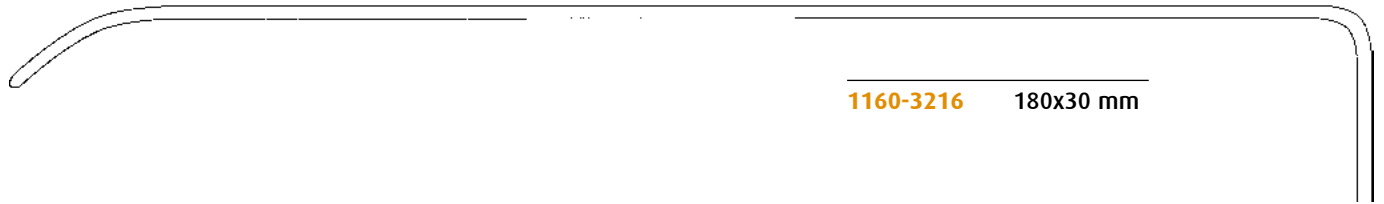

1160-3216 180x30 mm



1160-3215 160x30 mm

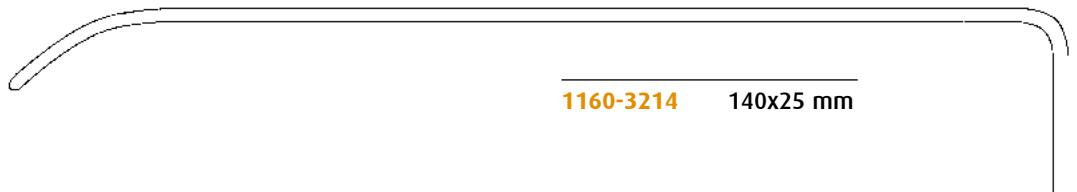

1160-3214 140x25 mm



1160-3213 120x25 mm

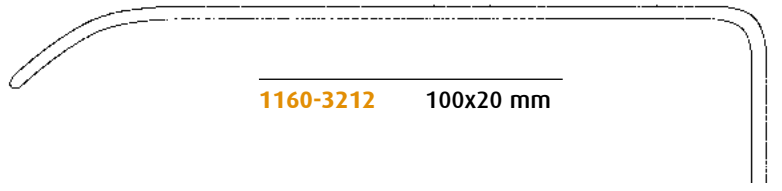

1160-3212 100x20 mm

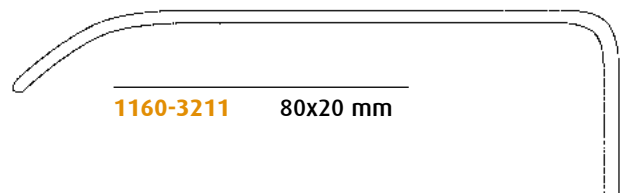

1160-3211 80x20 mm

BRUNNER

1160-3211 - 1160-3216

25,0 cm / 9³/₄"

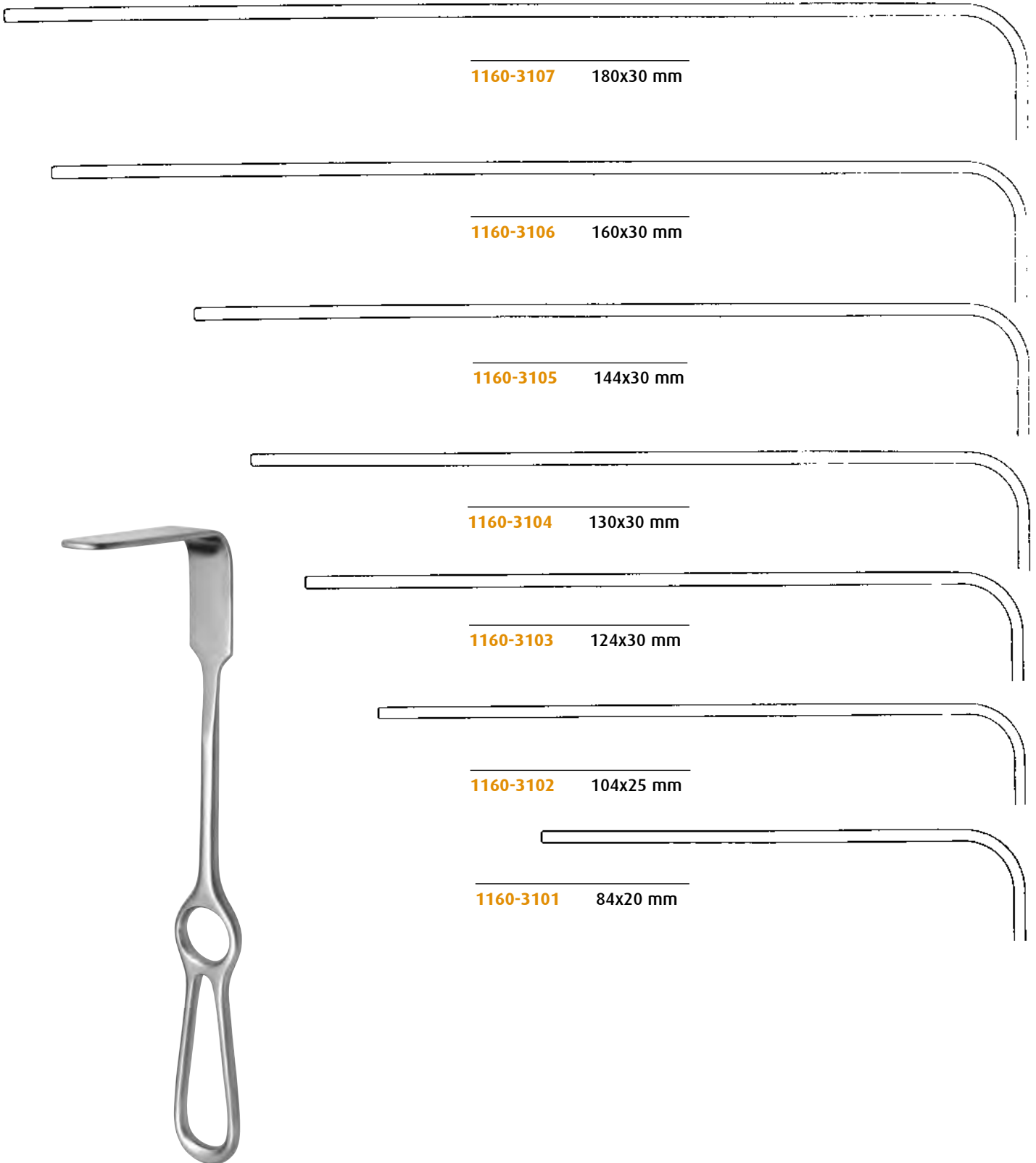

1160-3107 180x30 mm

1160-3106 160x30 mm

1160-3105 144x30 mm

1160-3104 130x30 mm

1160-3103 124x30 mm

1160-3102 104x25 mm

1160-3101 84x20 mm

BRUNNER

1160-3101 - 1160-3107

25,5 cm / 10"



1160-4607 15x15 mm

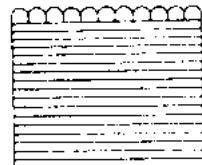

1160-4608 15x23 mm

CRAWFORD

1160-4607 - 1160-4608 19,0 cm / 7 1/2"



1312-0601 Fig. 1



1312-0602 Fig. 2



1312-0603 Fig. 3



1312-0604 Fig. 4



1312-0605 Fig. 5



1312-0606 Fig. 6

ROSS

1312-0601 - 1312-0606 25,0 cm / 9 3/4"

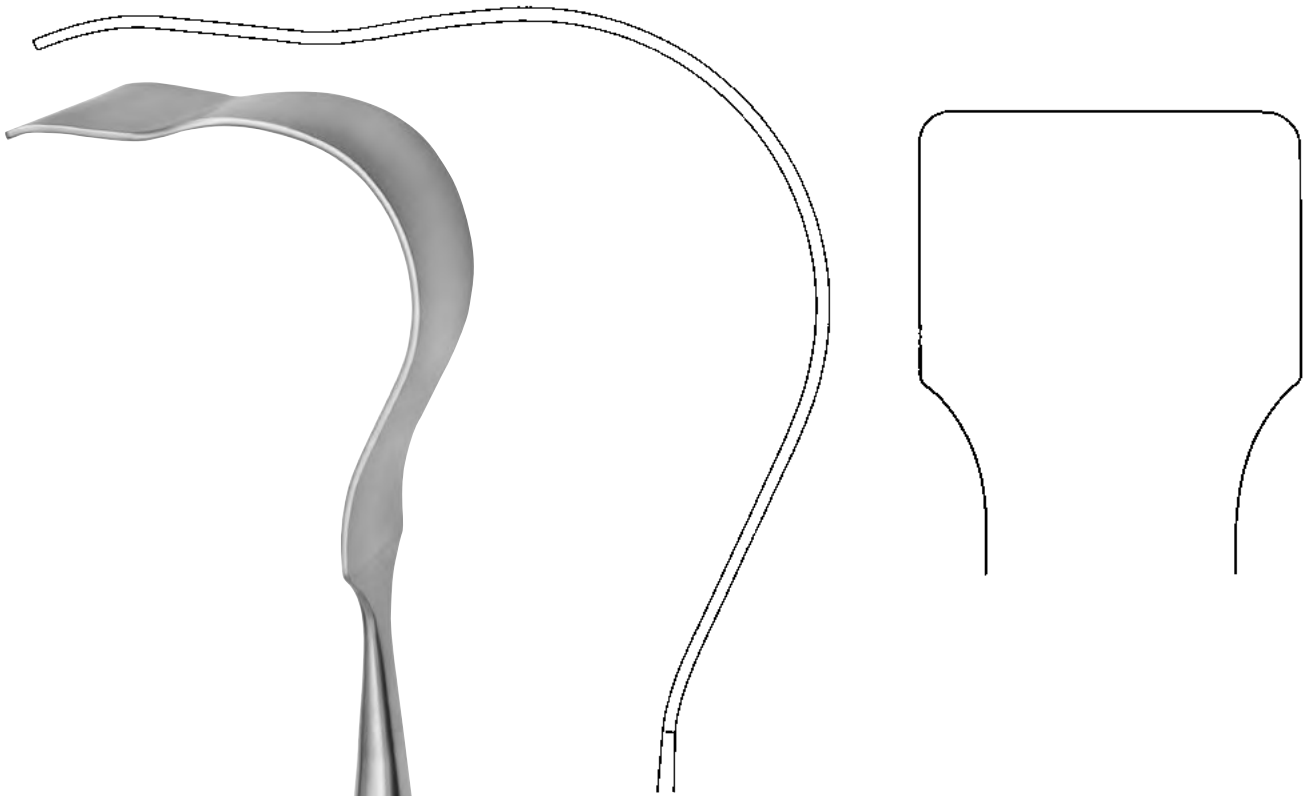

POLLOSON

1160-4605 29,0 cm / 11¹/₂"

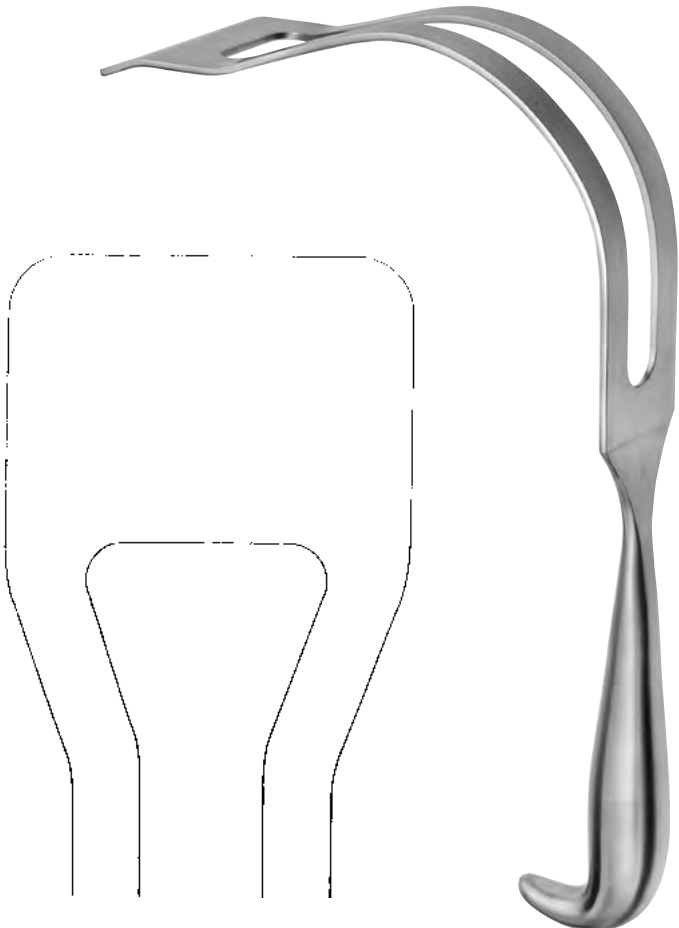

POLLOSON

1160-4606 27,0 cm / 10³/₄"

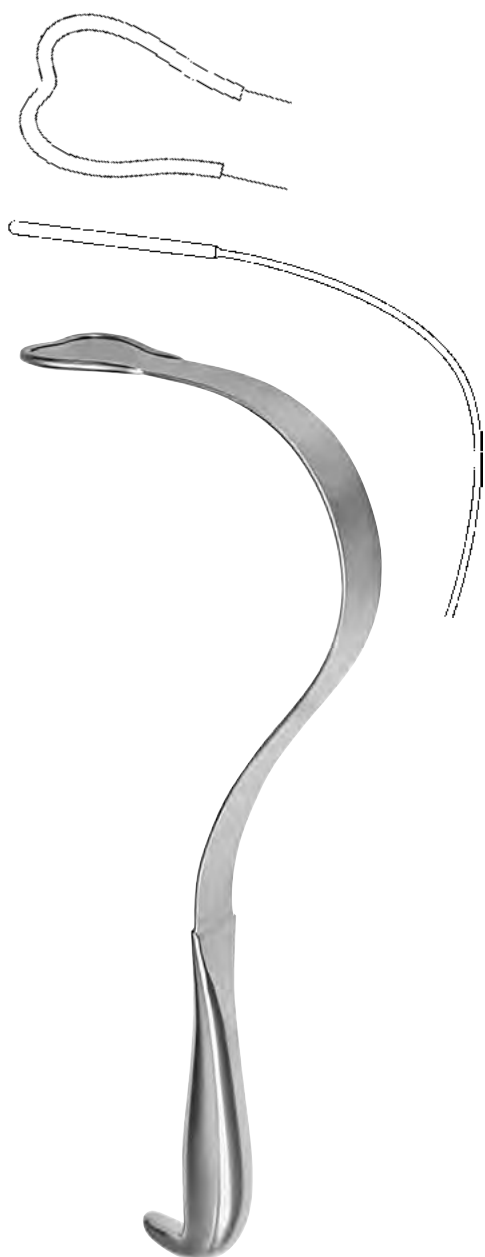
**HARRINGTON**

1160-4601	31,5 cm / 12 ¹ / ₂ "	137x44 mm
1160-4602	31,5 cm / 12 ¹ / ₂ "	137x65 mm

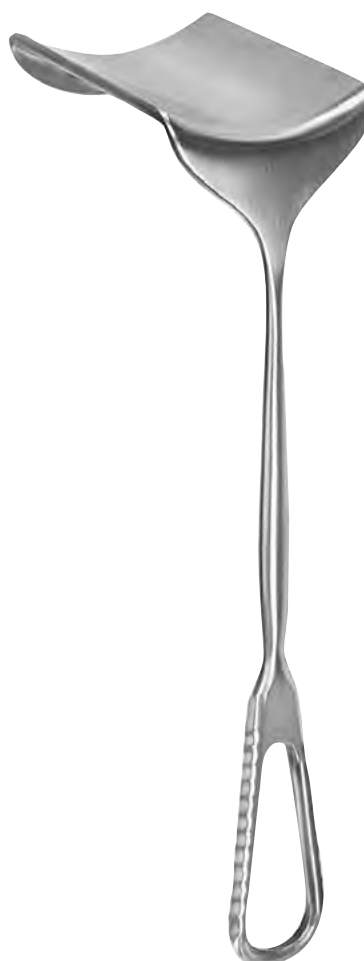
**MORRIS**

1160-3740	24,5 cm / 9 ² / ₃ "	70x40 mm
1160-3750	24,5 cm / 9 ² / ₃ "	70x50 mm
1160-3765	24,5 cm / 9 ² / ₃ "	70x65 mm



MEYERDING

1160-4311 - 1160-4313 23 cm / 8³/₄"

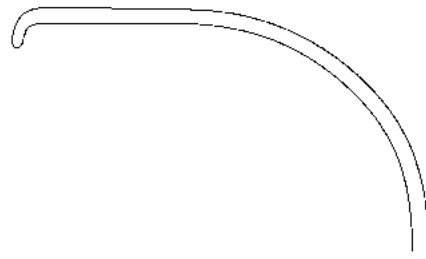

1160-4311 52x16 mm 23,0 cm

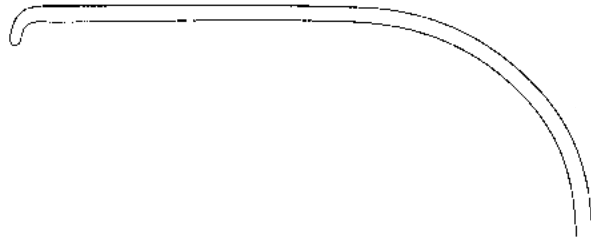

1160-4312 76x25 mm 23,0 cm

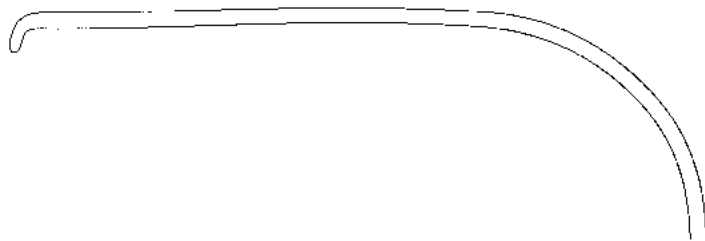

1160-4313 90x50 mm 25,5 cm



19 mm

DEAVER

1160-8101 18,0 cm / 7"



22 mm

DEAVER

1160-8102 21,5 cm / 8¹/₂"



25 mm

DEAVER

1160-8103 25,0 cm / 9³/₄"



25 mm

DEAVER
1160-8104 31,0 cm / 12¹/₄"



25 mm

DEAVER
1160-8105 33,0 cm / 13"



25 mm

DEAVER
1160-8106 36,0 cm / 14¹/₈"



38 mm

DEAVER
1160-8107 30,0 cm / 11³/₄"



50 mm

DEAVER
1160-8108 31,0 cm / 12¹/₄"



75 mm

DEAVER
1160-8109 31,5 cm / 12¹/₂"



DEAVER

1162-3725	31,5 cm / 12 ¹ / ₂ "	25 mm
1162-3738	31,5 cm / 12 ¹ / ₂ "	38 mm
1162-3750	31,5 cm / 12 ¹ / ₂ "	50 mm
1162-3775	31,0 cm / 12 ¹ / ₄ "	75 mm



48 x 48 mm
rechts
right
derecho
destra

COOLEY

1312-0024 25,0 cm / 9³/₄"



48 x 48 mm
rechts gerieft
right serrated
derecho, estriado
destra, con striatura

COOLEY

1312-0124 25,0 cm / 9³/₄"

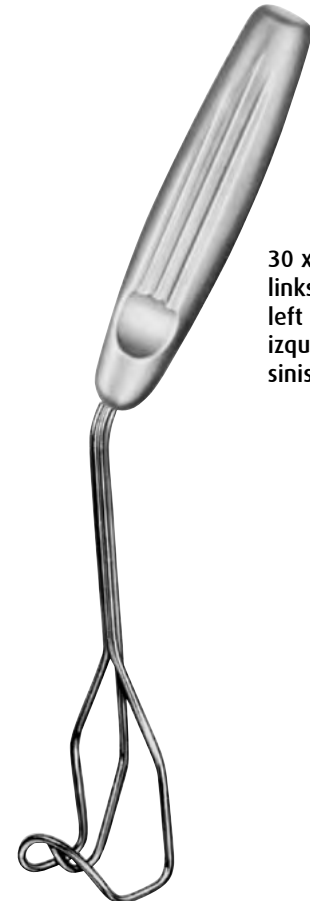

30 x 48 mm
links
left
izquierdo
sinistra

COOLEY

1312-0225 27,0 cm / 10³/₄"



MIKULICZ

1160-2802	25,0 cm / 9 ³ / ₄ "	90x35 mm
1160-2803	25,0 cm / 9 ³ / ₄ "	125 x50 mm
1160-2804	25,0 cm / 9 ³ / ₄ "	160 x50 mm

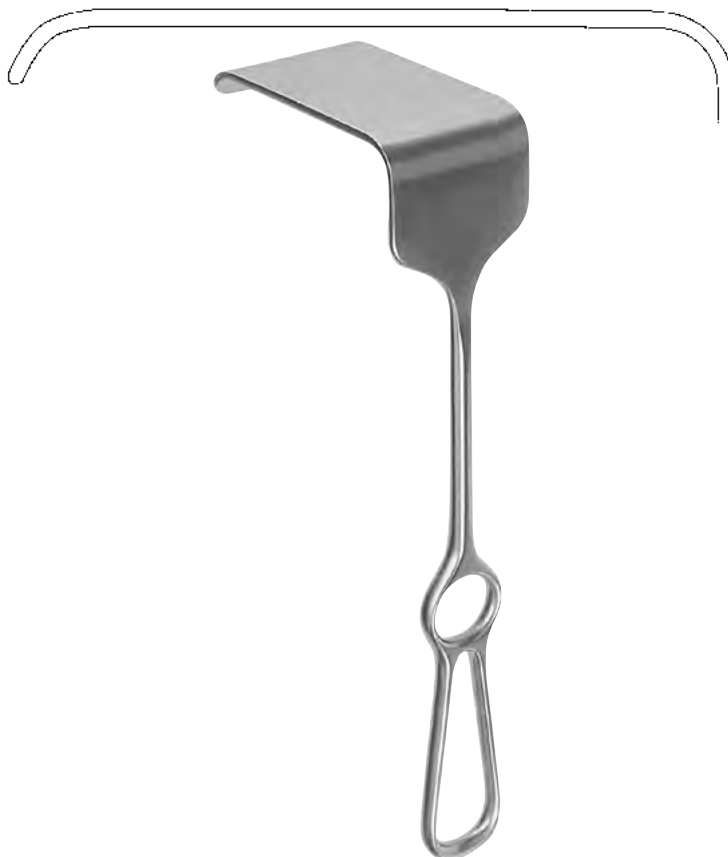

MIKULICZ

1160-2801	26,0 cm / 10 ¹ / ₄ "	90 x 55 mm
------------------	--------------------------------------------	------------



KELLY

1160-4303	27,0 cm / 10 ³ / ₄ "	160x38 mm
1160-4304	27,0 cm / 10 ³ / ₄ "	160x57 mm
1160-4301	27,0 cm / 10 ³ / ₄ "	190x38 mm
1160-4302	27,0 cm / 10 ³ / ₄ "	190x57 mm

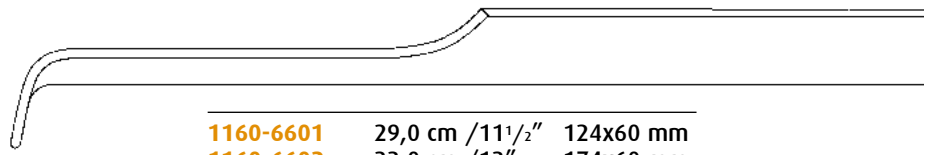

1160-6601	29,0 cm / 11 ¹ / ₂ "	124x60 mm
1160-6602	33,0 cm / 13"	174x60 mm

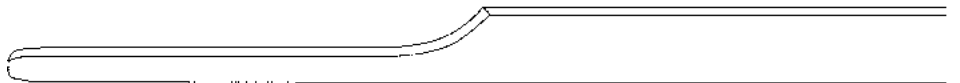

1160-6603	33,0 cm / 13"	178x60 mm
------------------	---------------	-----------

ST. MARKS

1160-6601 - 1160-6603

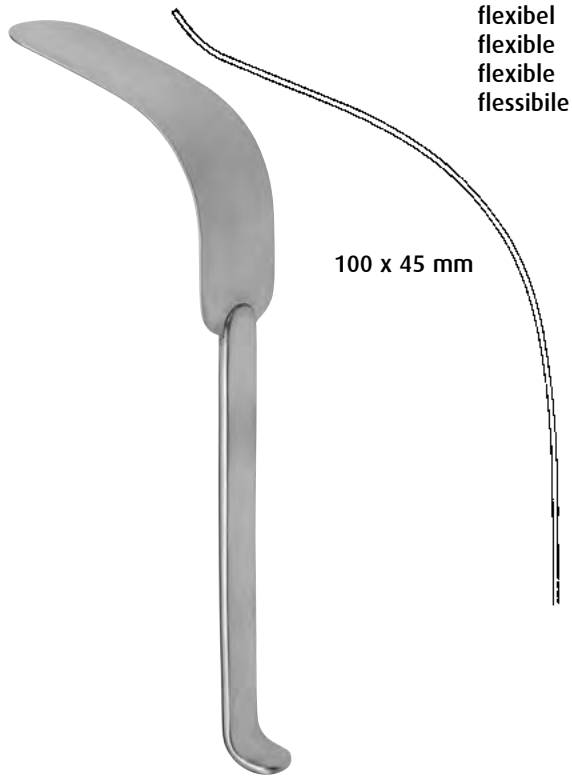

flexibel
flexible
flexible
flessibile

100 x 45 mm

KUEMMEL

1160-3728 28,0 cm / 11"

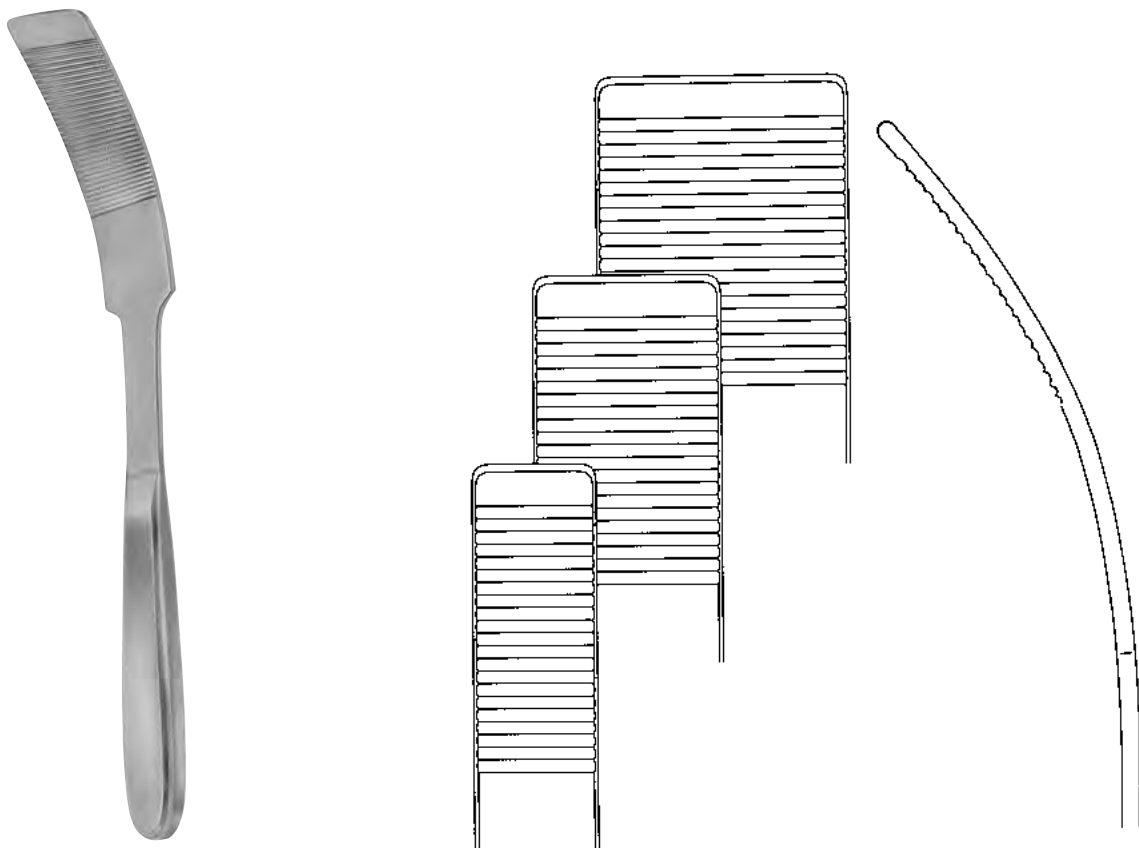

KADER

1160-7920	28,0 cm / 11"	20 mm
1160-7930	28,0 cm / 11"	30 mm
1160-7940	28,0 cm / 11"	40 mm



Fig.1 24x20 mm
Fig.2 29x26 mm
Fig.3 33x29 mm

Satz, Fig. 1-3
Set, fig. 1-3
Juego, fig. 1-3
Serie, fig. 1-3

Fig.1 30x28 mm
Fig.2 36x36 mm
Fig.3 38x43 mm

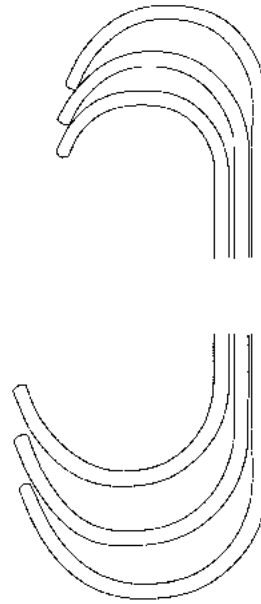

ROUX

1160-5000	17,0 cm / 6 ³ / ₄ "	Fig.1-3
1160-5001	14,0 cm / 5 ¹ / ₂ "	Fig.1
1160-5002	15,0 cm / 6"	Fig.2
1160-5003	17,0 cm / 6 ³ / ₄ "	Fig.3



Fig.2 30x10 mm
Fig.1 26x10 mm

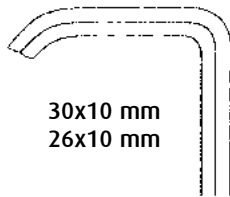
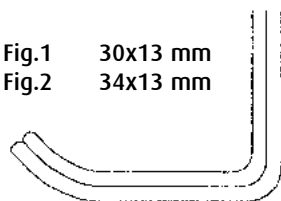

Fig.1 30x13 mm
Fig.2 34x13 mm



FARABEUF

1160-5700	11,5 cm / 4 ¹ / ₄ "	Fig.1-2
1160-5701	11,5 cm / 4 ¹ / ₄ "	Fig.1
1160-5702	11,5 cm / 4 ¹ / ₄ "	Fig.2



Fig.1 23x16 mm
Fig.2 27x16 mm

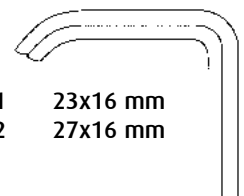
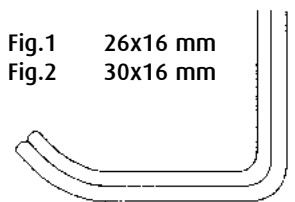

Fig.1 26x16 mm
Fig.2 30x16 mm



FARABEUF

1160-5600	15,0 cm / 6"	Fig.1-2
1160-5601	15,0 cm / 6"	Fig.1
1160-5602	15,0 cm / 6"	Fig.2



MINI-ROUX
1160-5201 14,0 cm / 5 1/2"

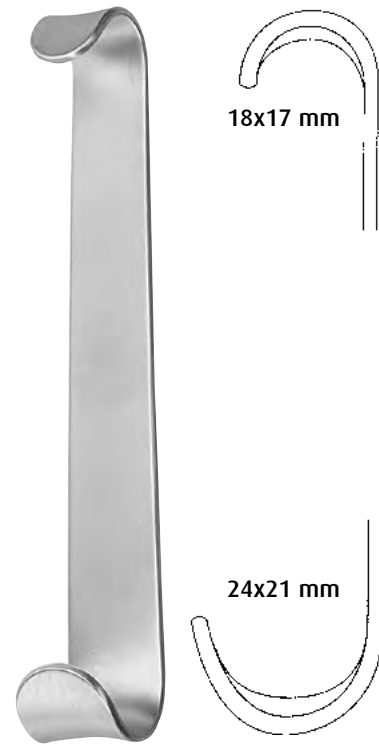

BABY-ROUX
1160-5101 13,0 cm / 5"

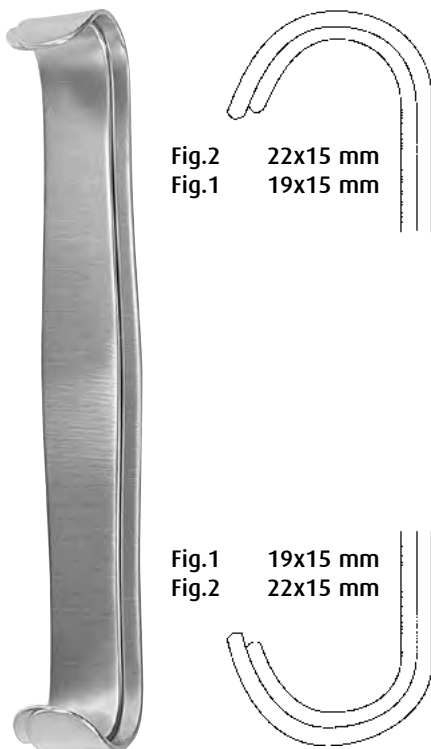

PARKER
1160-5500 13,5 cm / 5 1/4" Fig.1-2
1160-5501 13,5 cm / 5 1/4" Fig.1
1160-5502 13,5 cm / 5 1/4" Fig.2

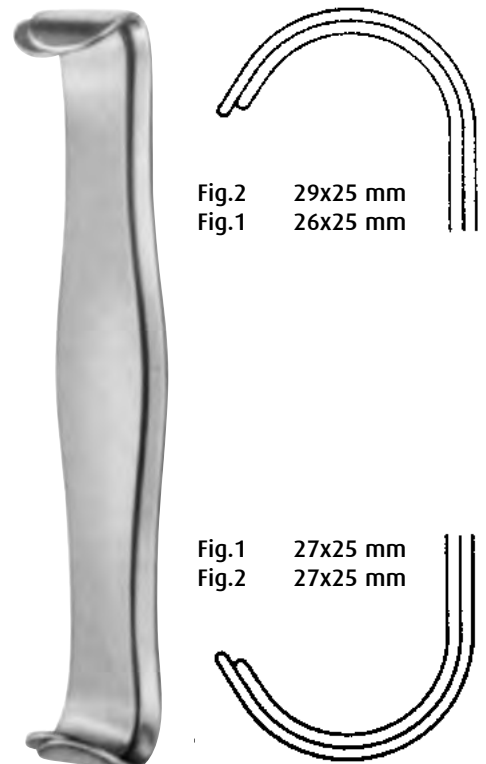

PARKER
1160-5400 17,5 cm / 7" Fig.1-2
1160-5401 17,5 cm / 7" Fig.1
1160-5402 17,5 cm / 7" Fig.2

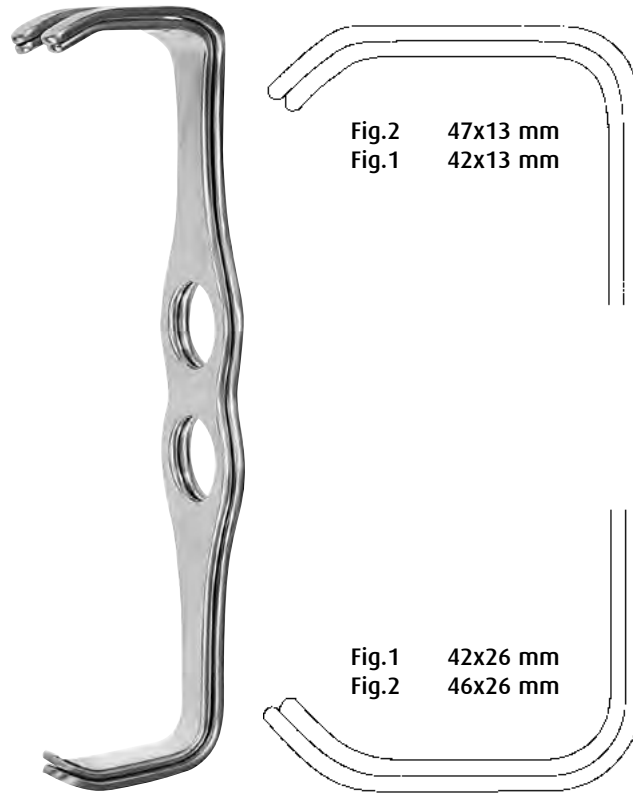

Fig.2 47x13 mm
Fig.1 42x13 mm

Fig.1 42x26 mm
Fig.2 46x26 mm

MATHIEU

- | | | |
|------------------|--------------|---------|
| 1160-5900 | 20,0 cm / 8" | Fig.1-2 |
| 1160-3701 | 20,0 cm / 8" | Fig.1 |
| 1160-3702 | 20,0 cm / 8" | Fig.2 |



40x40 mm

30x30 mm

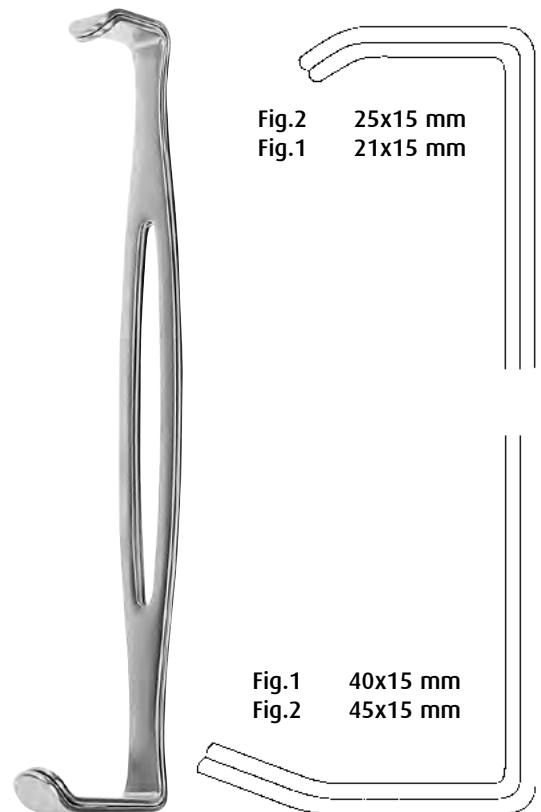

Fig.2 25x15 mm
Fig.1 21x15 mm

Fig.1 40x15 mm
Fig.2 45x15 mm

GOELET

- | | |
|------------------|---------------|
| 1160-6119 | 19,0 cm / 7½" |
|------------------|---------------|

PARKER-LANGENBECK

- | | | |
|------------------|---------------|---------|
| 1160-5800 | 21,5 cm / 8½" | Fig.1-2 |
| 1160-5801 | 21,5 cm / 8½" | Fig.1 |
| 1160-5802 | 21,5 cm / 8½" | Fig.2 |

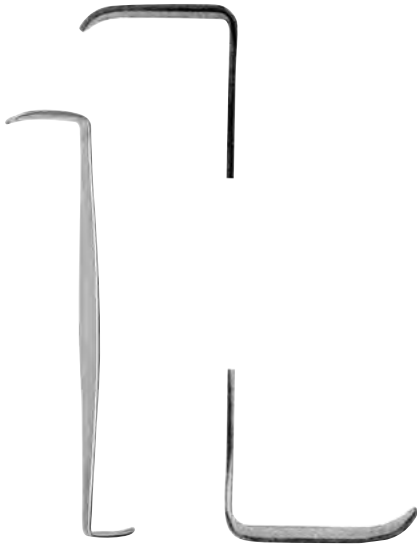
**CRILE****1160-6011** 11,0 cm / 4¹/₄"**LUER****1160-6210** 11,0 cm / 4¹/₄"**COLLIN****1160-6300** 14,5 cm / 5³/₄"

Bauchspatel
Abdominal Spatulas
Espátulas abdominales
Spatole addominali

016



REVERDIN

1165-3790 29,0 cm / 11½"



REVERDIN

1160-7128 28,5 cm / 11"



biegsam
malleable
maleable
malleabile

RIBBON

1160-7203 330x30 mm
1160-7204 330x40 mm
1160-7205 330x50 mm



biegsam
malleable
maleable
malleabile

HABERER

1160-7301 200x17/25 mm
1160-7302 280x25/30 mm
1160-7304 300x37/45 mm



biegsam
malleable
maleable
malleabile

RIBBON

1160-7404 200x12 mm
1160-7405 200x17 mm
1160-7406 250x25 mm



FINSEN

1162-0305 - 1162-0405
1162-0307 - 1162-0407

1162-0305

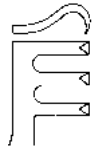

scharf
sharp
agudo
acuto

1162-0405

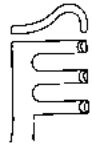

stumpf
blunt
romo
smusso

1162-0307

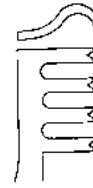

scharf
sharp
agudo
acuto

1162-0407

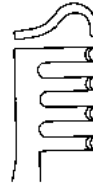

stumpf
blunt
romo
smusso



FINSEN

1162-0607 - 1162-0707

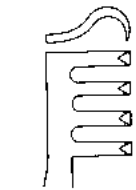

1162-0607

scharf
sharp
agudo
acuto

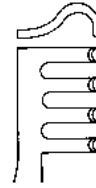

1162-0707

stumpf
blunt
romo
smusso

7,0 cm / 2³/₄"

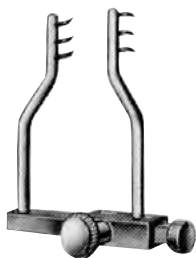

LOGAN

1166-3704 4,0 cm / 1¹/₂"



scharf
sharp
agudo
acuto



scharf
sharp
agudo
acuto

BUCKLEY

1168-3706 6,0 cm / 2¹/₄"

Wundspreizer
Self-Retaining Retractors
Separadores autoestáticos
Divaricatori autostatici



ALM

1162-1207 - 1162-1307
 1162-1210 - 1162-1310

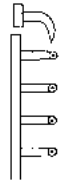

scharf
 sharp
 agudo
 acuto

1162-1207
 1162-1307

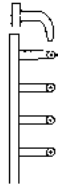

stumpf
 blunt
 romo
 smusso

1162-1210
 1162-1310

7,0 cm / 2³/₄"
 10,0 cm / 4"



ALLPORT

1162-3795 9,5 cm / 3³/₄"



HOLZHEIMER

1162-0910 - 1162-1010

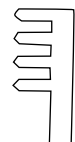

scharf
 sharp
 agudo
 acuto

1162-0910

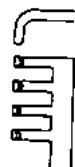

stumpf
 blunt
 romo
 smusso

1162-1010

10,0 cm / 4"



JANSEN

1162-1406 - 1162-1506

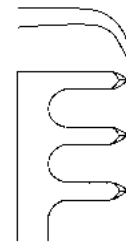

scharf
 sharp
 agudo
 acuto

1162-1406

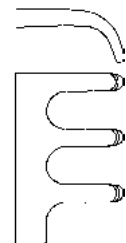

stumpf
 blunt
 romo
 smusso

1162-1506

10,0 cm / 4"

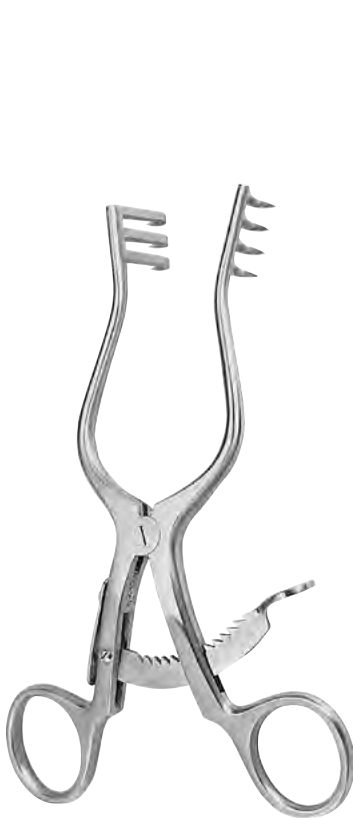

scharf
sharp
agudo
acuto

1162-1614



stumpf
blunt
romo
smusso

1162-1615

SCALP-CONTOUR

1162-1614 - 1162-1615

14,0 cm / 5 1/2"

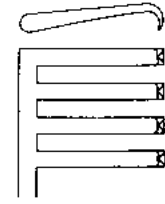

scharf
sharp
agudo
acuto

ANDERSON-ADSON

1162-4120

20,0 cm / 8"

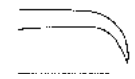

scharf
sharp
agudo
acuto

1162-4607

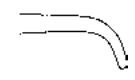

stumpf
blunt
romo
smusso

1162-4707

ADSON

1162-4607 - 1162-4707

26,5 cm / 10 1/2"



scharf
sharp
agudo
acuto

1162-1710



stumpf
blunt
romo
smusso

1162-1810

WEITLANER-LOKTITE

1162-1710 - 1162-1810

10,5 cm / 4 1/8"

Wundspreizer
Self-Retaining Retractors
Separadores autoestáticos
Divaricatori autostatici



scharf
sharp
agudo
acuto

1162-1714



stumpf
blunt
romo
smusso

1162-1813

WEITLANER

1162-1714 - 1162-1813

13,0 cm / 5 1/8"



scharf
sharp
agudo
acuto

1162-1716



stumpf
blunt
romo
smusso

1162-1816

WEITLANER

1162-1716 - 1162-1816

16,0 cm / 6 1/4"



scharf
sharp
agudo
acuto

1162-4320



stumpf
blunt
romo
smusso

1162-4420

WEITLANER

1162-4320 - 1162-4420

20,0 cm / 8"



scharf
sharp
agudo
acuto

1162-4324



stumpf
blunt
romo
smusso

1162-4424

WEITLANER

1162-4324 - 1162-4424

24,0 cm / 9 1/2"

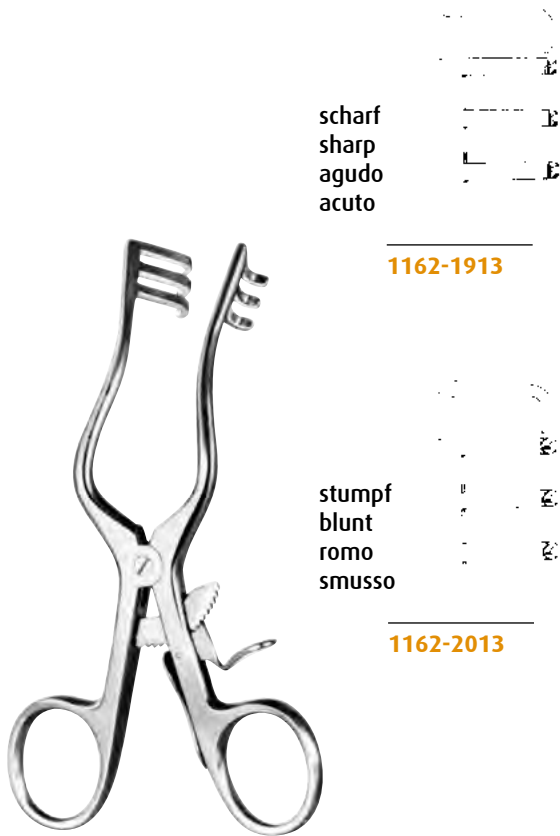

scharf
 sharp
 agudo
 acuto

1162-1913

stumpf
 blunt
 romo
 smusso

1162-2013

WEITLANER-WULLSTEIN

1162-1913 - 1162-2013

13,0 cm / 5"

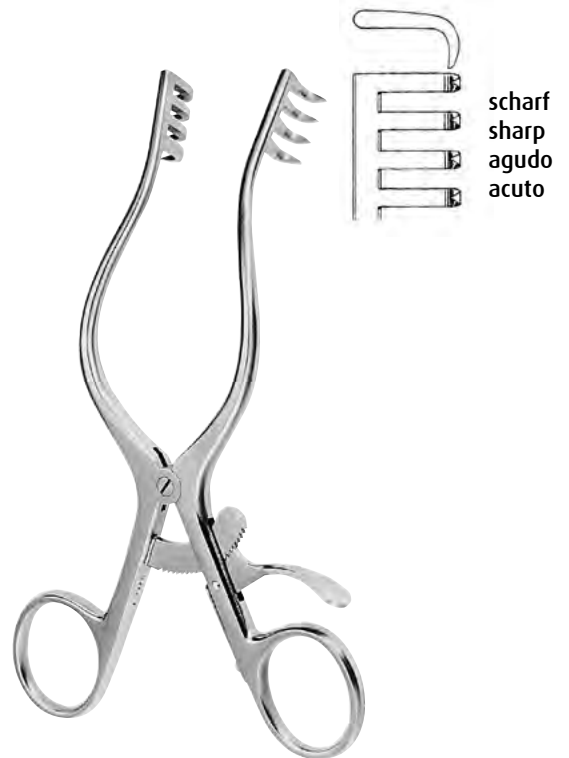

scharf
 sharp
 agudo
 acuto

MOLLISON

1162-2115

15,5 cm / 6"

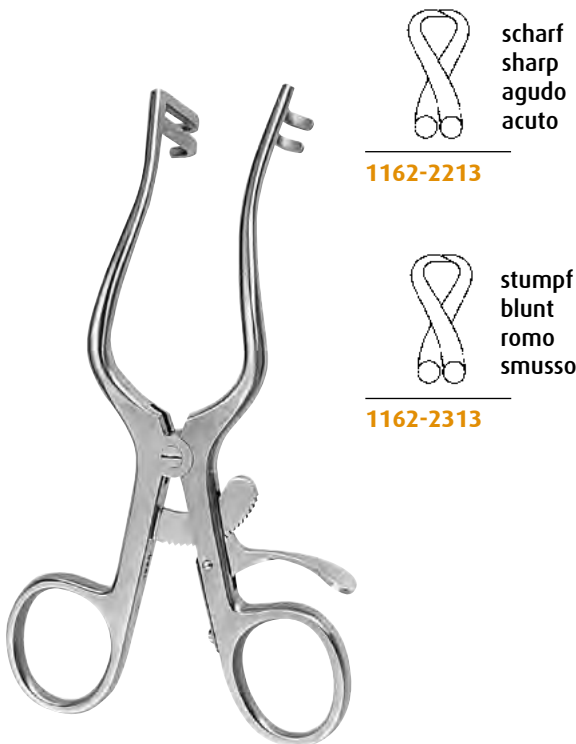

scharf
 sharp
 agudo
 acuto

1162-2213

stumpf
 blunt
 romo
 smusso

1162-2313

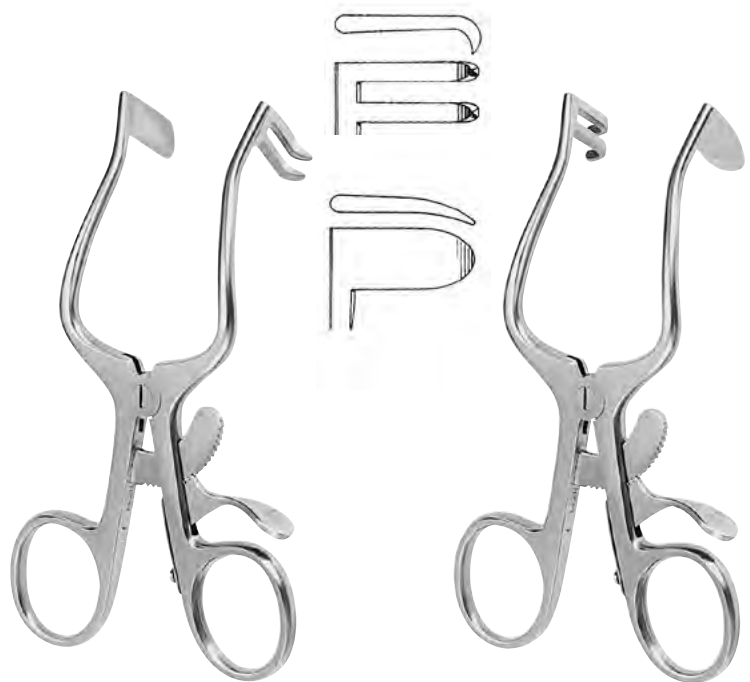

PLESTER

1162-2213 - 1162-2313

13,0 cm / 5"

PLESTER

1162-2411

11,0 cm / 4³/₈"

PLESTER

1162-2511

11,0 cm / 4³/₈"

Wundspreizer
Self-Retaining Retractors
Separadores autoestáticos
Divaricatori autostatici

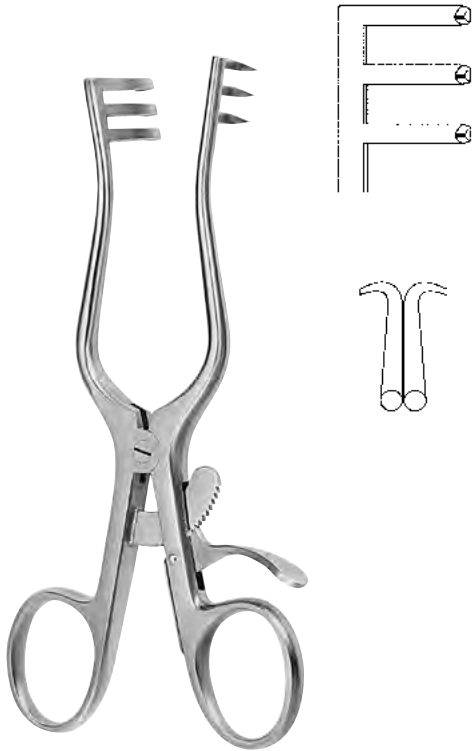

stumpf
 blunt
 romo
 smusso

MILLIGAN

1162-2813 13,0 cm / 5"

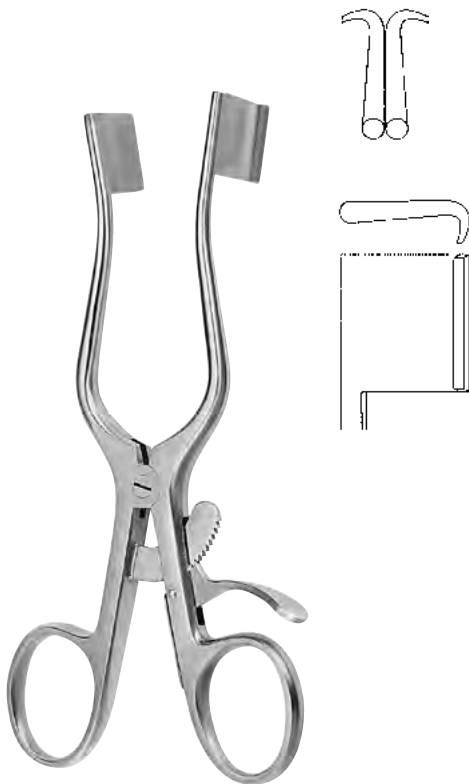

WEITLANER-BABY

1162-3013 13,0 cm / 5"



scharf
 sharp
 agudo
 acuto
1164-3725

stumpf
 blunt
 romo
 smusso
1165-3725

SCHUKNECHT

1164-3725 - 1165-3725 12,5 cm / 5"

scharf
sharp
agudo
acuto

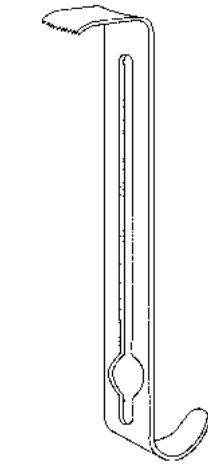

1162-3619 19x16 mm

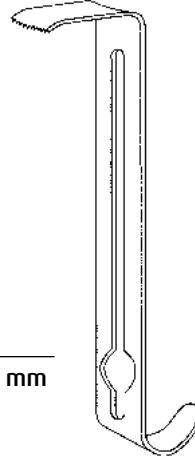

1162-3625 25x16 mm

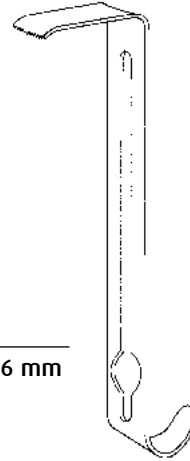

1162-3632 32x16 mm

stumpf
blunt
romo
smusso



HENLEY

1162-3400 16,0 cm / 6¹/₄"

HENLEY

1162-3500 16,0 cm / 6¹/₄"

HENLEY

1162-3400

komplett, bestehend aus:

- 1 Sperrer mit Seitenvalven, scharf (1162-3401)
- 1 Mittelvalve 19 x 16 mm (1162-3619)
- 1 Mittelvalve 25 x 16 mm (1162-3625)
- 1 Mittelvalve 32 x 16 mm (1162-3632)

complete, consisting of:

- 1 Spreader with lateral valves, sharp (1162-3401)
- 1 Central valve 19 x 16 mm (1162-3619)
- 1 Central valve 25 x 16 mm (1162-3625)
- 1 Central valve 32 x 16 mm (1162-3632)

completo, compuesto de:

- 1 Separador con valvas laterales, agudas (1162-3401)
- 1 Valva central 19 x 16 mm (1162-3619)
- 1 Valva central 25 x 16 mm (1162-3625)
- 1 Valva central 32 x 16 mm (1162-3632)

completo, composto da:

- 1 Divaricatore con valve laterali, acuto (1162-3401)
- 1 Valva centrale 19 x 16 mm (1162-3619)
- 1 Valva centrale 25 x 16 mm (1162-3625)
- 1 Valva centrale 32 x 16 mm (1162-3632)

HENLEY

1162-3500

komplett bestehend aus:

- 1 Sperrer mit Seitenvalven, stumpf (1162-3501)
- 1 Mittelvalve 19 x 16 mm (1162-3619)
- 1 Mittelvalve 25 x 16 mm (1162-3625)
- 1 Mittelvalve 32 x 16 mm (1162-3632)

complete consisting of:

- 1 Spreader with lateral valves, blunt (1162-3501)
- 1 Central valve 19 x 16 mm (1162-3619)
- 1 Central valve 25 x 16 mm (1162-3625)
- 1 Central valve 32 x 16 mm (1162-3632)

completo, compuesto de:

- 1 Separador con valvas laterales, romas (1162-3501)
- 1 Valva central 19 x 16 mm (1162-3619)
- 1 Valva central 25 x 16 mm (1162-3625)
- 1 Valva central 32 x 16 mm (1162-3632)

completo, composto da:

- 1 Divaricatore con valve laterali, smusso (1162-3501)
- 1 Valva centrale 19 x 16 mm (1162-3619)
- 1 Valva centrale 25 x 16 mm (1162-3625)
- 1 Valva centrale 32 x 16 mm (1162-3632)



scharf
sharp
agudo
acuto

ADSON

1162-5213 13,5 cm / 5¹/₄"
1162-5216 16,5 cm / 6¹/₂"



stumpf
blunt
romo
smusso

ADSON

1162-5313 13,5 cm / 5¹/₄"
1162-5316 16,5 cm / 6¹/₂"

scharf
sharp
agudo
acuto



ADSON

1162-5220 20,0 cm / 8"
1162-5226 26,0 cm / 10¹/₄"

stumpf
blunt
romo
smusso



ADSON

1162-5320 20,0 cm / 8"
1162-5326 26,0 cm / 10¹/₄"

Wundspreizer
Self-Retaining Retractors
Separadores autoestáticos
Divaricatori autostatici

016

scharf
sharp
agudo
acuto

stumpf
blunt
romo
smusso

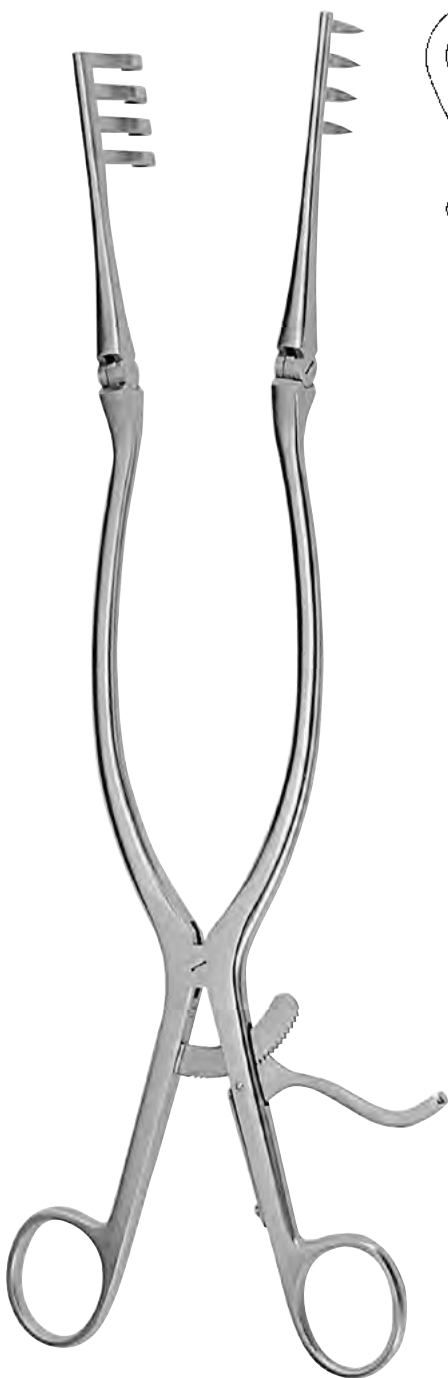

BECKMANN

1162-5531 32,0 cm / 12½"

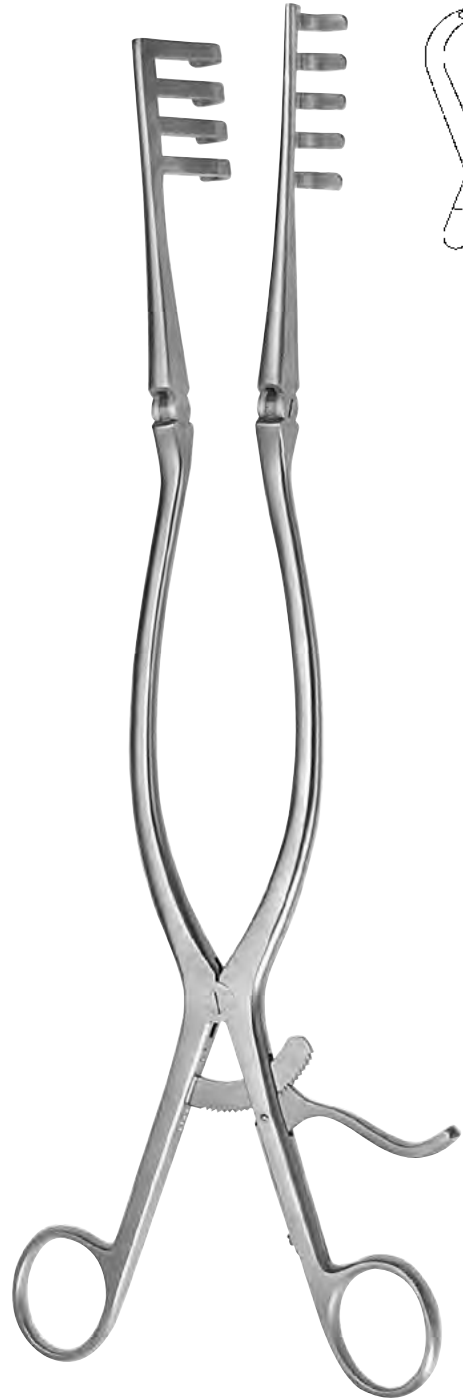
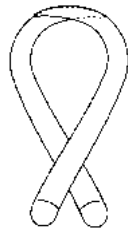

ADSON

1162-5832 33,0 cm / 13"

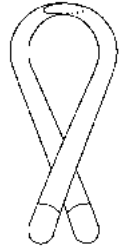



BECKMANN-EATON

1162-6132 32,0 cm / 12¹/₂"



BECKMANN-ADSON

1162-5901 - 1162-6002 30,5 cm / 12¹/₄"

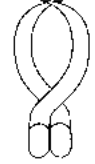

scharf
sharp
agudo
acuto

1162-5901 25x25 mm
1162-6001 25x45 mm

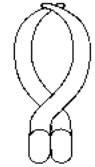

stumpf
blunt
romo
smusso

1162-5902 25x25 mm
1162-6002 25x45 mm



NORFOLK AND NORWICH

1162-4022 22,0 cm / 8³/₄"

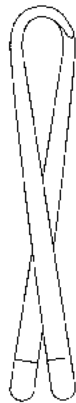

RICHTER

1162-3917 17,0 cm / 6³/₄"



MAYO-ADAMS

1162-3217 16,5 cm / 6 $\frac{1}{2}$ "



RIGBY

1162-5118 18,0 cm / 7"



JOLL (FRIEDMAN)

1350-9700 15,5 cm / 6"

Wundspreizer
Self-Retaining Retractors
Separadores autoestáticos
Divaricatori autostatici

016



GELPI

1162-4809 9,0 cm / 3 1/2"
1162-4811 11,0 cm / 4 3/8"



GELPI

1162-4813 13,0 cm / 5 3/8"



GELPI

1162-4816 16,0 cm / 6 1/4"
1162-4818 18,0 cm / 7"



GELPI-LOKTITE

1162-4918 18,0 cm / 7"



1203-6202 40x15-23 mm (axb)



1203-6203 45x15-23 mm (axb)



1203-6204 50x15-23 mm (axb)



1203-6205 55x15-23 mm (axb)



1203-6206 60x15-23 mm (axb)

CLOWARD

1203-6000

Wundspreizer, komplett, bestehend aus:

- 1 Sperrer (1203-6001)
- 2 gezahnten Seitenvalven 40x15 - 23 mm (1203-6202)
- 2 gezahnten Seitenvalven 45x15 - 23 mm (1203-6203)
- 2 gezahnten Seitenvalven 50x15 - 23 mm (1203-6204)
- 2 gezahnten Seitenvalven 55x15 - 23 mm (1203-6205)
- 2 gezahnten Seitenvalven 60x15 - 23 mm (1203-6206)

Self-retaining retractor, complete, consisting of:

- 1 Spreader (1203-6001)
- 2 Lateral valves, serrated, 40x15 - 23 mm (1203-6202)
- 2 Lateral valves, serrated, 45x15 - 23 mm (1203-6203)
- 2 Lateral valves, serrated, 50x15 - 23 mm (1203-6204)
- 2 Lateral valves, serrated, 55x15 - 23 mm (1203-6205)
- 2 Lateral valves, serrated, 60x15 - 23 mm (1203-6206)

Separador, completo, compuesto de:

- 1 Separador (1203-6001)
- 2 Valvas laterales, dentadas, 40x15 - 23 mm (1203-6202)
- 2 Valvas laterales, dentadas, 45x15 - 23 mm (1203-6203)
- 2 Valvas laterales, dentadas, 50x15 - 23 mm (1203-6204)
- 2 Valvas laterales, dentadas, 55x15 - 23 mm (1203-6205)
- 2 Valvas laterales, dentadas, 60x15 - 23 mm (1203-6206)

Divaricatore, completo, composto da:

- 1 Divaricatore (1203-6001)
- 2 Valve laterale, dentellata, 40x15 - 23 mm (1203-6202)
- 2 Valve laterale, dentellata, 45x15 - 23 mm (1203-6203)
- 2 Valve laterale, dentellata, 50x15 - 23 mm (1203-6204)
- 2 Valve laterale, dentellata, 55x15 - 23 mm (1203-6205)
- 2 Valve laterale, dentellata, 60x15 - 23 mm (1203-6206)



CLOWARD

1203-6001 25,0 cm / 9³/₄"

Wundspreizer für die cervicale Wirbelsäule
Retractors for cervical spine
Separadores para la columna cervical
Divaricatori per colonna cervicale

016

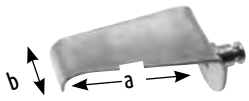

1203-6212 40x15-23 mm (axb)



1203-6213 45x15-23 mm (axb)



1203-6214 50x15-23 mm (axb)



1203-6215 55x15-23 mm (axb)



1203-6216 60x15-23 mm (axb)

CLOWARD

1203-6200

Wundspreizer, komplett, bestehend aus:

- 1 Sperrer (1203-6201)
- 2 stumpfen Seitenvalven 40x15 - 23 mm (1203-6212)
- 2 stumpfen Seitenvalven 45x15 - 23 mm (1203-6213)
- 2 stumpfen Seitenvalven 50x15 - 23 mm (1203-6214)
- 2 stumpfen Seitenvalven 55x15 - 23 mm (1203-6215)
- 2 stumpfen Seitenvalven 60x15 - 23 mm (1203-6216)

Self-retaining retractor, complete, consisting of:

- 1 Spreader (1203-6201)
- 2 Lateral valves, blunt, 40x15 - 23 mm (1203-6212)
- 2 Lateral valves, blunt, 45x15 - 23 mm (1203-6213)
- 2 Lateral valves, blunt, 50x15 - 23 mm (1203-6214)
- 2 Lateral valves, blunt, 55x15 - 23 mm (1203-6215)
- 2 Lateral valves, blunt, 60x15 - 23 mm (1203-6216)

Separador, completo, compuesto de:

- 1 Separador (1203-6201)
- 2 Valvas laterales, romas, 40x15 - 23 mm (1203-6212)
- 2 Valvas laterales, romas, 45x15 - 23 mm (1203-6213)
- 2 Valvas laterales, romas, 50x15 - 23 mm (1203-6214)
- 2 Valvas laterales, romas, 55x15 - 23 mm (1203-6215)
- 2 Valvas laterales, romas, 60x15 - 23 mm (1203-6216)

Divaricatore, completo, composto da:

- 1 Divaricatore (1203-6201)
- 2 Valve laterale, smussa, 40x15 - 23 mm (1203-6212)
- 2 Valve laterale, smussa, 45x15 - 23 mm (1203-6213)
- 2 Valve laterale, smussa, 50x15 - 23 mm (1203-6214)
- 2 Valve laterale, smussa, 55x15 - 23 mm (1203-6215)
- 2 Valve laterale, smussa, 60x15 - 23 mm (1203-6216)



CLOWARD

1203-6201 15,0 cm /6"



BABY-COLLIN
1162-6700 18,0 cm / 7"



COLLIN
1162-7000 22,5 cm / 9"



COLLIN
1162-7001 22,5 cm / 9 1/4"

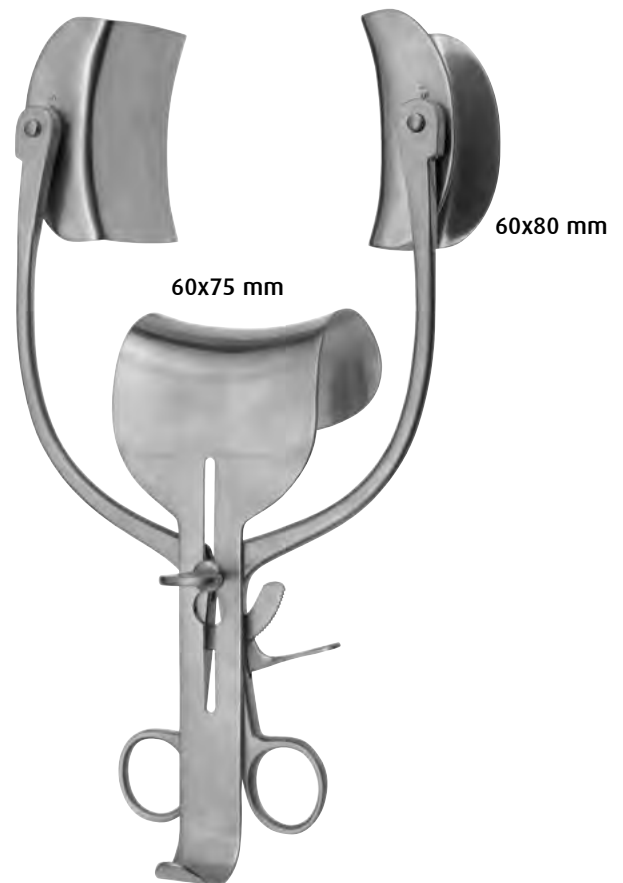

COLLIN-LOKTITE
1162-7101 31,0 cm / 12 1/4"

Wundspreizer, Bauchdeckenhalter
Self-Retaining Retractors, Abdominal Retractors
Separadores autoestáticos, Separadores abdominales
Divaricatori autostatici, Divaricatori addominali

016

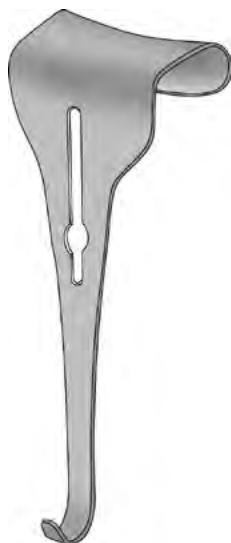

COLLIN

- 1166-3755 55x55 mm
- 1166-3765 55x65 mm
- 1166-3775 55x75 mm

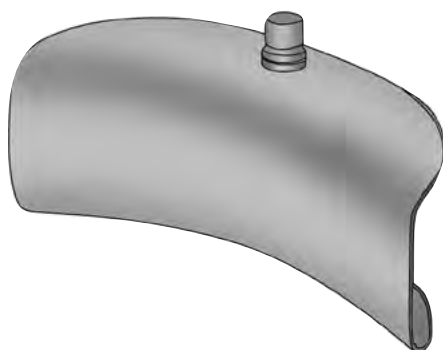

- 1168-3701 32x 62 mm
- 1168-3702 38x 80 mm
- 1168-3703 38x100 mm

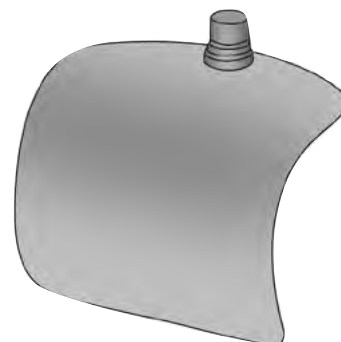

- 1162-7392 60x80 mm



RICARD

- 1162-7204 55x70 mm
- 1162-7205 90x80 mm



- 1162-7210 50x58 mm
- 1162-7202 60x80 mm
- 1162-7203 72x85 mm

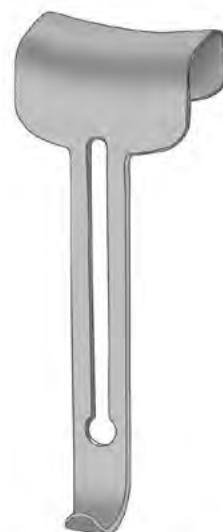

ROBIN-MASSE

- 1161-3701 40x64 mm

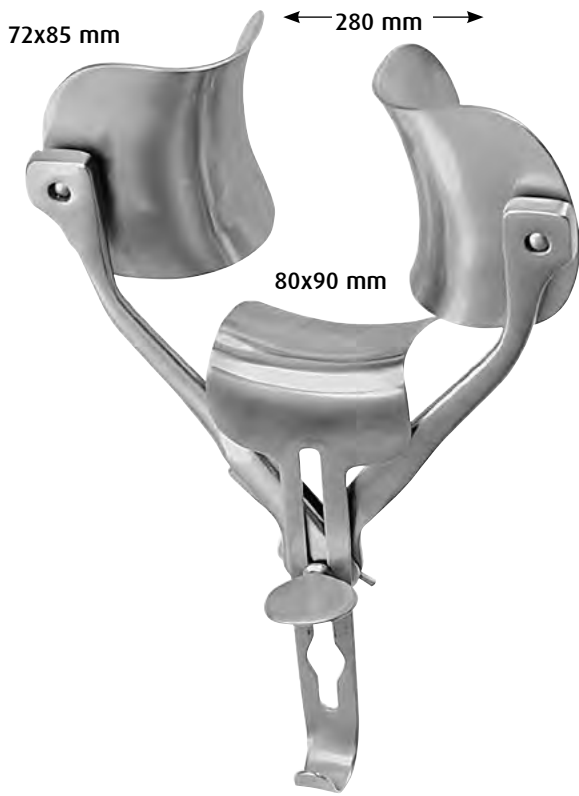

RICARD
 1160-3780 28,0 cm / 11"

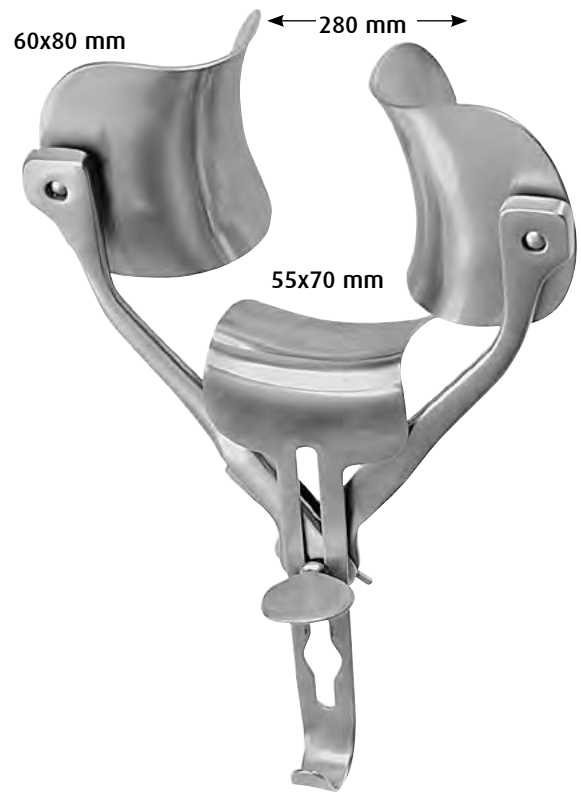

RICARD
 1162-7300 30,0 cm / 12"

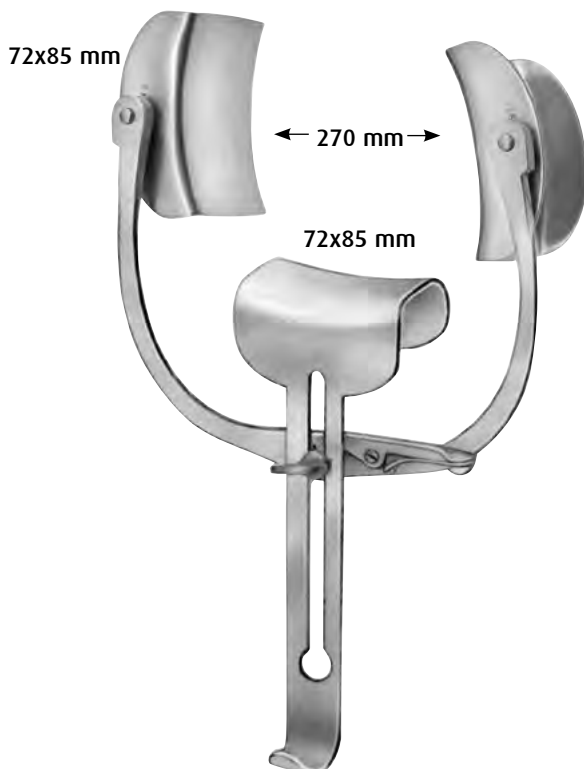

ROBIN-MASSE
 1160-3770

Bauchdeckenhalter
Abdominal Retractors
Separadores abdominales
Divaricatori addominali

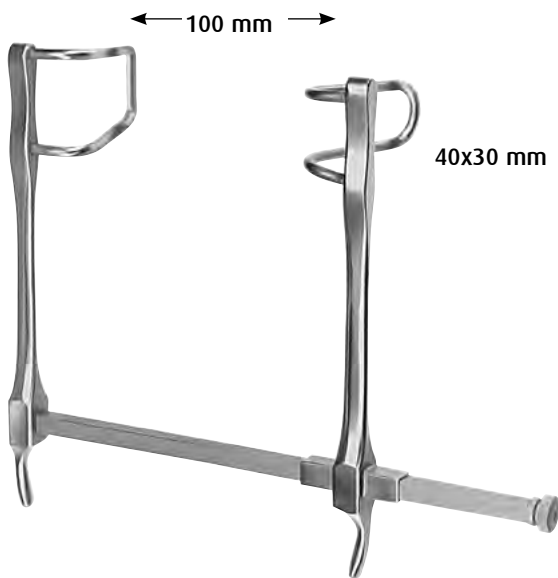

GOSSET
1162-7410

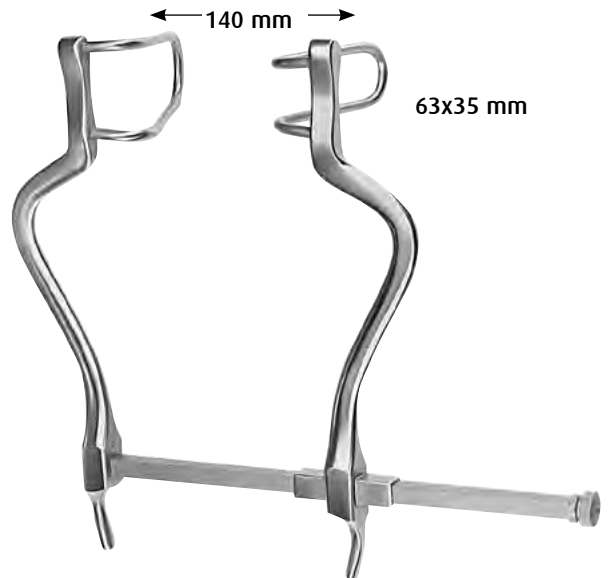

GOSSET
1162-7414

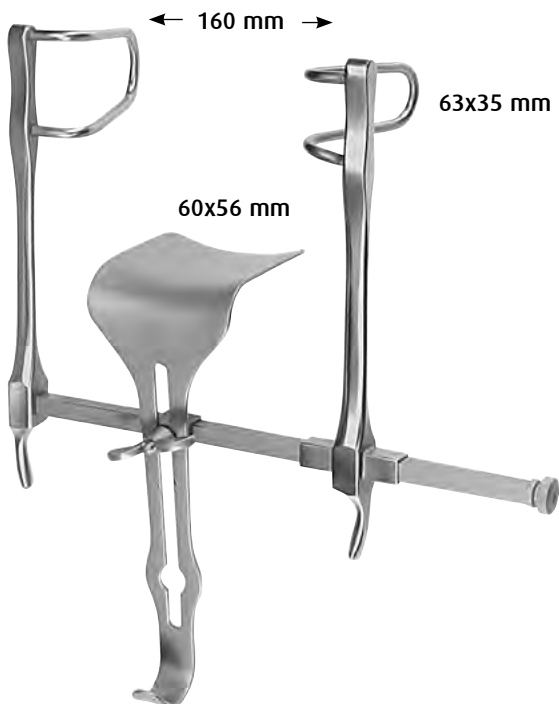

GOSSET
1162-7518

1161-3760 60x56 mm
Mittelvalve
Central blade
Valva central
Valva centrale

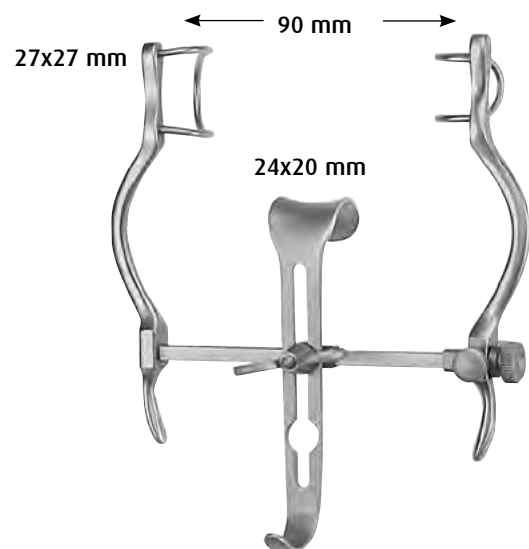

BABY-BALFOUR
1162-7600

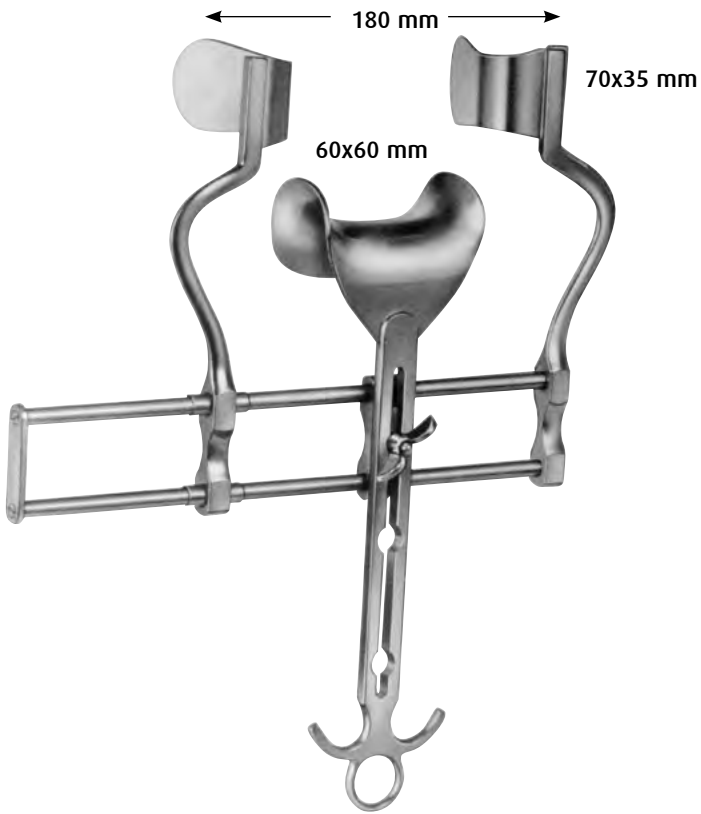

BALFOUR
1162-7818

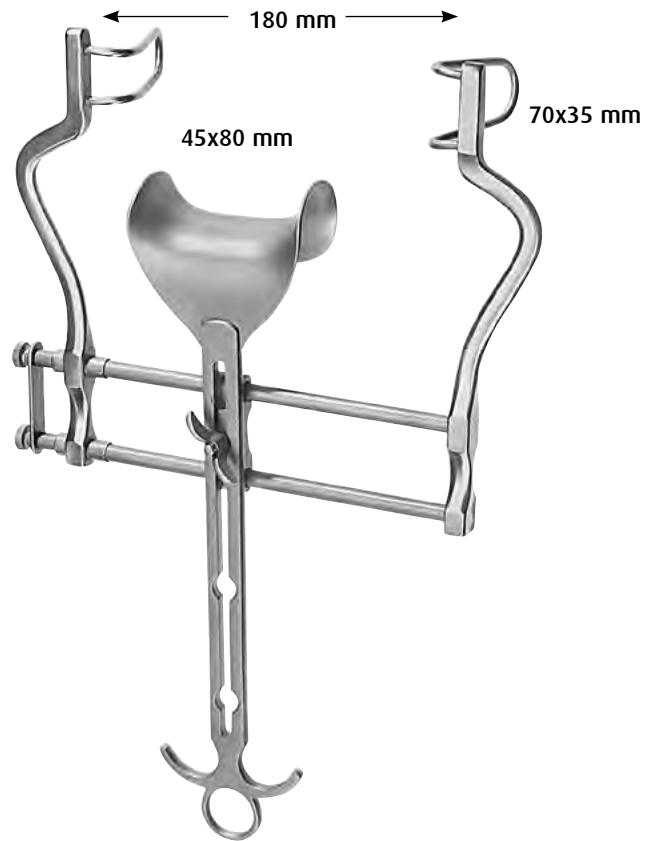

BALFOUR
1162-7718

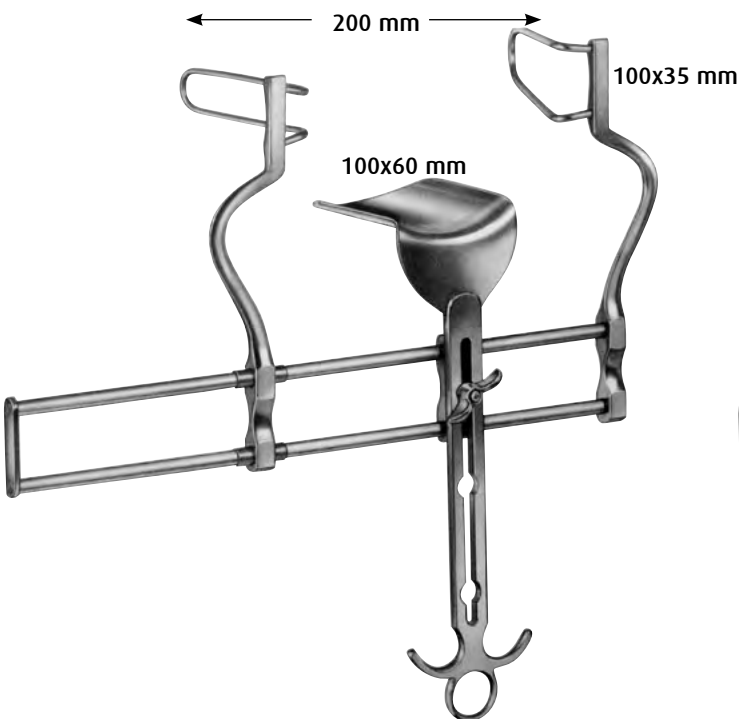

BALFOUR
1162-7720

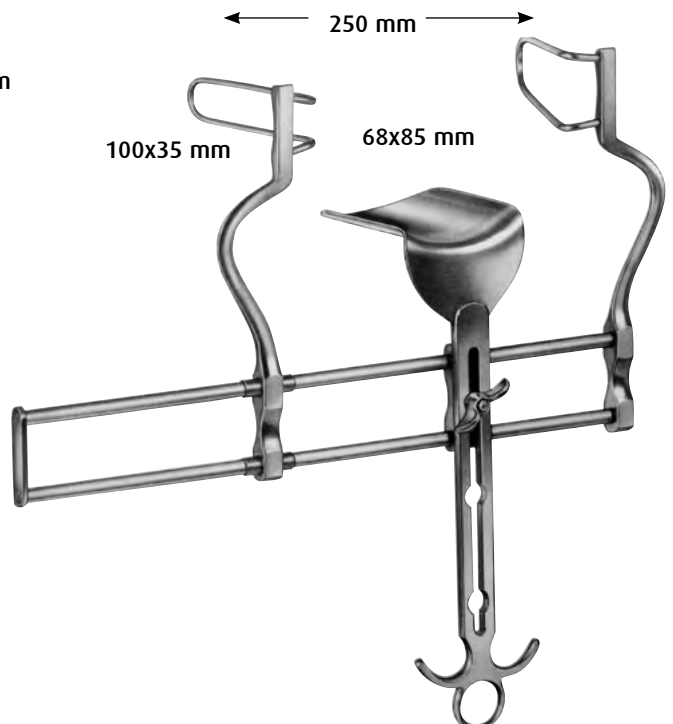

BALFOUR
1162-7725

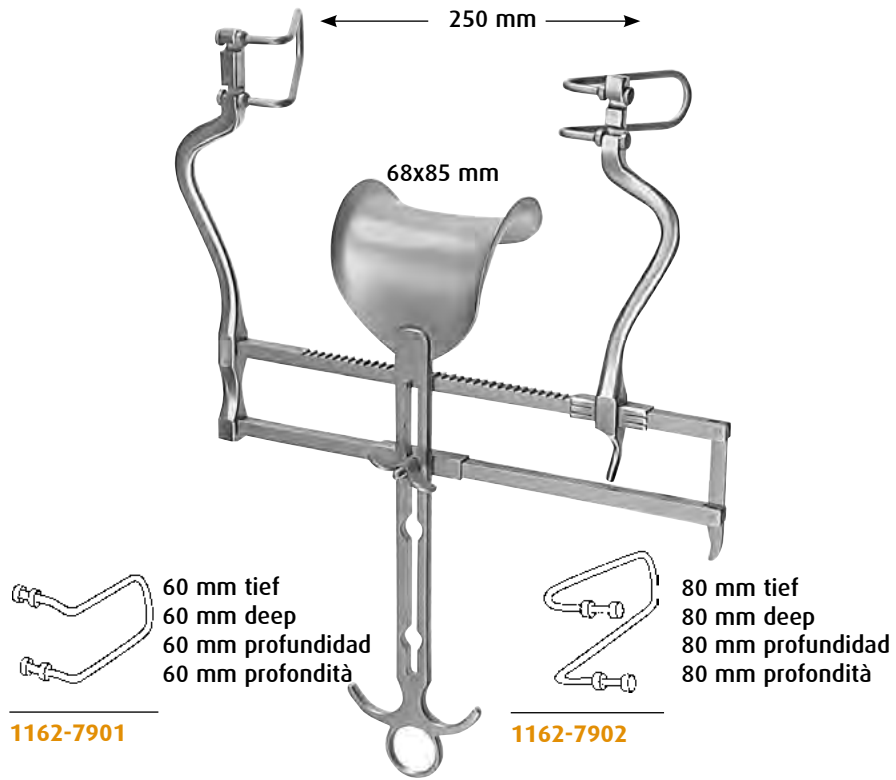

BALFOUR US-TYPE
1162-7900

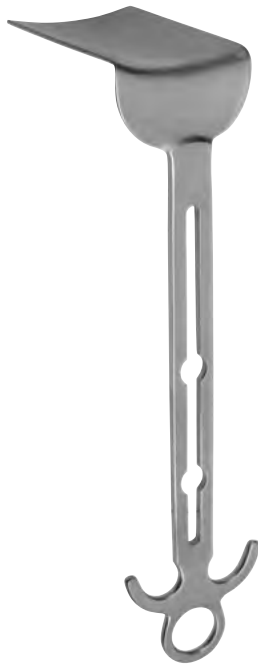

BALFOUR
1162-8000 100x60 mm

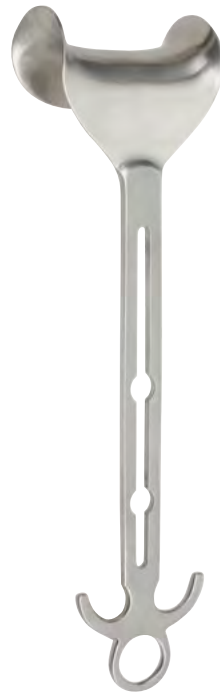

BALFOUR
1162-8001 45x80 mm
1162-8002 68x85 mm

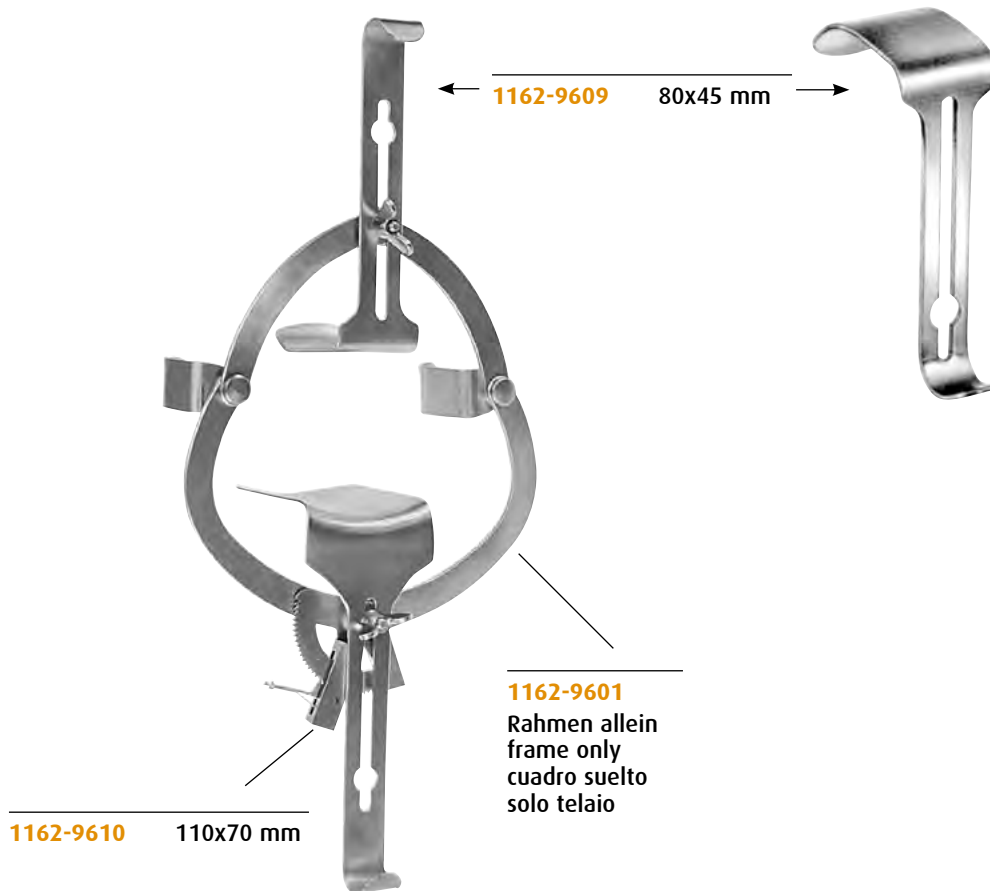

O'SULLIVAN-O'CONNOR

1162-9600

komplett, complete, completo, completo

1 x 1162-9601

2 x 1162-9609

1 x 1162-9610

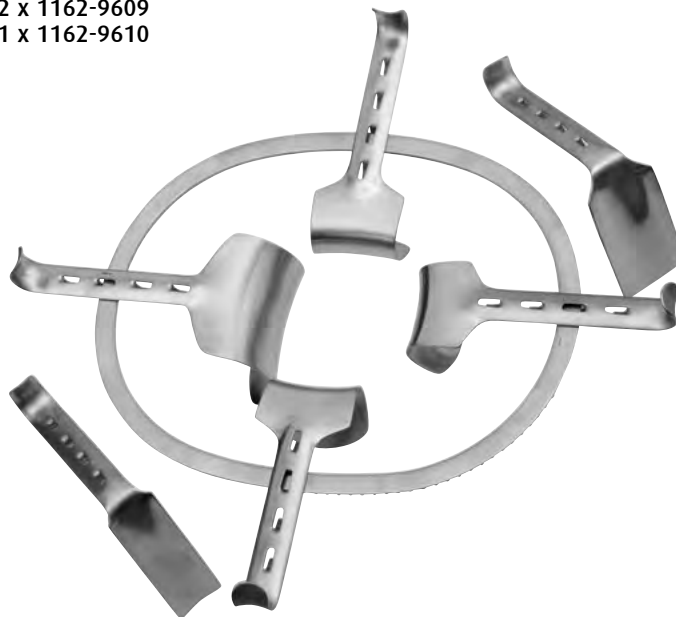

KIRSCHNER

1162-8400

komplett, complete, completo, completo

1 x 1350-9501

3 x 1162-8350

1 x 1162-8380

1 x 1162-8398

1 x 1162-8399

1162-8430 300 x 240 mm

Rahmen allein

frame only

cuadro suelto

telaio solo

Bauchdeckenhalter
Abdominal Retractors
Separadores abdominales
Divaricatori addominali

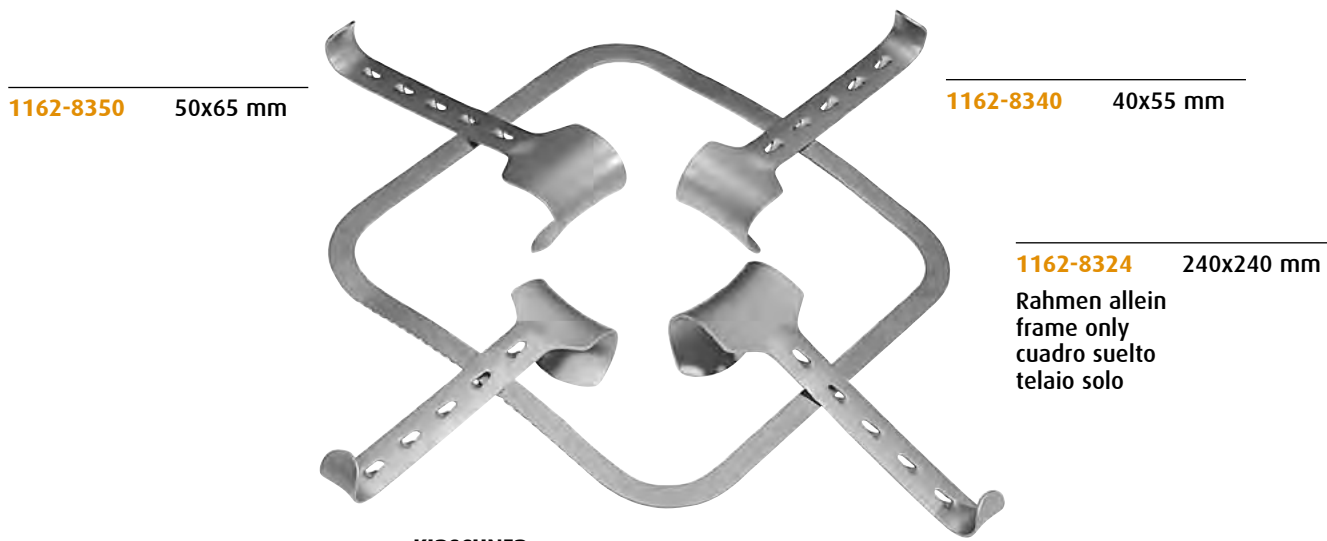

1162-8350 50x65 mm

1162-8340 40x55 mm

1162-8324 240x240 mm
 Rahmen allein
 frame only
 cuadro suelto
 telaio solo

KIRSCHNER
1162-8300
 komplett, complete, completo, completo
 1 x 1162-8324
 2 x 1162-8340
 2 x 1162-8350



KIRSCHNER
1162-8380 80x90 mm
1162-8390 90x65 mm

KIRSCHNER
1162-8360 60x85 mm

KIRSCHNER-BALFOUR
1162-8375 80x80 mm



KIRSCHNER
1162-8398 98x50 mm
1162-8399 105x35 mm

KIRSCHNER
1162-8500 270x270 mm
 komplett, complete, completo, completo
 1 x 1162-8332
 2 x 1162-8340
 2 x 1162-8350

1162-8332 270x270 mm
 zusammenlegbarer Rahmen, allein
 folding frame, only
 cuadro plegable, suelto
 telaio pieghevole, solo

1162-9001 45x57 mm



1162-9003 83x94 mm

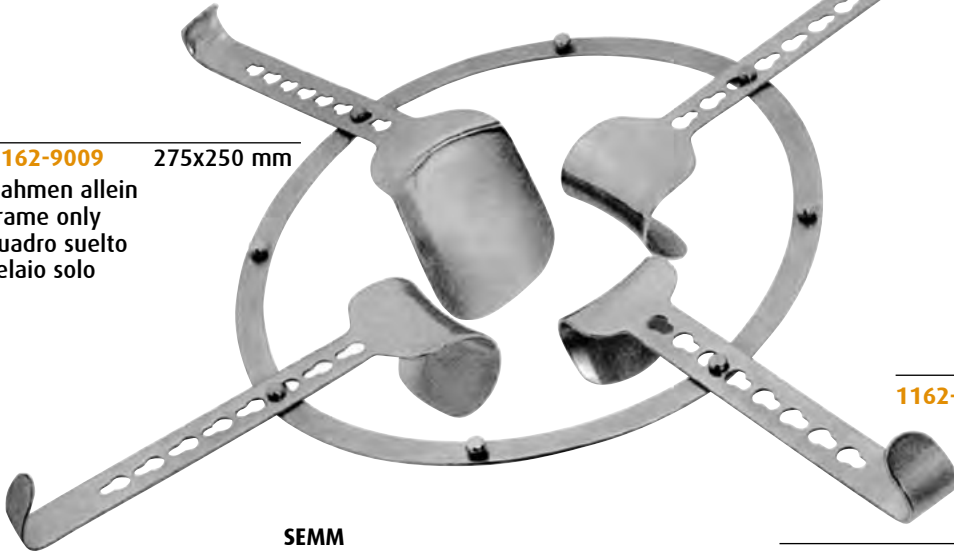

1162-9009 275x250 mm

Rahmen allein
 frame only
 cuadro suelto
 telaio solo

1162-9004 98x50 mm

1162-9005 105x35 mm

SEMM

1162-9000

komplett, complete, completo, completo

1 x 1162-9009

1 x 1162-9004

1 x 1162-9005

1 x 1162-9003

2 x 1162-9001

1 x 1162-9002

1162-9002 50x54 mm

1162-8140 40x40 mm

1162-8136 40x30 mm

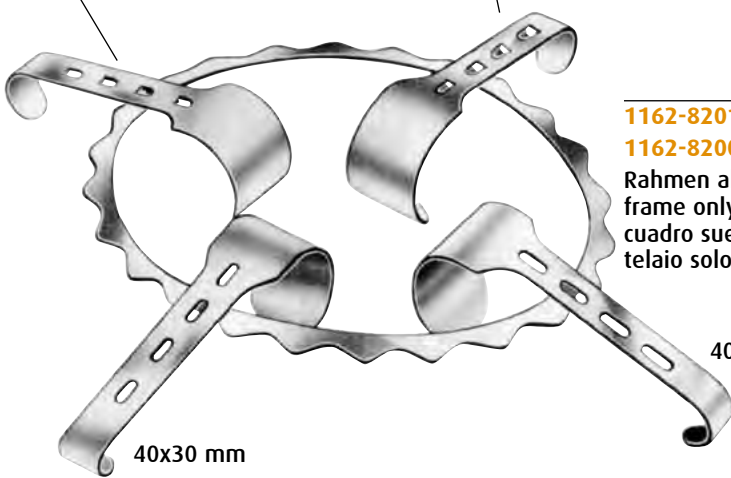

1162-8201 255x180 mm

1162-8200 150x180 mm

Rahmen allein
 frame only
 cuadro suelto
 telaio solo

40x40 mm



1162-8130 20x30 mm

1162-8132 20x40 mm

DENIS-BROWNE

1162-8100

1 x 1162-8200

2 x 1162-8136

2 x 1162-8140

DENIS-BROWNE

1162-8101

1 x 1162-8201

2 x 1162-8136

2 x 1162-8140

Bauchdeckenhalter
Abdominal Retractors
Separadores abdominales
Divaricatori addominali

016

1162-8610 40x60 mm



1162-8612 48x56 mm

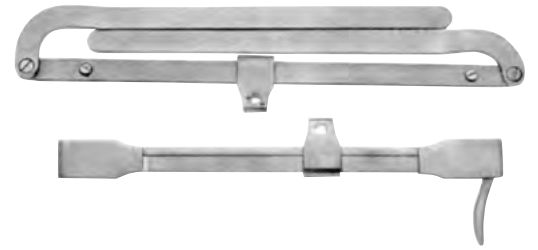

1162-8601 220x220 mm
 zusammenlegbarer Rahmen, allein
 folding frame, only
 cuadro plegable, suelto
 telaio piegabile, solo

FRANZ

1162-8600

komplett, complete, completo, completo

- 1 x 1162-8601
- 2 x 1162-8612
- 2 x 1162-8610

FRANZ

1162-8705

komplett, complete, completo, completo

- 1 x 1162-8601
- 2 x 1162-8612
- 2 x 1162-8611
- 2 x 1162-8610
- 2 x 1162-8605



1162-8610 40x60 mm
1162-8605 40x80 mm

1162-8612 48x56 mm
1162-8611 50x85 mm



Kette mit Gewicht
 Chain with weight
 Cadena con peso
 Catena con peso

DOYEN

- 1163-3001** 28,0 cm /11" 90x50 mm
- 1163-3002** 28,0 cm /11" 105x50 mm
- 1163-3003** 28,0 cm /11" 120x50 mm
- 1163-3004** 28,0 cm /11" 135x50 mm

1163-3100 79,0 cm /31"



ROCHARD
1163-0001



ROCHARD
1163-0002



ROCHARD
1163-0005 19,0 cm /11"

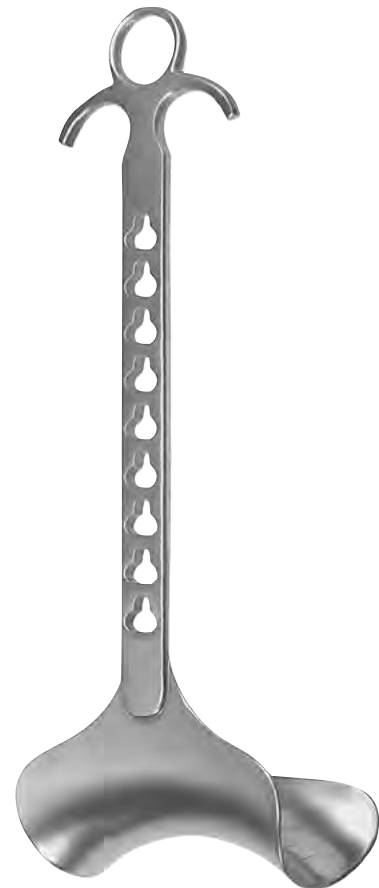

ROCHARD

1163-0009	28,0 cm /11"	95x50 mm
1163-0010	28,0 cm /11"	105x50 mm
1163-0012	28,0 cm /11"	120x60 mm
1163-0013	28,0 cm /11"	135x60 mm
1163-0015	28,0 cm /11"	155x60 mm

017

**Sonden, Aspiration
Probes, Aspiration
Sondas, Aspiración
Sonde, Aspirazione**





ø 1,0 mm	ø 1,5 mm	ø 2,0 mm	
1106-0011	1106-0111	1106-0211	11,5 cm / 4 ¹ / ₂ "
1106-0013	1106-0113	1106-0213	13,0 cm / 5"
1106-0014	1106-0114	1106-0214	14,5 cm / 5 ³ / ₄ "
1106-0016	1106-0116	1106-0216	16,0 cm / 6 ¹ / ₄ "
1106-0018	1106-0118	1106-0218	18,0 cm / 7"
1106-0020	1106-0120	1106-0220	20,0 cm / 8"
	1106-0125	1106-0225	25,0 cm / 9 ³ / ₄ "
		1106-0230	30,0 cm / 11 ³ / ₄ "

ø 2,0 mm	
1106-0411	11,5 cm / 4 ¹ / ₂ "
1106-0413	13,0 cm / 5"
1106-0414	14,5 cm / 5 ³ / ₄ "
1106-0416	16,0 cm / 6 ¹ / ₄ "
1106-0418	18,0 cm / 7"
1106-0420	20,0 cm / 8"
1106-0425	25,0 cm / 9 ³ / ₄ "

Ø 1,0 mm



Silber
Silver
Plata
argento



STACKE	
1106-0810	10,5 cm / 4 ¹ / ₈ "

ø 1,5 mm	ø 2,0 mm	
-	1106-0613	13,0 cm / 5"
1106-0514	1106-0614	14,5 cm / 5 ³ / ₄ "
-	1106-0616	16,0 cm / 6 ¹ / ₄ "
-	1106-0618	18,0 cm / 7"
-	1106-0620	20,0 cm / 8"

ø 3,5 mm	
1106-1011	11,5 cm / 4 ¹ / ₂ "
1106-1013	13,0 cm / 5"
1106-1014	14,5 cm / 5 ³ / ₄ "
1106-1016	16,0 cm / 6 ¹ / ₄ "
1106-1018	18,0 cm / 7"
1106-1020	20,0 cm / 8"



ø 3,3 mm

- 1106-1213 13,0 cm / 5"
- 1106-1214 14,5 cm / 5³/₄"
- 1106-1216 16,0 cm / 6¹/₄"
- 1106-1218 18,0 cm / 7"
- 1106-1220 20,0 cm / 8"



DOYEN

- 1106-1314 14,5 cm / 5³/₄"



NELATON

- 1106-1516 16,0 cm / 6¹/₄"



BRODIE

- 1106-1620 20,0 cm / 8"



LOCKHARD-MUMMERY

- 1106-1816 16,5 cm / 6¹/₂"

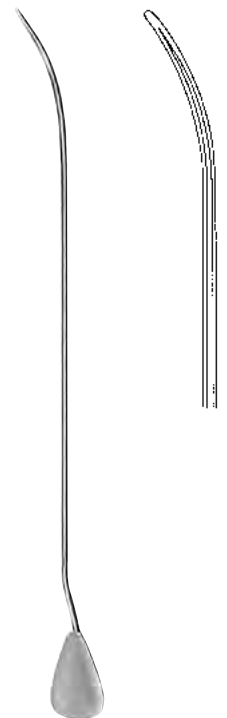

LOCKHARD-MUMMERY

- 1106-1916 16,5 cm / 6¹/₂"

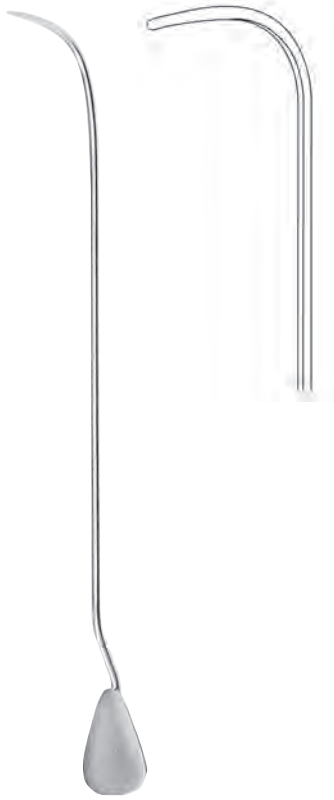

LOCKHARD-MUMMERY

1106-2116 16,5 cm / 6 1/2"

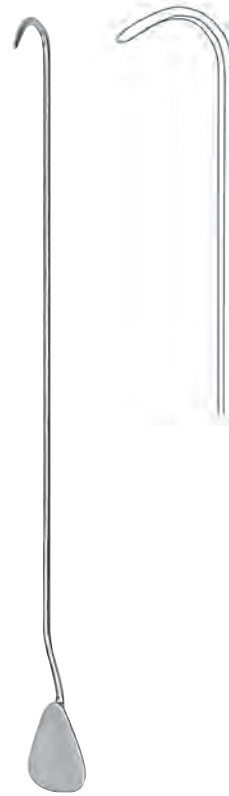

LOCKHARD-MUMMERY

1106-2316 16,5 cm / 6 1/2"

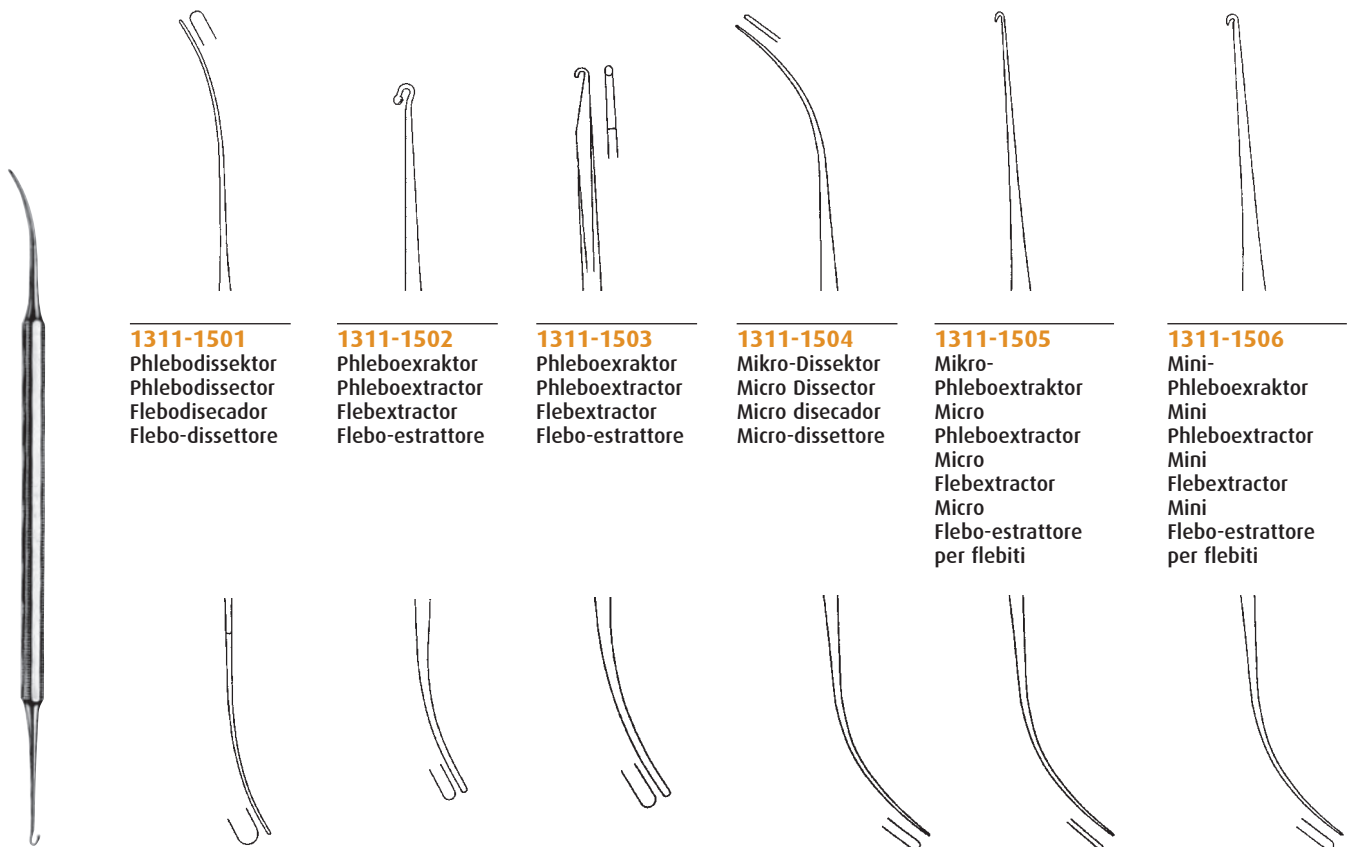

1311-1501
Phleboexraktor
Phleboextractor
Flebodisecador
Flebo-dissetto

1311-1502
Phleboexraktor
Phleboextractor
Flebextractor
Flebo-estrattore

1311-1503
Phleboexraktor
Phleboextractor
Flebextractor
Flebo-estrattore

1311-1504
Mikro-Dissektor
Micro Dissector
Micro disecador
Micro-dissetto

1311-1505
Mikro-
Phleboexraktor
Micro
Phleboextractor
Micro
Flebextractor
Micro
Flebo-estrattore
per flebiti

1311-1506
Mini-
Phleboexraktor
Mini
Phleboextractor
Mini
Flebextractor
Mini
Flebo-estrattore
per flebiti

VARADY

1311-1501 - 1311-1506 18,0 cm / 7"

Krampfader-Besteck
Varicose Vein Probe Set
Juego para várices
Astuccio per varici

017



1310-1009 135x100x25 mm

Metalletui
 Metal case
 Estuche de metal
 Scatola in metallo

NABATOFF

1310-1000

komplett
 complete
 completo
 completo



1310-1003
 Ø 3,0 mm



1310-1004
 Ø 6,0 mm

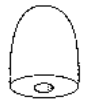

1310-1005
 Ø 9,0 mm

1310-1001

Zugseil
 Cable
 Cable
 Fune

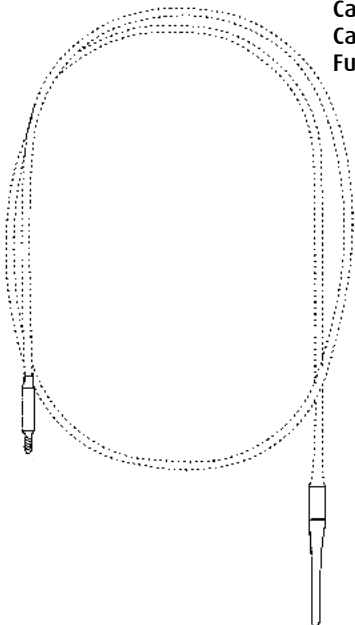

1310-1006
 Ø 12,0 mm



1310-1007
 Ø 15,0 mm

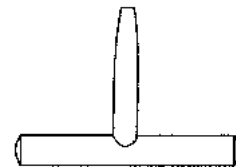

1310-1008
 Handgriff
 Handle
 Mango
 Manico

1310-1002

Kunststoff-Sondenspitze
 Plastic probe tip
 Punta de sonda de plastico
 Punta di sonda di plastica



VOLLMAR

1310-1302 - 1310-1314 50 cm / 19³/₄"

1310-1200 12,0 cm / 4³/₃"

Handgriff für Ringstripper nach Vollmar
 Handle for Vollmar Ring Stripper
 Mango para Vollmar fleboextractor
 Manico per stripper anello di Vollmar

Sonden, Phlebotomier
 Probes, Phlebotomizers
 Sondas, Flebotomizadores
 Sonde, Flebo-dissettori



JOBSON-HORNE
 1106-3618 18,0 cm / 7"

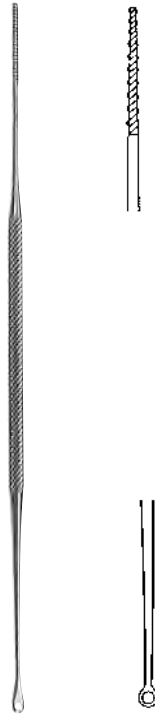

UCKERMANN
 1106-3615 16,0 cm / 6 1/4"



FARRELL
 1106-3112 Ø 0,9 mm 12,0 cm / 4 3/4"
 1106-3114 Ø 0,9 mm 14,0 cm / 5 1/2"
 1106-3116 Ø 1,1 mm 16,5 cm / 6 1/2"
 1106-3118 Ø 1,2 mm 18,0 cm / 7"



FARRELL
 1106-3012 Ø 0,9 mm 12,0 cm / 4 3/4"
 1106-3014 Ø 0,9 mm 14,0 cm / 5 1/2"
 1106-3016 Ø 1,1 mm 16,5 cm / 6 1/2"
 1106-3018 Ø 1,2 mm 18,0 cm / 7"

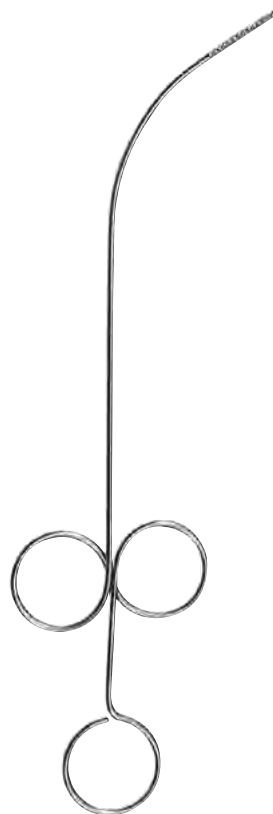

FEIN
 1262-4528 28,0 cm / 11"

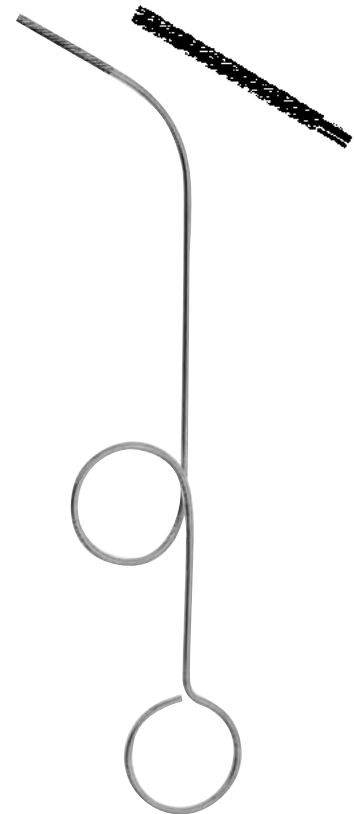

PELTESON
 1262-4523 23,0 cm / 9"

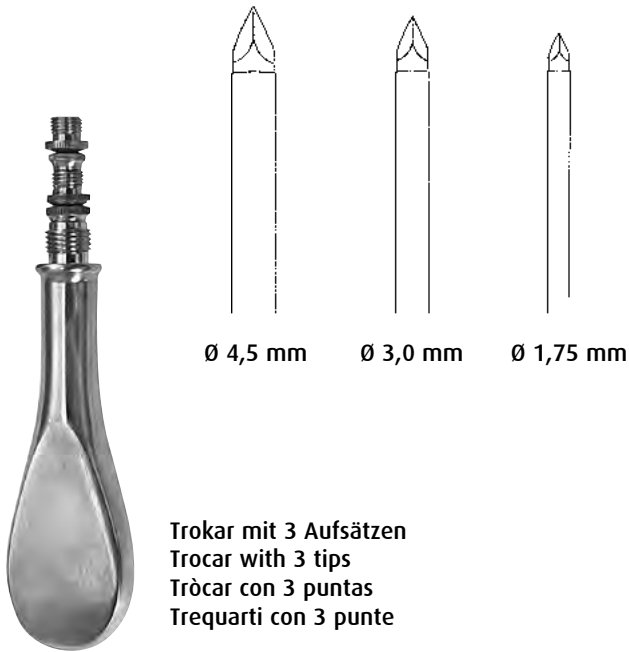

Trokar mit 3 Aufsätzen
Trocar with 3 tips
Trócar con 3 puntas
Trequarti con 3 punte

UNIVERSAL

1107-2003

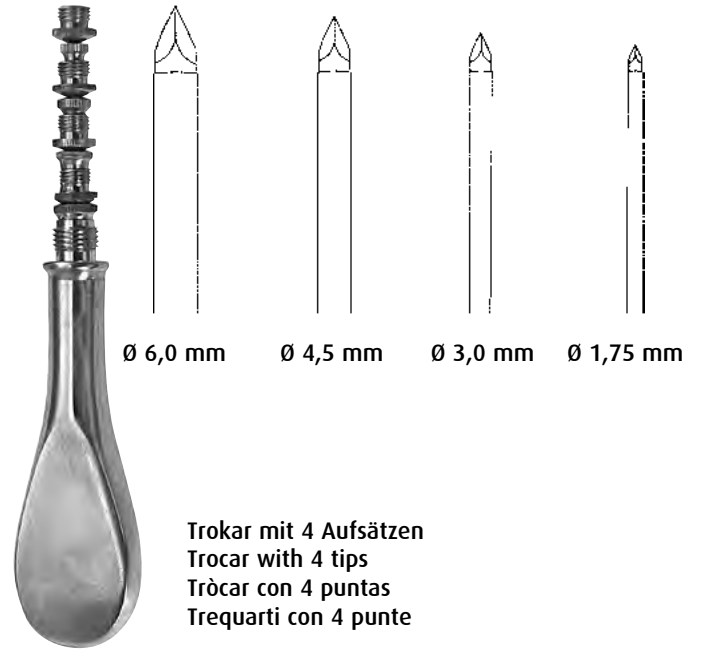

Trokar mit 4 Aufsätzen
Trocar with 4 tips
Trócar con 4 puntas
Trequarti con 4 punte

UNIVERSAL

1107-2004



STANDARD

1107-2401	Ø 3,0 mm
1107-2402	Ø 3,5 mm
1107-2403	Ø 4,0 mm
1107-2404	Ø 4,5 mm
1107-2405	Ø 5,0 mm
1107-2406	Ø 5,5 mm
1107-2407	Ø 6,0 mm

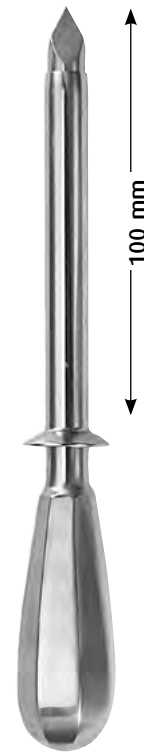

NELSON

1107-2375	Ø 7,5 mm
1107-2390	Ø 9,0 mm
1107-2311	Ø 11,0 mm

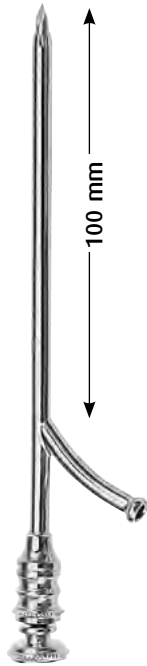

OCHSNER

- 1107-3640 Ø 4,0 mm
- 1107-3653 Ø 5,5 mm
- 1107-3660 Ø 6,5 mm



Kieferhöhlentrokare
Antrum trocars
Trócares para el seno maxilar
Trequarti per puntura del seno
mascellare

LICHTWITZ

- 1107-3018 19,0 cm / 7 1/2"



DOUGLAS

- 1107-3903 Ø 3,0 mm



KRAUSE

- 1107-3304 Ø 4,0 mm
- 1107-3305 Ø 5,5 mm



PIERCE

- 1107-3104 Ø 4,0 mm



BUELAU

- 1107-2808 Ø 8,0 mm



Ø 2,0 mm

LANDAU

1107-3802 16,0 cm / 6 1/4"



Ø 2,3 mm

COAKLEY

1107-4103 14,0 cm / 5 1/4"



Ø 4,0 mm

ADSON

1109-0504 21,0 cm / 8 1/4"



Ø 3,0 mm

ADSON

1109-0503 16,5 cm / 6 1/2"



FRAZIER

1109-0510 Charr. 10 20,0 cm / 8"



FRAZIER

1109-0206	Charr. 6	19,0 cm / 7 1/2"
1109-0207	Charr. 7	19,0 cm / 7 1/2"
1109-0208	Charr. 8	19,0 cm / 7 1/2"
1109-0209	Charr. 9	19,0 cm / 7 1/2"
1109-0210	Charr. 10	19,0 cm / 7 1/2"
1109-0211	Charr. 11	19,0 cm / 7 1/2"
1109-0212	Charr. 12	19,0 cm / 7 1/2"





POPPE

1109-0246	Charr. 6	13,0 cm / 5"
1109-0248	Charr. 8	13,0 cm / 5"
1109-0250	Charr. 10	13,0 cm / 5"
1109-0252	Charr. 12	13,0 cm / 5"



PLESTER

1109-0305	Ø 1,5 mm	19,5 cm / 7 2/3"
1109-0306	Ø 2,0 mm	19,5 cm / 7 2/3"
1109-0307	Ø 2,5 mm	19,5 cm / 7 2/3"
1109-0309	Ø 3,0 mm	19,5 cm / 7 2/3"



LEMPERT

1109-0807	Ø 2,0 mm	20,0 cm / 8"
1109-0809	Ø 3,0 mm	20,0 cm / 8"



COGSWELL

1109-0623 23,0 cm / 9"



Präpariersauger
Suction raspatory
Aspirador para preparacion
Aspiratore per preparazione

LANDOLT

1109-0620 20,0 cm / 8"

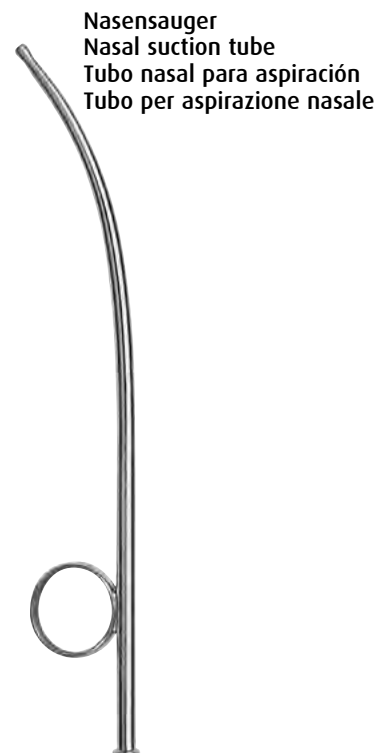

Nasensauger
Nasal suction tube
Tubo nasal para aspiración
Tubo per aspirazione nasale

KILNER

1109-0619 19,0 cm / 7 1/2"

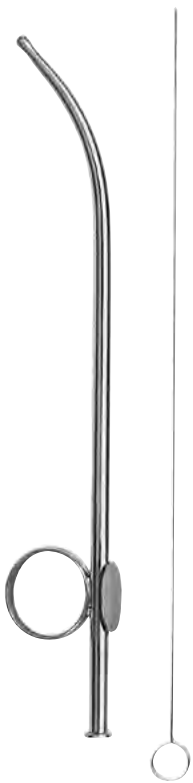

MAGILL

1109-0630	Ø 3,0 mm	24,5 cm / 6,9"
1109-0635	Ø 3,5 mm	24,5 cm / 6,9"
1109-0640	Ø 4,0 mm	24,5 cm / 6,9"



1109-0004

1109-0006

1109-0008

1109-0001
MIKRO-Absaugrohr, allein
MICRO-suction tube, only
MICRO-Tubo de aspiracio, suelto
MICRO-Tubo d'aspirazione, solo

WULLSTEIN

1109-0000 17,0 cm / 6³/₄"

Komplett bestehend aus: 1 MIKRO-Absaugrohr mit LUER-Bohrung (1109-0001) und
3 MIKRO-Saugkanülen Ø 0,4 mm - Ø 0,8 mm (1109-0004, -0006 und -0008)
Complete consisting of: 1 MICRO-Suction tube with LUER hub (1109-0001) and
3 MICRO-Suction cannulas Ø 0,4 mm - Ø 0,8 mm (1109-0004, -0006 und -0008)
Completo compuesto de: 1 MICRO-Tubo de aspiración con cono LUER (1109-0001) y
3 MICRO-cánulas para aspiración Ø 0,4 mm - Ø 0,8 mm (1109-0004, -0006 und -0008)
Completo composto da: 1 MICRO-Tubo d'aspirazione, perforazione LUER (1109-0001) e
3 MICRO-cannule d'aspirazione Ø 0,4 mm - Ø 0,8 mm (1109-0004, -0006 und -0008)

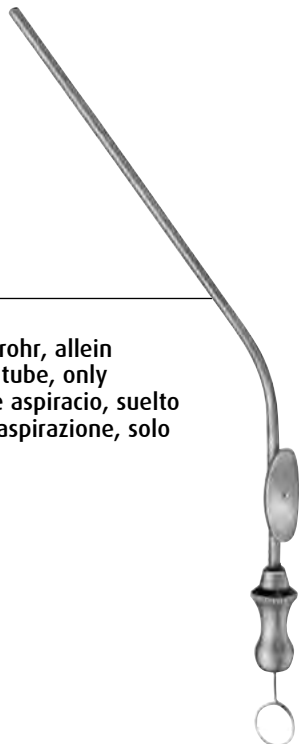

Ø 0,5 mm Ø 0,7 mm Ø 0,9 mm

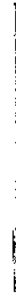

1108-7805

1108-7807

1108-7809

1108-7801
MIKRO-Absaugrohr, allein
MICRO-suction tube, only
MICRO-Tubo de aspiracio, suelto
MICRO-Tubo d'aspirazione, solo

BELLUCCI

1108-7800 15,5 cm / 6"

Komplett bestehend aus: 1 MIKRO-Absaugrohr mit LUER-Bohrung (017-420-001) und
3 MIKRO-Saugkanülen Ø 0,5 mm - Ø 0,9 mm (017-420-005, -007 und -009)
Complete consisting of: 1 MICRO-Suction tube with LUER hub (017-420-001) and
3 MICRO-Suction cannulas Ø 0,5 mm - Ø 0,9 mm (017-420-005, -007 und -009)
Completo compuesto de: 1 MICRO-Tubo de aspiración con cono LUER (017-420-001) y
3 MICRO-cánulas para aspiración Ø 0,5 mm - Ø 0,9 mm (017-410-005, -007 und -009)
Completo composto da: 1 MICRO-Tubo d'aspirazione, perforazione LUER (017-420-001) e
3 MICRO-Cannule d'aspirazione Ø 0,5 mm - Ø 0,9 mm (017-420-005, -007 und -009)



SCHUKNECHT

1109-6320	Ø 0,5 mm	13,0 cm / 5 ¹ / ₈ "
1109-6324	Ø 0,9 mm	13,0 cm / 5 ¹ / ₈ "



BARRON

1109-6303	Ø 1,0 mm	10,0 cm / 4"
1109-6307	Ø 2,3 mm	10,0 cm / 4"

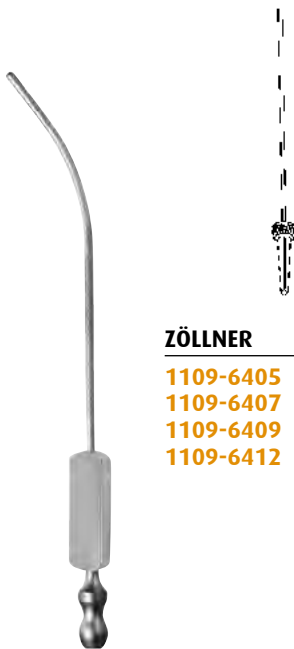

ZÖLLNER

1109-6405	Ø 0,5 mm
1109-6407	Ø 0,7 mm
1109-6409	Ø 0,9 mm
1109-6412	Ø 1,2 mm

ZÖLLNER

1109-6400	18,0 cm / 7"
-----------	--------------



HOUSE

1109-4707	Ø 0,9 mm/0,7 mm
1109-4709	Ø 1,2 mm/0,9 mm
1109-4712	Ø 1,5 mm/1,2 mm

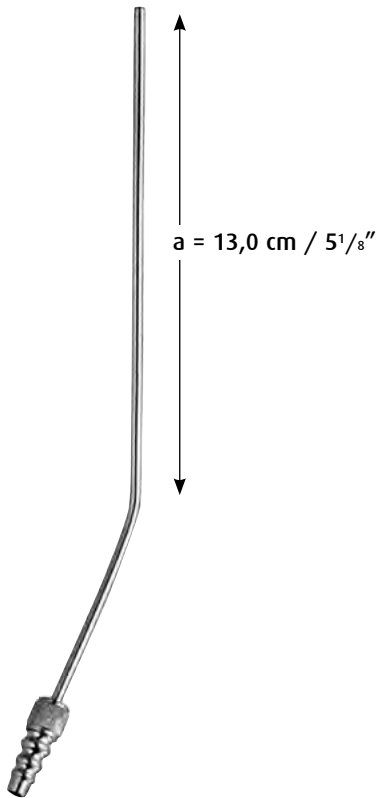

YASARGIL

1109-1015	∅ 1,5 mm
1109-1020	∅ 2,0 mm
1109-1024	∅ 2,5 mm
1109-1033	∅ 3,5 mm

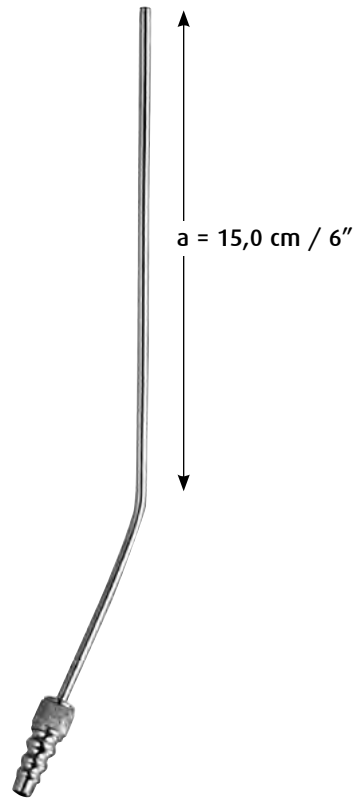

YASARGIL

1109-1016	∅ 1,5 mm
1109-1021	∅ 2,0 mm
1109-1025	∅ 2,5 mm
1109-1035	∅ 3,5 mm

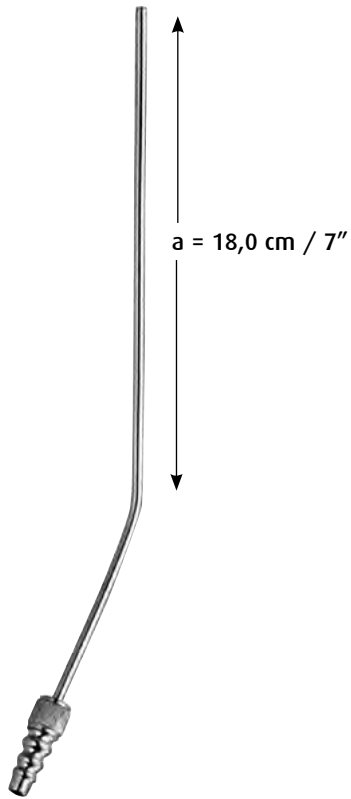

YASARGIL

1109-1017	∅ 1,5 mm
1109-1022	∅ 2,0 mm
1109-1026	∅ 2,5 mm
1109-1036	∅ 3,5 mm

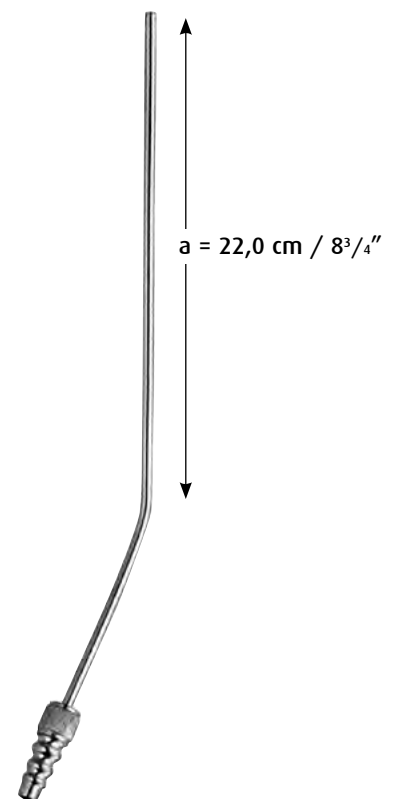

YASARGIL

1109-1018	∅ 1,5 mm
1109-1023	∅ 2,0 mm
1109-1027	∅ 2,5 mm
1109-1037	∅ 3,5 mm



YANKAUER
1109-1102 27,0 cm / 10³/₄"



YANKAUER
1109-1101 28,5 cm / 11¹/₄"



ANDREWS-PYNCHON
1109-1105 24,0 cm / 9¹/₂"



POOLE
1109-1410 22,0 cm / 8⁵/₈"

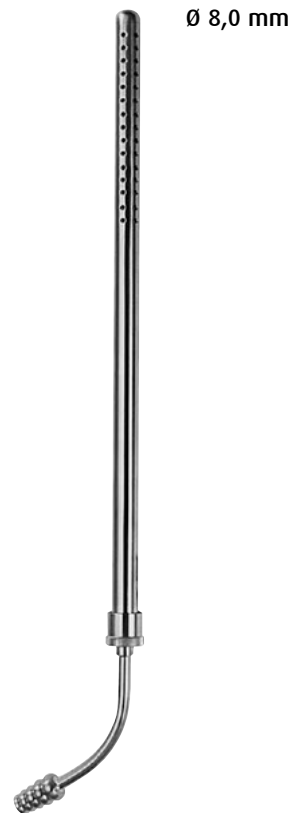

POOLE
1109-1508 22,0 cm / 8⁵/₈"

Saug- und Spülinstrumente
Aspirating and Irrigating Instruments
Instrumentos de aspiración y de lavado
Strumenti per aspirazione e lavaggio

017

Ø 8,0 mm



COOLEY

1109-1708 35,0 cm / 13³/₄"

Ø 7,0 mm



COOLEY

1109-2107 30,0 cm / 11³/₄"

Ø 3,5 mm



1109-1335

Ø 3,5 mm

Ø 10,0 mm



COOLEY

1109-1910 31,0 cm / 11³/₄"

Ø 8,0 mm



COOLEY

1109-2308 33,0 cm / 13"



COUPLAND

1109-1301

17,0 cm / 6³/₄"

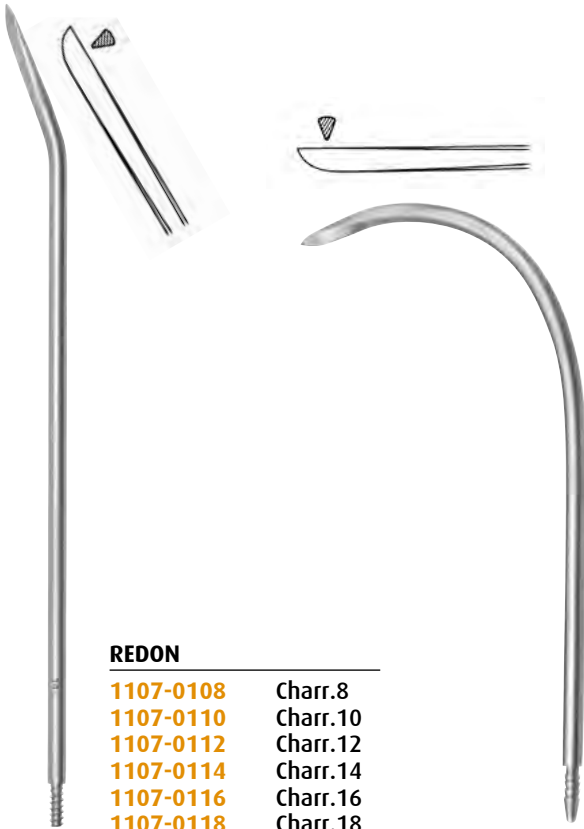

REDON

1107-0108	Charr.8
1107-0110	Charr.10
1107-0112	Charr.12
1107-0114	Charr.14
1107-0116	Charr.16
1107-0118	Charr.18

REDON

1107-0408	Charr.8
1107-0410	Charr.10
1107-0412	Charr.12
1107-0414	Charr.14
1107-0416	Charr.16
1107-0418	Charr.18



REDON

1107-0908	Charr.8
1107-0910	Charr.10
1107-0912	Charr.12
1107-0914	Charr.14
1107-0916	Charr.16
1107-0918	Charr.18



REDON

1107-0608	Charr.8
1107-0610	Charr.10
1107-0612	Charr.12
1107-0614	Charr.14
1107-0616	Charr.16
1107-0618	Charr.18

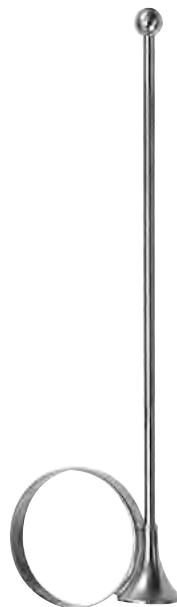

IOWA

1108-0200	14,0 cm / 5 1/4"
-----------	------------------



1108-0201



1108-0412 Ø 1,20x80 mm
1108-0415 Ø 1,50x80 mm



Kanülen zur Leberblindpunktion
 Liver blind puncture needles
 Agujas para punción ciega del hígado
 Aghi per la punture cieca del fegato

MENGHINI

1108-2210 Ø 1,00x 35 mm
1108-2215 Ø 1,00x 70 mm
1108-2220 Ø 1,20x 70 mm
1108-2225 Ø 1,20x 100 mm
1108-2230 Ø 1,40x 70 mm
1108-2235 Ø 1,40x 100 mm
1108-2240 Ø 1,60x 70 mm
1108-2250 Ø 1,60x 100 mm



QUINKE

1108-2805 Ø 1,20x 76 mm
1108-2807 Ø 1,20x 89 mm
1108-2803 Ø 1,00x 76 mm
1108-2804 Ø 1,00x 89 mm
1108-2801 Ø 0,70x 76 mm
1108-2812 Ø 0,70x 89 mm



Kanülen zur Lumbalpunktion
 Lumbar puncture needles
 Agujas para punción lumbar
 Aghi per punture lombari

MENGHINI

1108-2414 Ø 1,40x168 mm
1108-2818 Ø 1,80x168 mm



Kanülen zur Lumbalpunktion
 Lumbar puncture needles
 Aguja para punción lumbar
 Aghi per punture lombari

TUOHY

1108-2376	Ø 1,20x76 mm
1108-2314	Ø 1,40x76 mm
1108-2316	Ø 1,60x76 mm



BIER

1108-2514	Ø 1,4x80 mm
1108-2516	Ø 1,6x80 mm
1108-2518	Ø 1,8x80 mm
1108-2520	Ø 2,0x80 mm
1108-2614	Ø 1,4x100 mm
1108-2616	Ø 1,6x100 mm
1108-2618	Ø 1,8x100 mm
1108-2620	Ø 2,0x100 mm



VERRES

1108-1210	Ø 2,00x100 mm
1108-1212	Ø 2,00x120 mm
1108-1215	Ø 2,00x150 mm

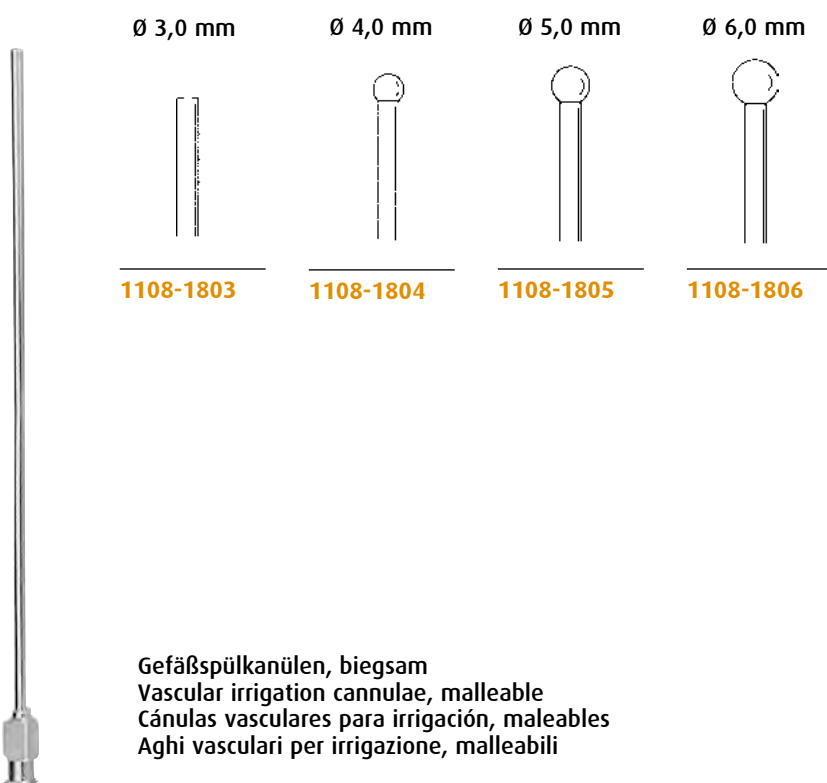

Ø 3,0 mm

Ø 4,0 mm

Ø 5,0 mm

Ø 6,0 mm

1108-1803

1108-1804

1108-1805

1108-1806

Gefäßspülkanülen, biegsam
 Vascular irrigation cannulae, malleable
 Cánulas vasculares para irrigación, maleables
 Aghi vascolari per irrigazione, malleabili

SCHMID

1108-1803 - 1108-1806

15,0 cm / 6"



Kanülen zur Sternalpunktion
Sternum puncture needles
Agujas para la punción del esternón
Aghi per puntura dello sterno

KLIMA-ROSSEGER

1108-1518 Ø 1,60x40 mm

Zwischenstück, LUER-LOCK weiblich, record männlich
 Connecting piece, LUER-LOCK female, record male
 Pieza de conexión, LUER-LOCK hembra, record masculino
 Raccordo, LUER-LOCK femmina, record maschio



1108-1601

Zwischenstück, LUER-LOCK männlich
 Connecting piece, LUER-LOCK male
 Pieza de conexión, LUER-LOCK masculino
 Raccordo, LUER-LOCK maschio



1108-1602

Zwischenstück, LUER-LOCK männlich
 Connecting piece, LUER-LOCK male
 Pieza de conexión, LUER-LOCK masculino
 Raccordo, LUER-LOCK maschio



1108-9006 Ø 6 mm
 1108-9008 Ø 8 mm

Zwischenstück, LUER-LOCK weiblich
 Connecting piece, LUER-LOCK female
 Pieza de conexión, LUER-LOCK hembra
 Raccordo, LUER-LOCK femmina



1108-9406

Durchflußhahn, LL männl. - LL weibl.
 Stopcock, LL male - LL female
 Llave, LL masculino - LL hembra
 Rubinetto, LL maschio - LL femmina



1109-8000

Durchflußhahn, LL weibl.
 Stopcock, LL female
 Llave, LL hembra
 Rubinetto, LL femmina



1109-8100

Dreiweghahn, 1 LL männl. - 2 LL weibl.
 Three-way-stopcock, 1 LL male - 2 LL female
 Llave de 3 vías, 1 LL masculino - 2 LL hembra
 Rubinetto a tre vie, 1 LL maschio - 2 LL femmina



1108-8005

Spritzen, Ersatzzylinder
Syringes, Spare barrel
Jeringas, Cilindro de repuesto
Siringhe, Cilindro di ricambio



LUER

1108-4001	1 ml
1108-4002	2 ml
1108-4005	5 ml
1108-4010	10 ml
1108-4020	20 ml
1108-4050	50 ml



LUER-LOCK

1108-4401	1 ml
1108-4402	2 ml
1108-4405	5 ml
1108-4410	10 ml
1108-4420	20 ml
1108-4450	50 ml



LUER-LOCK

1108-4802	2 ml
1108-4805	5 ml
1108-4810	10 ml



1108-4101	1 ml
1108-4102	2 ml
1108-4105	5 ml
1108-4110	10 ml
1108-4120	20 ml
1108-4150	50 ml



1108-4501	1 ml
1108-4502	2 ml
1108-4505	5 ml
1108-4510	10 ml
1108-4520	20 ml
1108-4550	50 ml



1108-4902	2 ml
1108-4905	5 ml
1108-4910	10 ml



TUBERKULIN LUER LOCK
1108-5501 1 ml



JANET
1108-6005 50 ml
1108-6010 100 ml
1108-6015 150 ml
1108-6020 200 ml



LUER-LOCK
1108-4701 10 ml
1108-4702 20 ml
1108-4703 30 ml
1108-4704 50 ml



1108-4711 1 ml



1108-6205 50 ml
1108-6210 100 ml
1108-6215 150 ml
1108-6220 200 ml



1108-6110 10 ml
1108-6120 20 ml
1108-6130 30 ml
1108-6150 50 ml

018

Diagnostik, Narkose
Diagnostics, Anaesthesia
Diagnóstico, Anestesia
Diagnóstica, Anestesia





TROEMMER

1100-0524 24,0 cm / 9¹/₂"



DEJERINE

1100-0120 20,0 cm / 8"



DEJERINE

1100-0221 21,0 cm / 8¹/₄"



mit Nadel
with needle
con aguja
con ago



TAYLOR

1100-0317 18,0 cm / 7"
1100-0320 20,0 cm / 8"



BERLINER

1100-0417 17,0 cm / 6³/₄"
1100-0420 20,0 cm / 8"



BABINSKI

1101-0722 22,0 cm / 8³/₄"



BABINSKI

1100-0722 22,0 cm / 8³/₄"

mit Nadel
 with needle
 con aguja
 con ago



RABINER

1100-0623 23,0 cm / 9"

mit Nadel und Pinsel
 with needle and pencil
 con aguja y pincel
 con ago e pennello



BUCK

1100-0018 18,0 cm / 7"

mit Nadel und Pinsel
 with needle and pencil
 con aguja y pincel
 con ago e pennello



BUCK

1101-0018 18,0 cm / 7"

Teleskopgriff
 telescope handle
 mango telescópico
 manico telescopico

mit Nadel und Pinsel
 with needle and pencil
 con aguja y pincel
 con ago e pennello



Algesimeter
 Pinwheel
 Rueda de espigas
 Algesimetro

WARTENBERG

1100-1518 19,0 cm / 7 1/2"



Holz
 Wooden
 Madera
 Legno

PINARD

1100-1001 18,0 cm / 7"



Aluminium
 Aluminium
 Aluminio
 Alluminio

PINARD

1100-1002 15,0 cm / 6"

ALUMINIUM



DUPLEX
1100-1201



Ø 47 mm



BABY-DUPLEX
1100-1202



Ø 37 mm



ANESTOPHON
1100-1300

Ø 47 mm

**VIGORIMETER****1100-2600****1100-2601**

Ersatz-Gummibälle
Spare Rubber Balls
Peras de goma
Palloni di ricambio

Satz mit 3 Größen
Set with 3 sizes
Juego con 3 tamaños
Set in 3 misure

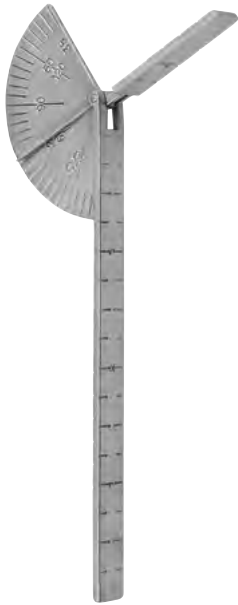

CAROLL
 1100-2102 14,0 cm / 5¹/₂"



MOELTGEN
 1100-2101 23,0 cm / 9"



BERTILLON
 1100-2332 32,0 cm / 12¹/₃"

mit KG-Einteilung für Erwachsene
 with kilogram scale for adults
 con graduacion en kgs para adultos
 con graduazione in kg per adulti



COLLIN
 1100-2401 11,0 cm / 4³/₈"

mit lbs-Einteilung für Erwachsene
 with lbs scale for adults
 con graduacion en lbs para adultos
 con graduazione in lbs per adulti



COLLIN
 1100-2402 11,0 cm / 4³/₈"

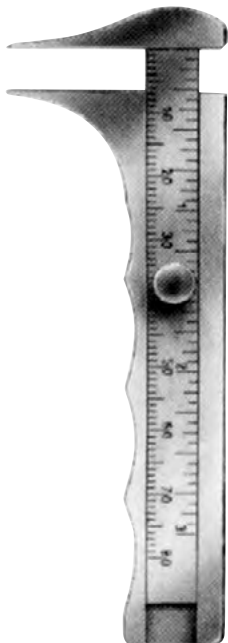

Einteilung in mm und Zoll
graduated in mm and inches
graduado en mm y pulgadas
graduato in mm e pollici

JAMESON

1100-3600

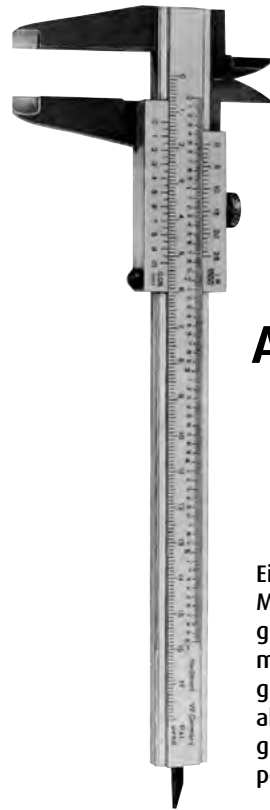

ALUMINIUM

Einteilung in mm und Zoll
Messbereich bis 200 mm
graduated in mm and inches
measuring range up to 200 mm
graduado en mm y pulgadas
alcance de medición hasta 200 mm
graduato in mm e pollici
per misurare fino a 200 mm

1100-3620



-
- 1100-3215** 150 mm
 - 1100-3220** 200 mm
 - 1100-3230** 300 mm
 - 1100-3250** 500 mm

Messstab, graduert in cm und Zoll
Ruler, graduated in cm and inches
Regla, graduado en cm y pulgadas
Misuratori, graduato in cm e pollici



-
- 1100-3350** 500 mm

Röntgen Messstab
Ruler, X-Ray
Regla para rayos X
Misuratore per raggi X



OTOSKOP BESTECK

1100-4818

Otoskopbesteck komplett in Etui bestehend aus:

- 1 Griff Typ C für 2 Batterien oder 1 Accu (ohne Batterien/Accu)
- 1 Otoskopkopf mit Halogenbirne 2,5 V
- je 1 wiederverwendbarer Ohrtrichter ø 2,0 mm, 3,0 mm, 4,0 mm und 5,0 mm, schwarz
- je 3 Einwegohrtrichter ø 2,0 mm und 4,0 mm, blau
- 1 Operationslinse, 4-fach vergrößernd
- 1 Ersatzbirnchen, Halogen 2,5 V

- Otoskopkopf aus robustem Kunststoff
- Fiberoptik für optimale Bündelung und Leitung des Lichts
- Nach beiden Seiten schwenkbare Glasoptik mit 3-fach Vergrößerung
- Operationslinse mit 4-fach Vergrößerung und Miniaturoptik aus Glas für erleichterte Instrumentenführung
- Mit einfach zu bedienender Spekula-Abwurfvorrichtung
- Mit Trichteraufnahme für Spekula und vergrößerter Durchgangsöffnung für Instrumente
- Geeignet zur Durchführung pneumatischer Tests (Lieferung ohne Ball)

Juego para Otoscopia completo en estuche compuesto de:

- 1 mango de pilas tipo C (sin pilas)
- 1 cabeza de otoscopio con bombilla de halógeno 2,5 V
- 1 de c. u. espéculos auriculares reutilizables ø 2,0 mm, 3,0 mm, 4,0 mm y 5,0 mm, negros
- 3 de c. u. espéculos auriculares desechables ø 2,0 mm y 4,0 mm, azules
- 1 lente para operaciones, aumento 4 x
- 1 bombilla de repuesto, halógena 2,5 V

- Cabeza de otoscopio de plástico robusto
- Fibra óptica para una focalización y conducción óptima de la luz
- Óptica de vidrio de 3 aumentos, orientable hacia ambos lados
- Lupa quirúrgica de 4 aumentos, con óptica miniaturizada para facilitar la inserción de los instrumentos
- Con expulsión de espéculos de uso fácil
- Con acogimiento para espéculos y mayor abertura de acceso para instrumentos
- Adecuado para realizar pruebas neumáticas (se suministra sin la pera)

Otoscope Set complete in case consisting of:

- 1 battery handle type C (without batteries)
- 1 otoscope head with halogen bulb 2,5 V
- 1 each reusable ear specula ø 2,0 mm, 3,0 mm, 4, mm and 5,0 mm black
- 3 each disposable ear specula ø 2,0 mm and 4,0 mm, blue
- 1 magnifying lens for operations 4 x
- 1 spare bulb, halogen, 2,5 V

- Otoscope head made of robust plastic material
- Fiberoptics for optimal beaming and transmission of the light
- Bi-directional swivelling optical glass with 3-fold magnification
- Operation lens with 4-fold magnification and glass mini optic ease the insertion of instruments
- Easy-to-operate specula ejection device
- Fitting for specula and enlarged conduit for instruments
- Suitable for pneumatic tests (supplied without ball)

Set per Otoscopia completo in astuccio composto de:

- 1 manico per pila tipo C (senza pila)
- 1 testa di otoscopio con lampadina alogena 2,5 V
- 1 ognuno specolo auricolare riutilizzabile ø 2,0 mm, 3,0 mm, 4,0 mm e 5,0 mm, nero
- 3 ognuno specoli auricolari monouso ø 2,0 mm e 4,0 mm azzurro
- 1 lente per operazione ingrandimento 4 x
- 1 lampadina di ricambio, alogena 2,5V

- Testa di otoscopio di materia plastica robusta
- Fibra ottica per raggiante e conduzione ottimale della luce
- Ottica di vetro da 3 ingrandimento, in due lati orientabile
- Lente per operazione da 4 ingrandimento, con ottica di vetro minimizza per facilitare la introduzione delle strumenti
- Con espulsione degli specoli da uso facile
- Con accoglienza per specoli è ingrandiva apertura del accesso per strumenti
- Appropriato per realizzare test pneumatico (consegna senza pallone)



OPHTHALMOSKOP-BESTECK

1100-4800

Ophthalmoskopbesteck komplett in Etui bestehend aus:

- 1 Griff Typ C für 2 Batterien oder 1 Accu (ohne Batterien/Accu)
- 1 Ophthalmoskop mit Halogenbirne 2,5 V
- 1 Lupe, 5-fach vergrößernd
- 1 Ersatzbirnchen, Halogen, 2,5 V

- Ophthalmoskopkopf aus robustem Kunststoff
- Dioptrienscheibe mit 29 Korrekturlinsen
Plus 1-10, 12, 15, 20, 40
Minus 1-10, 15, 20, 25, 30, 35
- Mit leicht bedienbarem Blendenstellrad mit Halbmond, kleiner/mittlerer/großer Kreisblende, Fixierstern und Schlitz
- Inklusive zu allen Blenden zuschaltbares Filterrad mit Symbolanzeige, Rotfreifilter, Blaufilter und Polarisationsfilter
- Optimierte Hochleistungsoptik mit asphärischer Kondensatorlinse
- Paralleler Strahlengang
- Staubgeschützt

Juego para oftalmología completo en estuche compuesto de:

- 1 mango de pilas tipo C (sin pilas)
- 1 oftalmoscopio con bombilla de halógeno 2,5 V
- 1 lupa, aumento 5x
- 1 bombilla de repuesto, halógeno 2,5 V

- cabeza de oftalmoscopio de plástico robusto
- Ruedecilla de lentes con 29 lentes correctoras
D+ 1-10, 12, 15, 20, 40
D- 1-10, 15, 20, 25, 30, 35
- Con ruedecilla de diafragmación de fácil uso, diafragma circular pequeño/mediano/grande, estrella de fijación y rendija
- Incluye una rueda de filtros aplicable a todos los diafragmas con indicador de símbolos, filtro azul, de polarización y exento de rojo
- Óptica de alto rendimiento con lente condensadora esférica
- Trayectoria paralela del haz
- Protección contra el polvo

Ophthalmoscope Set complete in case consisting of:

- 1 battery handleType C (without batteries)
- 1 ophthalmoscope with halogen bulb 2,5 V
- 1 magnifying lens, 5x
- 1 spare bulb, halogen 2,5 V

- ophthalmoscope head made of robust plastic material
- Diopter wheel with 29 corrective lenses
Plus 1-10, 12, 15, 20, 40
Minus 1-10, 15, 20, 25, 30, 35
- Easy-to-operate aperture hand-wheel with semi-circle, small/medium/large circle, fixation star and slit
- Includes filter wheel engageable for all apertures with symbol display, red-free filter, blue filter and polarization filter
- Optimized high-performance optics with aspherical condenser lens
- Parallel beam path
- Dust-proof

Set per oftalmologia completo in astuccio composto da:

- 1 manico per pila tipo C (senza pila)
- 1 oftalmoscopio con lampadina alogena 2,5 V
- 1 lente, ingrandimento 5x
- 1 lampadina di ricambio, alogena 2,5 V

- testa di oftalmoscopio di materia plastica robusta
- Carrucola da lente con 29 lenti correttive
D+ 1-10, 12, 15, 20, 40
D- 1-10, 15, 20, 25, 30, 35
- Con carrucola da diaframma e semicerchio da uso facile, diaframma circolare piccolo/medio/largo stella per fissare e fessura
- Include carrucola da filtri appropriato a tutti diaframma con indicatore da simboli, filtri azzurro, di polarizzazione e libero da rosso
- Ottica di alto rendimento con lente condensadora asferica
- Percorso di raggio parallelo
- Protezione contra il polvere



KOMBINATIONS-BESTECK

1100-4801

Diagnostikbesteck kombiniert, komplett in Etui bestehend aus:

- 1 Griff Typ C für 2 Batterien oder 1 Accu (ohne Batterien/Accu)
- 1 Ophthalmoskop mit Halogenbirne 2,5 V
- 1 Otoskopkopf mit Halogenbirne 2,5 V
- je 1 wiederverwendbarer Ohrtrichter ø 2,0 mm, 3,0 mm, 4,0 mm und 5,0 mm, schwarz
- je 3 Einwegohrtrichter ø 2,0 mm und 4,0 mm, blau
- 1 Operationslinse, 4-fach vergrößernd
- 2 Ersatzbirnchen, Halogen 2,5 V

Juego Diagnóstico, combinado, completo en estuche compuesto de:

- 1 mango de pilas tipo C (sin pilas)
- 1 oftalmoscopio con bombilla de halógeno 2,5 V
- 1 cabeza de otoscopio con bombilla de halógeno 2,5 V
- 1 de c. u. espéculos auriculares reutilizables ø 2,0 mm, 3,0 mm, 4,0 mm y 5,0 mm, negros
- 3 de c. u. espéculos auriculares desechables ø 2,0 mm y 4,0 mm, azules
- 1 lente para operaciones, aumento 4 x
- 2 bombillas de repuesto, halógeno 2,5 V

Diagnostic Set, combined, complete in case consisting of:

- 1 battery handle (without batteries)
- 1 ophthalmoscope with halogen bulb 2,5 V
- 1 otoscope head with halogen bulb 2,5 V
- 1 each reusable ear specula ø 2,0 mm, 3,0 mm, 4,0 mm and 5,0 mm, black
- 3 each disposable ear specula ø 2,0 mm and 4,0 mm, blue
- 1 magnifying lens for operations, 4 x
- 2 spare bulb, halogen 2,5 V

Set per diagnostica, combinato, completo in astuccio composto da:

- 1 manico per pila tipo C (senza pila)
- 1 oftalmoscopio con lampadina alogena 2,5 V
- 1 testa di otoscopio con lampadina alogena 2,5 V
- 1 ognuno specoli auricolari riutilizzabili ø 2,0 mm, 3,0 mm, 4,0 mm e 5,0 mm, nero
- 3 ognuno specoli auricolari ø 2,0 mm e 4,0 mm, azzurro
- 1 lente per operazione, ingrandimento 4 x
- 2 lampadina di ricambio, alogena 2,5 V



Packung á 100 St.
 Package of 100 pcs.
 Paquete de 100 piezas
 Confezione da 100 pezzi



Packung á 10 St.
 Package of 10 pcs.
 Paquete de 10 piezas
 Confezione da 10 pezzi

		für/for/para/per	
1100-4818-20	Ø 2,0 mm	Ohr/ear/oido/orecchia	
1100-4818-30	Ø 3,0 mm	Ohr/ear/oido/orecchia	
1100-4818-40	Ø 4,0 mm	Ohr/ear/oido/orecchia	
1100-4818-50	Ø 5,0 mm	Ohr/ear/oido/orecchia	
1100-4818-90	Ø 9,0 mm	Nase/nose/nariz/naso	
blau	zum Einmalgebrauch		
blue	disposable		
azul	desechable		
azzurro	monouso		

		für/for/para/per	
1100-4801-20	Ø 2,0 mm	Ohr/ear/oido/orecchia	
1100-4801-30	Ø 3,0 mm	Ohr/ear/oido/orecchia	
1100-4801-40	Ø 4,0 mm	Ohr/ear/oido/orecchia	
1100-4801-50	Ø 5,0 mm	Ohr/ear/oido/orecchia	
1100-4801-90	Ø 9,0 mm	Nase/nose/nariz/naso	
schwarz	wiederverwendbar		
black	reusable		
negro	reutilizable		
nero	riutilizzabile		



1100-4801-01
 Batteriehandgriff
 Battery Handle
 Mango de batería
 Manico per pile



Packung á 6 St.
 Package of 6 pcs.
 Paquete de 6 piezas
 Confezione da 6 pezzi

1100-4800-01 2,5 V
 Ersatzbirnchen, Halogen für Otoskop
 Spare bulb, halogen for otoscope
 Bombilla de repuesto, halógeno para otoscopio
 Lampadina di ricambio, alogeno per otoscopio



Packung á 6 St.
 Package of 6 pcs.
 Paquete de 6 piezas
 Confezione da 6 pezzi

1100-4800-02 2,5 V
 Ersatzbirnchen, Halogen für Ophthalmoskop
 Spare bulb, halogen for ophthalmoscope
 Bombilla de repuesto, halógeno para oftalmoscopio
 Lampadina di ricambio, alogeno per oftalmoscopio



1100-4802-10
 Otoskopkopf mit Halogenbirne 2,5 V
 Otoscope head with halogen bulb 2,5 V
 Cabeza de otoscopio con bombilla de halógeno 2,5 V
 Testa di otoscopio con lampadina alogena 2,5 V



1100-4802-20
 Ophthalmoskopkopf mit Halogenbirne 2,5 V
 Ophthalmoscope head with halogen bulb 2,5 V
 Cabeza de oftalmoscopio con bombilla de halógeno 2,5 V
 Testa di oftalmoscopio con lampadina alogena 2,5 V

**ZIEGLER****1100-4900** Ø 90 mm

Stirnspiegel mit schwarzem Plastikband
Head mirror with black plastic head band
Espejo frontal con banda de plastico negro
Specchio frontale con fascia di plastica nera

ZIEGLER**1100-4901** Ø 90 mm

Stirnspiegel mit weißem Plastikband
Head mirror with white plastic head band
Espejo frontal con banda de plastico blanca
Specchio frontale con fascia di plastica bianca

**ZIEGLER****1100-4917** Ø 90 mm**ZIEGLER**

1100-4918 schwarz/black/negra/nera
1100-4919 weiß/white/blanca/bianca

weißes Celluloid
white celluloid
celoloido blanco
celloide bianco

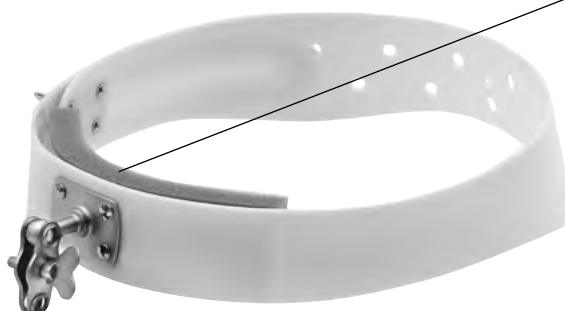
**1100-4916**

Ersatz-Schaumgummipolsterung für Stirnband
Spare foam rubber pad for head band
Almohadilla de espuma de repuesto para cinta frontal
Imbottitura frontale per fascia frontale

1100-4915

1100-4916

Ersatz-Schaumgummipolsterung für Stirnband
Spare foam rubber pad for head band
Almohadilla de espuma de repuesto para cinta frontal
Imbottitura frontale per fascia frontale



CLAR
1100-4202 6 Volt



CLAR
1101-4201 Ø 55 mm

mit Fassung
with socket
con montura
con montatura

weißes Celluloid
white celluloid
celoideo blanco
celloido bianco



1100-4204



1100-4205 6 Volt

1100-4916

Ersatz-Schaumgummipolsterung für Stirnband
Spare foam rubber pad for head band
Almohadilla de espuma de repuesto para cinta frontal
Imbottitura frontale per fascia frontale

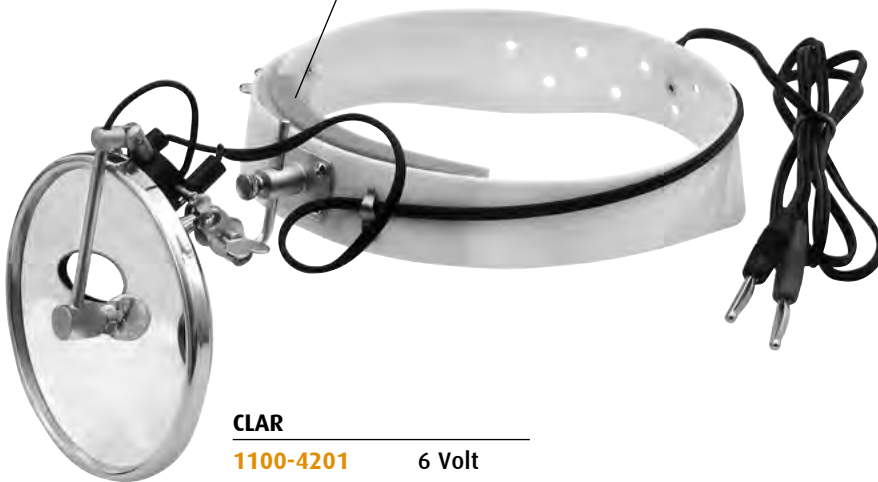

CLAR

1100-4201 6 Volt

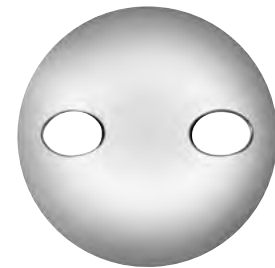

Spiegel, allein
mirror, only
espejo, suelto
specchio, solo

CLAR

1100-4299 Ø 100 mm

weißes Celluloid
white celluloid
celoideo blanco
celloide bianco



1100-4300



1100-4205 6 Volt

stufenlos regulierbar 0-10 Volt
continuously adjustable 0-10 volt
regulacion continua 0-10 voltios
regolazione continua 0-10 Volt



1100-4209



BERGER

1100-4220

binokular
 auswechselbare Linsen,
 aufklappbar
 Vergrößerung 2,5 x
 binocular exchangeable lenses.
 hinged housing
 magnifying power 2,5 x
 binocular lentes intercambiables,
 ajustable
 aumento 2,5 x
 binocularare lenti intercambiabili,
 regolabili
 ingrandimento 2,5 x



BERGER	Binokular, Arbeitsabstand binocular, free working distance binocular, distancia de trabajo binocularare, distanza di osservazione	Vergrößerung magnifying power aumento ingrandimento
1100-4221	220 mm = 4,0 Diop.	1,5 x
1100-4222	170 mm = 5,5 Diop.	2,0 x
1100-4223	130 mm = 7,0 Diop.	2,5 x
1100-4224	100 mm = 8,5 Diop.	3,0 x

1100-4100

Tischmodell - mit Nylon-Klettmanschette (1100-4101),
 Quecksilberröhre 300 mm

Desk Model - with nylon velcro cuff (1100-4101),
 mercury tube 300 mm

Modelo-Sobremesa - con brazelete de nylon con velcro
 1100-4101), tubo de mercurio 300 mm

Modello tavolo - con bracciale velcro-nylon (1100-4101),
 tubo a mercurio 300 mm



1100-4101

Nylon-Klettmanschette für Erwachsene mit
 Latexpolster, 2-Schlauch, 54,5 cm x 14,5 cm
 Nylon velcro cuff for adults with 2-tube latex
 bladder 54,5 cm x 14,5 cm

Brazelete de nylon-velcro para adultos con
 bolsa de látex de 2 tubos 54,5 cm x 14,5 cm
 Bracciale velcro-nylon per adulti con camera
 d'aria in lattice a 2 tubi, 54,5 cm x 14,5 cm



1100-4102

Nylon-Klettmanschette für Erwachsene mit
 Latexpolster, 1-Schlauch, 54,5 cm x 14,5 cm
 Nylon velcro cuff for adults with 1-tube latex
 bladder 54,5 cm x 14,5 cm

Brazelete de nylon-velcro para adultos con
 bolsa de látex de 1 tubos 54,5 cm x 14,5 cm
 Bracciale velcro-nylon per adulti con camera
 d'aria in lattice a 1 tubi, 54,5 cm x 14,5 cm

1100-3901

in Tasche - mit Nylon-Klettmanschette (1100-4102)

in bag - with nylon velcro cuff (1100-4102)

en bolso - con brazelete de nylon con velcro (1100-4102)

in borsa - con bracciale velcro-nylon (1100-4102)



1100-3902

Manometer mit Gummiball
Manometer with rubber bulb
Manómetro con pera de goma
Manometro con pallone in gomma



1100-4103

Wandmodell - mit Nylon-Klettmanschette
(1100-4103), Quecksilberröhre 300 mm
Wall Model - with nylon velcro cuff
(1100-4103), mercury tube 300 mm
Modelo pared - con brazelete de nylon con velcro
(1100-4103), tubo de mercurio 300 mm
Modello parete - con bracciale velcro-nylon
(1100-4103), tubo a mercurio 300 mm



1360-0115



1360-0117



1360-0120

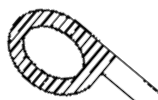

1360-0125

MAGILL

1360-0115	15,0 cm / 6"
1360-0117	17,0 cm / 6 ³ / ₄ "
1360-0120	20,0 cm / 8"
1360-0125	25,0cm / 9 ³ / ₄ "

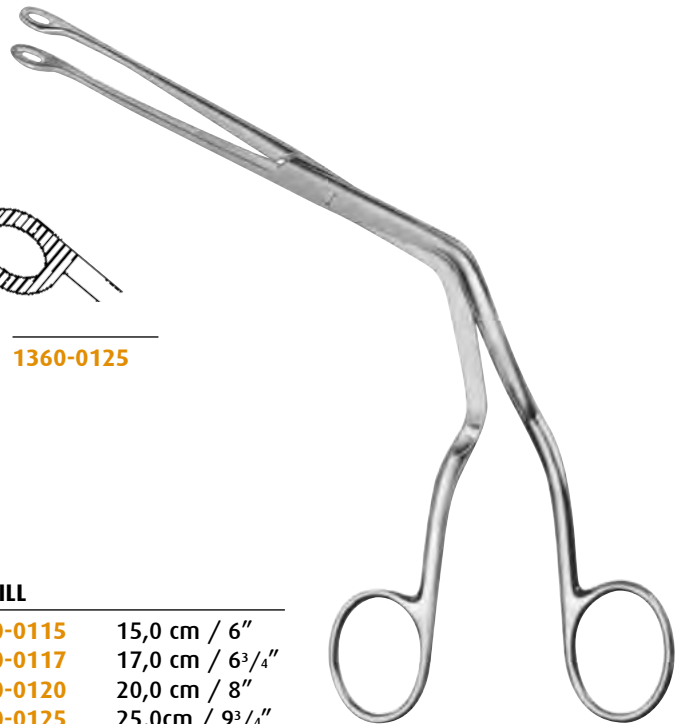



MILLER-BABY

1100-7200

mit Batterie-Handgriff (ohne Batterien)
und zwei Laryngoskopspatel Fig. 0 und 1,
komplett, in Etui

with battery handle (without batteries)
and two laryngoscope blades fig. 0 and 1,
complete, in case

con mango de pilas (sin pilas) y dos
hojas de laringoscopio fig. 0 y 1
completo, en estuche

con manico a pila (senza pila) é due
spatole per laringoscopia fig. 0 é 1,
completo, in scatola

MILLER

1100-7300

mit Batterie-Handgriff (ohne Batterien)
und drei Laryngoskopspatel Fig. 1 bis 3,
komplett, in Etui

with battery handle (without batteries)
and three laryngoscope blades fig. 1 to 3,
complete, in case

con mango de pilas (sin pilas) y tres
hojas de laringoscopio fig. 1 a 3
completo, en estuche

con manico a pila (senza pila) é tre
spatole per laringoscopia fig. 1 a 3,
completo, in scatola

MILLER

1100-7400

mit Batterie-Handgriff (ohne Batterien)
und vier Laryngoskopspatel Fig.1 bis 4,
komplett, in Etui

with battery handle (without batteries)
and four laryngoscope blades fig. 1 to 4,
complete, in case

con mango de pilas (sin pilas) y cuatro
hojas de laringoscopio fig. 1 a 4
completo, en estuche

con manico a pila (senza pila) é quattro
spatole per laringoscopia fig. 1 a 4,
completo, in scatola

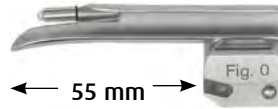

MILLER

1100-5100

Fig.0
 für Säuglinge
 for babies
 para bebès
 per neonati

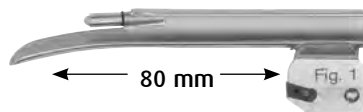

MILLER

1100-5101

Fig.1
 für Kinder
 for children
 para niños
 per bambini

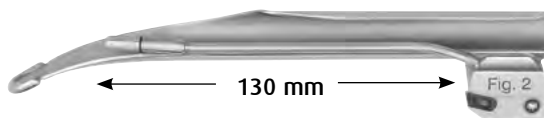

MILLER

1100-5102

Fig.2
 für Jugendliche
 for adolescent
 para adolescentes
 per adolescenti

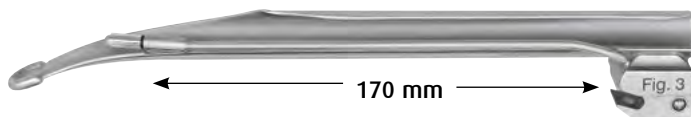

MILLER

1100-5103

Fig.3
 für Frauen
 for women
 para mujeres
 per donne



MILLER

1100-5104

Fig.4
 für Männer
 for men
 para hombres
 per uomini



GUEDEL-NEGUS

1100-7500

mit Batterie-Handgriff (ohne Batterien) und drei Laryngoskopspatel Fig. 2 bis 4, komplett, in Etui

with battery handle (without batteries) and three laryngoscope blades fig. 2 to 4, complete, in case

con mango de pilas (sin pilas) y tres hojas de laringoscopio fig. 2 a 4 completo, en estuche

con manico a pila (senza pila) é due spatole per laringoscopia fig. 2 a 4, completo, in scatola

GUEDEL-NEGUS

1100-7510

mit Batterie-Handgriff (ohne Batterien) und vier Laryngoskopspatel Fig. 1 bis 4, komplett, in Etui

with battery handle (without batteries) and two laryngoscope blades fig. 1 to 4, complete, in case

con mango de pilas (sin pilas) y dos hojas de laringoscopio fig. 1 a 4 completo, en estuche

con manico a pila (senza pila) é due spatole per laringoscopia fig. 1 a 4, completo, in scatola



1100-7501

Fig.1
 für Kinder
 for children
 para niños
 per bambini



1100-7502

Fig.2
 für Jugendliche
 for adolescent
 para adolescentes
 per adolescenti



1100-7503

Fig.3
 für Frauen
 for women
 para mujeres
 per donne



1100-7504

Fig.4
 für Männer
 for men
 para hombres
 per uomini



MC INTOSH

1100-7600

mit Batterie-Handgriff (ohne Batterien) und drei Laryngoskopspatel Fig. 1 bis 3, komplett, in Etui

with battery handle (without batteries) and three laryngoscope blades fig. 1 to 3, complete, in case

con mango de pilas (sin pilas) y tres hojas de laringoscopio fig. 1 a 3 completo, en estuche

con manico a pila (senza pila) e due spatole per laringoscopia fig. 1 a 3, completo, in scatola

MC INTOSH

1100-7700

mit Batterie-Handgriff (ohne Batterien) und vier Laryngoskopspatel Fig. 1 bis 4, komplett, in Etui

with battery handle (without batteries) and two laryngoscope blades fig. 1 to 4, complete, in case

con mango de pilas (sin pilas) y dos hojas de laringoscopio fig. 1 a 4 completo, en estuche

con manico a pila (senza pila) e due spatole per laringoscopia fig. 1 a 4, completo, in scatola



1100-5200

Fig.0
für Säuglinge
for babies
para bebés
per neonati



1100-5201

Fig.1
für Kinder
for children
para niños
per bambini



1100-5202

Fig.2
für Jugendliche
for adolescent
para adolescentes
per adolescenti



1100-5203

Fig.3
für Frauen
for women
para mujeres
per donne



1100-5204

Fig.4
für Männer
for men
para hombres
per uomini



FOREGGER

1100-7080

mit Batterie-Handgriff (ohne Batterien) und drei Laryngoskopspatel Fig.1 bis 3, komplett, in Etui

with battery handle (without batteries) and three laryngoscope blades fig. 1 to 3, complete, in case

con mango de pilas (sin pilas) y tres hojas de laringoscopio fig. 1 a 3 completo, en estuche

con manico a pila (senza pila) é due spatole per laringoscopia fig. 1 a 3, completo, in scatola

FOREGGER

1100-7090

mit Batterie-Handgriff (ohne Batterien) und vier Laryngoskopspatel Fig. 0 bis 3, komplett, in Etui

with battery handle (without batteries) and two laryngoscope blades fig. 0 to 3, complete, in case

con mango de pilas (sin pilas) y dos hojas de laringoscopio fig. 0 a 3 completo, en estuche

con manico a pila (senza pila) é due spatole per laringoscopia fig. 0 a 3, completo, in scatola



1100-5300

Fig.0
für Kinder
for children
para niños
per bambini



1100-5301

Fig.1
für Jugendliche
for adolescent
para adolescentes
per adolescenti



1100-5302

Fig.2
für Frauen
for women
para mujeres
per donne



1100-5303

Fig.3
für Männer
for men
para hombres
per uomini



1100-6200

Batteriehandgriff
Battery Handle
Mango de pilas
Manico per pila



1100-6100

Batteriehandgriff
Battery Handle
Mango de pilas
Manico per pila



1100-6000

Batteriehandgriff
Battery Handle
Mango de pilas
Manico per pila



1100-6311

2,5V

Ersatzlampe klein
für Spatel Fig. 0 bis 1
Spare Bulb small,
for blades fig. 0 to 1
Bombilla de recambio pequeño,
para hojas fig. 0 á 1
Lampadina di ricambio piccolo,
per spatola fig. 2 fino a 4



1100-6312

2,5 V

Ersatzlampe groß
für Spatel Fig. 2 bis 4
Spare Bulb large,
for blades fig. 2 to 4
Bombilla de recambio grande,
para hojas fig. 2 á 4
Lampadina di ricambio grande,
per spatola fig. 2 fino a 4



verstellbar
adjustable
ajustable
regolabili

1100-5600

Fig. 2 - 4

Der Teleskop-Laryngoskopspatel ist die Konsequenz aus den Erfahrungen mehrjähriger notärztlicher Tätigkeit. Die Notwendigkeit der Intubation ergibt sich nur bei einem kleinen Prozentsatz der Einsatzfälle. Dann muss sie jedoch schnell und sicher erfolgen können! Die bisherige Methode mit mehreren Laryngoskopspatelgrößen nimmt viel Volumen in Rettungskoffer ein und trägt erheblich zu dessen Gewicht bei.

Wird dem Notarzt bei der Intubation der falsche (insbesondere zu kleine) Laryngoskop angereicht, muss evtl. nach frustriertem Intubationsversuch, ein relativ zeitraubender Spatelwechsel erfolgen.

Jetzt besteht das Hauptrisiko für Hypoxämie und Aspiration für den Patienten!

Der Teleskop-Laryngoskopspatel erlaubt die sichere Intubation mit sofortiger Verstellmöglichkeit der Spatellänge durch den Notarzt. Sein Volumen- und Gewichtsanteil im Rettungskoffer ist deutlich geringer. Dies führt zur Steigerung der Einsatzfähigkeit des Rettungsteams bei der Boden-, See- und insbesondere aber auch bei der Luftrettung.

The Telescope Laryngoscope Blade is the consequence of the experiences of emergency doctor for years.

An intubation is only necessary at a small percentage of the cases of emergency. But then it has to be effected quickly and safe! The present method with various sizes of Laryngoscope blades needs many space in the rescue suitcase and it makes it very heavy. If the emergency doctor gets the wrong blade at the intubation (especially if the blade is too small) a change of blades has to be effected, probably after a futile trials of intubation which is very time consuming.

Now is the main risk for hypoxemia and aspiration for patient!

With the Telescope Laryngoscope Blade the emergency doctor is able to make a safe intubation with the possibility of an immediate adjustment of the length of the blade. The volume and the weight of the rescue suitcase is definitely lower. This aspect diate adjustment of the length of the blade. The volume and the weight of the rescue suitcase is definitely lower. This aspect leads to an increase of the capability of the rescue team on ground, at sea and especially in the air.

El Laringoscopio telescopico es la consecuencia de las experiencias de medicos de urgencias durante años.

Una intubación es sólo necesario en un pequeño porcentaje de los casos de emergencia. El método presente con varios tamaños de hojas de Laringoscopios necesita mucho espacio en la maleta de rescate y esto la hace muy pesada.

Si se le entrega al medico de urgencias la hoja incorrecta para la intubación (sobre todo si la hoja es demasiado pequeña) un cambio de hoja tiene que ser efectuado, probablemente tras un intento vano de intubación que requiere mucho tiempo.

Ahora es el riesgo principal para hipoxemia y aspiración para el paciente!

El Laringoscopio telescopico permite al medico de urgencias una intubación segura con la posibilidad de un ajuste inmediato de la longitud de la hoja. El volumen y el peso de la maleta de rescate son definitivamente inferiores. Este aspecto conduce a un aumento de la capacidad del equipo de rescate sobre la tierra, en el mar y sobre todo en el aire.

Il Laringoscopio telescopico è la conseguenza dalle esperienze di dottori di emergenza per anni. Una intubazione è solamente necessario ad una piccola percentuale dei casi di emergenza. Il metodo presente con le varie taglie delle lame di Laringoscopio ha bisogno di molto spazio nella valigia di liberazione e lo fa molto pesante. Se il dottore di emergenza trova la lama sbagliata all'intubazione (specialmente se la lama è troppo piccola) un cambio di lame doveva essere effettuato, probabilmente dopo un triale futile di intubazione che richiede molto tempo.

Ora è il rischio principale per hipoxemia e l'aspirazione per il paziente!

Col il Laringoscopio telescopico il dottore di emergenza è capace di fare un intubazione sicura con la possibilità di una rettifica immediata della lunghezza della lama. Il volume ed il peso della valigia di liberazione sono definitivamente più bassi. Questo aspetto conduce ad un aumento della capacità della squadra di soccorso su terra, a mare e specialmente nell'aria.



Laryngoskopiebestecke Kaltlicht
 Laryngoscope Sets fiber optic
 Juegos de laringoscopios luz fria
 Set per laringoscopia luce fredda

MILLER

1100-8300

mit Batterie-Handgriff (ohne Batterie)
 und drei Laryngoskopspatel
 Fig. 1 bis 3, komplett, in Etui
 with battery handle (without batteries)
 and three laryngoscope blades
 fig. 1 to 3, complete, in case
 con mango de pilas (sin pilas)
 y tres hojas de laringoscopio
 fig. 1 a 3 completo, en estuche
 con manico a pila (senza pila)
 è tre spatole per laringoscopia
 fig. 1 fino a 3, completo, in scatola

MILLER

1100-8400

mit Batterie-Handgriff (ohne Batterie)
 und vier Laryngoskopspatel
 Fig. 1 bis 4, komplett, in Etui
 with battery handle (without batteries)
 and four laryngoscope blades
 fig. 1 to 4, complete, in case
 con mango de pilas (sin pilas)
 y cuatro hojas de laringoscopio
 fig. 1 a 4 completo, en estuche
 con manico a pila (senza pila)
 è quattro spatole per laringoscopia fig. 1
 fino a 4, completo, in scatola



MILLER

1100-5500

Fig.0
 für Säuglinge
 for babies
 para bebés
 per neonati



MILLER

1100-5501

Fig.1
 für Kinder
 for children
 para niños
 per bambini

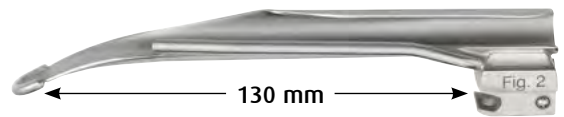

MILLER

1100-5502

Fig.2
 für Jugendliche
 for adolescent
 para adolescentes
 per adolescenti



MILLER

1100-5503

Fig.3
 für Frauen
 for women
 para mujeres
 per donne



MILLER

1100-5504

Fig.4
 für Männer
 for men
 para hombres
 per uomini

Laryngoskopiebestecke Kaltlicht
Laryngoscope Sets fiber optic
Juegos de laringoscopios luz fria
Set per laringoscopia luce fredda



MCINTOSH

1100-8100

mit Batterie-Handgriff (ohne Batterie)
und drei Laryngoskopspatel
Fig. 1 bis 3,
komplett, in Etui

with battery handle (without batteries)
and three laryngoscope blades
fig. 1 to 3,
complete, in case

con mango de pilas (sin pilas)
y tres hojas de
laringoscopio fig. 1 a 3
completo, en estuche

con manico a pila (senza pila)
è tre spatole per
laringoscopia fig. 1 fino a 3,
completo, in scatola

MCINTOSH

1100-8200

mit Batterie-Handgriff (ohne Batterie)
und vier Laryngoskopspatel
Fig. 1 bis 4,
komplett, in Etui

with battery handle (without batteries)
and four laryngoscope blades
fig. 1 to 4,
complete, in case

con mango de pilas (sin pilas)
y cuatro hojas de
laringoscopio fig. 1 a 4
completo, en estuche

con manico a pila (senza pila)
è quattro spatole per
laringoscopia fig. 1 fino a 4,
completo, in scatola

**MCINTOSH****1100-5400**

Fig.0
 für Säuglingen
 for babies
 para bebés
 per neonati

**MCINTOSH****1100-5401**

Fig.1
 für Kinder
 for children
 para niños
 per bambini

**MCINTOSH****1100-5402**

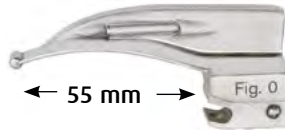
Fig.2
 für Jugendliche
 for adolescent
 para adolescentes
 per adolescenti

**MCINTOSH****1100-5403**

Fig.3
 für Frauen
 for women
 para mujeres
 per donne

**MCINTOSH****1100-5404**

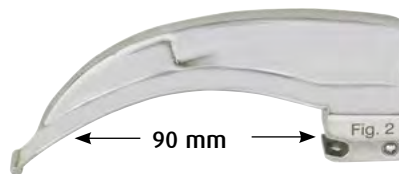
Fig.4
 für Männer
 for men
 para hombres
 per uomini

Laryngoskopiebestecke Kaltlicht
Laryngoscope Sets fiber optic
Juegos de laringoscopios luz fria
Set per laringoscopia luce fredda



FOREGGER

1100-8010

mit Batterie-Handgriff (ohne Batterie)
und drei Laryngoskopspatel
Fig. 2 bis 4,
komplett, in Etui

with battery handle (without batteries)
and three laryngoscope blades
fig. 2 to 4,
complete, in case

con mango de pilas (sin pilas)
y tres hojas de
laringoscopio fig. 2 a 4
completo, en estuche

con manico a pila (senza pila)
è tre spatole per
laringoscopia fig. 2 fino a 4,
completo, in scatola

FOREGGER

1100-8020

mit Batterie-Handgriff (ohne Batterie)
und vier Laryngoskopspatel
Fig. 1 bis 4,
komplett, in Etui

with battery handle (without batteries)
and four laryngoscope blades
fig. 1 to 4,
complete, in case

con mango de pilas (sin pilas)
y cuatro hojas de
laringoscopio fig. 1 a 4
completo, en estuche

con manico a pila (senza pila)
è quattro spatole per
laringoscopia fig. 1 fino a 4,
completo, in scatola

**FOREGGER****1100-8011**

Fig.0
 für Säuglingen
 for babies
 para bebés
 per neonati

**FOREGGER****1100-8012**

Fig.1
 für Kinder
 for children
 para niños
 per bambini

**FOREGGER****1100-8013**

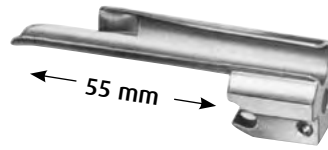
Fig.2
 für Jugendliche
 for adolescent
 para adolescentes
 per adolescenti

**FOREGGER****1100-8014**

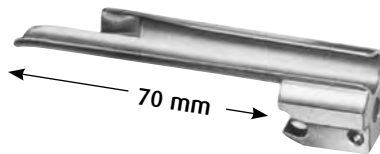
Fig.3
 für Frauen
 for women
 para mujeres
 per donne

**FOREGGER****1100-8015**

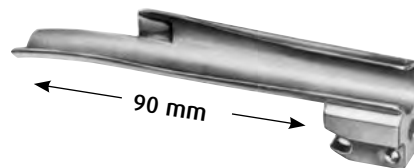
Fig.4
 für Männer
 for men
 para hombres
 per uomini

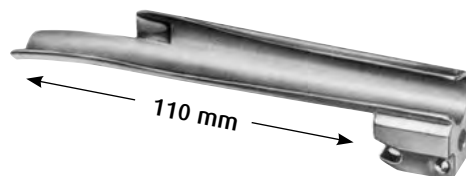

1100-6500

Batteriehandgriff (ohne Batterie)
mit Halogenlampe und grünem Ring

Battery handle (without batteries)
with halogen bulb and green ring

Mango de pilas (sin pilas)
con bombilla de halogeno y anillo verde

Manico a pila (senza pila)
con lampadina di alogeno e anello verde



1100-6400

Batteriehandgriff (ohne Batterie)
mit Halogenlampe und grünem Ring

Battery handle (without batteries)
with halogen bulb and green ring

Mango de pilas (sin pilas)
con bombilla de halogeno y anillo verde

Manico a pila (senza pila)
con lampadina di alogeno e anello verde



1100-6900

Ersatzlampe
Spare Bulb
Bombilla de recambio
Lampadina di ricambio
Krypton 2,5 V



1100-6902

Ersatzlampe
Spare Bulb
Bombilla de recambio
Lampadina di ricambio
Xenon 2,5 V



1100-6901

Ersatzlampe
Spare Bulb
Bombilla de recambio
Lampadina di ricambio
Halogen 2,5 V



1100-6600

Kaltlichtgriff mit LED-Beleuchtung
Fiber optic Handle with LED-illumination
Mango con iluminaci3n LED para luz fria
Manico con illuminazione LED per luce fredda



1100-6601 220 V

Ladestation für Kaltlichtgriff 1100-6600
Charging station for Fiberoptic handle 1100-6600
Cargador para mango para luz fria 1100-6600
Caricatore per manico per luce fredda 1100-6600

Operations-Laryngoskope mit Fiberglas-Lichtträger
Operating Laryngoscopes with Fiber Optic Light Carrier
Laringoscopios para operaciones con portadores de luz fibra óptica
Laringoscopi a sospensione con supporto per illuminazione fibra ottica

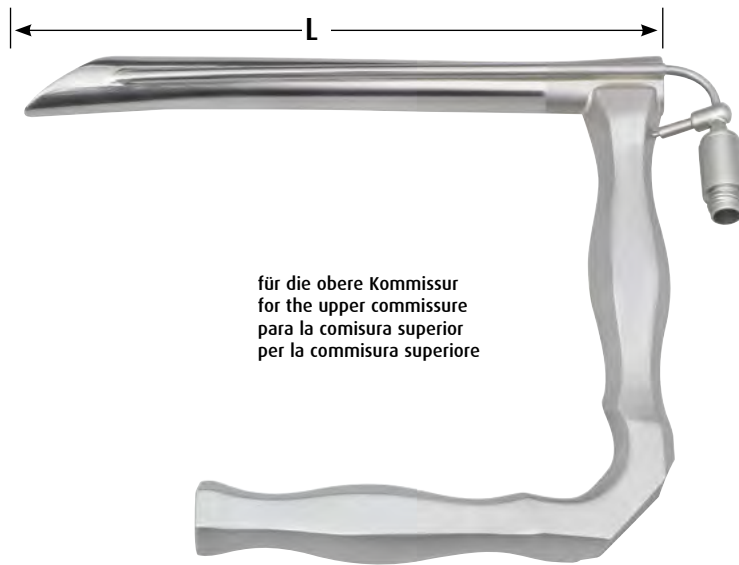

für die obere Kommissur
 for the upper commissure
 para la comisura superior
 per la commisura superiore

HOLINGER	L	
1100-9000	171 mm	1100-9011
1100-9010	180 mm	1100-9012

Ersatz-Lichtträger
 Spare light carriers
 Portadores de luz de repuesto
 Supporte per illuminazione di ricambio

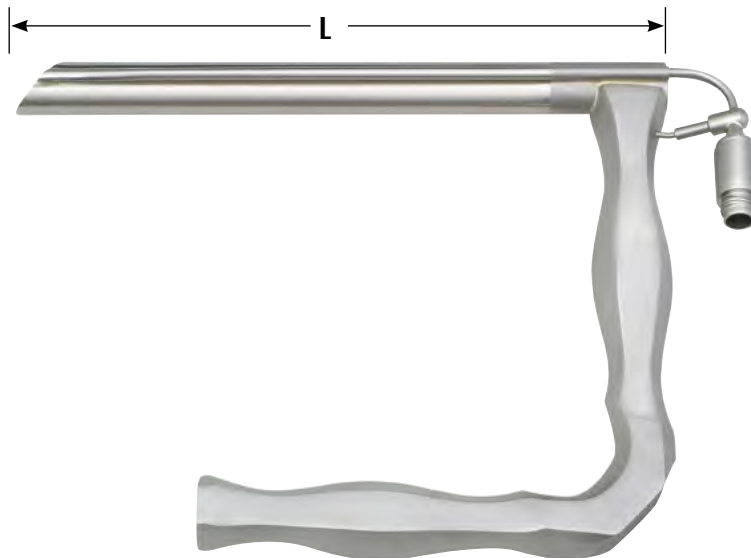

JACKSON	L	
1100-9120	120 mm	1100-9100
1100-9170	170 mm	1100-9200
1100-9180	180 mm	1100-9300

Ersatz-Lichtträger
 Spare light carriers
 Portadores de luz de repuesto
 Supporte per illuminazione di ricambio



	Art.-Nr. Cat.-No. Nº de artículo Nº di articolo	Figur Figure Figura Figura	Länge Lenght Largura Lunghezza	für for para per	Ersatz-Lichtträger Spare light carriers Portadores de luz de repuesto Supporte p. illuminazione di ricambio
	1262-8201	1	135 mm	Kleinkinder / infants / párvulos / infante	1262-8301
	1262-8202	2	152 mm	Kinder / children / niños / bambini	1262-8301
	1262-8203	3	182 mm	Erwachsene / adults / adultos / adulti	1262-8302
	1262-8204	4	172 mm	Erwachsene / adults / adultos / adulti	1262-8302
	1262-8205	5	172 mm	Erwachsene / adults / adultos / adulti	1262-8302
	1262-8206	6	182 mm	Erwachsene / adults / adultos / adulti	1262-8302
	1262-8207	7	222 mm	Erwachsene / adults / adultos / adulti	1262-8303

Operations-Laryngoskope mit Fiberglas-Lichtträger
Operating Laryngoscopes with Fiber Optic Light Carrier
Laringoscopios para operaciones con portadores de luz fibra òptica
Laringoscopi a sospensione con supporto per illuminazione fibra ottica

spreizbar
spreadable
plegable
divaricabile



	Art.-Nr. Cat.-No Nº de artículo Nº di articolo	Figur Figure Figura Figura	Länge Lenght Largura Lunghezza	für for para per	Ersatz-Lichtträger Spare light carriers Portadores de luz de repuesto Supporte p. illuminazione di ricambio
	1262-8211	1	135 mm	Kleinkinder / infants / pàrvulos / infante	1262-8301
	1262-8212	2	152 mm	Kinder / children / niños / bambini	1262-8301
	1262-8213	3	182 mm	Erwachsene / adults / adultos / adulti	1262-8302
	1262-8214	4	172 mm	Erwachsene / adults / adultos / adulti	1262-8302
	1262-8215	5	172 mm	Erwachsene / adults / adultos / adulti	1262-8302
	1262-8216	6	182 mm	Erwachsene / adults / adultos / adulti	1262-8302
	1262-8217	7	222 mm	Erwachsene / adults / adultos / adulti	1262-8303



mit innenliegendem Rauchabsaugrohr
 with smoke suction tube inside
 con tubo extractor de humo al interior
 con tubo aspiratore di fumo nell'interno

1262-8011 Fig.7 140 mm

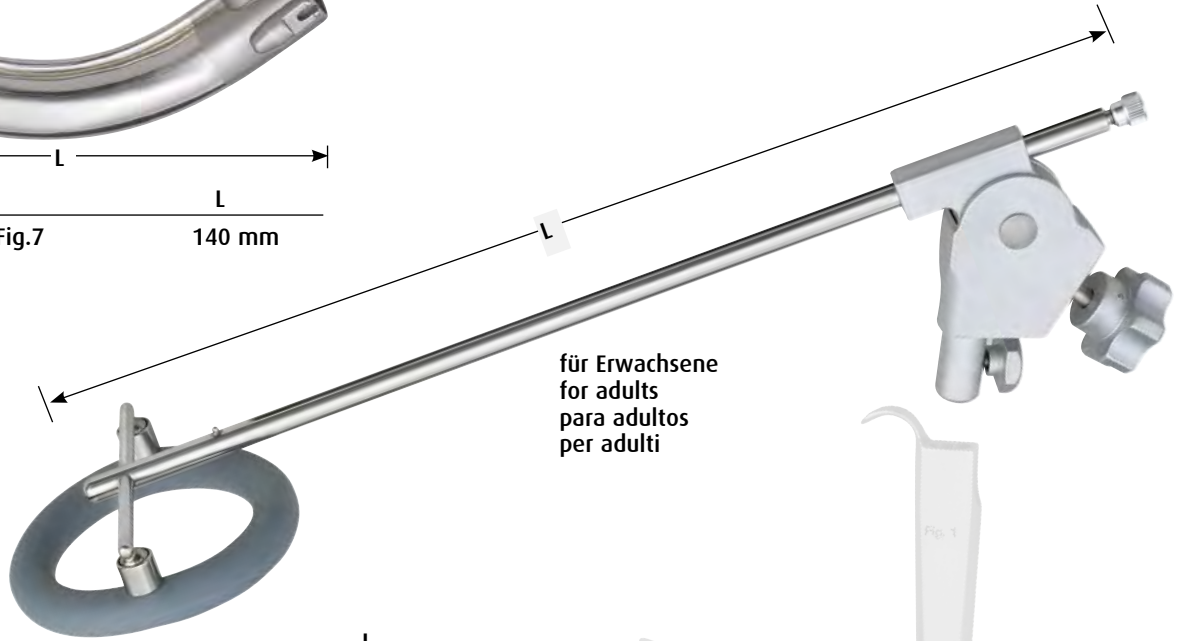

für Erwachsene
 for adults
 para adultos
 per adulti

1262-8002 34,0 cm

Bruststütze mit Laryngoskophalter
 Chest support with Laryngoscope holder
 Soporte de pecho con porta-laringoscopio
 Supporto sternale con porta-laringoscopi

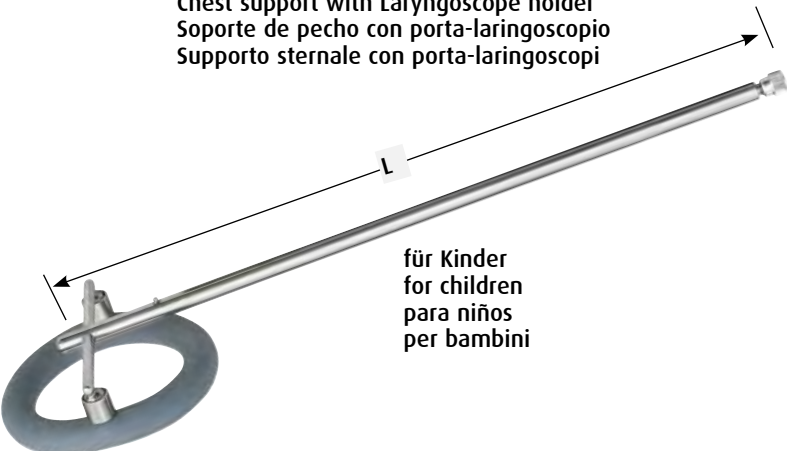

für Kinder
 for children
 para niños
 per bambini

1262-8001 24,0 cm

Bruststütze, allein
 Chest support, only
 Soporte de pecho, suelto
 Supporto sternale, solo



1262-8003

Laryngoskophalter, allein
 Laryngoscope holder, only
 Porta-laringoscopio, suelto
 Porta-laringoscopi, solo



1262-8301

Fiberglaslichtträger, klein, für Laryngoskope Fig. 1+ 2
Fiber optic Light carrier, small, for Laryngoscopes Fig. 1+ 2
Portador de luz fibra óptica, pequeño, para laringoscopios Fig. 1 + 2
Supporte per illuminazione, piccolo, per laringoscopi Fig. 1 + 2



1262-8302

Fiberglaslichtträger, mittel, für Laryngoskope Fig. 3 bis 6
Fiber optic Light carrier, medium, for Laryngoscopes Fig. 3 to 6
Portador de luz fibra óptica, mediano, para laringoscopios Fig. 3 hasta 6
Supporte per illuminazione, mezziano, per laringoscopi Fig. 3 a 6



1262-8303

Fiberglaslichtträger, groß, für Laryngoskope Fig. 7
Fiber optic Light carrier, large, for Laryngoscopes Fig. 7
Portador de luz fibra óptica, grande, para laringoscopios Fig. 7
Supporte per illuminazione, grande, per laringoscopi Fig. 7



1262-8500

Rauchabsaugrohr für Laryngoskope Fig. 3 bis 7
Smoke Suction tube for Laryngoscopes Fig. 3 to 7
Tubo extractor de humo para laringoscopios Fig. 3 hasta 7
Tubo aspiratore di fumo per laringoscopi Fig. 3 a 7



1262-8400

Injektionskanüle für Laryngoskope Fig. 3 bis 7
Injections Drain tube for Laryngoscopes Fig. 3 to 7
Injector para canulas para laringoscopios Fig. 3 hasta 7
Iniettore per cannule mezziano, per laringoscopi Fig. 3 a 7

019

**Naht
Suture
Sutura
Sutura**

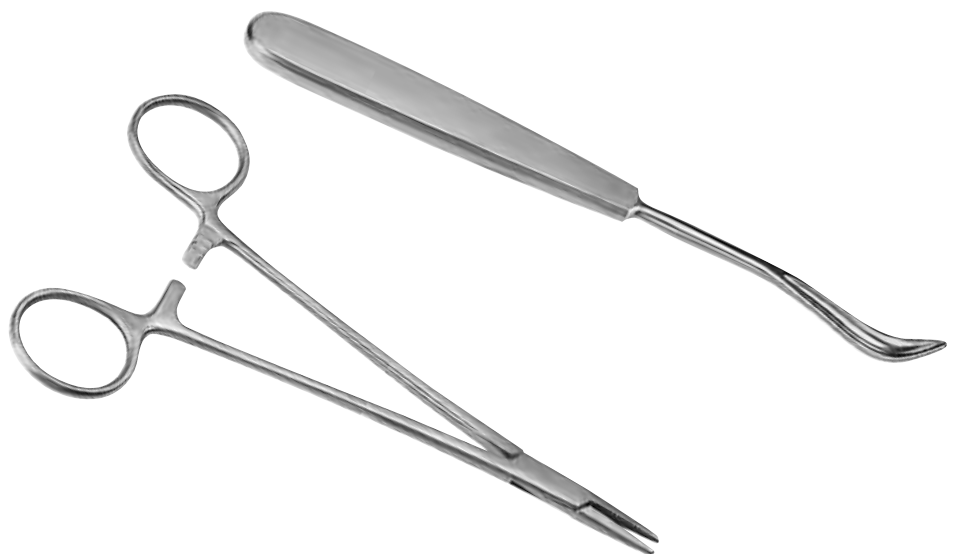

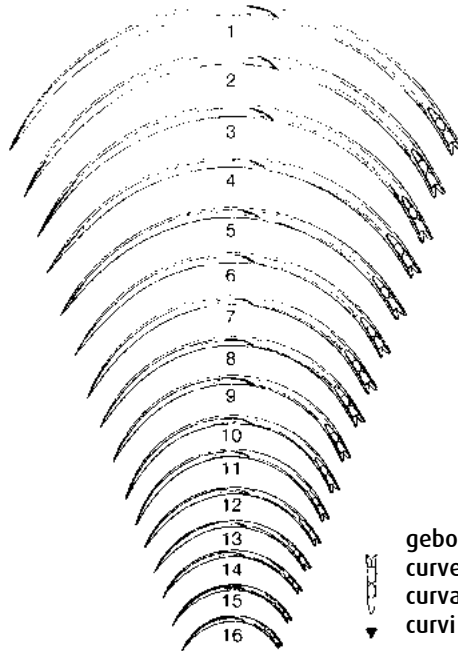
**B**

1178-0301	Fig. 1
1178-0302	Fig. 2
1178-0303	Fig. 3
1178-0304	Fig. 4
1178-0305	Fig. 5
1178-0306	Fig. 6
1178-0307	Fig. 7
1178-0308	Fig. 8
1178-0309	Fig. 9
1178-0310	Fig. 10
1178-0311	Fig. 11
1178-0312	Fig. 12
1178-0313	Fig. 13
1178-0314	Fig. 14
1178-0315	Fig. 15
1178-0316	Fig. 16

gebogen 3/8 Kreis
curved 3/8 circle
curvas 3/8 círculo
curvi 3/8 circolo

in Packungen zu 12 Stück
in packages of 12 pieces
en paquets de 12 piezas
in confezione da 12 pezzi

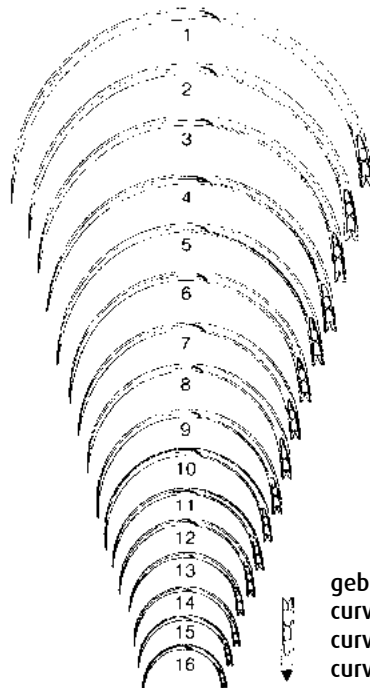
**G**

1178-1701	Fig. 1
1178-1702	Fig. 2
1178-1703	Fig. 3
1178-1704	Fig. 4
1178-1705	Fig. 5
1178-1706	Fig. 6
1178-1707	Fig. 7
1178-1708	Fig. 8
1178-1709	Fig. 9
1178-1710	Fig. 10
1178-1711	Fig. 11
1178-1712	Fig. 12
1178-1713	Fig. 13
1178-1714	Fig. 14
1178-1715	Fig. 15
1178-1716	Fig. 16

gebogen 1/2 Kreis
curved 1/2 circle
curvas 1/2 círculo
curvi 1/2 circolo

in Packungen zu 12 Stück
in packages of 12 pieces
en paquets de 12 piezas
in confezione da 12 pezzi

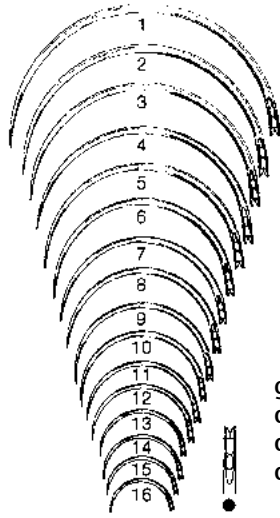

gebogen 1/2 Kreis
curved 1/2 circle
curvas 1/2 círculo
curvi 1/2 circolo

Gr

1178-1801	Fig. 1
1178-1802	Fig. 2
1178-1803	Fig. 3
1178-1804	Fig. 4
1178-1805	Fig. 5
1178-1806	Fig. 6
1178-1807	Fig. 7
1178-1808	Fig. 8
1178-1809	Fig. 9
1178-1810	Fig. 10
1178-1811	Fig. 11
1178-1812	Fig. 12
1178-1813	Fig. 13
1178-1814	Fig. 14
1178-1815	Fig. 15
1178-1816	Fig. 16

in Packungen zu 12 Stück
in packages of 12 pieces
en paquets de 12 piezas
in confezione da 12 pezzi

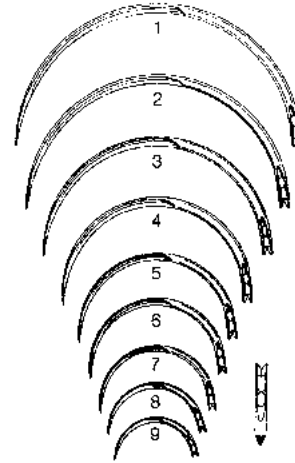

gebogen 1/2 Kreis
curved 1/2 circle
curvas 1/2 círculo
curvi 1/2 circolo

Ga

1178-1901	Fig. 1
1178-1902	Fig. 2
1178-1903	Fig. 3
1178-1904	Fig. 4
1178-1905	Fig. 5
1178-1906	Fig. 6
1178-1907	Fig. 7
1178-1908	Fig. 8
1178-1909	Fig. 9

in Packungen zu 12 Stück
in packages of 12 pieces
en paquets de 12 piezas
in confezione da 12 pezzi

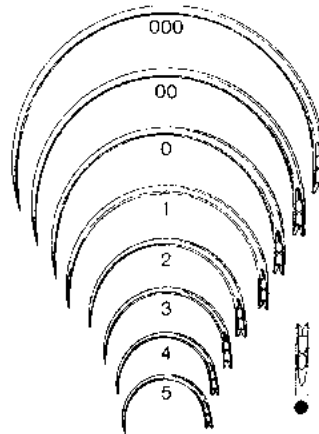

gebogen 1/2 Kreis
curved 1/2 circle
curvas 1/2 círculo
curvi 1/2 circolo

E

1178-2010	Fig. 0
1178-2020	Fig. 00
1178-2030	Fig. 000
1178-2011	Fig. 1
1178-2012	Fig. 2
1178-2013	Fig. 3
1178-2014	Fig. 4
1178-2015	Fig. 5

in Packungen zu 12 Stück
in packages of 12 pieces
en paquets de 12 piezas
in confezione da 12 pezzi

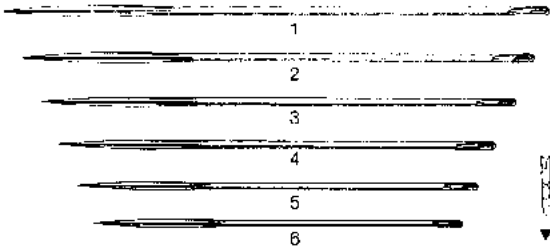

KEITH

- 1178-3001** Fig. 1 in Packungen zu 12 Stück
- 1178-3002** Fig. 2 in packages of 12 pieces
- 1178-3003** Fig. 3 en paquets de 12 piezas
- 1178-3004** Fig. 4 in confezione da 12 pezzi
- 1178-3005** Fig. 5
- 1178-3006** Fig. 6

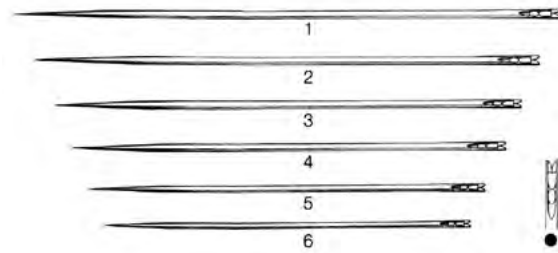

KEITH

- 1178-3101** Fig. 1 in Packungen zu 12 Stück
- 1178-3102** Fig. 2 in packages of 12 pieces
- 1178-3103** Fig. 3 en paquets de 12 piezas
- 1178-3104** Fig. 4 in confezione da 12 pezzi
- 1178-3105** Fig. 5
- 1178-3106** Fig. 6

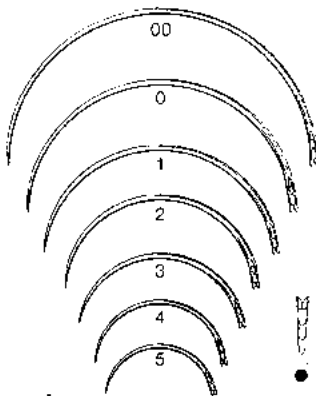

gebogen 1/2 Kreis
curved 1/2 circle
curvas 1/2 círculo
curvi 1/2 circolo

Pb

- 1178-5103** Fig. 0 in Packungen zu 12 Stück
- 1178-5102** Fig. 00 in packages of 12 pieces
- 1178-5301** Fig. 1 en paquets de 12 piezas
- 1178-5302** Fig. 2 in confezione da 12 pezzi
- 1178-5303** Fig. 3
- 1178-5304** Fig. 4
- 1178-5305** Fig. 5

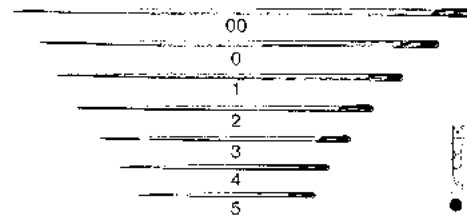

Pc

- 1178-5310** Fig. 0 in Packungen zu 12 Stück
- 1178-5320** Fig. 00 in packages of 12 pieces
- 1178-5401** Fig. 1 en paquets de 12 piezas
- 1178-5402** Fig. 2 in confezione da 12 pezzi
- 1178-5403** Fig. 3
- 1178-5404** Fig. 4
- 1178-5405** Fig. 5

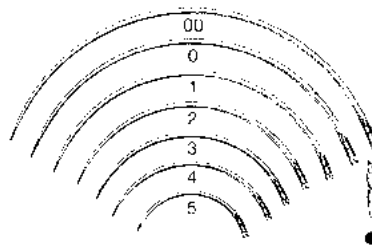

gebogen 3/8 Kreis
curved 3/8 circle
curvas 3/8 círculo
curvi 3/8 circolo

Pd

- 1178-5503** Fig. 0 in Packungen zu 12 Stück
- 1178-5502** Fig. 00 in packages of 12 pieces
- 1178-5701** Fig. 1 en paquets de 12 piezas
- 1178-5702** Fig. 2 in confezione da 12 pezzi
- 1178-5703** Fig. 3
- 1178-5704** Fig. 4
- 1178-5705** Fig. 5

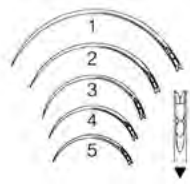

ob

- 1178-8301** Fig. 1
- 1178-8302** Fig. 2
- 1178-8303** Fig. 3
- 1178-8304** Fig. 4
- 1178-8305** Fig. 5

gebogen 3/8 Kreis
 curved 3/8 circle
 curvas 3/8 círculo
 curvi 3/8 circolo

in Packungen zu 12 Stück
 in packages of 12 pieces
 en paquetes de 12 piezas
 in confezione da 12 pezzi

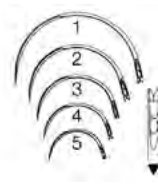

og

- 1178-8101** Fig. 1
- 1178-8102** Fig. 2
- 1178-8103** Fig. 3
- 1178-8104** Fig. 4
- 1178-8105** Fig. 5

gebogen 1/2 Kreis
 curved 1/2 circle
 curvas 1/2 círculo
 curvi 1/2 circolo

in Packungen zu 12 Stück
 in packages of 12 pieces
 en paquetes de 12 piezas
 in confezione da 12 pezzi

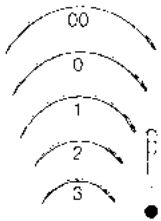

KALT

- 1178-7103** Fig. 0
- 1178-7102** Fig. 00
- 1178-7301** Fig. 1
- 1178-7302** Fig. 2
- 1178-7303** Fig. 3

gebogen 3/8 Kreis
 curved 3/8 circle
 curvas 3/8 círculo
 curvi 3/8 circolo

in Packungen zu 12 Stück
 in packages of 12 pieces
 en paquetes de 12 piezas
 in confezione da 12 pezzi

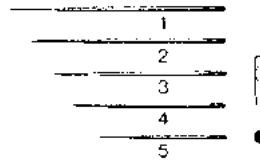

- 1178-7601** Fig. 1
- 1178-7602** Fig. 2
- 1178-7603** Fig. 3
- 1178-7604** Fig. 4
- 1178-7605** Fig. 5

in Packungen zu 12 Stück
 in packages of 12 pieces
 en paquetes de 12 piezas
 in confezione da 12 pezzi

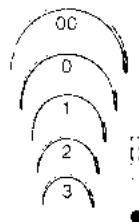

PAYR

- 1178-7703** Fig. 0
- 1178-7704** Fig. 00
- 1178-7901** Fig. 1
- 1178-7902** Fig. 2
- 1178-7903** Fig. 3

gebogen 1/2 Kreis
 curved 1/2 circle
 curvas 1/2 círculo
 curvi 1/2 circolo

in Packungen zu 12 Stück
 in packages of 12 pieces
 en paquetes de 12 piezas
 in confezione da 12 pezzi



1561-1002 150x95x13 mm



1561-1202 150x95x13 mm

perforierter Deckel und Boden
perforated lid and bottom
tapa y fondo perforado
coperchio e fondo perforati



1561-1203 150x95x13 mm

perforierter Boden
perforated bottom
fondo perforado
fondo perforato



1561-1205 150x95x13 mm



1561-1201 150x95x13 mm

perforierter Deckel und Boden
perforated lid and bottom
tapa y fondo perforado
coperchio e fondo perforati

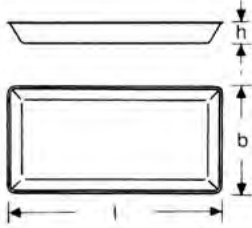

1561-1250 50x25x4,5 mm
1561-1265 65x42x8,0 mm
1561-1275 75x25x4,5 mm

1561-0250 50x25x4,5 mm
1561-0265 65x42x8,0 mm
1561-0275 75x25x4,5 mm

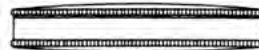

1561-0065 Ø 62x13 mm
Innendose allein, perforiert
Interior box, perforated
Caja interior, perforada
Scatola interiore, perforati

1561-0000 Ø 65x15 mm



KALT

1170-6614 14,0 cm / 5 1/2"



1170-5014

1170-5114

ARRUGA

1170-5014 - 1170-5114 14,0 cm / 5 1/2"



1170-5016

1170-5116

ARRUGA

1170-5016 - 1170-5116 16,0 cm / 6 1/4"

Maul 0,5 mm
 jaw 0,5 mm
 boca 0,5 mm
 muso 0,5 mm



1176-8910

1176-9010

ohne Sperre
 without ratchet
 sin cierre
 senza chiusura

Maul 0,5 mm
 jaw 0,5 mm
 boca 0,5 mm
 muso 0,5 mm



1176-9610

1176-9710

mit Sperre
 with ratchet
 con cierre
 con chiusura

BARRAQUER-TROUTMAN

1176-8910 - 1176-9010 10,0 cm / 4"

BARRAQUER-TROUTMAN

1176-9610 - 1176-9710 10,0 cm / 4"

Maul 1,0 mm
 jaw 1,0 mm
 boca 1,0 mm
 muso 1,0 mm

glatt
 smooth
 liso
 liscio



1176-6211

1176-6213

1176-7414

1176-6311

1176-6313

1176-7514

ohne Sperre
 without ratchet
 sin cierre
 senza chiusura

Maul 1,0 mm
 jaw 1,0 mm
 boca 1,0 mm
 muso 1,0 mm

glatt
 smooth
 liso
 liscio

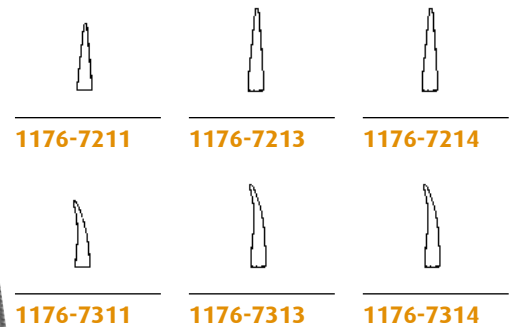

1176-7211

1176-7213

1176-7214

1176-7311

1176-7313

1176-7314

mit Sperre
 with ratchet
 con cierre
 con chiusura

BARRAQUER

1176-6211 - 1176-6311 11,5 cm / 4 1/2"
 1176-6213 - 1176-6313 13,0 cm / 5 1/8"
 1176-7414 - 1176-7514 14,0 cm / 5 1/2"

BARRAQUER

1176-7211 - 1176-7311 11,5 cm / 4 1/2"
 1176-7213 - 1176-7313 13,0 cm / 5 1/8"
 1176-7214 - 1176-7314 14,0 cm / 5 1/2"

Maul 1,0 mm
 jaw 1,0 mm
 boca 1,0 mm
 muso 1,0 mm



glatt
 smooth
 liso
 liscio

mit Sperre
 with ratchet
 con cierre
 con chiusura

Maul 1,0 mm
 jaw 1,0 mm
 boca 1,0 mm
 muso 1,0 mm



glatt
 smooth
 liso
 liscio

mit Sperre
 with ratchet
 con cierre
 con chiusura

BARRAQUER

1176-7615 15,0 cm / 6"
1176-7618 18,0 cm / 7"
1176-7621 21,0 cm / 8¹/₄"

BARRAQUER

1176-7315 15,0 cm / 6"
1176-7318 18,0 cm / 7"
1176-7321 21,0 cm / 8¹/₄"

Maul 1,0 mm
 jaw 1,0 mm
 boca 1,0 mm
 muso 1,0 mm

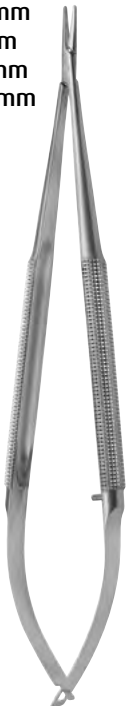

glatt
 smooth
 liso
 liscio

ohne Sperre
 without ratchet
 sin cierre
 senza chiusura

Maul 1,0 mm
 jaw 1,0 mm
 boca 1,0 mm
 muso 1,0 mm



glatt
 smooth
 liso
 liscio

ohne Sperre
 without ratchet
 sin cierre
 senza chiusura



gebogen
 curved
 curva
 curva

ohne Sperre
 without ratchet
 sin cierre
 senza chiusura

BARRAQUER

1176-7415 15,0 cm / 6"
1176-7418 18,0 cm / 7"
1176-7421 21,0 cm / 8¹/₄"

BARRAQUER

1176-7515 15,0 cm / 6"
1176-7518 18,0 cm / 7"
1176-7521 21,0 cm / 8¹/₄"

GOMEL

1176-7714 14,0 cm / 5¹/₂"

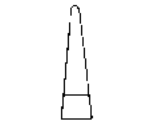

1176-0816

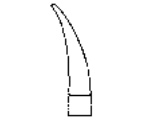

1176-0916

mit Sperre
with ratchet
con cierre
con chiusura

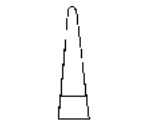

1176-1016

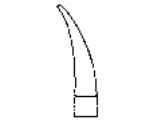

1176-1116

ohne Sperre
without ratchet
sin cierre
senza chiusura

CASTROVIEJO

1176-0816 - 1176-0916

14,0 cm / 5 1/2"

CASTROVIEJO

1176-1016 - 1176-1116

14,0 cm / 5 1/2"



1176-0814



1176-0914

mit Sperre
with ratchet
con cierre
con chiusura



1176-1014



1176-1114

ohne Sperre
without ratchet
sin cierre
senza chiusura

CASTROVIEJO

1176-0814 - 1176-0914

14,0 cm / 5 1/2"

CASTROVIEJO

1176-1014 - 1176-1114

14,0 cm / 5 1/2"



mit Sperre
with ratchet
con cierre
con chiusura

CASTROVIEJO (JACOBSON)

1176-2018 18,0 cm / 7"
1176-2021 21,0 cm / 8¹/₄"



mit Sperre
with ratchet
con cierre
con chiusura

CASTROVIEJO (JACOBSON)

1176-2118 18,0 cm / 7"
1176-2121 21,0 cm / 8¹/₄"



mit Sperre
with ratchet
con cierre
con chiusura

CASTROVIEJO (JACOBSON)

1176-2218 18,0 cm / 7"
1176-2221 21,0 cm / 8¹/₄"



mit Sperre
with ratchet
con cierre
con chiusura

CASTROVIEJO (JACOBSON)

1176-2318 18,0 cm / 7"
1176-2321 21,0 cm / 8¹/₄"



ohne Sperre
without ratchet
sin cierre
senza chiusura

CASTROVIEJO (JACOBSON)

1176-2418 18,0 cm / 7"
1176-2421 21,0 cm / 8¹/₄"



ohne Sperre
without ratchet
sin cierre
senza chiusura

CASTROVIEJO (JACOBSON)

1176-2518 18,0 cm / 7"
1176-2521 21,0 cm / 8¹/₄"



ohne Sperre
without ratchet
sin cierre
senza chiusura

CASTROVIEJO (JACOBSON)

1176-2618 18,0 cm / 7"
1176-2621 21,0 cm / 8¹/₄"



ohne Sperre
without ratchet
sin cierre
senza chiusura

CASTROVIEJO (JACOBSON)

1176-2718 18,0 cm / 7"
1176-2721 21,0 cm / 8¹/₄"



glatt
 smooth
 liso
 liscio

ohne Sperre
 without ratchet
 sin cierre
 senza chiusura

YASARGIL

- 1176-4220** 20,0 cm / 8"
- 1176-4222** 22,5 cm / 9"
- 1176-4245** 24,5 cm / 9²/₃"



glatt
 smooth
 liso
 liscio

ohne Sperre
 without ratchet
 sin cierre
 senza chiusura

YASARGIL

- 1176-4320** 20,0 cm / 8"
- 1176-4322** 22,5 cm / 9"
- 1176-4345** 24,5 cm / 9²/₃"



glatt
 smooth
 liso
 liscio

CASTROVIEJO

- 1176-8014** 13,0 cm / 5¹/₈"



glatt
 smooth
 liso
 liscio

CASTROVIEJO

- 1176-8114** 13,0 cm / 5¹/₈"



DERF
1170-3212 13,0 cm / 5¹/₈"



DERF
1170-3412 12,5 cm / 5"



COLLIER
1170-3612 12,5 cm / 5"

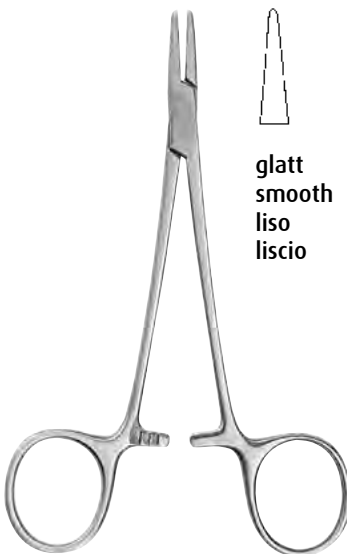

glatt
smooth
liso
liscio

WEBSTER
1170-2813 13,0 cm / 5"



gerieft
serrated
estriado
striato

WEBSTER
1170-2913 13,0 cm / 5"



glatt
smooth
liso
liscio

HALSEY
1170-3015 11,5 cm / 4"
1170-3013 13,0 cm / 5¹/₈"



HALSEY

1170-2613 13,0 cm / 5¹/₈"

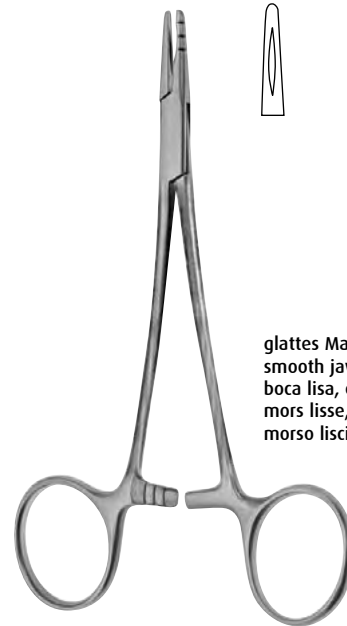

NEIVERT

1170-2413 13,0 cm / 5¹/₈"

glattes Maul mit Spezialkehlung
smooth jaw, special groove
boca lisa, especialmente acanalada
mors lisse, avec stries spéciales
morso liscio con scannellatura speciale



BAUMGARTNER

1170-2214 14,0 cm / 5¹/₂"



BROWN

1170-1813 13,0 cm / 5¹/₈"
1170-1818 18,0 cm / 7"



CRILE MURRAY
1170-1215 15,0 cm / 6"



CRILE WOOD
1170-1415 15,0 cm / 6"
1170-1418 18,0 cm / 7"
1170-1420 20,0 cm / 8"



ADSON
1170-0818 18,0 cm / 7"



METZENBAUM
1170-0618 18,0 cm / 7"



MASS.-GENERAL-HOSPITAL
1170-1017 17,0 cm / 6³/₄"



1170-0125



1170-0214



1170-0216



1170-0218



1170-0220



1170-0224



1170-0226



1170-0230

MAYO-HEGAR

1170-0125	12,5 cm / 5"
1170-0214	14,0 cm / 5 1/2"
1170-0216	16,0 cm / 6 1/4"
1170-0218	18,0 cm / 7"
1170-0220	20,0 cm / 8"
1170-0224	24,0 cm / 9 1/2"
1170-0226	26,0 cm / 10 1/4"
1170-0230	30,0 cm / 11 3/4"



1170-0416



1170-0418



1170-0420

schlankes Modell
delicate pattern
modelo delgado
modello gracile

MAYO HEGAR

1170-0416	16,0 cm / 6 1/4"
1170-0418	18,0 cm / 7"
1170-0420	20,0 cm / 8"



HEANEY

1170-3721 21,0 cm / 8¹/₄"

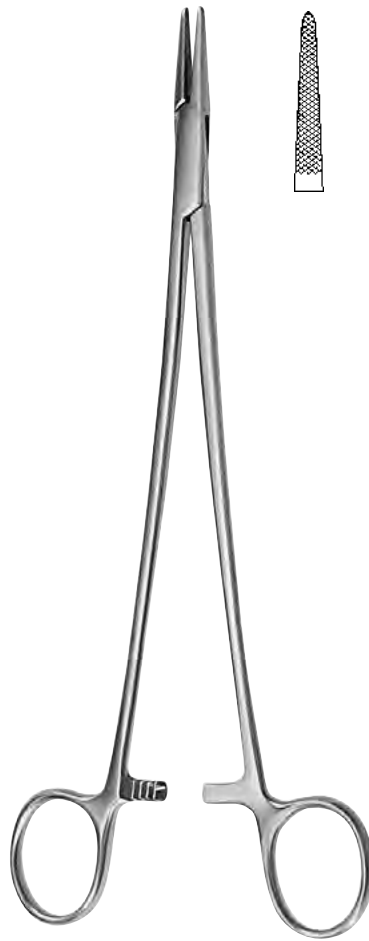

JAMISON

1170-4023 23,5 cm / 9¹/₄"



MASSON

1170-4227 27,0 cm / 10¹/₂"



FINOCHIETTO

1170-4527 27,0 cm / 10¹/₂"



WANGENSTEEN

1170-4427 27,0 cm / 10¹/₂"



JOHNSON

1170-4327 27,0 cm / 10¹/₂"

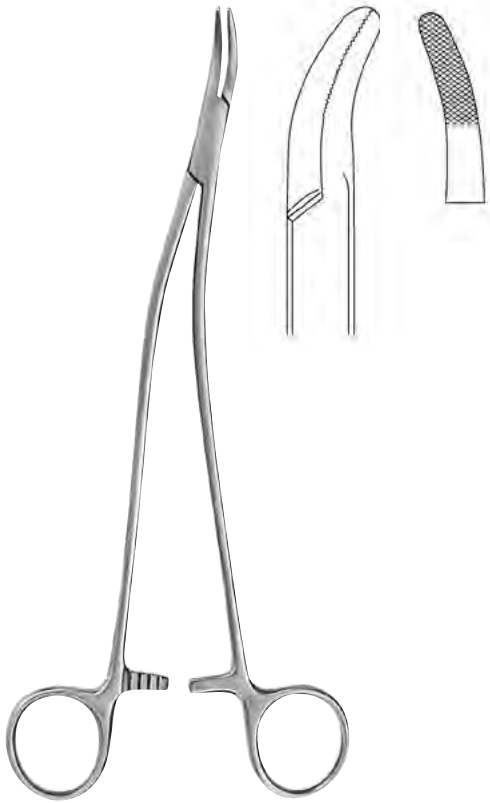

STRATTE

1170-3923 23,0 cm / 9"



MAYO-HEGAR

1170-0116 16,5 cm / 6 1/2"
1170-0118 19,0 cm / 7 1/2"



HEGAR

1170-0015 15,0 cm / 6"
1170-0018 17,5 cm / 7"
1170-0020 20,5 cm / 8"

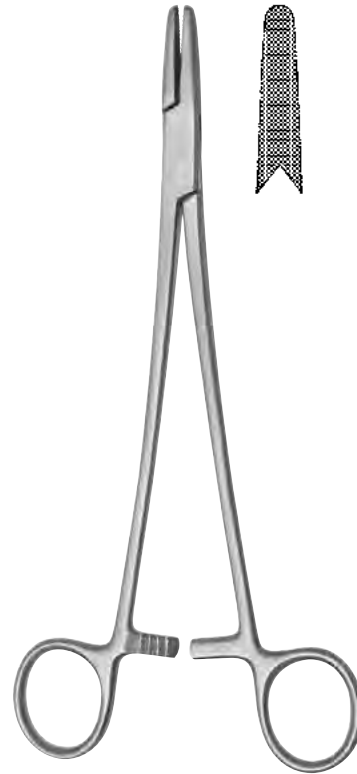

HEGAR

1170-0120 20,5 cm / 8"



OLSEN-HEGAR

1170-4612 11,5 cm / 4 1/2"
1170-4814 14,0 cm / 5 1/2"

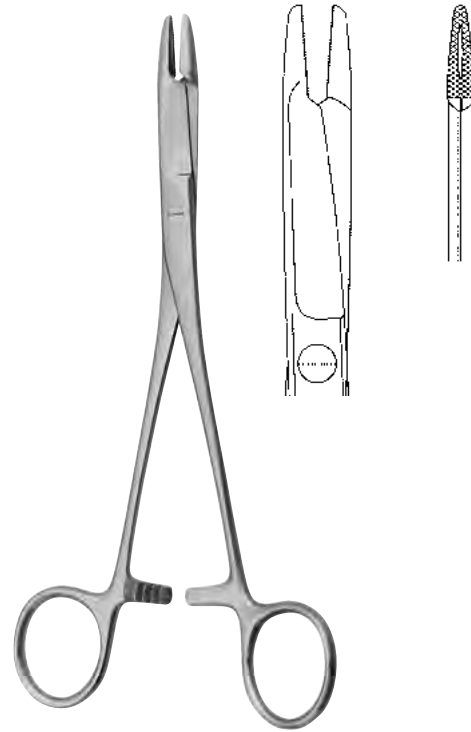

OLSEN-HEGAR

1170-4818 18,5 cm / 7 1/4"

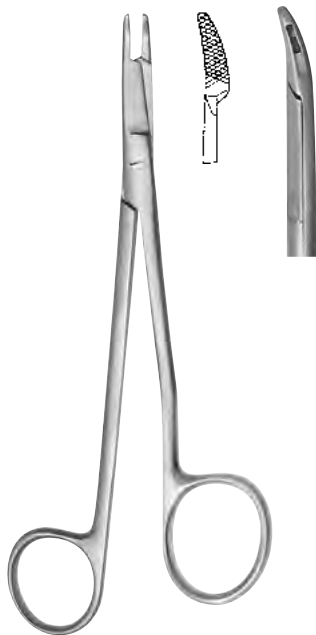

BABY-GILLIES

1170-4915 15,0 cm / 6"

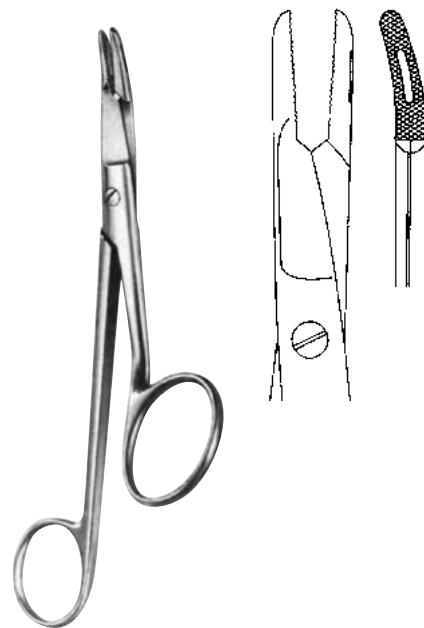

GILLIES

1170-4916 16,0 cm / 6 1/4"



1170-5214

1170-5217

1170-5220

MATHIEU

- 1170-5214 14,0 cm / 5¹/₂"
- 1170-5217 17,0 cm / 6³/₄"
- 1170-5220 20,0 cm / 8"

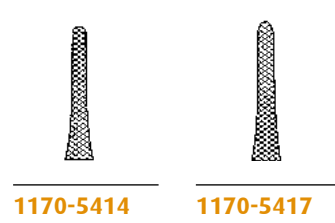

1170-5414

1170-5417

MATHIEU-KOCHER

- 1170-5414 14,0 cm / 5¹/₂"
- 1170-5417 17,0 cm / 6¹/₄"



MATHIEU-RYDER

- 1170-6914 14,0 cm / 5¹/₂"



TOENNIS

- 1170-7018 18,0 cm / 7"



LICHTENBERG

- 1170-5620 20,0 cm / 8"

Hartmetalleinlagen mit präzise gearbeitetem Pyramidenprofil garantieren einen sicheren Halt der Nadel.

Tungsten carbide inserts with precisely worked out structure guarantee to grip the needle securely.

Capas intermedias de carburo tungsteno con perfil amoldado piramidal que garantiza un sujeto seguro de la aguja.

Inserti in carburo di tungsteno che garantiscono una perfetta tenuta dell'ago.

Gebrochene Kanten verhindern ein Verfangen des Nahtmaterials.

Bevelled edges to prevent catching of suture material.

Bordes quebrados evitan que se enrede el material de sutura.

I bordi squadrati evitano che si impigliano i fili di sutura.

Vergoldete Ringe als leichte Kennzeichnung.

Gold-plated rings for easy identification.

Anillos dorados para fácil identificación

Anelli dorata permette una facile identificazione.

Leichtgängige Sperre ermöglicht eine sichere Arbeitsweise.

Soft working catch provides safe handling.

El cierre suave facilita un manejo seguro.

Il bloccaggio leggero e preciso facilita un uso sicuro.



Nadelhalter mit Hartmetalleinlagen
Needle Holders with tungsten carbide inserts
Porta-agujas con bocas de carburo tungsteno
Portaghi con morsi in carburo di tungsteno

019

Je nach Anwendungsgebiet stehen für TC Nadelhalter unterschiedliche Hartmetalleinlagen zur Verfügung:
According to the field of application, there are various types of tungsten carbide inserts for TC needle holders:
Según campo de aplicación, disponemos de TC porta-agujas con varias capas intermedias:
A seconda delle necessità disponiamo di TC portaghi con varie capacità intermedie:

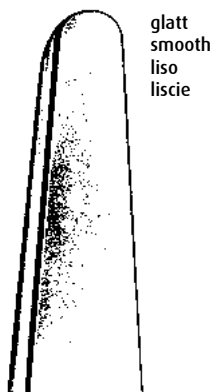

Zum Halten von extrem feinem Nahtmaterial.
For holding the smallest suture sizes.
Para sujetar suturas muy finas.
Per lavorare con suture sottilissime

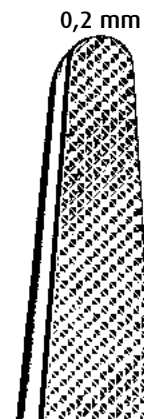

Zum Halten von Nahtmaterial der Stärken 7/0 bis 10/0.
For holding the suture sizes from 7/0 to 10/0.
Para sujetar suturas de gruesas 7/0 hasta 10/0.
Per lavorare con suture da 7/0 a 10/0.



Zum Halten von Nahtmaterial der Stärken 4/0 bis 6/0.
For holding the suture sizes from 4/0 to 6/0.
Para sujetar suturas de gruesas 4/0 hasta 6/0.
Per lavorare con suture da 4/0 a 6/0.

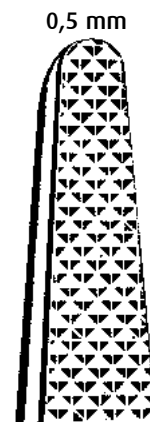

Zum Halten von Nahtmaterial der Stärke 3/0 und kräftiger.
For holding the suture size 3/0 and larger.
Para sujetar suturas de 3/0 y más gruesas.
Per lavorare con suture da 3/0 in poi.

**KALT**

1180-7103 14,0 cm / 5¹/₂"



1180-7616



1180-7716

ARRUGA

1180-7616 - 1180-7716

16,0 cm / 6¹/₄"

**BOYTON**

1180-6120 12,0 cm / 4³/₄"

Nadelhalter mit Hartmetalleinlagen
Needle Holders with tungsten carbide inserts
Porta-agujas con bocas de carburo tungsteno
Portaghi con morsi in carburo di tungsteno



ohne Sperre
without ratchet
sin cierre
senza chiusura

CASTROVIEJO (JACOBSON)

- 1180-1014** 14,0 cm / 5¹/₂"
- 1180-2418** 18,0 cm / 7"
- 1180-2622** 22,0 cm / 8³/₄"



ohne Sperre
without ratchet
sin cierre
senza chiusura

CASTROVIEJO (JACOBSON)

- 1180-1114** 14,0 cm / 5¹/₂"
- 1180-2518** 18,0 cm / 7"
- 1180-2522** 22,0 cm / 8³/₄"



ohne Sperre
without ratchet
sin cierre
senza chiusura

CASTROVIEJO (JACOBSON)

- 1180-2714** 14,0 cm / 5¹/₂"
- 1180-2718** 18,0 cm / 7"
- 1180-2720** 22,0 cm / 8³/₄"



ohne Sperre
without ratchet
sin cierre
senza chiusura

CASTROVIEJO (JACOBSON)

- 1180-2814** 14,0 cm / 5¹/₂"
- 1180-2818** 18,0 cm / 7"
- 1180-2820** 22,0 cm / 8³/₄"



mit Sperre
with ratchet
con cierre
con chiusura

CASTROVIEJO (JACOBSON)

- 1186-1214** 14,0 cm / 5¹/₂"
- 1186-1218** 18,0 cm / 7"
- 1186-1220** 22,0 cm / 8³/₄"



mit Sperre
with ratchet
con cierre
con chiusura

CASTROVIEJO (JACOBSON)

- 1186-1314** 14,0 cm / 5¹/₂"
- 1186-1318** 18,0 cm / 7"
- 1186-1322** 22,0 cm / 8³/₄"



CASTROVIEJO (JACOBSON)

- 1186-1014** 14,0 cm / 5¹/₂"
- 1186-1018** 18,0 cm / 7"
- 1186-1022** 22,0 cm / 8³/₄"



CASTROVIEJO (JACOBSON)

- 1186-1114** 14,0 cm / 5¹/₂"
- 1186-1118** 18,0 cm / 7"
- 1186-1122** 22,0 cm / 8³/₄"



1186-7818

1186-7918



BARRAQUER

- 1186-7418** 18,0 cm / 7"



BARRAQUER

- 1186-7514** 14,0 cm / 5¹/₂"
- 1186-7518** 18,0 cm / 7"

BARRAQUER

- 1186-7818 - 1186-7918** 18,0 cm / 7"

Nadelhalter mit Hartmetalleinlagen
Needle Holders with tungsten carbide inserts
Porta-agujas con bocas de carburo tungsteno
Portaghi con morsi in carburo di tungsteno

019



BARRAQUER

1186-7418 18,0 cm / 7"
 1186-7421 21,0 cm / 8¹/₄"



BARRAQUER

1186-7518 18,0 cm / 7"
 1186-7521 21,0 cm / 8¹/₄"



BARRAQUER

1186-6017 18,0 cm / 7"
 1186-6021 21,0 cm / 8¹/₄"



BARRAQUER

1186-7714 14,0 cm / 5¹/₂"
 1186-7718 18,0 cm / 7"
 1186-7721 21,0 cm / 8¹/₄"



diamantbeschichtet
 diamond coated
 capa de diamante
 strato di diamante

YASARGIL

1176-4222 22,5 cm / 9"



diamantbeschichtet
 diamond coated
 capa de diamante
 strato di diamante

ohne Sperre
 without ratchet
 sub cierre
 senza chiusura

YASARGIL

1176-5322 22,5 cm / 9"



DIETRICH

1180-9160	16,0 cm / 6 ¹ / ₄ "
1180-9180	18,0 cm / 7"
1180-9120	20,0 cm / 8"
1180-9123	23,0 cm / 9"
1180-9125	25,0 cm / 9 ³ / ₄ "



DIETRICH

1180-8160	16,0 cm / 6 ¹ / ₄ "
1180-8180	18,0 cm / 7"
1180-8120	20,0 cm / 8"
1180-8123	23,0 cm / 9"
1180-8125	25,0 cm / 9 ³ / ₄ "



HEPP-SCHEIDEL

1186-5818	18,0 cm / 7"
------------------	--------------

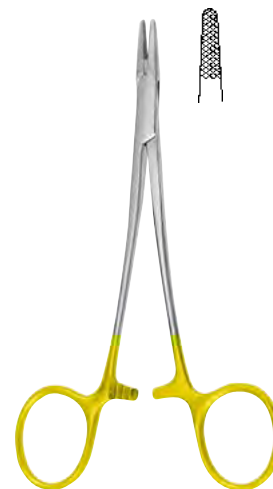

DERF

1180-3212	12,0 cm / 4 ³ / ₄ "
------------------	-------------------------------------------

Nadelhalter mit Hartmetalleinlagen
Needle Holders with tungsten carbide inserts
Porta-agujas con bocas de carburo tungsteno
Portaghi con morsi in carburo di tungsteno

019



CONVERSE

1180-3412 12,0 cm / 4³/₄"

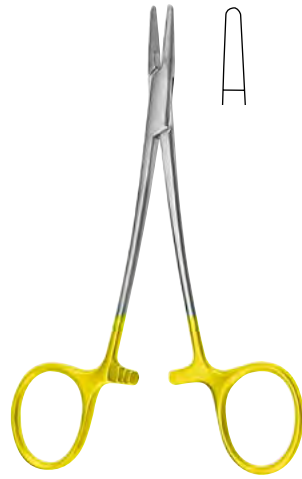

WEBSTER

1180-3115 11,5 cm / 4¹/₂"
1180-3013 13,0 cm / 5¹/₈"

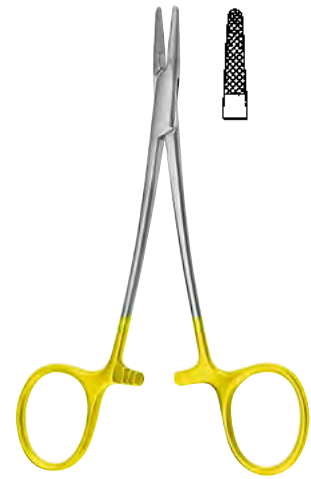

WEBSTER

1180-3213 13,0 cm / 5¹/₈"

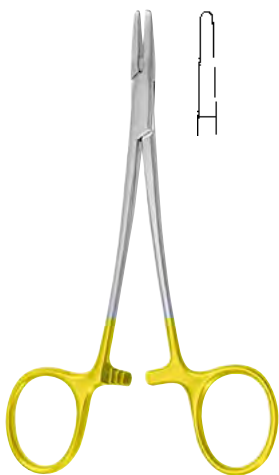

HALSEY

1180-2813 13,0 cm / 5¹/₈"



HALSEY

1180-2611 11,5 cm / 4¹/₂"
1180-2613 13,0 cm / 5¹/₈"



NEIVERT

1180-2413 13,0 cm / 5¹/₈"

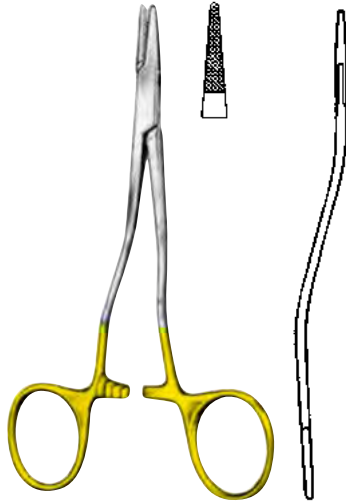

KILNER

1180-3113 13,5 cm / 5¹/₄"



BAUMGARTNER

1180-2213 12,5 cm / 5"
1180-2214 14,0 cm / 5¹/₂"



1180-0214



1180-0216



1180-0218



1180-0220



1180-0224



1180-0226



1180-0230



MAYO-HEGAR

1180-0214 14,0 cm / 5¹/₂"
1180-0216 16,0 cm / 6¹/₄"
1180-0218 18,0 cm / 7"
1180-0220 20,0 cm / 8"
1180-0224 24,0 cm / 9¹/₂"
1180-0226 26,0 cm / 10¹/₄"
1180-0230 30,0 cm / 11³/₄"

Nadelhalter mit Hartmetalleinlagen
Needle Holders with tungsten carbide inserts
Porta-agujas con bocas de carburo tungsteno
Portaghi con morsi in carburo di tungsteno

019

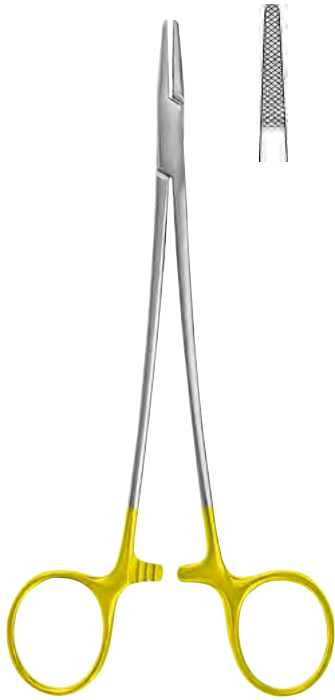

MAYO-HEGAR - SLENDER PATTERN

1180-0118 18,0 cm / 7"
1180-0120 20,0 cm / 8"

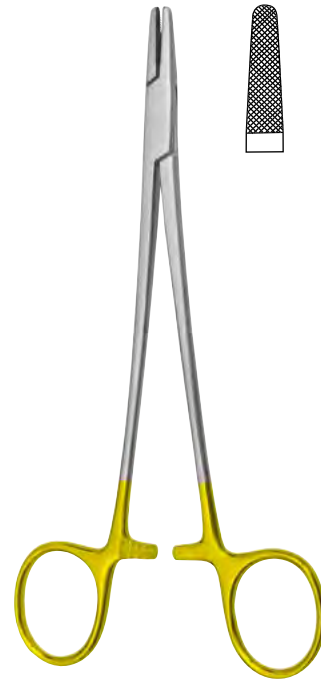

MAYO-HEGAR - HEAVY PATTERN

1180-0018 18,0 cm / 7"



HEGAR

1180-0020 20,0 cm / 8"
1180-0024 24,0 cm / 9⁵/₈"



MAYO-HEGAR (HEANEY)

1180-3720 20,0 cm / 8"
1180-3724 24,0 cm / 9⁵/₈"
1180-3726 26,0 cm / 10¹/₄"

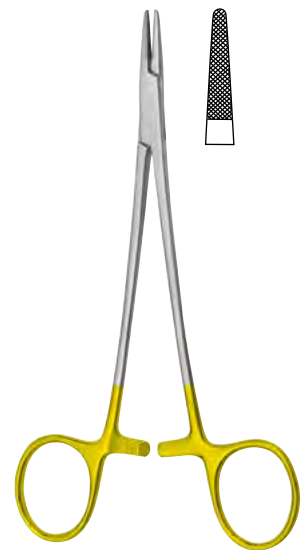

CRILE-WOOD BABY

1180-1415 15,0 cm / 6"



CRILE-WOOD

- 1180-1215 15,0 cm / 6"
- 1180-1218 18,0 cm / 7"
- 1180-1220 20,0 cm / 8"
- 1180-1223 23,0 cm / 9"
- 1180-1226 26,0 cm / 10¹/₄"

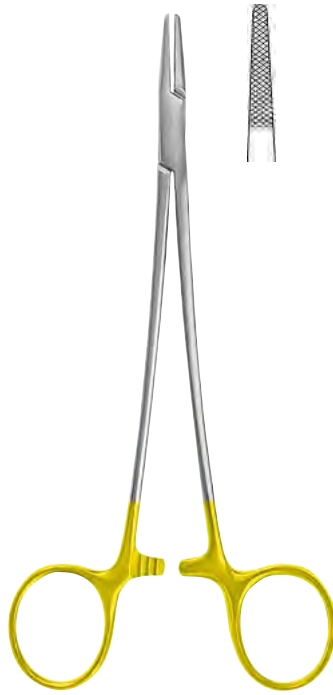

DEBAKEY

- 1180-0415 15,0 cm / 6"
- 1180-0416 16,5 cm / 6¹/₂"
- 1180-0418 18,0 cm / 7"
- 1180-0420 20,0 cm / 8"
- 1180-0423 23,0 cm / 9"
- 1180-0426 26,0 cm / 10¹/₄"
- 1180-0431 31,0 cm / 12¹/₄"

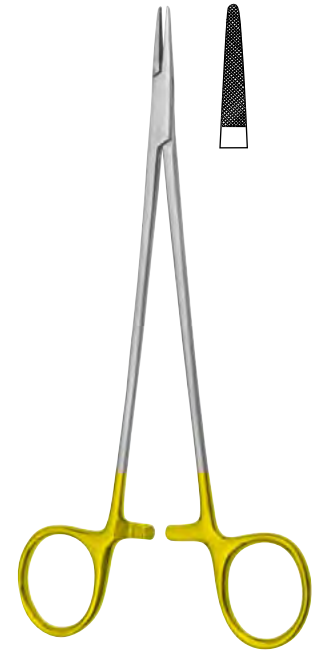

MIKRO-SLIM

- 1181-0614 15,0 cm / 6"
- 1181-0618 18,0 cm / 7"
- 1181-0620 20,0 cm / 8"
- 1181-0623 23,0 cm / 9"

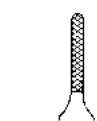
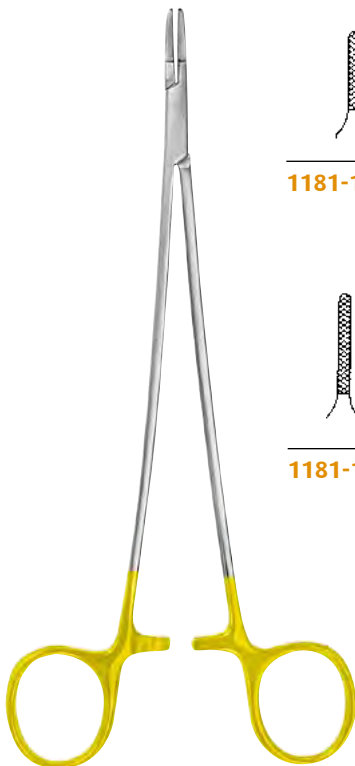

1181-1013

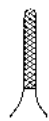

019-590-150



1181-1018



1181-1020



1181-1023



1181-1026

RYDER-FRENCH EYE

- 1181-1013 13,0 cm / 5¹/₈"
- 1181-1015 15,0 cm / 6"
- 1181-1018 18,0 cm / 7"
- 1181-1020 20,0 cm / 8"
- 1181-1023 23,0 cm / 9"
- 1181-1026 26,0 cm / 10¹/₄"

Nadelhalter mit Hartmetalleinlagen
Needle Holders with tungsten carbide inserts
Porta-agujas con bocas de carburo tungsteno
Portaghi con morsi in carburo di tungsteno

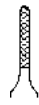
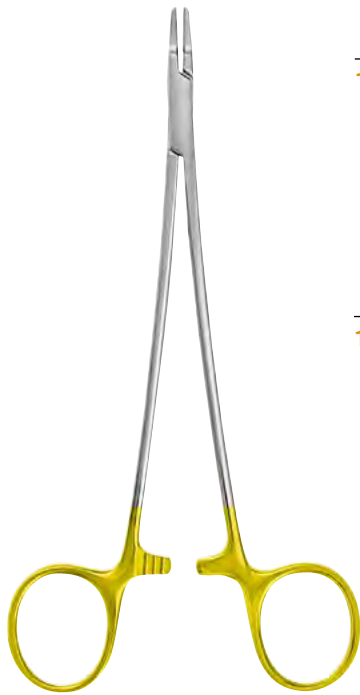

1181-1213



1181-1215



1181-1218



1181-1220

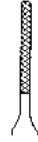

1181-1223



1181-1226

RYDER-MINI

1181-1213	13,0 cm / 5 ¹ / ₈ "
1181-1215	15,0 cm / 6"
1181-1218	18,0 cm / 7"
1181-1220	20,0 cm / 8"
1181-1223	23,0 cm / 9"
1181-1226	26,0 cm / 10 ¹ / ₄ "

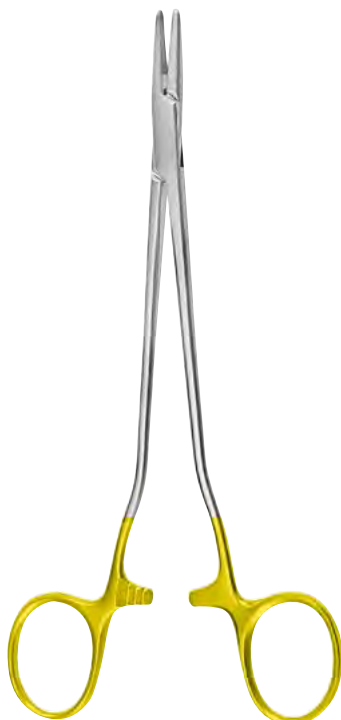

1181-0014



1181-0018



1181-0020



1181-0023

HEGAR-VASCULAR

1181-0014	14,0 cm / 5 ¹ / ₂ "
1181-0018	18,0 cm / 7"
1181-0020	20,0 cm / 8"
1181-0023	23,0 cm / 9"

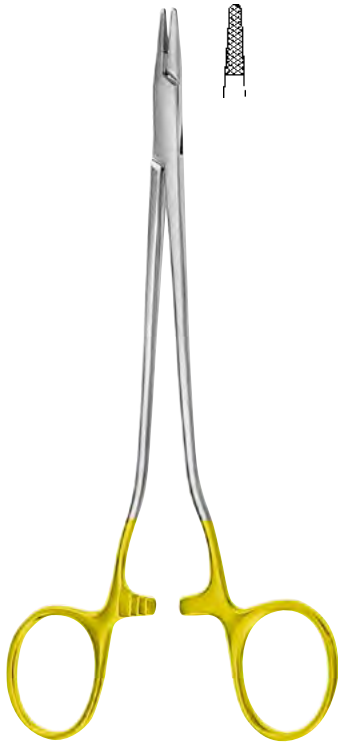

SENNING

- 1180-1615** 15,0 cm / 6"
- 1180-1617** 17,0 cm / 6³/₄"
- 1180-1620** 20,0 cm / 8"

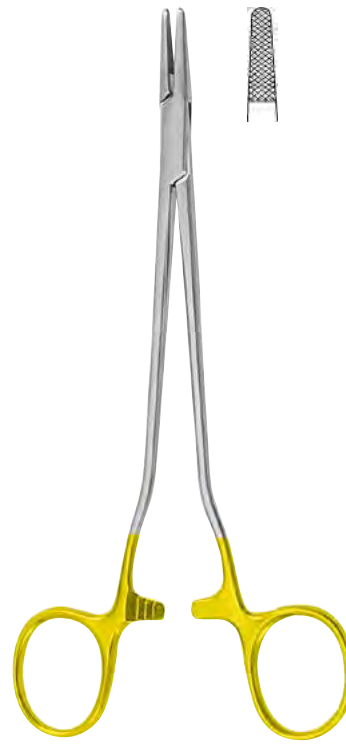

SAROT

- 1180-2018** 18,0 cm / 7"
- 1180-2020** 20,0 cm / 8"
- 1180-2023** 23,0 cm / 9"
- 1180-2026** 26,0 cm / 10¹/₄"

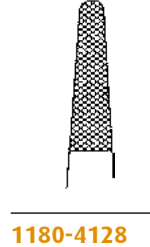
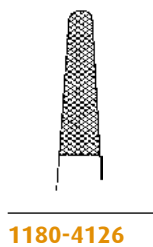
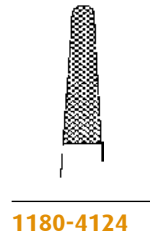
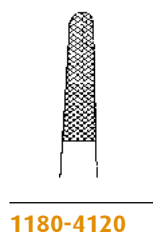
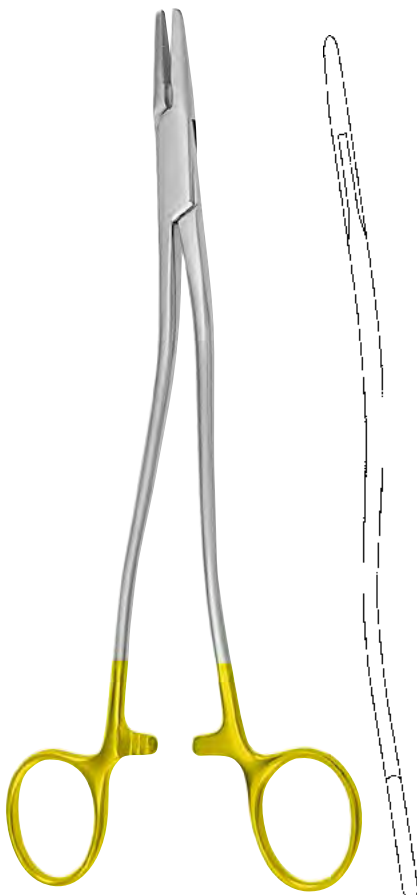

BOZEMANN

- 1180-4120** 20,0 cm / 8"
- 1180-4124** 24,0 cm / 9¹/₂"
- 1180-4126** 26,0 cm / 10¹/₄"
- 1180-4128** 30,0 cm / 11³/₄"

Nadelhalter mit Hartmetalleinlagen
Needle Holders with tungsten carbide inserts
Porta-agujas con bocas de carburo tungsteno
Portaghi con morsi in carburo di tungsteno

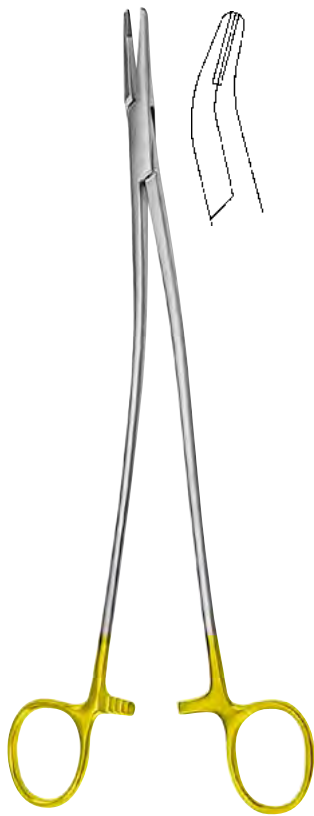

1180-3622

1180-3923

STRATTE

1180-3622 21,0 cm / 8¹/₄"
 1180-3923 23,0 cm / 9"



MASSON

1180-4227 27,0 cm / 10¹/₄"



FINOCHIETTO

1180-4527 27,0 cm / 10¹/₄"

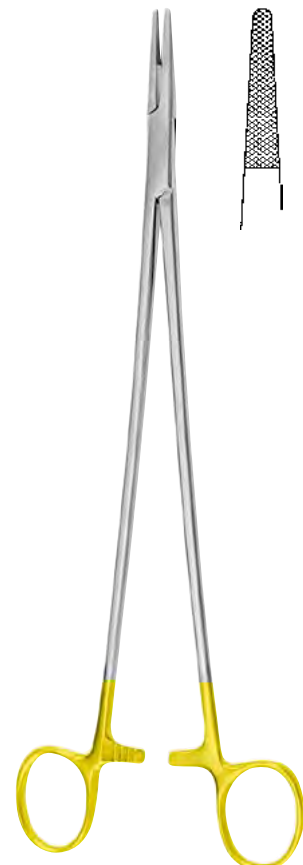

WANGENSTEEN

1180-4427 28,0 cm / 11"

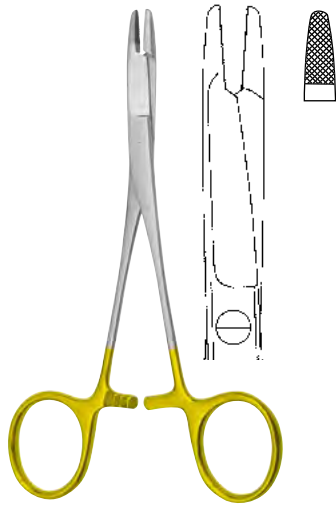

OLSEN-HEGAR

1180-4613	11,5 cm / 4 ¹ / ₂ "
1180-4814	14,0 cm / 5 ¹ / ₂ "
1180-4816	17,0 cm / 6 ³ / ₄ "
1180-4818	18,5 cm / 7 ¹ / ₄ "

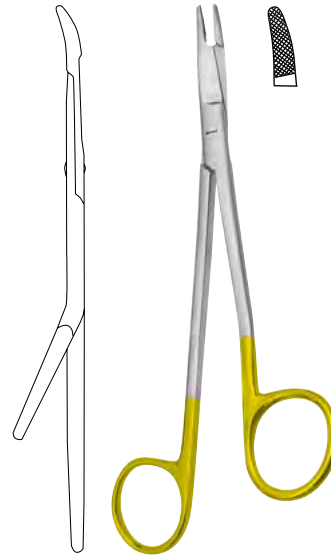

BABY-GILLIES

1180-5115	15,0 cm / 6"
------------------	--------------

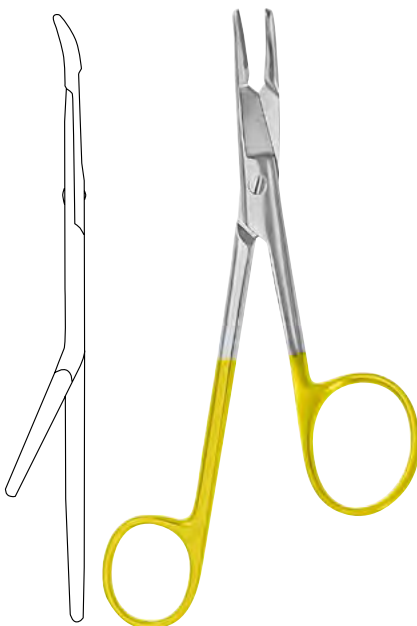

GILLIES

1180-5116	16,0 cm / 6 ¹ / ₄ "
------------------	-------------------------------------------

Nadelhalter mit Hartmetalleinlagen
Needle Holders with tungsten carbide inserts
Porta-agujas con bocas de carburo tungsteno
Portaghi con morsi in carburo di tungsteno



1180-5314



1180-5317



1180-5320



1180-5344

MATHIEU

1180-5314	14,0 cm / 5 ¹ / ₂ "
1180-5317	17,0 cm / 6 ³ / ₄ "
1180-5320	20,0 cm / 8"
1180-5344	24,0 cm / 6 ¹ / ₂ "



1180-5414



1180-5417



1180-5420

MATHIEU-KOCHER

1180-5414	14,0 cm / 5 ¹ / ₂ "
1180-5417	17,0 cm / 6 ³ / ₄ "
1180-5420	20,0 cm / 8"



1181-2014



1181-2017



1181-2020



1180-5214



1180-5217



1180-5321

MATHIEU-RYDER

1181-2014	14,0 cm / 5 ¹ / ₂ "
1181-2017	17,0 cm / 6 ³ / ₄ "
1181-2020	20,0 cm / 8"

MATHIEU

1180-5214	14,0 cm / 5 ¹ / ₂ "
1180-5217	17,0 cm / 6 ³ / ₄ "
1180-5321	20,0 cm / 8"



1180-7216



1180-7218



1180-7220

LANGENBECK

1180-7216	16,0 cm / 6 ¹ / ₄ "
1180-7218	18,0 cm / 7"
1180-7220	20,0 cm / 8"

Nadelhalter mit Hartmetalleinlagen
Needle Holders with tungsten carbide inserts
Porta-agujas con bocas de carburo tungsteno
Portaghi con morsi in carburo di tungsteno

019



CRILE

1180-6115 15,0 cm / 6"



TOENNIS

1180-7018 18,0 cm / 7"



LICHTENBERG

1180-5617 17,0 cm / 6³/₄"
1180-5620 20,0 cm / 8"



LICHTENBERG

1180-5717 17,0 cm / 6³/₄"



mit langem Hals
with long neck
con cuello largo
con collo lungo

HÖSEL

1180-5820 20,0 cm / 8"



1180-6620



1180-6623



ZWEIFEL

1180-6620 20,0 cm / 8"
 1180-6623 23,0 cm / 9"



mit langem Hals
 with long neck
 con cuello largo
 con collo lungo

HÖSEL

1180-5826 26,0 cm / 10³/₄"

**Unterbindungsnadeln
Ligature Needles
Agujas para ligaduras
Aghi per legatura**

019

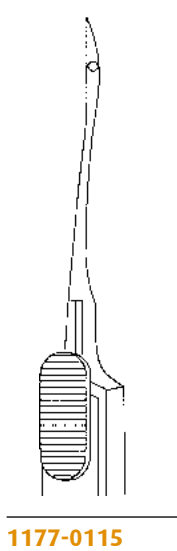

1177-0115

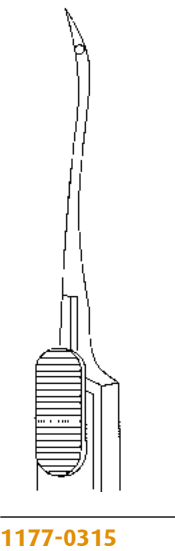

1177-0315

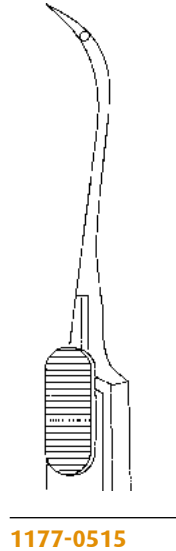

1177-0515

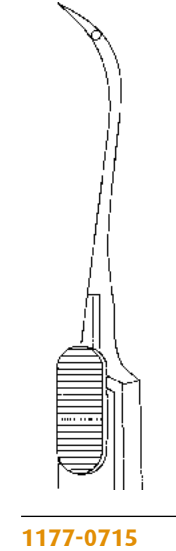

1177-0715

REVERDIN

1177-0115 - 1177-0715

14,0 cm / 5 1/2"

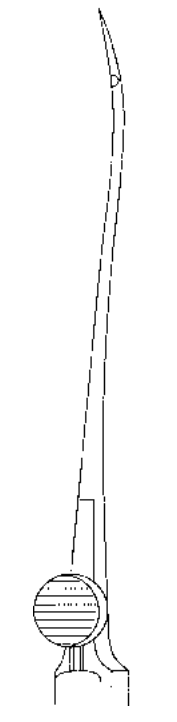

**1177-0119
1177-0123**

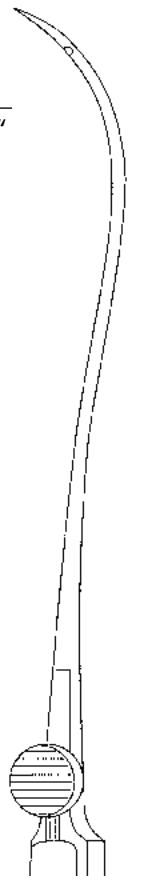

**1177-0319
1177-0323**

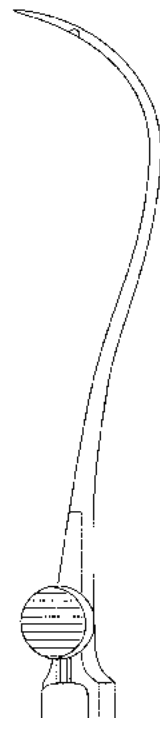

**1177-0519
1177-0523**

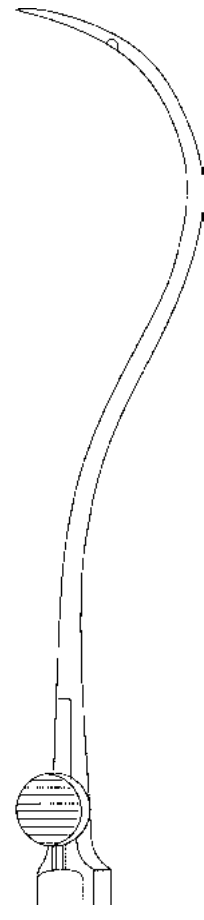

**1177-0719
1177-0723**

REVERDIN

**1177-0119 - 1177-0719
1177-0123 - 1177-0723**

**19,0 cm / 7 1/2"
23,0 cm / 9"**



Fig. 1
1177-9051

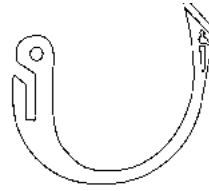

Fig. 2
1177-9052

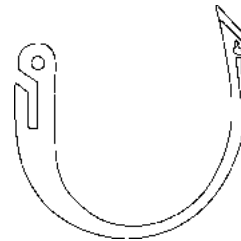

Fig. 3
1177-9053

komplett mit Nadel Fig.1
complete with needle Fig.1
completo con aguja Fig.1
completo con ago Fig.1

YOUNG

1177-9024 24,0 cm / 9 1/2"



SCHMIEDEN
1177-1321 24,0 cm / 9 1/2"

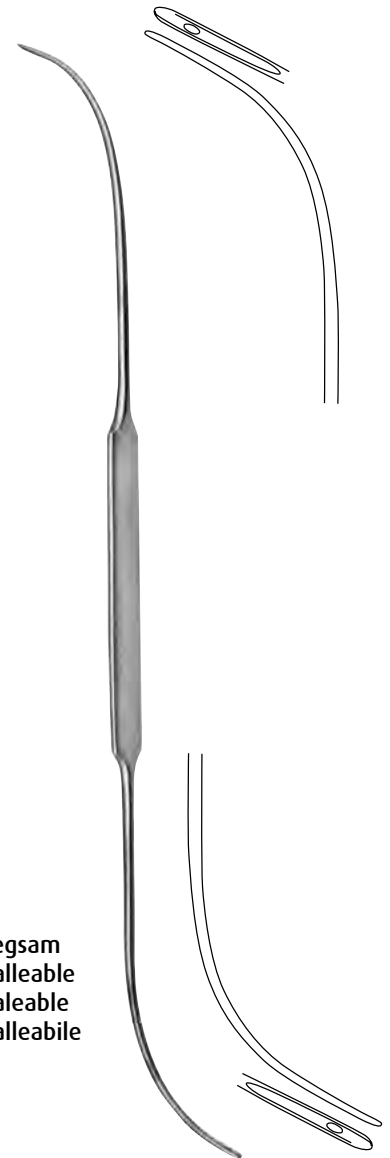

biegsam
malleable
maleable
malleabile

SCHMIEDEN-DICK
1177-1132 30,0 cm / 11 3/4"

**Unterbindungsnadeln
Ligature Needles
Agujas para ligaduras
Aghi per legatura**

019



1177-1520 20,0 cm / 8"

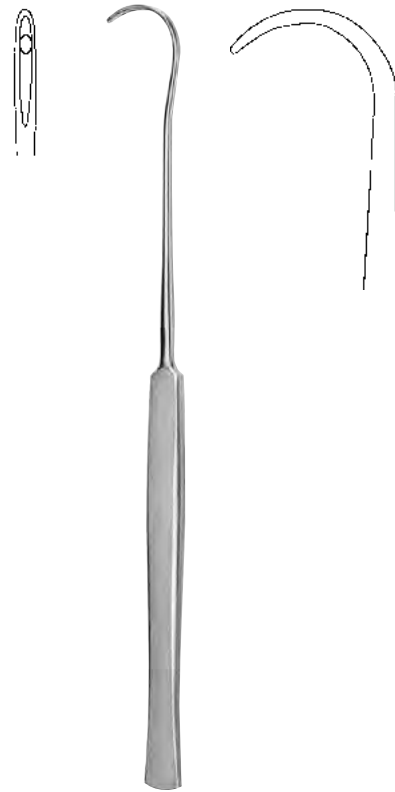

COOPER
1177-1719 19,0 cm / 7 1/2"



fein
für die rechte Hand
delicate
for right hand
fina
para la mano derecha
fino
per la mano destra

KRONECKER
1177-2113 13,0 cm / 5 1/8"

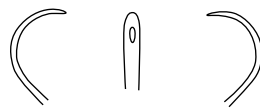

fein
für die linke Hand
delicate
for left hand
fina
para la mano izquierda
fino
per la mano sinistra

KRONECKER
1177-2313 13,0 cm / 5 1/8"

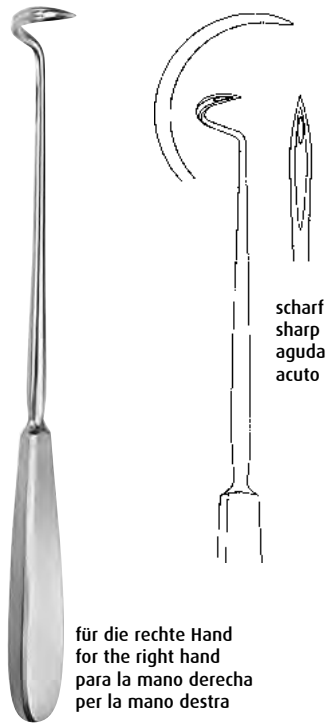

für die rechte Hand
for the right hand
para la mano derecha
per la mano destra

DESCHAMPS

1177-2520 20,0 cm / 8"

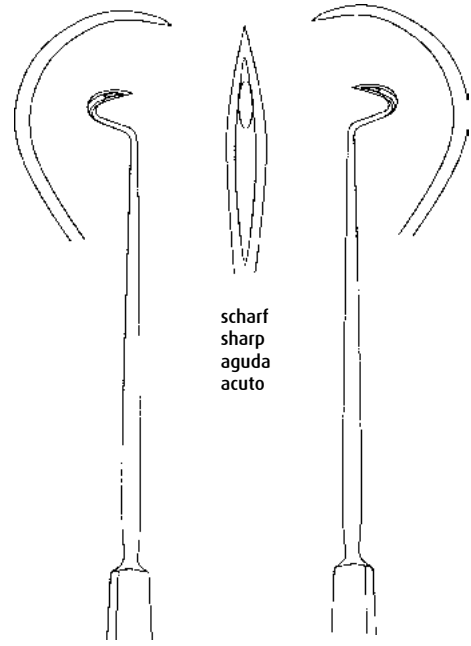

1177-3521
1177-3527

für die rechte Hand
for the right hand
para la mano derecha
per la mano destra

1177-3721
1177-3727

für die linke Hand
for the left hand
para la mano izquierda
per la mano sinistra

DESCHAMPS

1177-3521 - 1177-3721 21,0 cm / 8 1/4"
1177-3527 - 1177-3727 27,0 cm / 10 1/4"

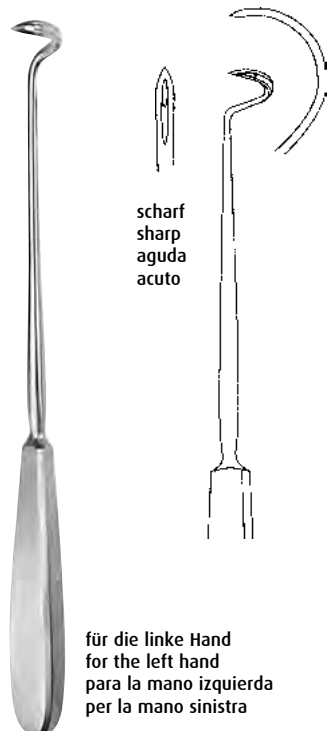

für die linke Hand
for the left hand
para la mano izquierda
per la mano sinistra

DESCHAMPS

1177-2620 20,0 cm / 8"

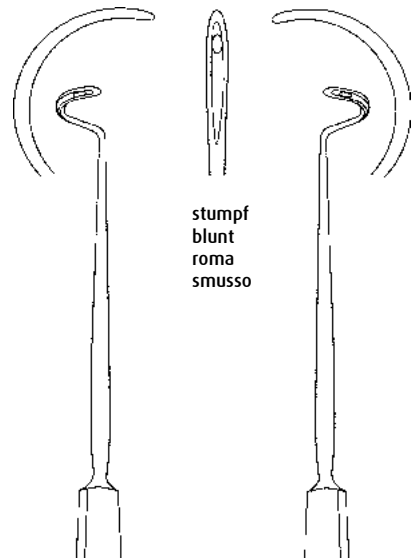

1177-3120

für die rechte Hand
for the right hand
para la mano derecha
per la mano destra

1177-3320

für die linke Hand
for the left hand
para la mano izquierda
per la mano sinistra

DESCHAMPS

20,0 cm / 8"

**Unterbindungsadeln
Ligature Needles
Agujas para ligaduras
Aghi per legatura**

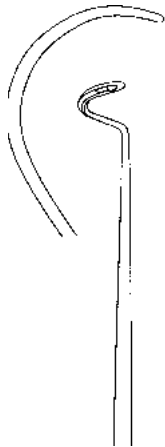

stumpf
blunt
roma
smusso

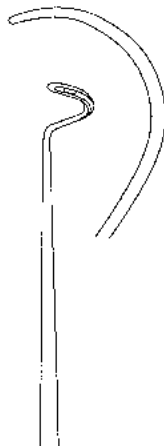

**1177-3121
1177-3124**

für die rechte Hand
for the right hand
para la mano derecha
per la mano destra

**1177-3321
1177-3324**

für die linke Hand
for the left hand
para la mano izquierda
per la mano sinistra

DESCHAMPS

**1177-3121 - 1177-3321
1177-3124 - 1177-3324**

21,0 cm / 8¹/₄"
24,0 cm / 9¹/₂"

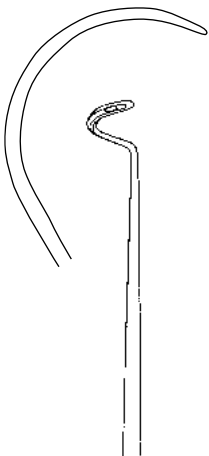

stumpf
blunt
roma
smusso

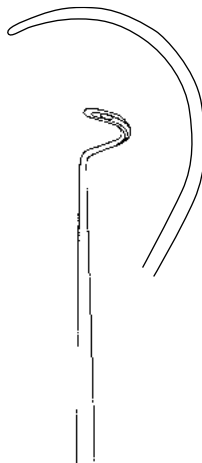

**1177-3227
1177-3228**

für die rechte Hand
for the right hand
para la mano derecha
per la mano destra

**1177-3327
1177-3328**

für die linke Hand
for the left hand
para la mano izquierda
per la mano sinistra

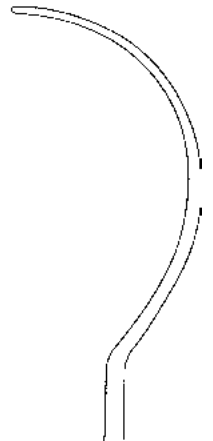

1177-4130

1177-4330

DESCHAMPS

**1177-3227 - 1177-3327
1177-3228 - 1177-3328**

24,0 cm / 9¹/₂"
28,0 cm / 11"

BRUNNER

1177-4130 - 1177-4330

30,0 cm / 11³/₄"



1177-4530

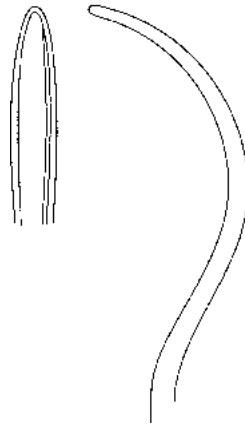

1177-4730

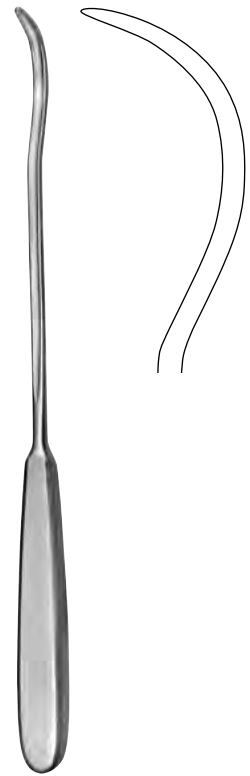

BRUNNER

1177-4530 - 1177-4730

30,0 cm / 11³/₄"

KIRSCHNER

1177-5125

25,5 cm / 10"

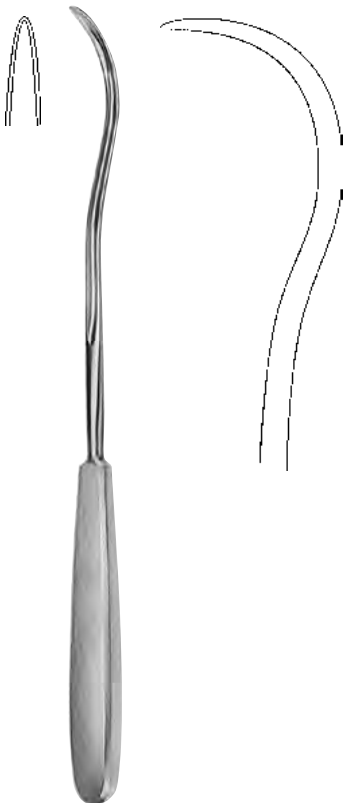

KIRSCHNER

1177-5128

28,0 cm / 11"

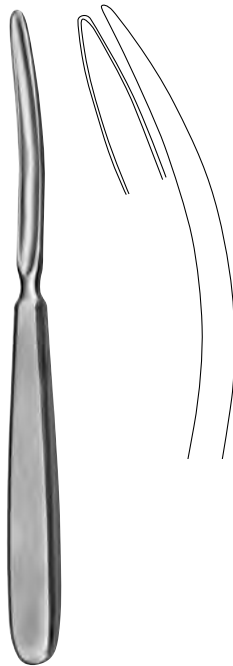

FRIMED

1177-5195

19,5 cm / 7³/₄"

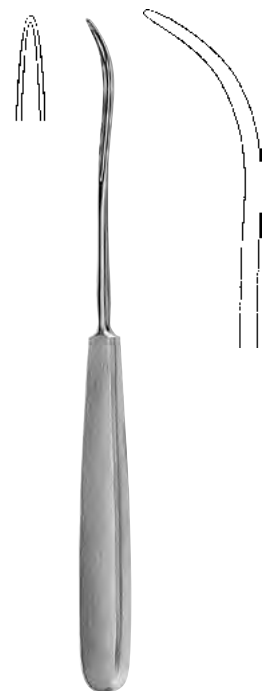

KÖNIG

1177-6019

19,5 cm / 7³/₄"

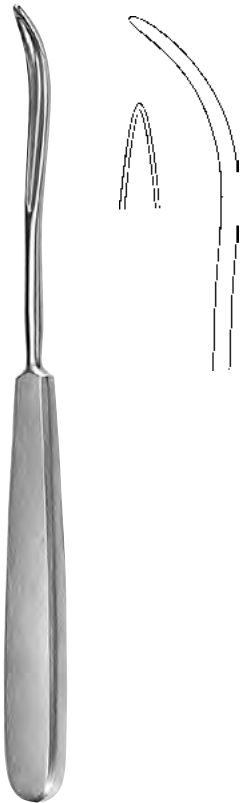

KÖNIG

1177-7119 19,5 cm / 7³/₄"



KÖNIG

1177-7219 19,5 cm / 7³/₄"

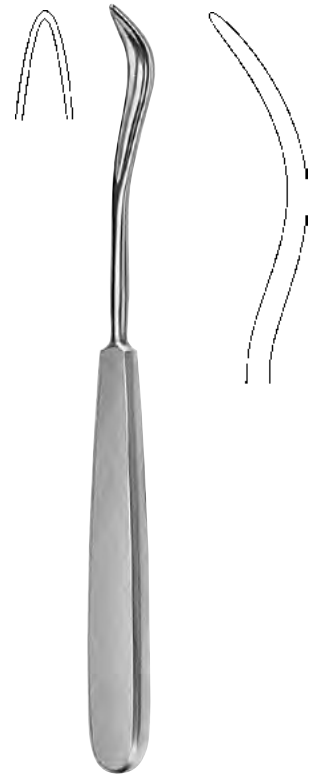

SCHMIEDEN

1177-6119 19,0 cm / 7¹/₂"

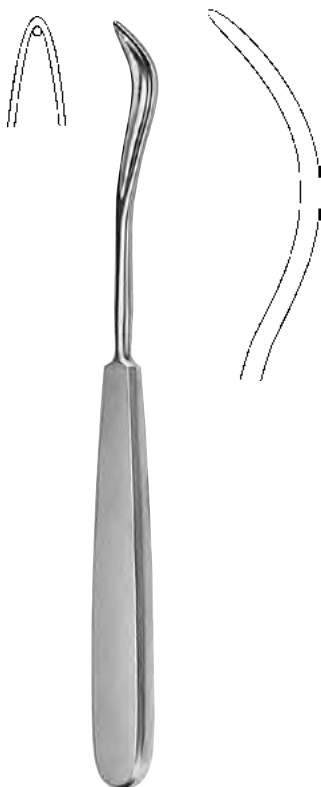

SCHMIEDEN-PAYR

1177-6319 19,0 cm / 7¹/₂"



PAYR

1177-7022 22,0 cm / 8⁵/₈"

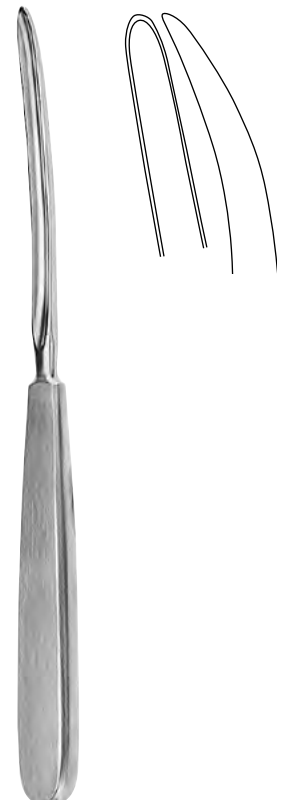

PAYR

1177-7123 22,0 cm / 8⁵/₈"



MOD. WIEN

1177-8724 23,5 cm / 9¹/₄"



BOZEMANN

1177-8821 21,0 cm / 8¹/₄"



FRIMED

1177-5123 23,0 cm / 9"



BRUNNER

1177-5518 18,0 cm / 7"
1177-5527 27,0 cm / 10³/₄"



KIRSCHNER

1177-5727 27,0 cm / 10³/₄"



FERROZELL

1177-5819 19,0 cm / 7¹/₂"

Führungshohlsonden, Wundklammerpinzetten
Ligature Conductors, Clip Applying Forceps
Sondas conductoras, Pinzas aplicadoras para agrafes
Sonde conduttrici, Pinze per applicare le agrafe

019



FERROZELL

1177-3318 18,5 cm / 7¹/₄"



FERROZELL

1177-2224 24,0 cm / 9¹/₂"



kräftig, mit Klammerschiene
heavy pattern, with clip holder
modelo fuerte, con porta-agrafe
modello forte, con porta-agrafe

CHILDE

1179-1802 18,0 cm / 7"



MICHEL

1179-1012 12,0 cm / 4³/₄"

zum Anlegen und Abnehmen der Klammern
 for applying and removal of clips
 para aplicar y quitar agrafes
 per applicare e togliere le agrafe



HEGENBARTH

1179-1612 12,0 cm / 4³/₄"



WACHENFELDT

1179-0125 12,5 cm / 5"



MICHEL

1179-0712 12,0 cm / 4³/₄"



langes Maul
 long jaw
 boca larga
 morso lungo

MOD. MICHEL

1179-0913 12,0 cm / 4³/₄"

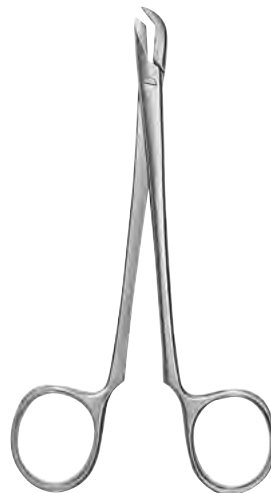

COLLIN

1179-3213 13,0 cm / 5"

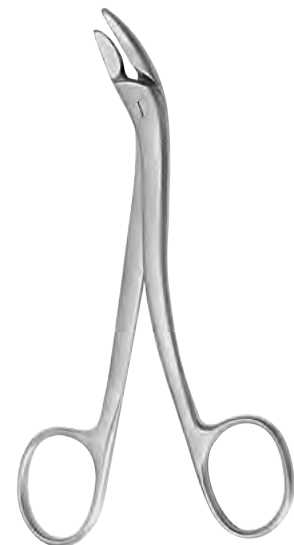

RICHTER-HEATH

1179-3314 14,0 cm / 5¹/₂"

Wundklammern, Wundklammernbesteck
Suture Clips, Suture Clip Set
Agrafes de sutura, Estuche para suturas
Agrafe, Set per sutura

019



MICHEL

1179-0207 7,5 x 1,75 mm



MICHEL

1179-0211 11,0 x 2,0 mm



MICHEL

1179-0212 12,0 x 3,0 mm

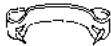

MICHEL

1179-0214 14,0 x 3,0 mm

Verkaufseinheit: 1000 Stück
(10 Packungen mit je 100 Stück)

Sales Unit: 1000 pieces
(10 packages with 100 each)

Unidad de venta: 1000 piezas
(10 paquetes con 100 piezas)

Unità di vendita: 1000 pezzi
(10 pacchetti con 100 pezzi)



MICHEL

1179-0216 16,0 x 3,0 mm



MICHEL

1179-0218 18,0 x 3,0 mm

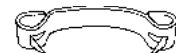

MICHEL

1179-0220 20,0 x 3,0 mm

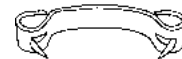

MICHEL

1179-0222 22,0 x 3,0 mm



SET

1179-0000 130x45x18 mm

Wundklammer-Besteck, komplett, im Metalltui,
bestehend aus:

- 1 Michel Wundklammerzängchen
- 1 Wachenfeldt Wundrand-Faßpinzette,
mit Klammerhalter
- 50 Michel Wundklammern, 14 x 3 mm
- 1 Plastikschiutzasche

Suture Clip Set, complete, in metal case,
consisting of:

- 1 Michel suture clip forceps
- 1 Wachenfeldt approximation forceps,
with clip holder
- 50 Michel suture clips, 14 x 3 mm
- 1 protection pouch, plastic

Estuche de agrafes, completo, en caja metálica,
compuesto de:

- 1 Michel pinza para agrafes
- 1 Wachenfeldt pinza aproximadora
con porta-agrafes
- 50 Michel agrafes, 14 x 3 mm
- 1 bolsa de proteccion, plástico

Set per sutura cutanea, completo, in contenitore
metallico

- composto di:
- 1 pinza per agrafes Michel
 - 1 pinza Wachenfeldt per avvicinare i
margini della ferrita, con port'agrafes
 - 50 agrafes Michel, 14 x 3 mm
 - 1 busta protettiva in plastica

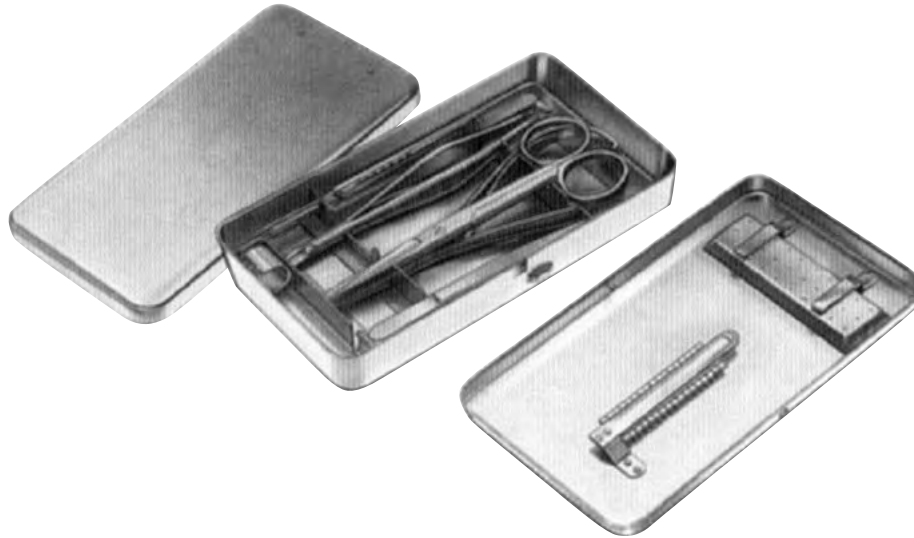

CLIP SET MINI ASSISTENT

1179-0010

Taschenbesteck "Mini-Assistent" komplett, in Metalletui bestehend aus:

- 1 Mathieu Nadelhalter, 14 cm
- 1 Packung mit Nähseide, steril
- 3 Stück Nähnadeln, verschiedene Größen
- 1 Nadeldose 50 x 25 mm, gelocht
- 1 Michel Wundklammerzängchen
- 20 Michel Wundklammern 14 x 3 mm, auf Halter
- 1 Skalpelli Griff, No. 4
- 3 Skalpellklingen, verschiedene Größen
- 1 Chirurgische Schere, gerade spitz/stumpf, 13 cm
- 1 Anatomische Pinzette, fein, 12,5 cm
- 1 Plastikschiuttasche

Pocket Set "Mini-Assistent", complete, in metal case consisting of:

- 1 Mathieu needle holder, 14 cm
- 1 package of silk, sterile
- 3 surgical needles, different sizes
- 1 needle case 50 x 25 mm, perforated
- 1 Michel suture clip forceps
- 20 Michel suture clips 14 x 3 mm, on clip holder
- 1 scalpel handle, no. 4
- 3 scalpel blades, different sizes
- 1 operating scissors, straight, sharp/blunt 13 cm
- 1 dressing forceps, delicate, 12,5 cm
- 1 protection pouch, plastic

Estuche de bolsillo "Mini-Assistent", completo en caja metálica compuesto de:

- 1 Mathieu porta-agujas, 14 cm
- 1 paquete de seda, estéril
- 3 agujas para suturas, diferentes tamaños
- 1 cajita perforada para agujas 50 x 25 mm
- 1 Michel pinza para agrafes
- 20 Michel agrafes 14 x 3 mm, en dispositivo
- 1 mango de bisturi, no.4
- 3 hojas de bisturi, diferentes tamaños
- 1 tijera, recta, aguda/roma, 13 cm
- 1 pinza de disección, fina, 12,5 cm
- 1 bolsa de protección, plástico

Set per sutura cutanea "Mini-Assistent", completo, in contenitore metallico composto di:

- 1 portaghi Matthieu, 14 cm
- 1 flacone di seta sutura, sterile
- 3 aghi assortiti per sutura
- 1 astuccio per aghi, 50 x 25 mm
- 1 pinza per agrafes Michel
- 20 agrafes Michel 14 x 3 mm, con supporto
- 1 manico per bisturi no.4
- 3 lame per bisturi, assortite
- 1 forbice chirurgica, retta, smussa/appuntita, 13 cm
- 1 pinza anatomica, fina, 12,5 cm
- 1 busta protettiva in plastica

020

**Verband, Gips
Dressing, Plaster
Vendajes, Escayolas
Bendaggi, Gessatura**



**LISTER**

1480-0709	9,0 cm / 3 1/2"
1480-0711	11,0 cm / 4 3/8"
1480-0714	14,0 cm / 5 1/2"
1480-0716	16,0 cm / 6 1/4"
1480-0718	18,0 cm / 7"
1480-0720	20,0 cm / 8"



für Linkshänder
for left-handed
para zurdos
per mancini

LISTER

1480-0714 L	14,0 cm / 5 1/2"
1480-0718 L	18,0 cm / 7"
1480-0720 L	20,0 cm / 8"

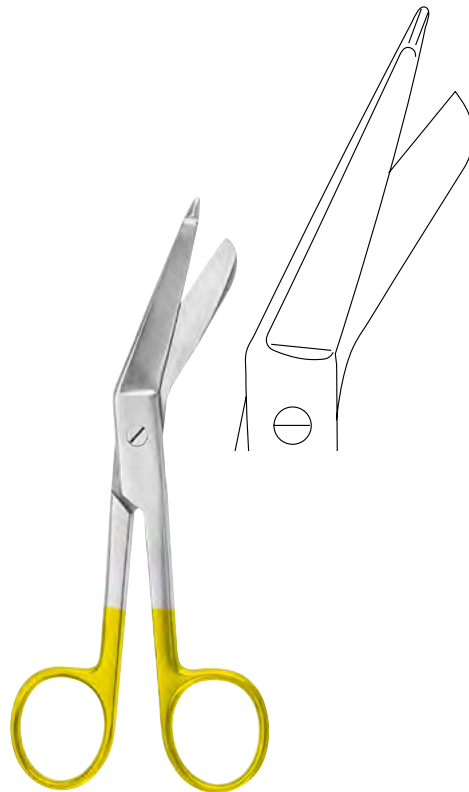
**LISTER**

1480-0914	14,0 cm / 5 1/2"
1480-0918	18,0 cm / 7"



LISTER

1480-2115 15,0 cm / 6"
1480-2118 18,0 cm / 7"



LISTER

1480-2515 15,0 cm / 6"
1480-2518 18,0 cm / 7"



LISTER

1480-2915 15,0 cm / 6"
1480-2918 18,0 cm / 7"



LISTER

1480-2315 15,0 cm / 6"
1480-2318 18,0 cm / 7"



LISTER

1480-2715 15,0 cm / 6"
1480-2718 18,0 cm / 7"



LISTER

1480-0820 20,0 cm / 8"



EXCENTRIC

1480-1116 16 cm / 5 1/2"



KNOWLES

1480-0514 14,0 cm / 5 1/2"



KNOWLES

1480-0614 14,0 cm / 5 1/2"

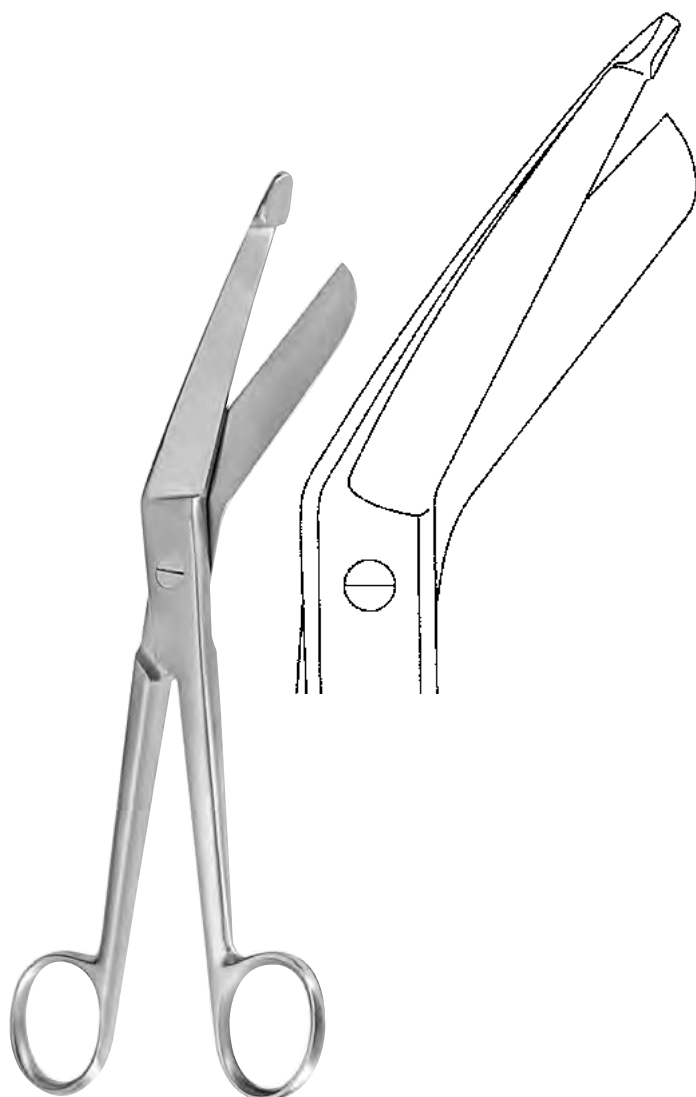

BERGMANN

1480-1523 23,0 cm / 9"



LORENZ

1480-1623 23,0 cm / 9"

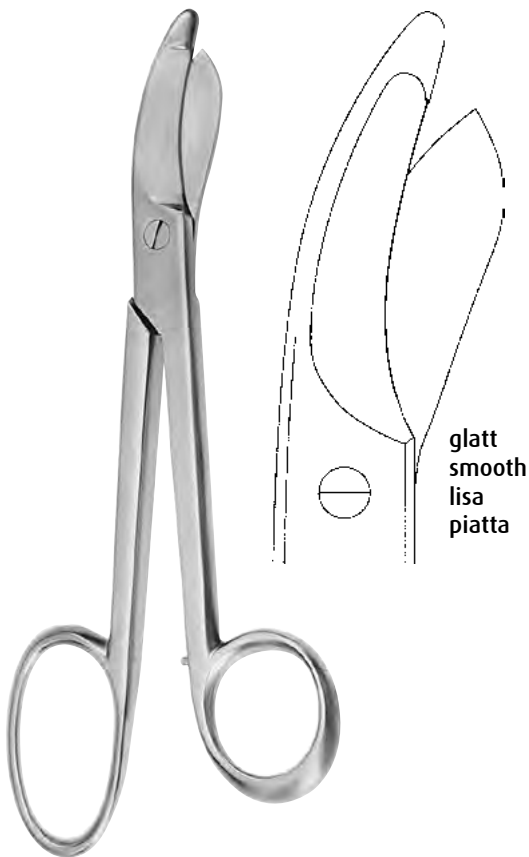

glatt
smooth
lisa
piatta

BRUNS

1480-1723 24,0 cm / 9 1/2"

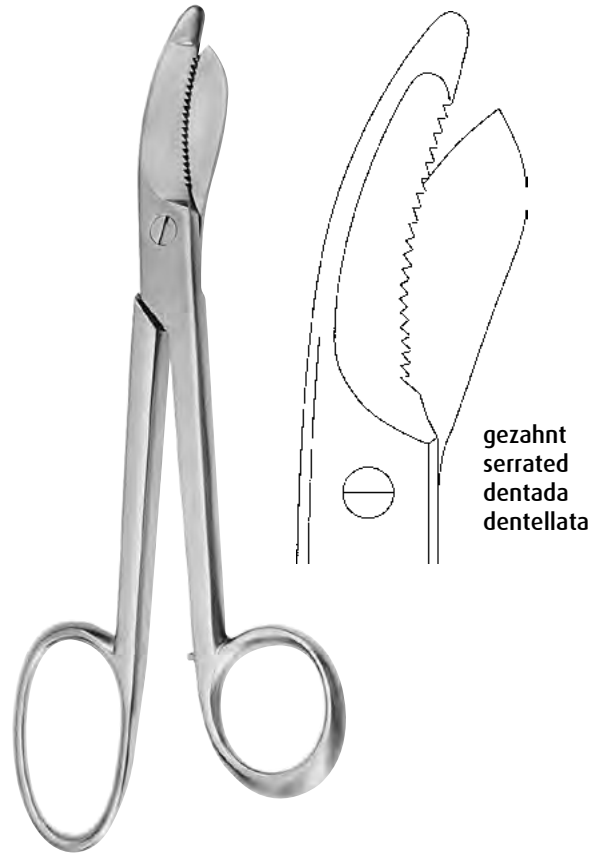

gezahnt
serrated
dentada
dentellata

BRUNS

1480-1724 24,0 cm / 9 1/2"

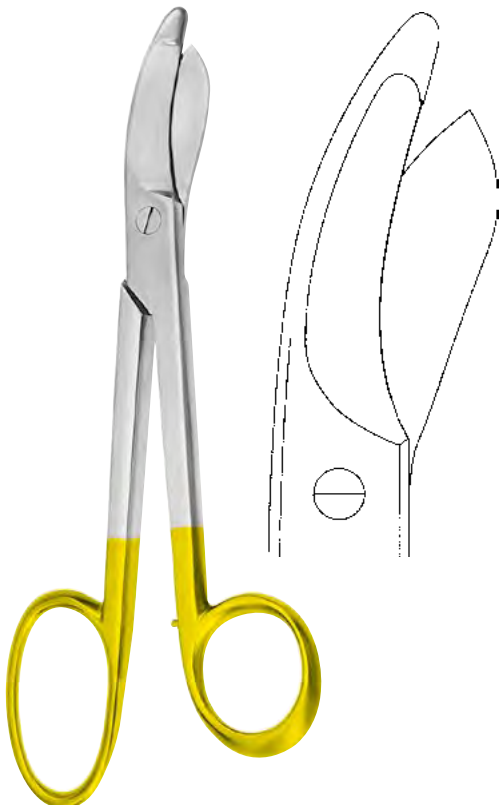

BRUNS

1480-1923 24,0 cm / 9 1/2"

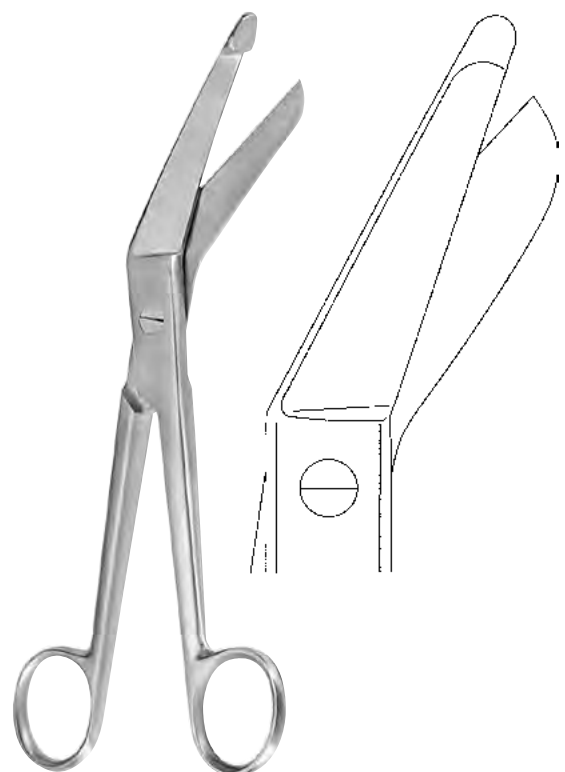

ESMARCH

1480-1320 20,0 cm / 8"
1480-1323 22,0 cm / 8 3/4"

Verbandsscheren
Bandage Scissors
Tijeras para vendajes
Cesoie per bendaggi

020



SEUTIN

1480-3023 23,0 cm / 9"

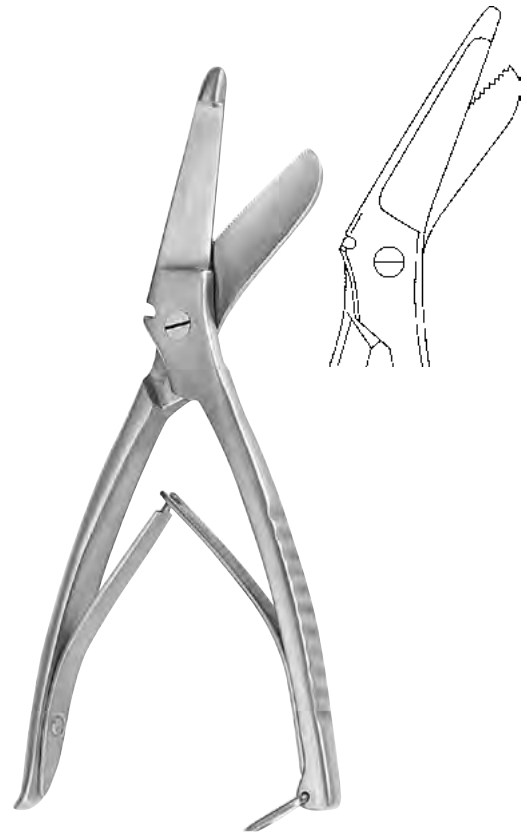

1480-3020 20,0 cm / 8"



STILLE

1480-3224 24,0 cm / 9½"



STILLE

1480-3323 23,0 cm / 9"
1480-3326 26,0 cm / 10¼"
1480-3337 37,0 cm / 14½"

**ENGEL**

1480-4614 14,0 cm / 5 1/2"

**BERGMANN**

1480-4618 18,0 cm / 7"

**HOPKINS**

1480-4820 20,0 cm / 8"

**ESMARCH**

1480-5018 18,0 cm / 7"

**REINER**

1480-5218 18,5 cm / 7 1/4"



MOD. USA

1480-4423 23,0 cm / 9"



HENNIG

1480-4028 28,0 cm / 11"



WOLFF

1480-4518 18,0 cm / 7"
1480-4524 24,0 cm / 9½"

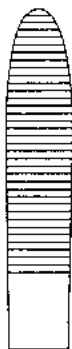

1480-4518



1480-4524



1481-0001 110 Volt
1481-0000 230 Volt

komplett, mit 2 Spannschlüsseln (1480-1001),
1 Sägeblatt (1481-1065) und 1 Sägeblatt (1481-1050).

complete, with 2 spanners (1480-1001),
1 sawblade (1481-1065) and 1 sawblade (1481-1050).

completo, con 2 llaves (1480-1001),
1 hoja (1481-1065) y 1 hoja (1481-1050).

completo, con 2 chiavi (1480-1001),
1 lama (1481-1065) y 1 lama (1481-1050).

1480-1001

Spannschlüssel
Spanners
Llaves inglesas
Chiavi inglese



1481-1050 Ø 50 mm

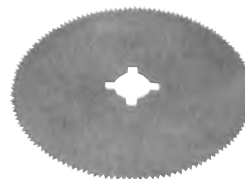

1481-1065 Ø 65 mm



1481-2050 Ø 50 mm

Spezialgehärtet
Special hardness
templada especial
tempra speciale

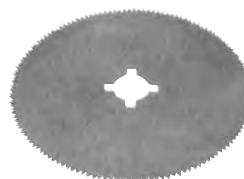

1481-2065 Ø 65 mm

Spezialgehärtet
Special hardness
templada especial
tempra speciale

021

Knochenchirurgie
Bone Surgery
Cirurgía ósea
Chirurgia ossea





1401-2204 4 mm



1401-2206 6 mm

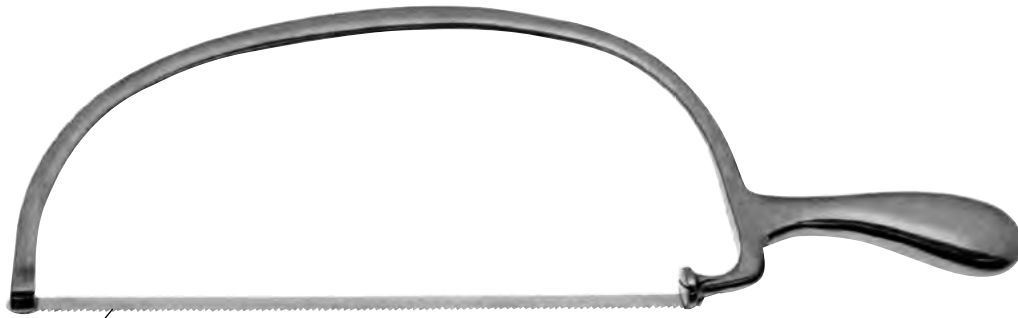

1401-2208 8 mm

BIER

1401-2200 40,5 cm / 16"

komplett
 complete
 completo
 completo



1401-2112 12 mm



1401-2108 8 mm



1401-2106 6 mm

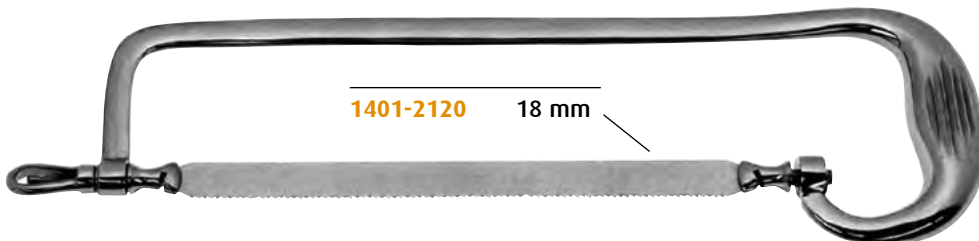

1401-2120 18 mm

RUST

1401-2100 39,0 cm / 15 1/2"

komplett mit 4 Sägeblättern (1 x 1401-2106, 1 x 1401-2108, 2 x 1401-2112)
 complete with 4 Saw blades (1 x 1401-2106, 1 x 1401-2108, 2 x 1401-2112)
 completo con 4 hojas de sierra (1 x 1401-2106, 1 x 1401-2108, 2 x 1401-2112)
 completo con 4 lame di seghe (1 x 1401-2106, 1 x 1401-2108, 2 x 1401-2112)



1401-2012 12 mm

1401-2015 15 mm

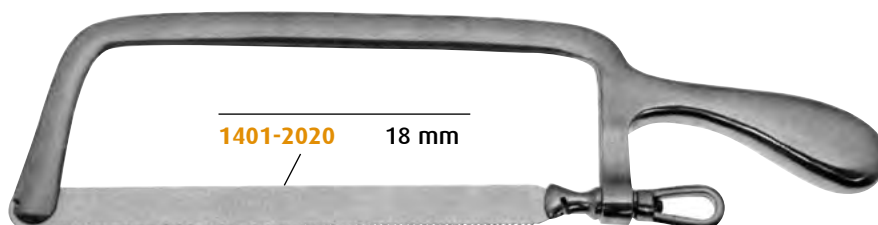

1401-2020 18 mm

CHARRIÈRE

1401-2000 35,0 cm / 13³/₄"

komplett
 complete
 completo
 completo



LANGENBECK

1401-2800 23,5 cm / 9¹/₄"



CHARRIÈRE

1401-3001 20,0 cm / 8"

Ersatzblatt für 1401-3000
 Spareblade for 1401-3000
 hoja de repuesto para 1401-3000
 Lama di ricambio per 1401-3000

1401-2400 27,0 cm / 10³/₄"

1401-3000 30,0 cm / 11³/₄"

1401-2401 15,0 cm / 6"

Ersatzblatt für 1401-2400
 Spareblade for 1401-2400
 hoja de repuesto para 1401-2400
 Lama di ricambio per 1401-2400



SATTERLEE

1401-2600 29,0 cm / 11¹/₄"

1401-2699 20,0 cm / 8"

Ersatzblatt
 Spareblade
 hoja de repuesto
 Lama di ricambio



1100-4500

Komprimeter zur Erzeugung einer Blutleere in den Extremitäten,
Manometer mit Meßbereich bis 700 mm Hg, komplett, bestehend aus:
Luftpumpe (1100-4504) mit Manometer (1100-4505)
Oberschenkel-Manschette (1100-4502) 960 x 130 mm
Oberarm-Manschette (021-050-004) 570 x 90 mm

1100-4500

Comprimeter, Compression apparatus for producing exsanguination in the extremities,
Manometer registers up to 700 mm Hg. Complete, consisting of:
Pump (1100-4504) with manometer (1100-4505)
Cuff for the leg (1100-4502) 960 x 130 mm
cuff for the upper arm (1100-4501) 570 x 90 mm

1100-4500

Torniquete para producir una isquemia local en las extremidades,
Manómetro con rango de medición hasta 700 mm Hg, completo, compuesto de:
Bomba de aire (1100-4504) con manómetro (1100-4505)
Brazalete para el muslo (1100-4502) 960 x 130 mm
Brazalete para el brazo (1100-4501) 570 x 90 mm

1100-4500

Apparecchio per arrestare il sangue nelle estremità,
Manometro con campo di misura fino a 700 mm Hg, completo, composto da:
Pompa aria (1100-4504) con manometro (1100-4505)
Bracciale (1100-4502) 960 x 130mm
Cosciale (1100-4501) 570 x 90 mm



ESMARCH

1100-2506 500 x 6 cm

Staubinde
Compression bandage
Venda-compresiòn
Fascia per ischemia

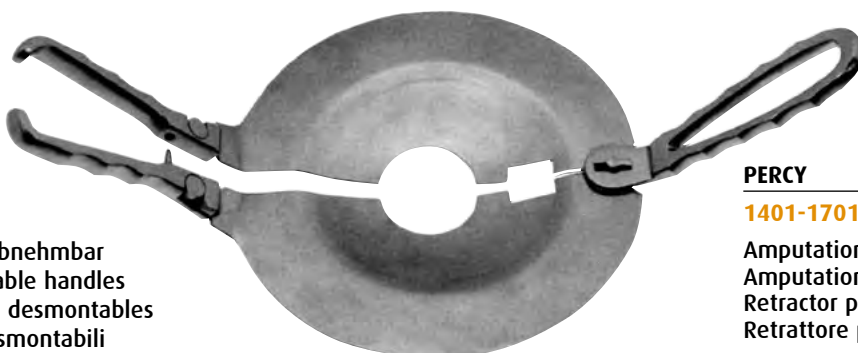

Griffe abnehmbar
Removable handles
Mangos desmontables
manici smontabili

PERCY

1401-1701

Amputationsretraktor
Amputation Retractor
Retractor para amputaciòn
Retrattore per amputazione

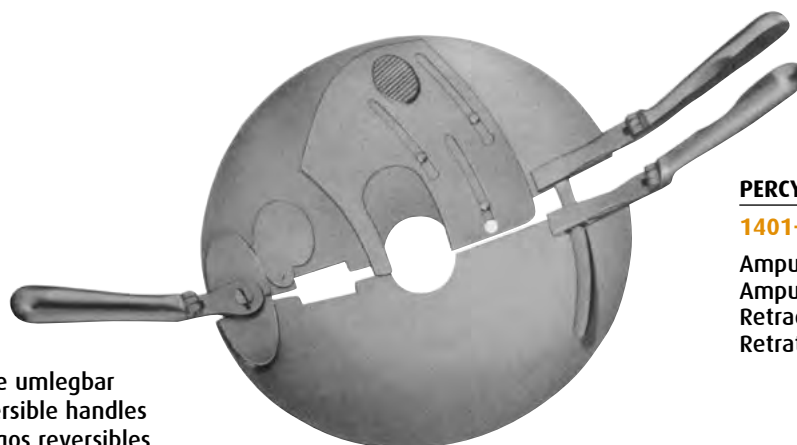

Griffe umlegbar
Reversible handles
Mangos reversibles
Manici reversibili

PERCY

1401-1801

Amputationsretraktor
Amputation Retractor
Retractor para amputaciòn
Retrattore per amputazione

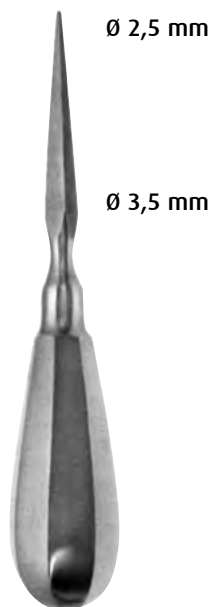

1401-5014 14,0 cm / 5 1/2"
1401-5016 16,0 cm / 6 1/4"



PERTHES

1401-5418 18,0 cm / 7"



PERTHES

1401-5621 21,5 cm / 8 1/2"



1401-5214 14,0 cm / 5 1/2"

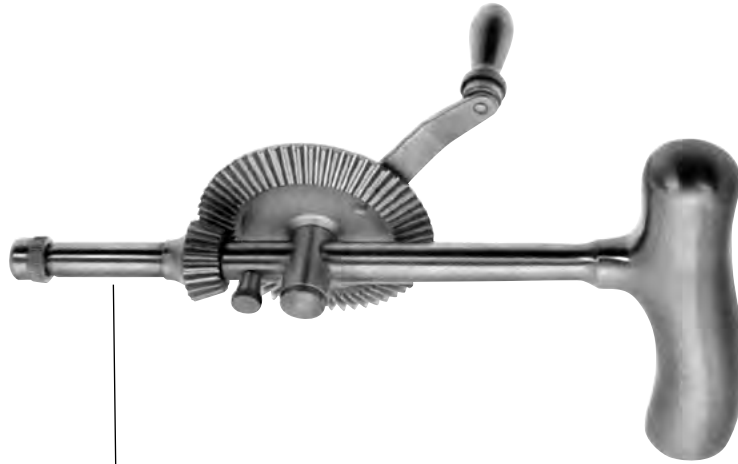

1409-1211

Handbohrapparat, allein
 Hand Bone Drill, only
 Perforadore de mano, suelta
 Trapano a mano per ossa, solo

STILLE

1409-1200

komplett mit 4 Bohrer, 4 Fräsern, 1 Trepine
 complete with 4 drills, 4 burrs, 1 trephine
 completo con 4 taladros, 4 fresas, 1 trepano
 completo con 4 punte, 4 frese sferica, 1 fresa



1409-1201 Ø 1,0 mm



1409-1215 Ø 1,5 mm



1409-1220 Ø 2,0 mm



1409-1225 Ø 2,5 mm



1409-1230 Ø 3,0 mm



1409-1235 Ø 3,5 mm



1409-1240 Ø 4,0 mm



1409-1210 Ø 10,0 mm



1409-1205 Ø 5,0 mm



1409-1208 Ø 8,0 mm



1409-1212 Ø 12,0 mm



1409-1216 Ø 16,0 mm

**HUDSON****1409-1799**

Handbohrapparat mit Schnellverschluß, allein
 Hand Bone Drill with quick lock, only
 Perforador de mano con cierre rapido, suelto
 Trapano a mano con chiusura presta, solo

HUDSON**1409-1600**

komplett mit Verlängerungsstück und 4 Fräsern
 complete with extension piece and 4 burrs
 completo con pieza de prolongacion y 4 fresas
 completo con giunto di prolungamento e 4 frese

**1409-1609**

Verlängerungsstück
 Extension piece
 Pieza de prolongación
 Giunto di prolungamento

**1409-1601** Ø 9,0 mm**1409-1602** Ø 14,0 mm**1409-1603** Ø 16,0 mm**1409-1604** Ø 22,0 mm**CUSHING****1409-1605** Ø 13,0 mm**ADSON****1409-1606** Ø 2,4 mm**MC KENZIE****1409-1607** Ø 13,0 mm**D'ERRICO****1409-1608** Ø 16,0 mm**1409-1790**

Spannschlüssel, allein
 Wrench, only
 Llave, suelta
 Chiave, sola

**1409-1791** 16,0 cm / 6 1/4"



BUNNELL

1409-1800

längsdurchgebohrt, zur Aufnahme von Bohrdrähten und Nägeln
cannulated, for taking wire drills and nails
barrenado oblongo, para agujas y clavos
tubolare, per inserire fili e chiodi

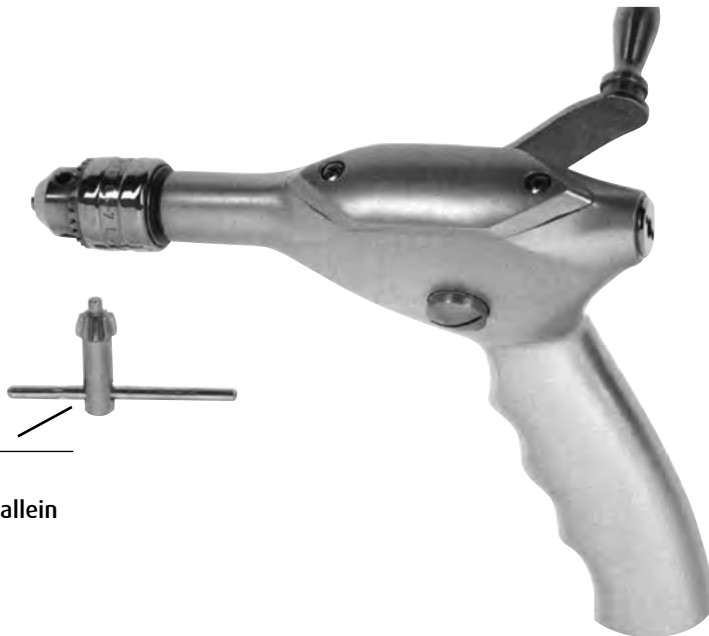

1409-1790

Spannschlüssel, allein
Wrench, only
Llave, suelta
Chiave, sola

RALK

1409-1900

längsdurchgebohrt, zur Aufnahme von Bohrdrähten und Nägeln
cannulated, for taking wire drills and nails
barrenado oblongo, para agujas y clavos
tubolare, per inserire fili e chiodi



LOWMAN

1405-6212	12,0 cm / 4 ³ / ₄ "	a = 19,0 mm
1405-6218	18,0 cm / 7"	a = 25,0 mm
1405-6220	20,0 cm / 8"	a = 29,0 mm

LOWMAN

1405-6112	12,0 cm / 4 ³ / ₄ "	a = 19,0 mm
1405-6118	18,0 cm / 7"	a = 25,0 mm
1405-6120	20,0 cm / 8"	a = 29,0 mm
1405-6122	22,0 cm / 8 ³ / ₄ "	a = 31,0 mm



a = 29,0 mm



LOWMAN-LAMBERT
1405-6321 21,0 cm // 8¹/₄"



a = 25,0 mm

1 Maulteil beweglich
 1 jaw swiveled
 1 boca movable
 1 musso mobile

LOWMAN-HOGLUND
1405-6318 18,0 cm // 7"

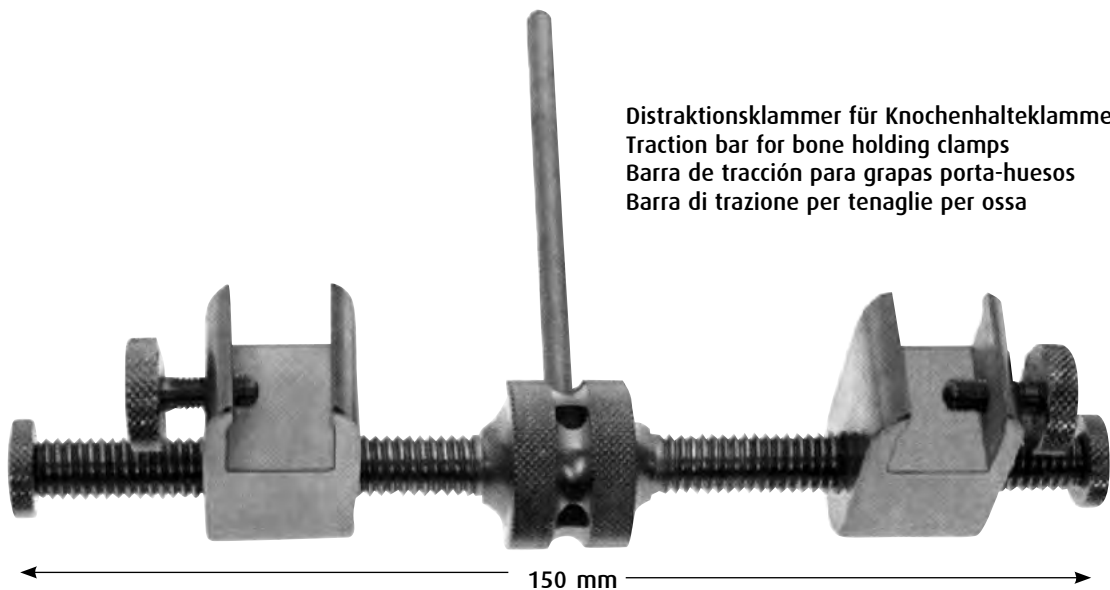

Distractionsklammer für Knochenhalteklammern
 Traction bar for bone holding clamps
 Barra de tracción para grapas porta-huesos
 Barra di trazione per tenaglie per ossa

GERSTER
1405-6400

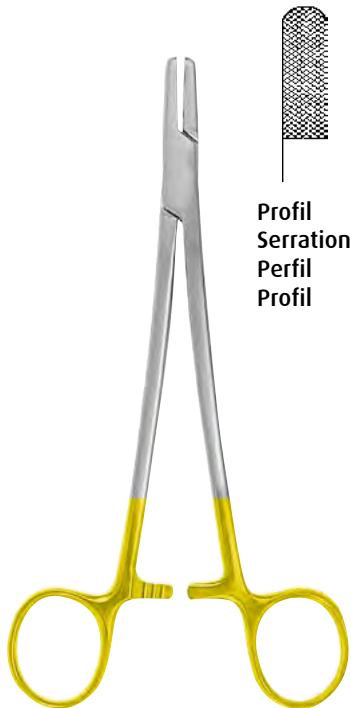

Profil
 Serration
 Perfil
 Profil

BARRY-STERNDAL

1408-3618 18,5 cm / 7¹/₄"



Profil
 Serration
 Perfil
 Profil

1408-3415 15,0 cm / 6"
 1408-3680 20,0 cm / 8"



1408-3215 15,0 cm / 6"
 1408-2820 20,0 cm / 8"



Profil
 Serration
 Perfil
 Profil

CROWIN-HEGAR

1408-3816 16,0 cm / 6¹/₄"

Drahtfasszangen, Flachzangen
Wire Holding Forceps, Flat Nose Pliers
Alicates para extraer alambres, Alicates de pico plano
Tenaglie porta cavo, Tenaglie piatte

021

mit Längsrille
 with longitudinal groove
 con ranura longitudinal
 con scannelatura longitudinale



1408-5014 14,0 cm / 5¹/₄"

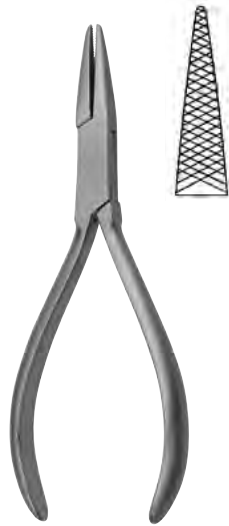

1408-5101 14,0 cm / 5¹/₄"



HACKSTOCK
1408-5216 16,0 cm / 6¹/₄"



1408-6515 18,0 cm / 7"

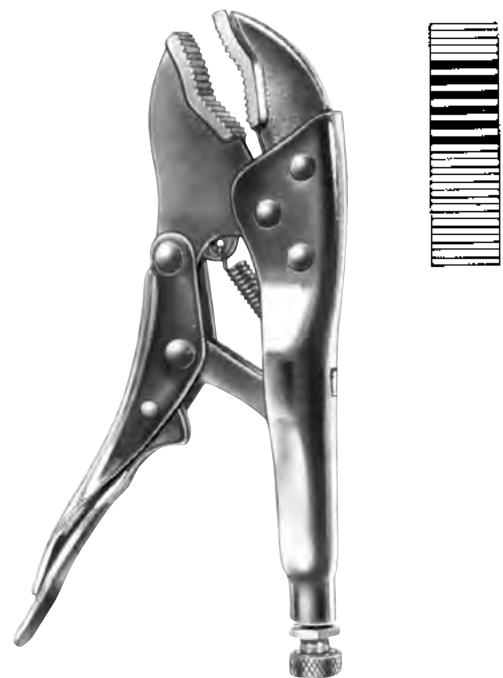

1408-5817 18,0 cm / 7"



1408-5401 17,0 cm / 6³/₄"



mit Kreuzrille
 with crosswire groove
 con ranura en forma de cruz
 con scannalatura a croce

1408-5402 17,0 cm / 6³/₄"

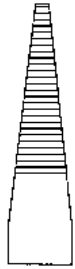

1408-5403 19,0 cm / 7¹/₂"

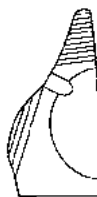
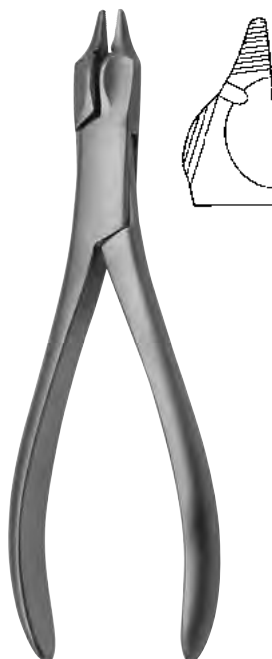

1408-7015 15,0 cm / 6"

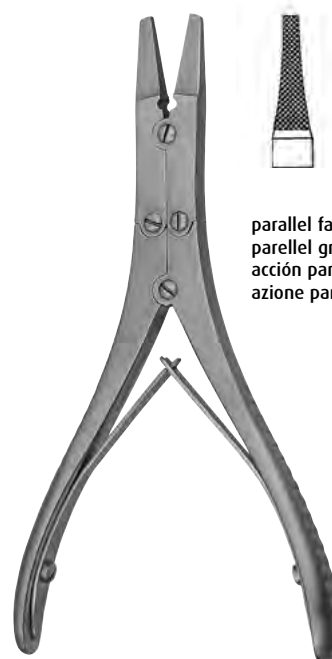

parallel fassend
 parallel grip
 acción paralela
 azione parallela

1408-6201 14,5 cm / 5³/₄"

Drahtfasszangen
Wire Holding Forceps
Alicates para extraer alambres
Tenaglie porta cavo

021



Fig. 1
1408-6211



Fig. 2
1408-6202



Fig. 3
1408-6203

Parallelschluß
 Parallel action
 Acción paralela
 Azione parallela

1408-6211 - 1408-6203 18,0 cm / 7"

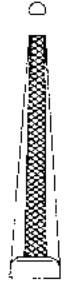

1408-6418 18,0 cm / 7"

TC

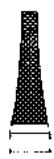

Fig. 1
1408-6301



Fig. 2
1408-6302



Fig. 3
1408-6303

Parallelschluß
 Parallel action
 Acción paralela
 Azione parallela

1408-6301 - 1408-6303 18,0 cm / 7"



für weiche Drähte bis 2,4 mm Ø
 for soft wires up to 2,4 mm Ø
 para alambres blandos hasta 2,4 mm Ø
 per fili molli fino a 2,4 mm Ø

für harte Drähte bis 1,6 mm Ø
 for hard wires up to 1,6 mm Ø
 para alambres duros hasta 1,6 mm Ø
 per fili metallici duri fino a 1,6 mm Ø

1408-7818 18,5 cm / 7¹/₄"



Kopfschneider
 Wire Cutter, front action
 Alicates frontal para corta alambre
 Tenaglie tagliafili frontali

für weiche Drähte bis 2,2 mm Ø
 for soft wires up to 2,2 mm Ø
 para alambres blandos hasta 2,2 mm Ø
 per fili molli fino a 2,2 mm Ø

für harte Drähte bis 2,0 mm Ø
 for hard wires up to 2,0 mm Ø
 para alambres duros hasta 2,0 mm Ø
 per fili metallici duri fino a 2,0 mm Ø

DIAMANT

1408-7617 16,0 cm / 6¹/₄"

TC

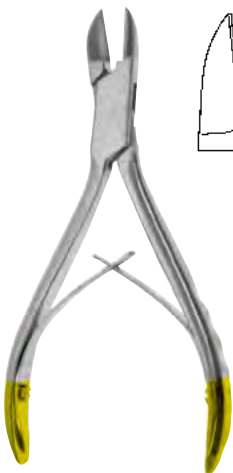

für weiche Drähte bis 0,6 mm Ø
 for soft wires up to 0,6 mm Ø
 para alambres blandos hasta 0,6 mm Ø
 per fili molli fino a 0,6 mm Ø

für harte Drähte bis 0,4 mm Ø
 for hard wires up to 0,4 mm Ø
 para alambres duros hasta 0,4 mm Ø
 per fili metallici duri fino a 0,4 mm Ø

1408-7125 12,5 cm / 5"



1408-9047 47,0 cm / 18¹/₄"

Bolzenschneider zum Abzwicken von Drähten, Schrauben und Nägeln bis Ø 6 mm
 Cutters for cutting of wires, screws and pins up to diam, 6 mm
 Alicates corta-alambres, tornillos y clavos hasta Ø 6 mm
 Cesovia per cavi, viti e perni, con Ø superiore a 6 mm

TC-Drahtkneifzangen
TC-Wire Cutting Pliers
TC-Alicates corta-alambres
TC-Tenaglie tagliafili

021

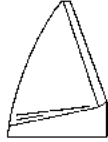
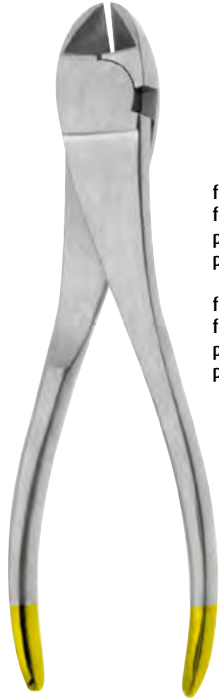

für weiche Drähte bis 2,0 mm Ø
 for soft wires up to 2,0 mm Ø
 para alambres blandos hasta 2,0 mm Ø
 per fili molli fino a 2,0 mm Ø

für harte Drähte bis 1,7 mm Ø
 for hard wires up to 1,7 mm Ø
 para alambres duros hasta 1,7 mm Ø
 per fili metallici duri fino a 1,7 mm Ø

1408-7716 18,5 cm / 7¹/₄"

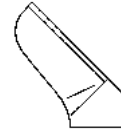

1408-7316

für weiche Drähte bis 2,0 mm Ø
 for soft wires up to 2,0 mm Ø
 para alambres blandos hasta 2,0 mm Ø
 per fili molli fino a 2,0 mm Ø

für harte Drähte bis 1,7 mm Ø
 for hard wires up to 1,7 mm Ø
 para alambres duros hasta 1,7 mm Ø
 per fili metallici duri fino a 1,7 mm Ø

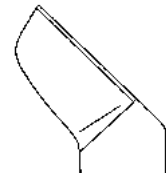

1408-7322

für weiche Drähte bis 2,8 mm Ø
 for soft wires up to 2,8 mm Ø
 para alambres blandos hasta 2,8 mm Ø
 per fili molli fino a 2,8 mm Ø

für harte Drähte bis 2,2 mm Ø
 for hard wires up to 2,2 mm Ø
 para alambres duros hasta 2,2 mm Ø
 per fili metallici duri fino a 2,2 mm Ø

1408-7316 17,5 cm / 7"
1408-7322 22,0 cm / 8³/₄"



Kopf- und Seitenschneider
Wire Cutting Plier
Alicates para cortar alambre
Tenaglia tagliafili

für weiche Drähte bis 2,0 mm Ø
 for soft wires up to 2,0 mm Ø
 para alambres blandos hasta 2,0 mm Ø
 per fili molli fino a 2,0 mm Ø

für harte Drähte bis 1,7 mm Ø
 for hard wires up to 1,7 mm Ø
 para alambres duros hasta 1,7 mm Ø
 per fili metallici duri fino a 1,7 mm Ø

1408-8618 18,0 cm / 7"



für harte Drähte bis 2,2 mm Ø
 for hard wires up to 2,2 mm Ø
 para alambre duros hasta 2,2 mm Ø
 per fill duri fino a 2,2 mm Ø

1408-9618 18,0 cm / 7"



1408-9623

für harte Drähte bis 3,0 mm Ø
 for hard wires up to 3,0 mm Ø
 para alambre duros hasta 3,0 mm Ø
 per fill duri fino a 3,0 mm Ø

1408-9628

für harte Drähte bis 2,5 - 4,0 mm Ø
 for hard wires up to 2,5 - 4,0 mm Ø
 para alambre duros hasta 2,5 - 4,0 mm Ø
 per fill duri fino a 2,5 - 4,0 mm Ø

1408-9623 23,0 cm / 9"
1408-9628 28,0 cm / 11"



Ersatzteilset: 1 Paar TC-Ersatzschneiden,
 2 Paar Schrauben, 1 Inbusschlüssel
Spare Part Set: 1 pair of TC-blades, 2 pairs
 of screws, 1 Allen key
Juego de recambio: 1 par de placas de
 Tungsteno, 2 pares de tornillos, 1 llave
 Hexagonal
Set di ricambio: 1 paio di lami di TC,
 2 paio di viti, 1 chiave a brugola

1408-8998 für/for/para/per 021-460-180
1408-8999 für/for/para/per 021-460-230 und -280



Ersatzteilset: 1 Paar Gummibacken,
 1 Paar Schrauben
Spare Part Set: 1 pair of rubber jaws,
 1 pairs of screws
Juego de recambio: 1 par de bocas de
 goma, 1 par de tornillos
Set di ricambio: 1 paio di guance
 di plastica

1408-8989 für/for/para/per 021-460-180,
 021-460-230 und -280



für weiche Drähte bis 3,0 mm Ø
 for soft wires up to 3,0 mm Ø
 para alambre blandos hasta 3,0 mm Ø
 per fili molli fino a 3,0 mm Ø

für harte Drähte bis 2,0 mm Ø
 for hard wires up to 2,0 mm Ø
 para alambre duros hasta 2,0 mm Ø
 per fili duri fino a 2,0 mm Ø

1408-8622 22,0 cm / 8³/₄"

Drähte, Drahtspanner, Drahtspannzange
Bone Wires, Wire Tightener, Wire Twisting Forceps
Alambres para huesos, Tensor cierra-hilo, Pinza cierra-hilo
Fili per ossa, Trenditore serra filo, Pinza gira cavo

021

Cerclage-Drähte, weich, in Ringen zu 10 m
 Bone wires, soft, in coils of 10 m
 Hilos de cerclaje, blandos, en rollos de 10 m
 Filo per ossa, leggero, in rotolo di 10 m



1408-2102	Ø 0,2 mm
1408-2103	Ø 0,3 mm
1408-2104	Ø 0,4 mm
1408-2105	Ø 0,5 mm
1408-2106	Ø 0,6 mm
1408-2107	Ø 0,7 mm
1408-2108	Ø 0,8 mm
1408-2109	Ø 0,9 mm
1408-2110	Ø 1,0 mm
1408-2112	Ø 1,2 mm
1408-2115	Ø 1,5 mm



Drahtspanner mit an der Spitze
 eingebauter beweglicher Drahtspannbüchse für
 Cerclage-Drähte bis ø 1 mm

Wire tightener, with movable tip, for wires up
 to 1,0 mm diam.

Tensor cierra-hilo con manguito movable en la
 punta, para hilos de cerclaje hasta ø 1 mm

Trenditore serra filo con manico mobile sulla
 punta, per fili di cerchiaggio da 1 mm, di ø

LOUTE

1408-2222 21,0 cm / 8¹/₄"



DEMEL

1408-2427 27,0 cm / 10³/₄"

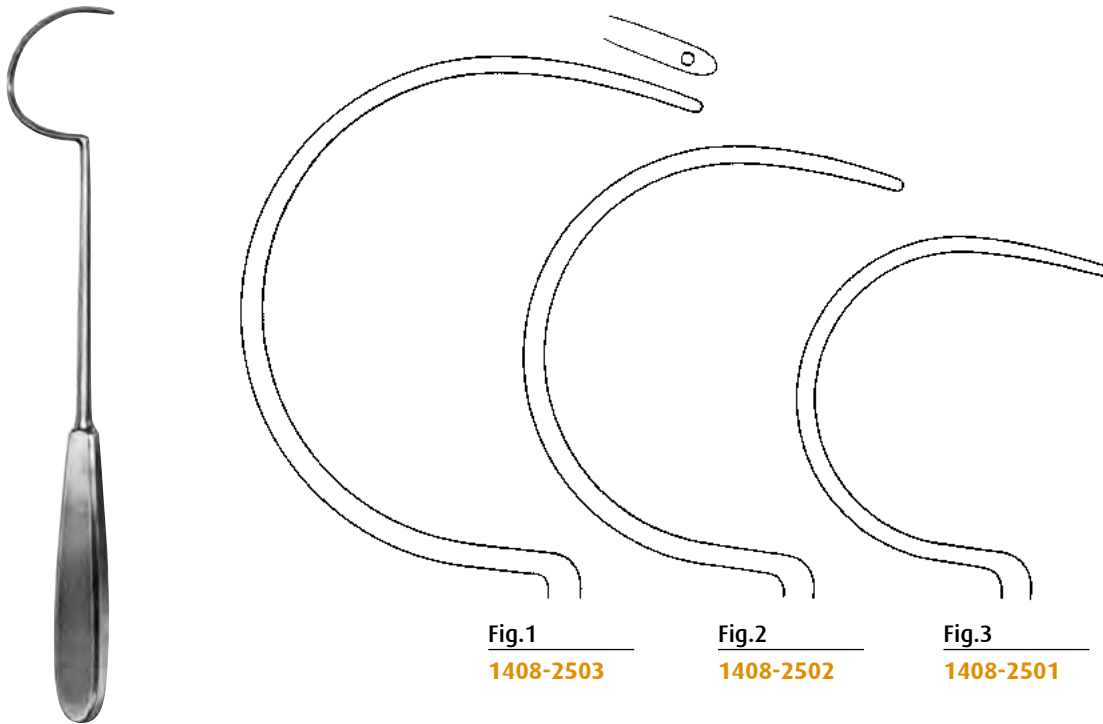

Fig.1
1408-2503

Fig.2
1408-2502

Fig.3
1408-2501

DEMEL

1408-2503	31,0 cm / 12 ¹ / ₄ "
1408-2502	29,0 cm / 11 ¹ / ₄ "
1408-2501	28,0 cm / 11"

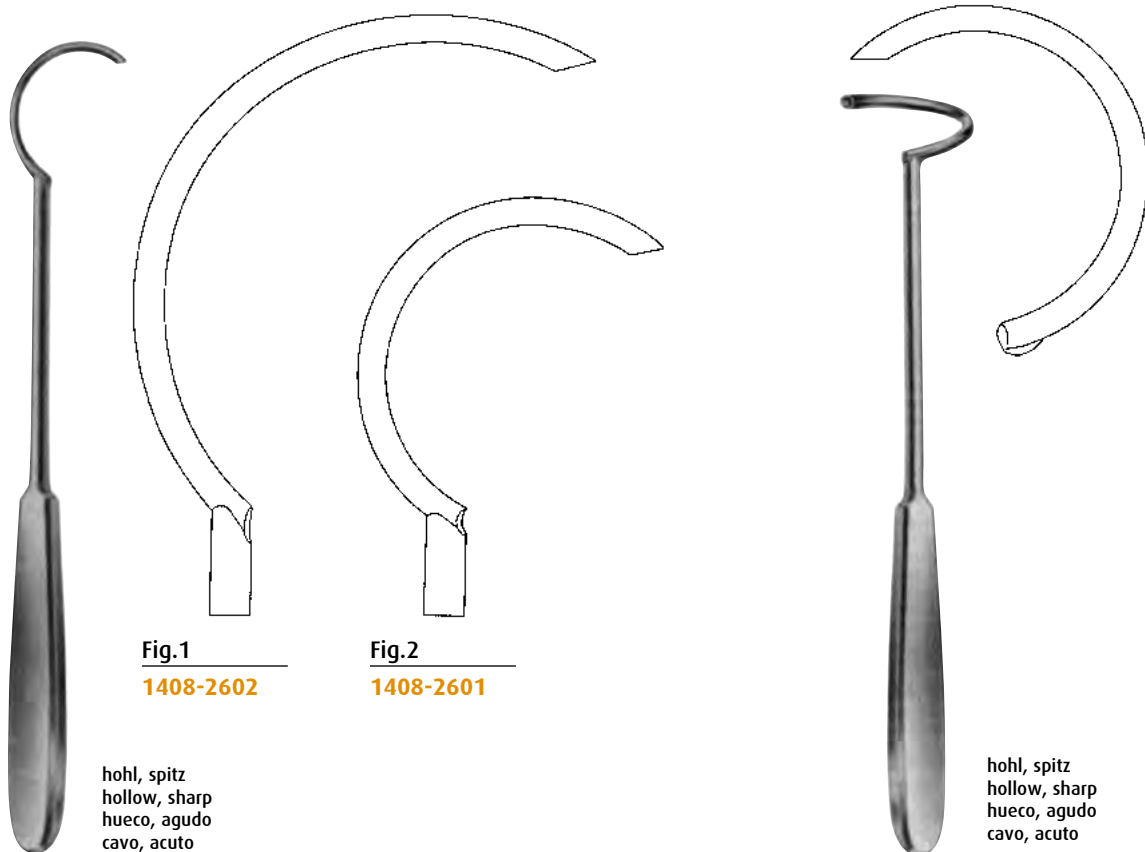

Fig.1
1408-2602

Fig.2
1408-2601

hohl, spitz
 hollow, sharp
 hueco, agudo
 cavo, acuto

hohl, spitz
 hollow, sharp
 hueco, agudo
 cavo, acuto

1408-2602	27,0 cm / 10 ³ / ₄ "
1408-2601	24,0 cm / 9 ¹ / ₂ "

1408-2701	22,5 cm / 9"
------------------	--------------

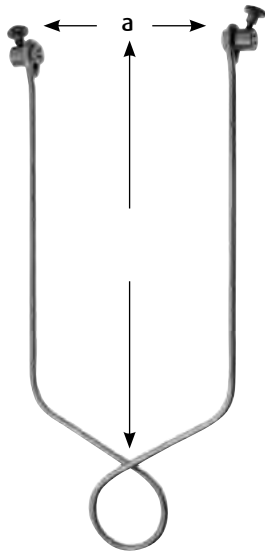

komplett mit STEINMANN Nagel Ø 4 mm
 complete with STEINMANN pin, Ø 4 mm
 completo con clavo STEINMANN Ø 4 mm
 completo con chiodo STEINMANN, Ø 4 mm

BÖHLER	a	b	
1408-0401	90 mm	160 mm	für Arm / for arm / para brazo / per braccio
1408-0402	110 mm	210 mm	für Oberschenkel und Knie / for femur and knee / para fémur y rodilla / per femore e ginocchio
1408-0403	150 mm	210 mm	für Oberschenkel und Knie / for femur and knee / para fémur y rodilla / per femore e ginocchio

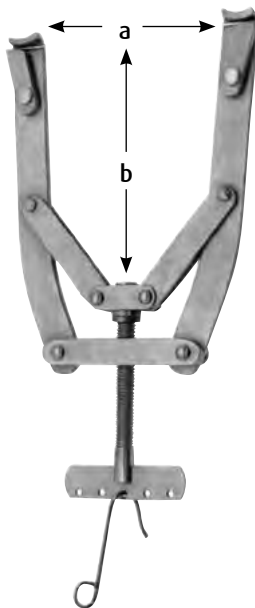

Extensionsbügel mit 1 Zughaken, zur Verwendung mit KIRSCHNER Drähten bis Ø 1,6 mm (1408-0300), Ø 2,0 mm (1408-0301), Ø 2,5 mm (1408-0302), verstellbar, selbsthemmend.

Wire traction bow with 1 traction hook, to be used with KIRSCHNER wires up to Ø 1,6 mm (1408-0300), Ø 2,0 mm (1408-0301), Ø 2,5 mm (1408-0302), adjustable, holds wire securely.

Estribo para extensión con 1 gancho de tracción, para agujas de KIRSCHNER hasta Ø 1,6 mm (1408-0300), Ø 2,0 mm (1408-0301), Ø 2,5 mm (1408-0302), ajustable, sujeto seguro de la aguja.

Archi per trazione con 1 ganci di trazione, da impiegarsi con fili KIRSCHNER superiori a Ø 1,6 mm (1408-0300), Ø 2,0 mm (1408-0301), Ø 2,5 mm (1408-0302), regolabile, fili in sicurezza.

KIRSCHNER	a	b
1408-0300	0-105 mm	80-95 mm
1408-0301	0-160 mm	90-120 mm
1408-0302	0-200 mm	140-170 mm



Extensionsbügel mit 3 Zughaken, zur Verwendung mit KIRSCHNER Drähten bis \varnothing 2,5 mm (großes Modell), und \varnothing 2,0 mm (kleines Modell), verstellbar.

Wire traction bow with 3 traction hooks, to be used with KIRSCHNER wires up to 2,5 mm \varnothing (large size), and up to 2,0 mm \varnothing (small size), adjustable.

Estribo para extensión con 3 ganchos de tracción, para agujas de KIRSCHNER hasta \varnothing 2,5 mm (modelo grande), y \varnothing 2,0 mm (modelo pequeño), ajustable.

Archi per trazione con 3 ganci di trazione, da impiegarsi con fili KIRSCHNER superiori a 2,5 mm di \varnothing (misura grande), e 2,0 mm di \varnothing (misura piccola), regolabile.

	a	b
1408-0201	40-130 mm	100 mm
1408-0203	80-260 mm	150 mm



Zughaken, klein
 Traction Hook, small
 Gancho de tracción, pequeño
 Ganci di trazione, piccolo

1408-0700



Zughaken, groß
 Traction Hook, large
 Gancho de tracción, grande
 Ganci di trazione, largo

1408-0800



Begrenzungsplatte, paar
 Fixation disc, pair
 Disco fijador, par
 Disco di fissaggio, paio

1408-1000



Fixierscheiben, paar
 Fixation discs, pair
 Discos fijadores, par
 Dischi di fissaggio, paio

1408-0900



1408-0600

Bohrhandgriff
Drill handle
Perforador de mano
Perforatore a mano

021



VICKERS-EASYDRIVER

1408-1200 14,0 cm / 5 1/2"

**STEINMANN**

1424-1408	Ø 4,0 x 80 mm
1424-1410	Ø 4,0 x 100 mm
1424-1412	Ø 4,0 x 120 mm
1424-1414	Ø 4,0 x 140 mm
1424-1415	Ø 4,0 x 150 mm
1424-1416	Ø 4,0 x 160 mm
1424-1418	Ø 4,0 x 180 mm
1424-1420	Ø 4,0 x 200 mm
1408-0210	Ø 4,0 x 210 mm
1408-0250	Ø 4,0 x 250 mm

Spannschlüssel mit Klemmbacke
 Wire tightener, with clamping jaws
 Tensor de alambres
 Strumento tenditore con morso a presa



1408-0500



Extensionsbügel mit 3 Zughaken, zur Verwendung
 mit KIRSCHNER Drähten bis Ø 2,5 mm.

Wire traction bows with 3 Traction hooks, to be used
 with KIRSCHNER wires up to 2,5 mm diam.

Estribos para extensión con 3 ganchos de tracción,
 para agujas de KIRSCHNER hasta Ø 2,5 mm.

Archi per trazione con 3 ganci di trazione, da impiegarsi
 con fili KIRSCHNER superiori a 2,5 mm di Ø.

KIRSCHNER	a	b	
1408-0101	95 mm	70 mm	für Arm und Ellenbogen / for arm and elbow / para brazo y codo / per braccio e gomito
1408-0102	95 mm	110 mm	für Fersenbein / for calcaneus / para calcáneo / per calcagno
1408-0103	105 mm	100 mm	für Knie / for knee / para rodilla / per ginocchio
1408-0104	120 mm	120 mm	für Knie / for knee / para rodilla / per ginocchio
1408-0105	135 mm	130 mm	für Knie / for knee / para rodilla / per ginocchio
1408-0106	155 mm	155 mm	für Oberschenkel / for femur / para fémur / per femore
1408-0107	200 mm	155 mm	für Hüfte / for hip / para coxa / per anca



Bohrdrähte mit beidseitiger Trokarspitze, in Packungen zu 10 Stk.
 Wire drills with trocar point on each end, in packages of 10 pieces
 Agujas con dos puntas trocar, en paquete de 10 piezas
 Punte trequarti a punta ciascun lato, in confezioni da 10 pezzi

für Drähte mit
 for wires with
 para agujas con
 per punte con

KIRSCHNER

6,0 cm / 2 ¹ / ₂ "	10,0 cm / 4"	12,0 cm / 4 ³ / ₄ "	14,0 cm / 4 ³ / ₄ "	16,0 cm / 6 ¹ / ₄ "	31,0 cm / 12 ¹ / ₄ "	
1420-6208	1421-0208	1421-2208	1421-4208	1421-6208	1423-1208	Ø 0,8 mm
1420-6210	1421-0210	1421-2210	1421-4210	1421-6210	1423-1210	Ø 1,0 mm
1420-6212	1421-0212	1421-2212	1421-4212	1421-6212	1423-1212	Ø 1,2 mm
1420-6214	1421-0214	1421-2214	1421-4214	1421-6214	1423-1214	Ø 1,4 mm
1420-6215	1421-0215	1421-2215	1421-4215	1421-6215	1423-1215	Ø 1,5 mm
1420-6216	1421-0216	1421-2216	1421-4216	1421-6216	1423-1216	Ø 1,6 mm
1420-6218	1421-0218	1421-2218	1421-4218	1421-6218	1423-1218	Ø 1,8 mm
1420-6220	1421-0220	1421-2220	1421-4220	1421-6220	1423-1220	Ø 2,0 mm
1420-6222	1421-0222	1421-2222	1421-4222	1421-6222	1423-1222	Ø 2,2 mm
1420-6225	1421-0225	1421-2225	1421-4225	1421-6225	1423-1225	Ø 2,5 mm
1420-6230	1421-0230	1421-2230	1421-4230	1421-6230	1423-1230	Ø 3,0 mm



Bohrdrähte mit Trokarspitze und rundem Schaftende, in Packungen zu 10 Stk.
 Wire drills with trocar point and round shaft end, in packages of 10 pieces
 Agujas con punta trocar y cabo redondo, en paquetes de 10 piezas
 Punte trequarti a punta, estremita rotonda, in confezioni da 10 pezzi

für Drähte mit
 for wires with
 para agujas con
 per punte con

KIRSCHNER

6,0 cm / 2 ¹ / ₂ "	10,0 cm / 4"	12,0 cm / 4 ³ / ₄ "	14,0 cm / 4 ³ / ₄ "	16,0 cm / 6 ¹ / ₄ "	31,0 cm / 12 ¹ / ₄ "	
1420-6108	1421-0108	1421-2108	1421-4108	1421-6108	1423-1108	Ø 0,8 mm
1420-6110	1421-0110	1421-2110	1421-4110	1421-6110	1423-1110	Ø 1,0 mm
1420-6112	1421-0112	1421-2112	1421-4112	1421-6112	1423-1112	Ø 1,2 mm
1420-6114	1421-0114	1421-2114	1421-4114	1421-6114	1423-1114	Ø 1,4 mm
1420-6115	1421-0115	1421-2115	1421-4115	1421-6115	1423-1115	Ø 1,5 mm
1420-6116	1421-0116	1421-2116	1421-4116	1421-6116	1423-1116	Ø 1,6 mm
1420-6118	1421-0118	1421-2118	1421-4118	1421-6118	1423-1118	Ø 1,8 mm
1420-6120	1421-0120	1421-2120	1421-4120	1421-6120	1423-1120	Ø 2,0 mm
1420-6122	1421-0122	1421-2122	1421-4122	1421-6122	1423-1122	Ø 2,2 mm
1420-6125	1421-0125	1421-2125	1421-4125	1421-6125	1423-1125	Ø 2,5 mm
1420-6130	1421-0130	1421-2130	1421-4130	1421-6130	1423-1130	Ø 3,0 mm

- Bohrdrähte mit Trokarspitze und flachem Schaftende, in Packungen zu 10 Stk.
 Wire drills with trocar point and flat shaft end, in packages of 10 pieces
 Aguja con punta trocar y cabo plano, en paquetes de 10 piezas
 Punte trequarti a punta, in confezioni da 10 pezzi



für Drähte mit
for wires with
para agujas con
per punte con

KIRSCHNER

6,0 cm / 2 ¹ / ₂ "	10,0 cm / 4"	12,0 cm / 4 ³ / ₄ "	14,0 cm / 4 ³ / ₄ "	16,0 cm / 6 ¹ / ₄ "	31,0 cm / 12 ¹ / ₄ "	
1420-6308	1421-0308	1421-2308	1421-4308	1421-6308	1423-1308	Ø 0,8 mm
1420-6310	1421-0310	1421-2310	1421-4310	1421-6310	1423-1310	Ø 1,0 mm
1420-6312	1421-0312	1421-2312	1421-4312	1421-6312	1423-1312	Ø 1,2 mm
1420-6314	1421-0314	1421-2314	1421-4314	1421-6314	1423-1314	Ø 1,4 mm
1420-6315	1421-0315	1421-2315	1421-4315	1421-6315	1423-1315	Ø 1,5 mm
1420-6316	1421-0316	1421-2316	1421-4316	1421-6316	1423-1316	Ø 1,6 mm
1420-6318	1421-0318	1421-2318	1421-4318	1421-6318	1423-1318	Ø 1,8 mm
1420-6320	1421-0320	1421-2320	1421-4320	1421-6320	1423-1320	Ø 2,0 mm
1420-6322	1421-0322	1421-2322	1421-4322	1421-6322	1423-1322	Ø 2,2 mm
1420-6325	1421-0325	1421-2325	1421-4325	1421-6325	1423-1325	Ø 2,5 mm
1420-6330	1421-0330	1421-2330	1421-4330	1421-6330	1423-1330	Ø 3,0 mm

□



für Drähte mit
for wires with
para agujas con
per punte con

KIRSCHNER

1421-0408	Ø 0,8 mm	10,0 cm / 4"
1421-0410	Ø 1,0 mm	10,0 cm / 4"
1421-0412	Ø 1,2 mm	10,0 cm / 4"
1421-0414	Ø 1,4 mm	10,0 cm / 4"
1421-0415	Ø 1,5 mm	10,0 cm / 4"
1421-0416	Ø 1,6 mm	10,0 cm / 4"
1421-0418	Ø 1,8 mm	10,0 cm / 4"
1421-0420	Ø 2,0 mm	10,0 cm / 4"
1421-0422	Ø 2,2 mm	10,0 cm / 4"
1421-0425	Ø 2,5 mm	10,0 cm / 4"
1421-0430	Ø 3,0 mm	10,0 cm / 4"

- Bohrdraht mit Lanzettenspitze, flaches Schaftende, in Packungen zu 10 Stk.
 Wire drill with lancet point, flat shaft end, in packages of 10 pieces
 Aguja con punta de lancetta, cabo plano, en paquetes de 10 piezas
 Punta lanceolata a punta, in confezioni da 10 pezzi



mit Metall-Deckel
with metal lid
con tapa metalica
con coperchio metallico

für Drähte mit
for wires with
para agujas con
per punte con

mit Kunststoff-Deckel
with plastic lid
con tapa de plastico
con coperchio in plastico

für Drähte mit
for wires with
para agujas con
per punte con

10,0 cm / 4"	16,0 cm / 6 ¹ / ₄ "	31,0 cm / 12 ¹ / ₄ "		10,0 cm / 4"	16,0 cm / 6 ¹ / ₄ "	31,0 cm / 12 ¹ / ₄ "	
1190-0008	1190-2008	1190-4008	Ø 0,8 mm	1190-1008	1190-3008	1190-5008	Ø 0,8 mm
1190-0010	1190-2010	1190-4010	Ø 1,0 mm	1190-1010	1190-3010	1190-5010	Ø 1,0 mm
1190-0012	1190-2012	1190-4012	Ø 1,2 mm	1190-1012	1190-3012	1190-5012	Ø 1,2 mm
1190-0014	1190-2014	1190-4014	Ø 1,4 mm	1190-1014	1190-3014	1190-5014	Ø 1,4 mm
1190-0015	1190-2015	1190-4015	Ø 1,5 mm	1190-1015	1190-3015	1190-5015	Ø 1,5 mm
1190-0016	1190-2016	1190-4016	Ø 1,6 mm	1190-1016	1190-3016	1190-5016	Ø 1,6 mm
1190-0018	1190-2018	1190-4018	Ø 1,8 mm	1190-1018	1190-3018	1190-5018	Ø 1,8 mm
1190-0020	1190-2020	1190-4020	Ø 2,0 mm	1190-1020	1190-3020	1190-5020	Ø 2,0 mm
1190-0022	1190-2022	1190-4022	Ø 2,2 mm	1190-1022	1190-3022	1190-5022	Ø 2,2 mm
1190-0025	1190-2025	1190-4025	Ø 2,5 mm	1190-1025	1190-3025	1190-5025	Ø 2,5 mm
1190-0030	1190-2030	1190-4030	Ø 3,0 mm	1190-1030	1190-3030	1190-5030	Ø 3,0 mm

Mehrfach-Bohrdrahtspender
Multiple Wire Drill Dispenser
Dispensador multiple para brocas filiformes
Distributore multiplo per punte filiformi

021

- Vier verschiedene Bohrdrähte in einem Spender.
- Eindeutige Kennzeichnung der verschiedenen Durchmesser auf dem Spender.
- Sterilisation und Aufbewahrung im Spender.

- Four different wire drills from one dispenser.
- Clear size markings on the dispenser.
- Sterilization and storage in the dispenser.

- Cuatro agujas distintas en un sólo dispensador.
- El dispensador está marcado claramente con los diferentes diámetros.
- Esterilización y almacejaje dentro del mismo dispensador.

- 4 Differenti punte filiformi e un solo contenitore
- Distributore marcato con i vari diametri.
- Sterilizzazione e conservazione nello stesso distributore.



1420-3900 Ø 1,0 / 1,2 / 1,4 / 1,6 mm x 310 mm
1420-4001 Ø 1,8 / 2,0 / 2,2 / 2,5 mm x 310 mm

1191-2160 Ø 1,0 / 1,2 / 1,4 / 1,6 mm x 160 mm
1191-4160 Ø 1,8 / 2,0 / 2,2 / 2,5 mm x 160 mm



1192-0100 für 10,0 cm Draht / for 10,0 cm wire / para agujas de 10,0 cm / per punte filiformi 10,0 cm
1192-0150 für 15,0 cm Draht / for 15,0 cm wire / para agujas de 15,0 cm / per punte filiformi 15,0 cm

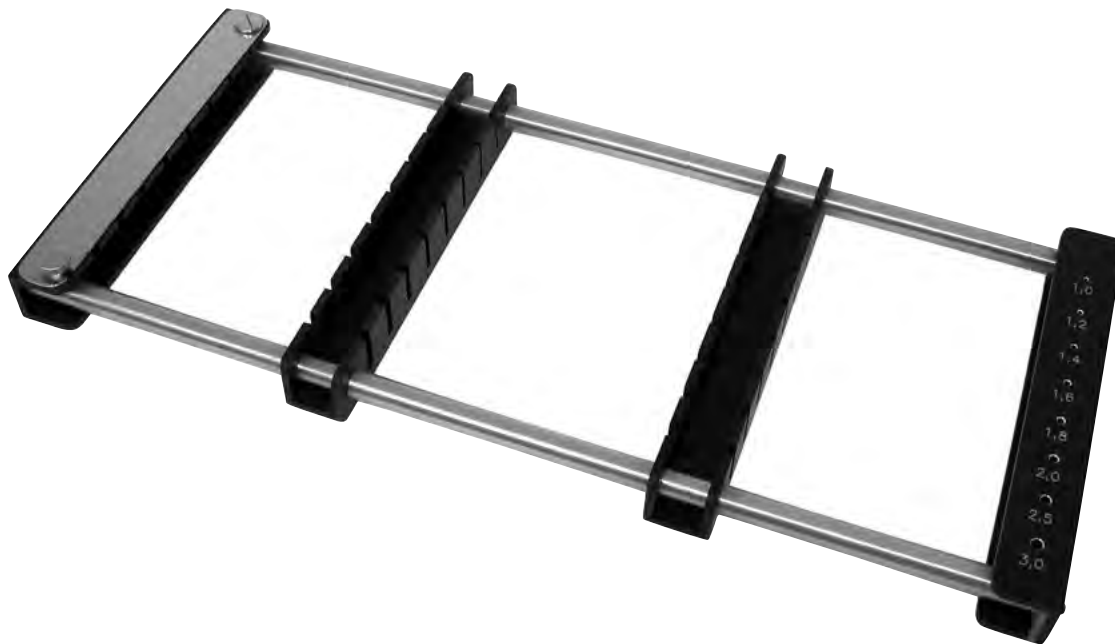

1192-2310 für 31,0 cm Draht / for 31,0 cm wire / para agujas de 31,0 cm / per punte filiformi 31,0 cm

024

**Knochenchirurgie
Bone Surgery
Cirugía ósea
Chirurgia ossea**





1402-6208	8 mm	13,5 cm / 5 ³ / ₈ "
1402-6210	10 mm	13,5 cm / 5 ³ / ₈ "
1402-6212	12 mm	13,5 cm / 5 ³ / ₈ "
1402-6214	14 mm	13,5 cm / 5 ³ / ₈ "
1402-6216	16 mm	13,5 cm / 5 ³ / ₈ "

1402-6308	8 mm	13,5 cm / 5 ³ / ₈ "
1402-6310	10 mm	13,5 cm / 5 ³ / ₈ "
1402-6312	12 mm	13,5 cm / 5 ³ / ₈ "
1402-6314	14 mm	13,5 cm / 5 ³ / ₈ "
1402-6316	16 mm	13,5 cm / 5 ³ / ₈ "

1402-6408	8 mm	13,5 cm / 5 ³ / ₈ "
1402-6410	10 mm	13,5 cm / 5 ³ / ₈ "
1402-6412	12 mm	13,5 cm / 5 ³ / ₈ "
1402-6414	14 mm	13,5 cm / 5 ³ / ₈ "
1402-6416	16 mm	13,5 cm / 5 ³ / ₈ "



PARTSCH

1402-6502	2 mm	13,5 cm / 5 ³ / ₈ "
1402-6503	3 mm	13,5 cm / 5 ³ / ₈ "
1402-6504	4 mm	13,5 cm / 5 ³ / ₈ "
1402-6505	5 mm	13,5 cm / 5 ³ / ₈ "
1402-6506	6 mm	13,5 cm / 5 ³ / ₈ "

PARTSCH

1402-6602	2 mm	17,0 cm / 6 ³ / ₄ "
1402-6603	3 mm	17,0 cm / 6 ³ / ₄ "
1402-6604	4 mm	17,0 cm / 6 ³ / ₄ "
1402-6605	5 mm	17,0 cm / 6 ³ / ₄ "
1402-6606	6 mm	17,0 cm / 6 ³ / ₄ "
1402-6607	7 mm	17,0 cm / 6 ³ / ₄ "

PARTSCH

1402-6702	2 mm	13,5 cm / 5 ³ / ₈ "
1402-6703	3 mm	13,5 cm / 5 ³ / ₈ "
1402-6704	4 mm	13,5 cm / 5 ³ / ₈ "
1402-6705	5 mm	13,5 cm / 5 ³ / ₈ "
1402-6706	6 mm	13,5 cm / 5 ³ / ₈ "

Flachmeißel, Hohlmeißel, Osteotome
 Chiseles, Gouges, Osteotomes
 Cinceles, Gubias, Osteótomos
 Scalpelli, Sgorbie, Osteotomi



PARTSCH

1402-6802	2 mm	17,0 cm / 6 ³ / ₄ "
1402-6803	3 mm	17,0 cm / 6 ³ / ₄ "
1402-6804	4 mm	17,0 cm / 6 ³ / ₄ "
1402-6805	5 mm	17,0 cm / 6 ³ / ₄ "
1402-6806	6 mm	17,0 cm / 6 ³ / ₄ "
1402-6807	7 mm	17,0 cm / 6 ³ / ₄ "



ALEXANDER

1402-7304	4 mm	18,0 cm / 7"
1402-7306	6 mm	18,0 cm / 7"
1402-7308	8 mm	18,0 cm / 7"
1402-7310	10 mm	18,0 cm / 7"
1402-7312	12 mm	18,0 cm / 7"
1402-7314	14 mm	18,0 cm / 7"



ALEXANDER

1402-7404	4 mm	18,0 cm / 7"
1402-7406	6 mm	18,0 cm / 7"
1402-7408	8 mm	18,0 cm / 7"
1402-7410	10 mm	18,0 cm / 7"
1402-7412	12 mm	18,0 cm / 7"
1402-7414	14 mm	18,0 cm / 7"



STILLE

1402-8210	10 mm	20,0 cm / 8"
1402-8215	15 mm	20,0 cm / 8"
1402-8220	20 mm	20,0 cm / 8"
1402-8225	25 mm	20,0 cm / 8"



STILLE

1402-8410	10 mm	20,0 cm / 8"
1402-8415	15 mm	20,0 cm / 8"
1402-8420	20 mm	20,0 cm / 8"
1402-8425	25 mm	20,0 cm / 8"



STILLE

1402-8810	10 mm	20,0 cm / 8"
1402-8815	15 mm	20,0 cm / 8"
1402-8820	20 mm	20,0 cm / 8"
1402-8825	25 mm	20,0 cm / 8"



MINI-LAMBOTTE

1402-7602	2 mm	12,5 cm / 5"
1402-7603	3 mm	12,5 cm / 5"
1402-7604	4 mm	12,5 cm / 5"
1402-7606	6 mm	12,5 cm / 5"
1402-7608	8 mm	12,5 cm / 5"
1402-7610	10 mm	12,5 cm / 5"
1402-7612	12 mm	12,5 cm / 5"
1402-7615	15 mm	12,5 cm / 5"



MINI-LAMBOTTE

1402-7703	3 mm	17,0 cm / 6 ³ / ₄ "
1402-7704	4 mm	17,0 cm / 6 ³ / ₄ "
1402-7706	6 mm	17,0 cm / 6 ³ / ₄ "
1402-7708	8 mm	17,0 cm / 6 ³ / ₄ "
1402-7710	10 mm	17,0 cm / 6 ³ / ₄ "
1402-7712	12 mm	17,0 cm / 6 ³ / ₄ "
1402-7715	15 mm	17,0 cm / 6 ³ / ₄ "

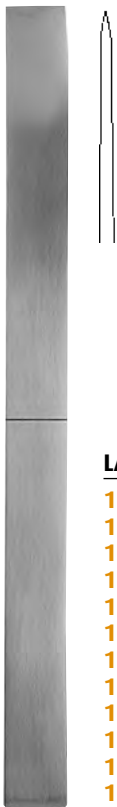

LAMBOTTE

1402-9204	4 mm	24,0 cm / 9 ¹ / ₂ "
1402-9206	6 mm	24,0 cm / 9 ¹ / ₂ "
1402-9208	8 mm	24,0 cm / 9 ¹ / ₂ "
1402-9210	10 mm	24,0 cm / 9 ¹ / ₂ "
1402-9213	12 mm	24,0 cm / 9 ¹ / ₂ "
1402-9215	15 mm	24,0 cm / 9 ¹ / ₂ "
1402-9220	20 mm	24,0 cm / 9 ¹ / ₂ "
1402-9225	25 mm	24,0 cm / 9 ¹ / ₂ "
1402-9230	30 mm	24,0 cm / 9 ¹ / ₂ "
1402-9238	38 mm	24,0 cm / 9 ¹ / ₂ "
1402-9244	44 mm	24,0 cm / 9 ¹ / ₂ "
1402-9250	50 mm	24,0 cm / 9 ¹ / ₂ "

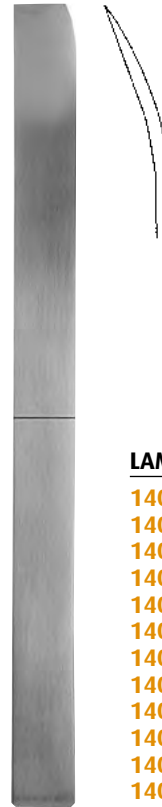

LAMBOTTE

1402-9304	4 mm	24,0 cm / 9 ¹ / ₂ "
1402-9306	6 mm	24,0 cm / 9 ¹ / ₂ "
1402-9308	8 mm	24,0 cm / 9 ¹ / ₂ "
1402-9310	10 mm	24,0 cm / 9 ¹ / ₂ "
1402-9313	12 mm	24,0 cm / 9 ¹ / ₂ "
1402-9315	15 mm	24,0 cm / 9 ¹ / ₂ "
1402-9320	20 mm	24,0 cm / 9 ¹ / ₂ "
1402-9325	25 mm	24,0 cm / 9 ¹ / ₂ "
1402-9330	30 mm	24,0 cm / 9 ¹ / ₂ "
1402-9338	38 mm	24,0 cm / 9 ¹ / ₂ "
1402-9344	44 mm	24,0 cm / 9 ¹ / ₂ "
1402-9350	50 mm	24,0 cm / 9 ¹ / ₂ "



SMITH-PETERSON

1403-0606	6 mm	20,0 cm / 8"
1403-0609	9 mm	20,0 cm / 8"
1403-0613	13 mm	20,0 cm / 8"
1403-0616	16 mm	20,0 cm / 8"
1403-0619	19 mm	20,0 cm / 8"
1403-0625	25 mm	20,0 cm / 8"
1403-0632	32 mm	20,0 cm / 8"



SMITH-PETERSON

1403-0706	6 mm	20,0 cm / 8"
1403-0709	9 mm	20,0 cm / 8"
1403-0713	13 mm	20,0 cm / 8"
1403-0716	16 mm	20,0 cm / 8"
1403-0719	19 mm	20,0 cm / 8"
1403-0725	25 mm	20,0 cm / 8"
1403-0732	32 mm	20,0 cm / 8"



SMITH-PETERSON

1403-0809	9 mm	20,0 cm / 8"
1403-0813	14 mm	20,0 cm / 8"
1403-0819	19 mm	20,0 cm / 8"
1403-0825	25 mm	20,0 cm / 8"



SMITH-PETERSON

1403-0909	9 mm	20,0 cm / 8"
1403-0913	14 mm	20,0 cm / 8"
1403-0919	19 mm	20,0 cm / 8"
1403-0925	25 mm	20,0 cm / 8"



HOKE

1402-9803	3 mm	17,0 cm / 6 ³ / ₄ "
1402-9805	5 mm	17,0 cm / 6 ³ / ₄ "
1402-9806	6 mm	17,0 cm / 6 ³ / ₄ "
1402-9808	8 mm	17,0 cm / 6 ³ / ₄ "
1402-9809	9 mm	17,0 cm / 6 ³ / ₄ "



HIBBS

1403-0006	6 mm	24,0 cm / 9 ¹ / ₂ "
1403-0013	13 mm	24,0 cm / 9 ¹ / ₂ "
1403-0019	19 mm	24,0 cm / 9 ¹ / ₂ "
1403-0025	25 mm	24,0 cm / 9 ¹ / ₂ "
1403-0032	32 mm	24,0 cm / 9 ¹ / ₂ "

Flachmeißel, Hohlmeißel, Osteotome
 Chiseles, Gouges, Osteotomes
 Cinceles, Gubias, Osteótomos
 Scalpelli, Sgorbie, Osteotomi



HIBBS

1403-0206	6 mm	24,0 cm / 9 1/2"
1403-0213	13 mm	24,0 cm / 9 1/2"
1403-0219	19 mm	24,0 cm / 9 1/2"
1403-0225	25 mm	24,0 cm / 9 1/2"
1403-0232	32 mm	24,0 cm / 9 1/2"



HIBBS

1403-0106	6 mm	24,0 cm / 9 1/2"
1403-0113	13 mm	24,0 cm / 9 1/2"
1403-0119	19 mm	24,0 cm / 9 1/2"
1403-0125	25 mm	24,0 cm / 9 1/2"
1403-0132	32 mm	24,0 cm / 9 1/2"



HIBBS

1403-0406	6 mm	24,0 cm / 9 1/2"
1403-0413	13 mm	24,0 cm / 9 1/2"
1403-0419	19 mm	24,0 cm / 9 1/2"
1403-0425	25 mm	24,0 cm / 9 1/2"
1403-0432	32 mm	24,0 cm / 9 1/2"



HIBBS

1403-0306	6 mm	24,0 cm / 9 1/2"
1403-0313	13 mm	24,0 cm / 9 1/2"
1403-0319	19 mm	24,0 cm / 9 1/2"
1403-0325	25 mm	24,0 cm / 9 1/2"
1403-0332	32 mm	24,0 cm / 9 1/2"



1402-5102 ø 2 mm

●
1402-5103 ø 3 mm

●
1402-5104 ø 4 mm

●
1402-5105 ø 5 mm

●
1402-5106 ø 6 mm

●
1402-5108 ø 8 mm

●
1402-5110 ø 10 mm

1402-5102 – 1402-5110 16,0 cm / 6 1/4"



1402-5203 ø 3 mm

●
1402-5205 ø 5 mm

●
1402-5208 ø 8 mm

●
1402-5212 ø 12 mm

●
1402-5214 ø 14 mm

●
1402-5216 ø 16 mm

1402-5203 – 1402-5216 20,0 cm / 8"

Flachmeißel, Hohlmeißel und Osteotome mit Ferrozellgriff
Chisels, Gouges and Osteotomes with handle from artificial wood
Cinceles, Gubias y Osteótomos con mango de madera artificial
Scalpelli, Sgorbie e Osteotomi con manico in legno artificiale



1403-1000 18,0 cm / 7"



1403-1080

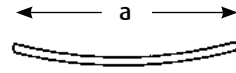

Hohlmeißel
 Gouges
 Gubias
 Sgorbie

1403-1009 a = 50 mm
 1403-1010 a = 60 mm
 1403-1010 a = 70 mm

Flachmeißel
 Chisels
 Cinceles
 Scalpelli

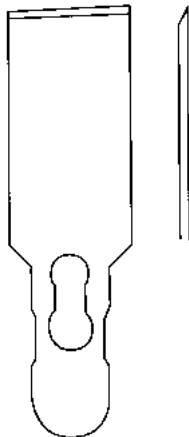

1403-1001 5,0 mm
 1403-1002 10,0 mm
 1403-1003 16,0 mm
 1403-1004 25,0 mm

Osteotome
 Chisels
 Cinceles
 Scalpelli

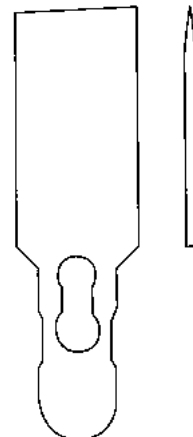

1403-1005 5,0 mm
 1403-1006 10,0 mm
 1403-1007 16,0 mm
 1403-1008 25,0 mm



Osteotome
Chisels
Cinceles
Scalpelli

MINI-LEXER

1403-1604	4 mm	18,0 cm / 7"
1403-1606	6 mm	18,0 cm / 7"
1403-1608	8 mm	18,0 cm / 7"
1403-1610	10 mm	18,0 cm / 7"
1403-1612	12 mm	18,0 cm / 7"



Hohlmeißel
Gouges
Gubias
Sgorbie

MINI-LEXER

1403-1804	4 mm	18,0 cm / 7"
1403-1806	6 mm	18,0 cm / 7"
1403-1808	8 mm	18,0 cm / 7"
1403-1810	10 mm	18,0 cm / 7"
1403-1812	12 mm	18,0 cm / 7"



Hohlmeißel
Gouges
Gubias
Sgorbie

LEXER

1403-2605	5 mm	25,0 cm / 9 ³ / ₄ "
1403-2610	10 mm	25,0 cm / 9 ³ / ₄ "
1403-2615	15 mm	25,0 cm / 9 ³ / ₄ "



Hohlmeißel
Gouges
Gubias
Sgorbie

LEXER

1403-2705	5 mm	25,0 cm / 9 ³ / ₄ "
1403-2710	10 mm	25,0 cm / 9 ³ / ₄ "
1403-2715	15 mm	25,0 cm / 9 ³ / ₄ "

Flachmeißel, Hohlmeißel und Osteotome mit Ferrozellgriff
Chisels, Gouges and Osteotomes with handle from artificial wood
Cinceles, Gubias y Osteótomos con mango de madera artificial
Scalpelli, Sgorbie e Osteotomi con manico in legno artificiale



Osteotome
Chisels
Cinceles
Scalpelli

LEXER

1403-2005	5 mm	22,0 cm / 8 ³ / ₄ "
1403-2007	7 mm	22,0 cm / 8 ³ / ₄ "
1403-2010	10 mm	22,0 cm / 8 ³ / ₄ "
1403-2015	15 mm	22,0 cm / 8 ³ / ₄ "
1403-2020	20 mm	22,0 cm / 8 ³ / ₄ "
1403-2025	25 mm	22,0 cm / 8 ³ / ₄ "
1403-2030	30 mm	22,0 cm / 8 ³ / ₄ "



Hohlmeißel
Gouges
Gubias
Sgorbie

LEXER

1403-2205	5 mm	22,0 cm / 8 ³ / ₄ "
1403-2207	7 mm	22,0 cm / 8 ³ / ₄ "
1403-2210	10 mm	22,0 cm / 8 ³ / ₄ "
1403-2212	15 mm	22,0 cm / 8 ³ / ₄ "
1403-2220	20 mm	22,0 cm / 8 ³ / ₄ "
1403-2225	25 mm	22,0 cm / 8 ³ / ₄ "
1403-2230	30 mm	22,0 cm / 8 ³ / ₄ "



Hohlmeißel
Gouges
Gubias
Sgorbie

LEXER

1403-3407	7 mm	28,5 cm / 11 ¹ / ₄ "
1403-3410	10 mm	28,5 cm / 11 ¹ / ₄ "



Osteotome
Chisels
Cinceles
Scalpelli

LEXER

1403-3110	10 mm	27,5 cm / 10 ³ / ₄ "
1403-3115	15 mm	27,5 cm / 10 ³ / ₄ "



Hohlmeißel
 Gouges
 Gubias
 Sgorbie

LEXER

1403-3310	10 mm	27,5 cm / 10 ³ / ₄ "
1403-3315	15 mm	27,5 cm / 10 ³ / ₄ "



Hohlmeißel
 Gouges
 Gubias
 Sgorbie

ZIELKE

1403-2555	5,5 mm	23,0 cm / 9"
1403-2590	9,0 mm	23,0 cm / 9"



Flachmeißel
 Chisels
 Cinceles
 Scalpelli

1403-2810	10 mm	16,0 cm / 6 ¹ / ₄ "
1403-2815	15 mm	16,0 cm / 6 ¹ / ₄ "



Flachmeißel
 Chisels
 Cinceles
 Scalpelli

1403-2910	10 mm	20,0 cm / 8"
1403-2915	15 mm	20,0 cm / 8"
1403-2920	20 mm	20,0 cm / 8"

Flachmeißel, Hohlmeißel und Osteotome mit Ferrozellgriff
Chisels, Gouges and Osteotomes with handle from artificial wood
Cinceles, Gubias y Osteótomos con mango de madera artificial
Scalpelli, Sgorbie e Osteotomi con manico in legno artificiale



Flachmeißel
Chisels
Cinceles
Scalpelli

-
- 1403-3010 10,0 mm 20,0 cm / 8"
 - 1403-3015 15,0 mm 20,0 cm / 8"
 - 1403-3020 20,0 mm 20,0 cm / 8"



Flachmeißel
Chisels
Cinceles
Scalpelli

-
- 1403-2820 20,0 mm 24,5 cm / 9³/₄"



Flachmeißel
Chisels
Cinceles
Scalpelli

-
- 1403-2916 16,0 mm 26,5 cm / 10¹/₂"



Hohlmeißel
Gouges
Gubias
Sgorbie

-
- 1403-3022 9,0 mm 22,0 cm / 8³/₄"



Hohlmeißel
 Gouge
 Gubia
 Sgorbie

COBB

1403-4101 8,0 mm 27,5 cm / 10³/₄"



Hohlmeißel
 Gouge
 Gubia
 Sgorbie

COBB

1403-4102 8,0 mm 27,0 cm / 10³/₄"



Hohlmeißel
 Gouge
 Gubia
 Sgorbie

COBB

1403-4104 8,0 mm 27,0 cm / 10³/₄"

Hohlmeißel und Osteotome mit Ferrozellgriff
Gouges and Osteotomes with handle from artificial wood
Gubias y Osteótomos con mango de madera artificial
Sgorbie e Osteotomi con manico in legno artificiale

024



DAHMEN

1403-5004	4 mm	30,0 cm / 11 ³ / ₄ "
1403-5005	5 mm	30,0 cm / 11 ³ / ₄ "
1403-5006	6 mm	30,0 cm / 11 ³ / ₄ "
1403-5008	8 mm	30,0 cm / 11 ³ / ₄ "
1403-5010	10 mm	30,0 cm / 11 ³ / ₄ "
1403-5012	12 mm	30,0 cm / 11 ³ / ₄ "
1403-5015	15 mm	30,0 cm / 11 ³ / ₄ "
1403-5020	20 mm	30,0 cm / 11 ³ / ₄ "
1403-5022	22 mm	30,0 cm / 11 ³ / ₄ "
1403-5025	25 mm	30,0 cm / 11 ³ / ₄ "

DAHMEN

1403-5104	4 mm	30,0 cm / 11 ³ / ₄ "
1403-5105	5 mm	30,0 cm / 11 ³ / ₄ "
1403-5106	6 mm	30,0 cm / 11 ³ / ₄ "
1403-5108	8 mm	30,0 cm / 11 ³ / ₄ "
1403-5110	10 mm	30,0 cm / 11 ³ / ₄ "
1403-5112	12 mm	30,0 cm / 11 ³ / ₄ "
1403-5115	15 mm	30,0 cm / 11 ³ / ₄ "
1403-5120	20 mm	30,0 cm / 11 ³ / ₄ "
1403-5122	22 mm	30,0 cm / 11 ³ / ₄ "
1403-5125	25 mm	30,0 cm / 11 ³ / ₄ "

**DAHMEN**

1403-5204	4 mm	30,0 cm / 11 ³ / ₄ "
1403-5205	5 mm	30,0 cm / 11 ³ / ₄ "
1403-5206	6 mm	30,0 cm / 11 ³ / ₄ "
1403-5208	8 mm	30,0 cm / 11 ³ / ₄ "
1403-5210	10 mm	30,0 cm / 11 ³ / ₄ "
1403-5212	12 mm	30,0 cm / 11 ³ / ₄ "
1403-5215	15 mm	30,0 cm / 11 ³ / ₄ "
1403-5220	20 mm	30,0 cm / 11 ³ / ₄ "
1403-5222	22 mm	30,0 cm / 11 ³ / ₄ "
1403-5225	25 mm	30,0 cm / 11 ³ / ₄ "

DAHMEN

1403-5304	4 mm	30,0 cm / 11 ³ / ₄ "
1403-5305	5 mm	30,0 cm / 11 ³ / ₄ "
1403-5306	6 mm	30,0 cm / 11 ³ / ₄ "
1403-5308	8 mm	30,0 cm / 11 ³ / ₄ "
1403-5310	10 mm	30,0 cm / 11 ³ / ₄ "
1403-5312	12 mm	30,0 cm / 11 ³ / ₄ "
1403-5315	15 mm	30,0 cm / 11 ³ / ₄ "
1403-5320	20 mm	30,0 cm / 11 ³ / ₄ "
1403-5322	22 mm	30,0 cm / 11 ³ / ₄ "
1403-5325	25 mm	30,0 cm / 11 ³ / ₄ "



WILLIGER

1402-1526	300 g	ø 26 mm	24,0 cm / 9 ¹ / ₂ "
1402-1528	340 g	ø 28 mm	24,0 cm / 9 ¹ / ₂ "
1402-1530	400 g	ø 30 mm	24,0 cm / 9 ¹ / ₂ "



DOYEN

1402-1625	120 g	ø 25 mm	19,5 cm / 7 ³ / ₄ "
1402-1630	180 g	ø 30 mm	19,5 cm / 7 ³ / ₄ "
1402-1635	260 g	ø 35 mm	21,0 cm / 8 ¹ / ₄ "

**COLLIN**

1402-1730 220 g ø 30 mm 20,0 cm / 8"

**LUCAE**

1402-1819 230 g ø 19 mm 19,5 cm / 7³/₄"
1402-1825 260 g ø 25 mm 19,5 cm / 7³/₄"



COTTLE

1402-0230 350 g ø 30 mm 19,0 cm / 7½"



WILLIGER

1402-0322 140 g ø 20 mm 16,5 cm / 6½"



mit auswechsel-
baren Backen
(1402-0022)
with inter-
changeable disks
(1402-0022)
con tapas
intercambiables
(1402-0022)
con piastre
intercambiabili
(1402-0022)

MEAD

1402-2020 320 g ø 26 mm 19,0 cm / 7½"



PARTSCH

1402-0422 200 g ø 22 mm 19,0 cm / 7½"

**HAJEK**

1402-0527 200 g ø 27 mm 20,0 cm / 8"

**GERZOG**

1402-2001 270 g ø 25 mm 19,5 cm / 7 1/2"

**KIRK**

1402-2002 650 g ø 38 mm 21,0 cm / 8 1/4"

**BERGMANN**

1402-1145 490 g ø 45 mm 25,0 cm / 9 3/4"



BERGMANN

1402-1130 400 g ø 30 mm 24,5 cm / 9²/₃"



OMBREDANNE

1402-1340 700 g ø 40 mm 24,0 cm / 9¹/₂"



HEATH

1402-1440 700 g ø 40 mm 18,5 cm / 7¹/₄"

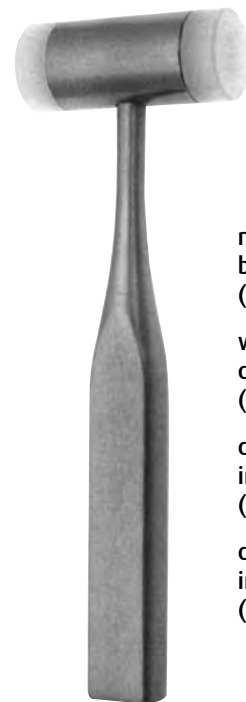

mit auswechsel-
baren Backen
(1402-1259)

with inter-
changeable disks
(1402-1259)

con tapas
intercambiables
(1402-1259)

con piastre
intercambiabili
(1402-1259)

1402-1258 240 g ø 25 mm 18,5 cm / 7¹/₄"



aus Ferrozell
from artificial wood
de madera artificial
in legno artificiale



KIRK

1402-1035	180 g	ø 35 mm	26,0 cm / 10 ¹ / ₄ "
1402-1042	250 g	ø 42 mm	26,0 cm / 10 ¹ / ₄ "
1402-1050	350 g	ø 50 mm	26,0 cm / 10 ¹ / ₄ "

1402-2642	340 g	ø 42 mm	26,0 cm / 10 ¹ / ₄ "
------------------	-------	---------	--------------------------------------------



1402-2929	675 g	ø 30 mm	26,5 cm / 10 ¹ / ₂ "
------------------	-------	---------	--------------------------------------------



1402-2842	530 g	ø 42/30 mm	26,0 cm / 10 ¹ / ₄ "
------------------	-------	------------	--------------------------------------------



1402-3148 480 g ø 30 mm 24,0 cm / 9¹/₂"



1402-3242

Ersatzbacken (Paar) Kunststoff
Spare Facings (pair) plastic
Tapas de repuesto (par) plástico
Placche di ricambio (paio) plastica

1402-3237 370 g ø 37 mm 24,0 cm / 9¹/₂"



1402-3045 450 g ø 30 mm 26,5 cm / 10¹/₂"



1402-3090 900 g ø 50 mm 26,5 cm / 10¹/₂"



Fig. 0000
1404-7901

Fig. 000
1404-7902

Fig. 00
1404-7903

Fig. 0
1404-7904

Fig. 1
1404-7905

Fig. 2
1404-7906

Fig. 3
1404-7907

Fig. 4
1404-7908

Fig. 5
1404-7909

Fig. 6
1404-7910

VOLKMANN
1404-7901 - 1404-7910 17,5 cm / 7"



Fig. 0000
1404-8000

Fig. 000
1404-8001

Fig. 00
1404-8002

Fig. 0
1404-8003

Fig. 1
1404-8004

Fig. 2
1404-8005

Fig. 3
1404-8006

Fig. 4
1404-8007

Fig. 5
1404-8008

Fig. 6
1404-8009

VOLKMANN
1404-8000 - 1404-8009 28,0 cm / 11"

Scharfe Löffel
 Bone Currettes
 Cucharillas cortantes
 Curette per ossa



Fig. 000
 1404-6604

Fig. 1
 1404-6605

Fig. 00
 1404-6603

Fig. 2
 1404-6606

Fig. 0
 1404-6602

Fig. 3
 1404-6607

Fig. 4
 1404-6608

SCHUDE

1404-6605 - 1404-6602

17,0 cm / 6³/₄"



Fig. 0000
 1404-6701

Fig. 0
 1404-6704

Fig. 3
 1404-6707

Fig. 000
 1404-6702

Fig. 1
 1404-6705

Fig. 4
 1404-6708

Fig. 00
 1404-6703

Fig. 2
 1404-6706

Fig. 5
 1404-6709

Fig. 6
 1404-6710

VOLKMANN

1404-6701 - 1404-6710

17,0 cm / 6³/₄"

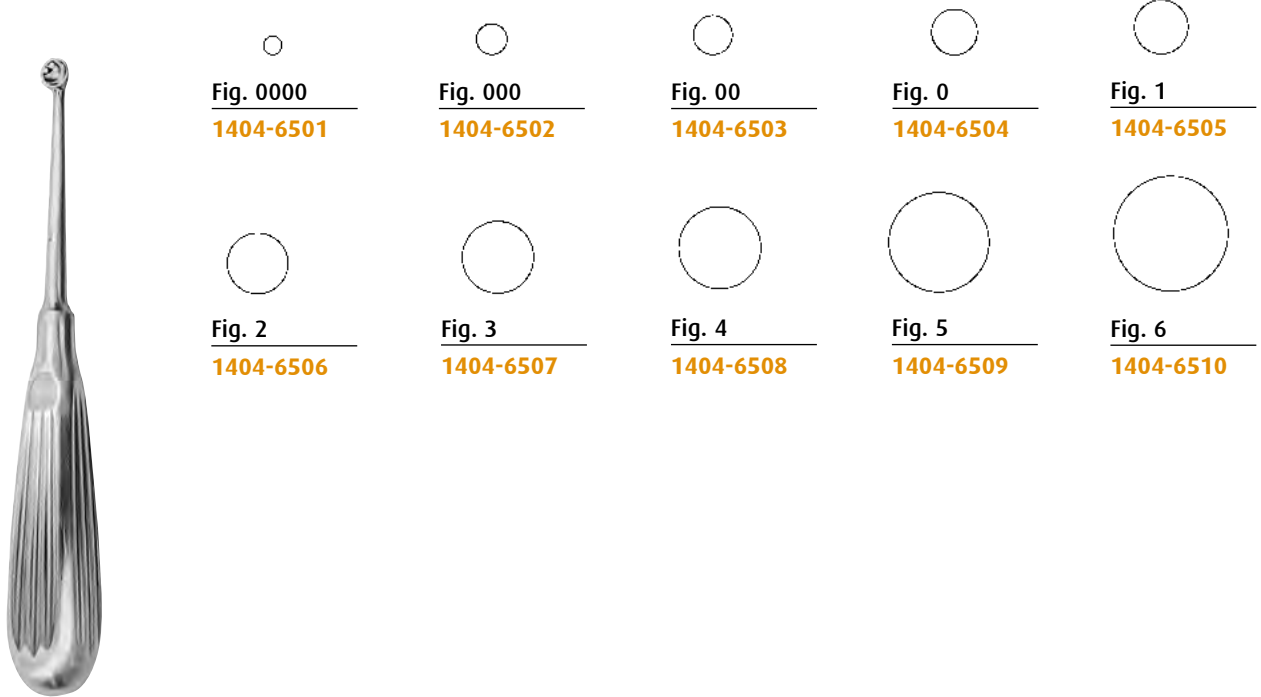

Fig. 0000
1404-6501

Fig. 000
1404-6502

Fig. 00
1404-6503

Fig. 0
1404-6504

Fig. 1
1404-6505

Fig. 2
1404-6506

Fig. 3
1404-6507

Fig. 4
1404-6508

Fig. 5
1404-6509

Fig. 6
1404-6510

BRUNS

1404-6505 - 1404-6501 17,0 cm / 6³/₄"

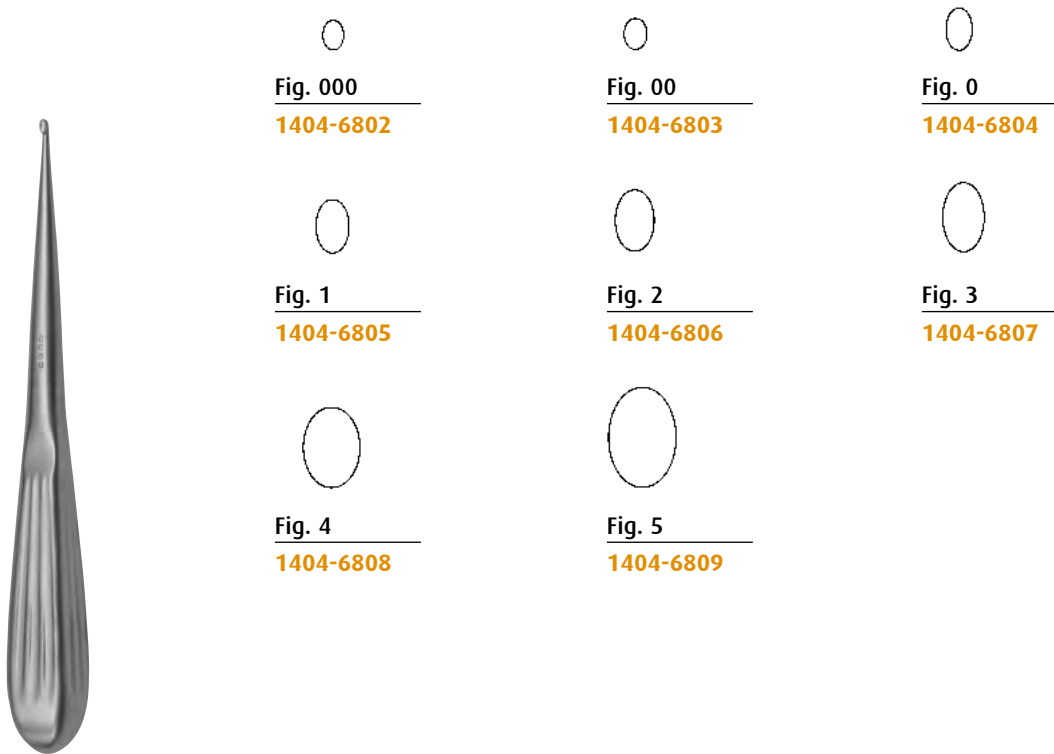

Fig. 000
1404-6802

Fig. 00
1404-6803

Fig. 0
1404-6804

Fig. 1
1404-6805

Fig. 2
1404-6806

Fig. 3
1404-6807

Fig. 4
1404-6808

Fig. 5
1404-6809

SPRATT

1404-6805 - 1404-6802 17,0 cm / 6³/₄"

Scharfe Löffel
 Bone Curettes
 Cucharillas cortantes
 Curette per ossa



Fig. 000
 1404-8212

Fig. 00
 1404-8213

Fig. 0
 1404-8214

Fig. 1
 1404-8215

Fig. 2
 1404-8216

Fig. 3
 1404-8217

Fig. 4
 1404-8218

Fig. 5
 1404-8219

Fig. 6
 1404-8220

BRUNS

1404-8212 - 1404-8220 23,0 cm / 9"



SCOVILLE

1404-8101 25,0 cm / 9³/₄"



SCOVILLE

1404-8102 25,0 cm / 9³/₄"



SCOVILLE

1404-8103 25,0 cm / 9³/₄"

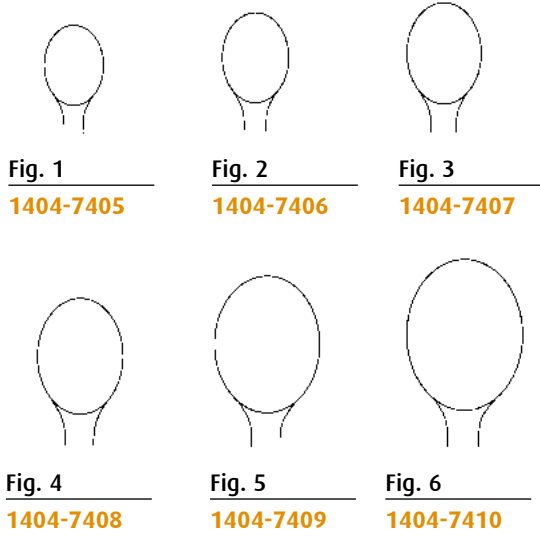

SIMON

1404-7405 - 1404-7410 25,0 cm / 9³/₄"

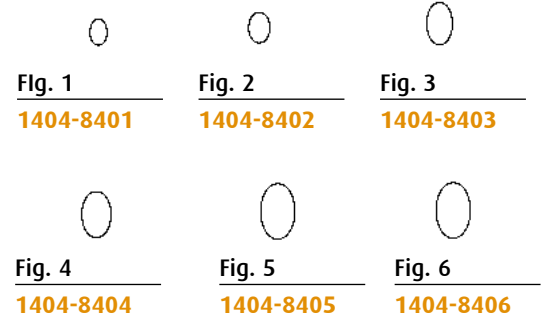

MOD. USA

1404-8401 - 1404-8406 16,0 cm / 6¹/₄"

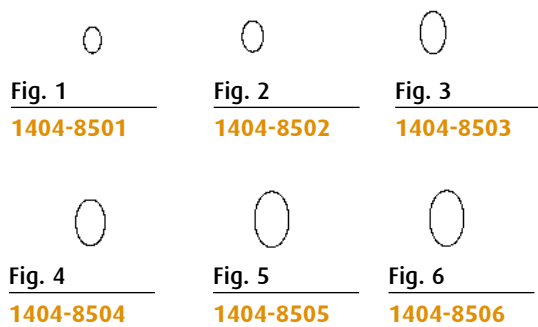

MOD. USA

1404-8501 - 1404-8506 15,5 cm / 6"

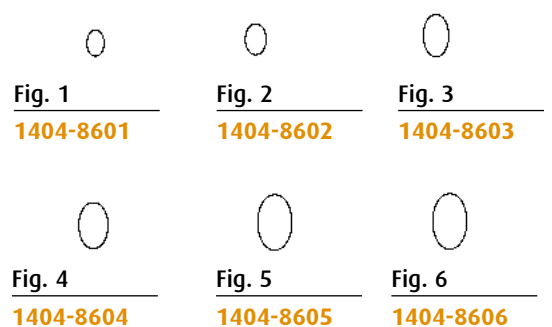

MOD. USA

1404-8601 - 1404-8606 15,5 cm / 6"

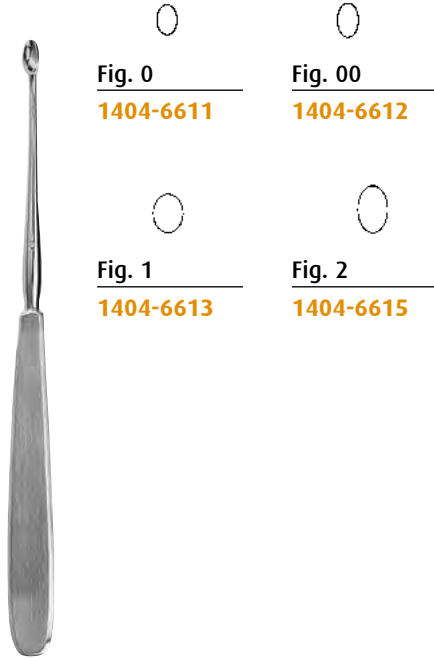

Fig. 0
 1404-6611

Fig. 00
 1404-6612

Fig. 1
 1404-6613

Fig. 2
 1404-6615

WILLIGER
 1404-6611 - 1404-6615 17,0 cm / 6³/₄"

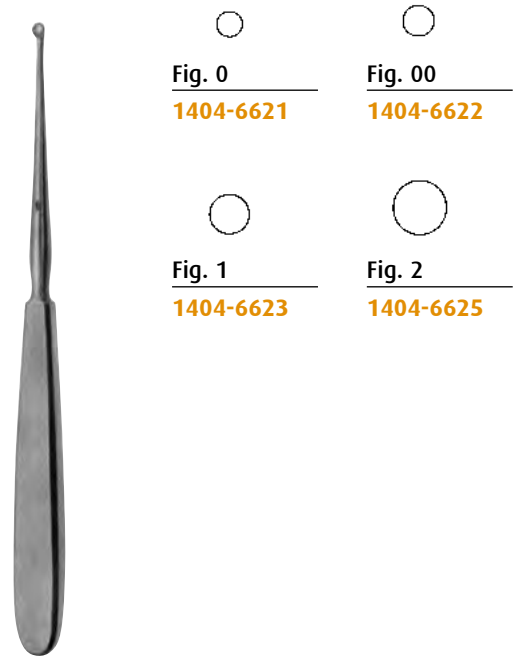

Fig. 0
 1404-6621

Fig. 00
 1404-6622

Fig. 1
 1404-6623

Fig. 2
 1404-6625

WILLIGER
 1404-6621 - 1404-6625 17,5 cm / 7"

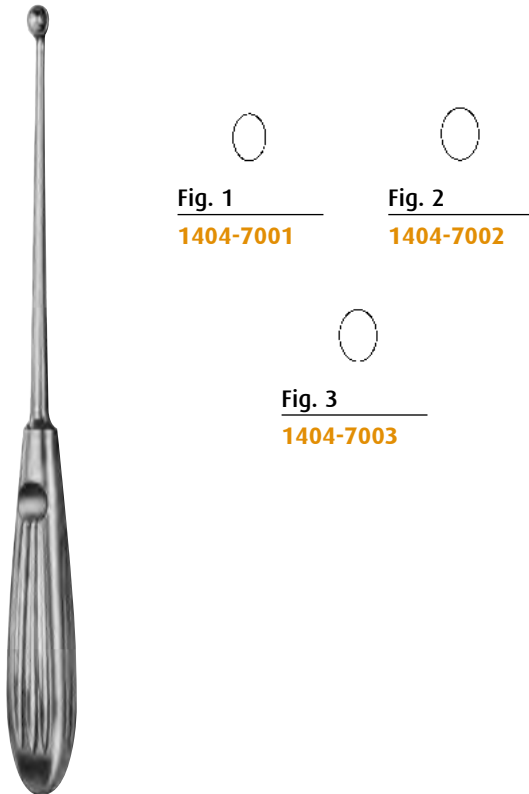
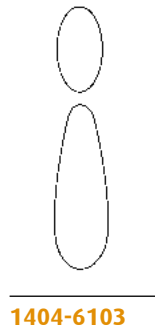
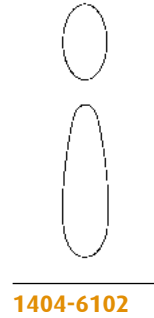
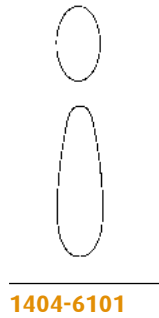

Fig. 1
 1404-7001

Fig. 2
 1404-7002

Fig. 3
 1404-7003

HALLE
 1404-7001 - 1404-7003 21,0 cm / 8¹/₄"



VOLKMANN

- 1404-6101 13,0 cm / 5"
- 1404-6102 14,0 cm / 5 1/2"
- 1404-6103 17,0 cm / 6 3/4"

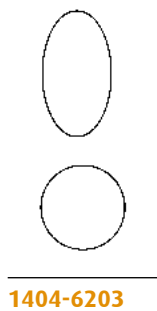
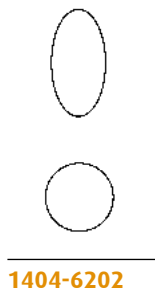
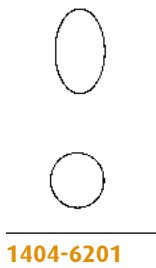

VOLKMANN

- 1404-6201 13,0 cm / 5"
- 1404-6202 16,0 cm / 6 1/4"
- 1404-6203 20,0 cm / 8"

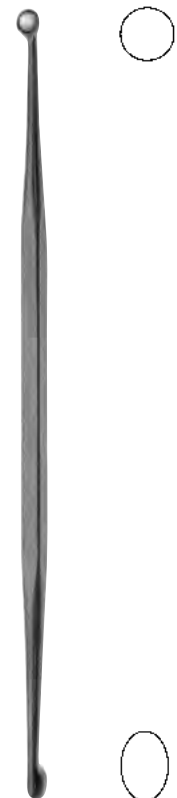

- 1404-6007 21,0 cm / 8 1/4"

Scharfe Löffel
 Bone Curettes
 Cucharillas cortantes
 Curette per ossa



Fig. 00/0

1404-6401



Fig. 0/1

1404-6402



Fig. 1/2

1404-6403

WILLIGER

1404-6401 - 1404-6403

13,5 cm / 5¹/₄"



Fig. 00/00

1404-6410



Fig. 0/1

1404-6411



Fig. 1/2

1404-6412

WILLIGER

1404-6410 - 1404-6412

16,0 cm / 6¹/₄"



Fig. 00/0

1404-6001



Fig. 0/1

1404-6002



Fig. 1/2

1404-6003

MARTINI

1404-6001 - 1404-6003

13,5 cm / 5¹/₄"



Fig. 1 R/L

1404-6306



Fig. 2 R/L

1404-6307



Fig. 3 R/L

1404-6308



HEMMINGWAY

1404-6306 - 1404-6308

18,0 cm / 7"

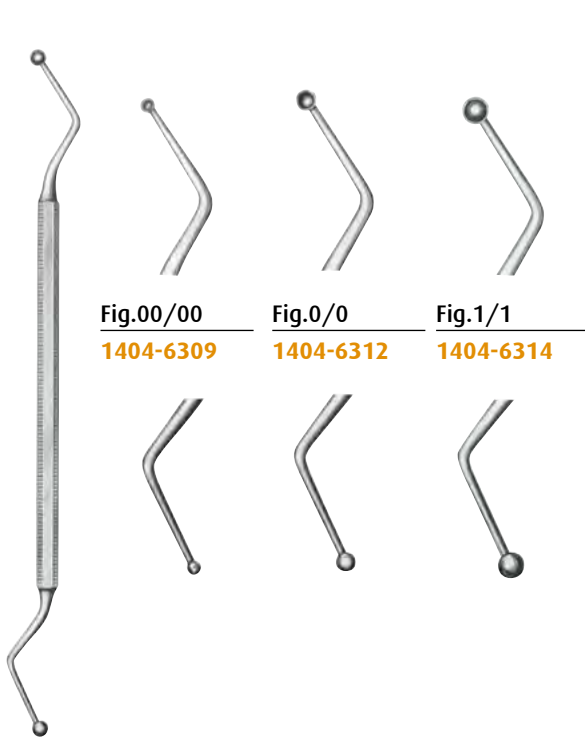

Fig.00/00
1404-6309

Fig.0/0
1404-6312

Fig.1/1
1404-6314

HEMMINGWAY

1404-6309 - 1404-6314

18,0 cm / 7"

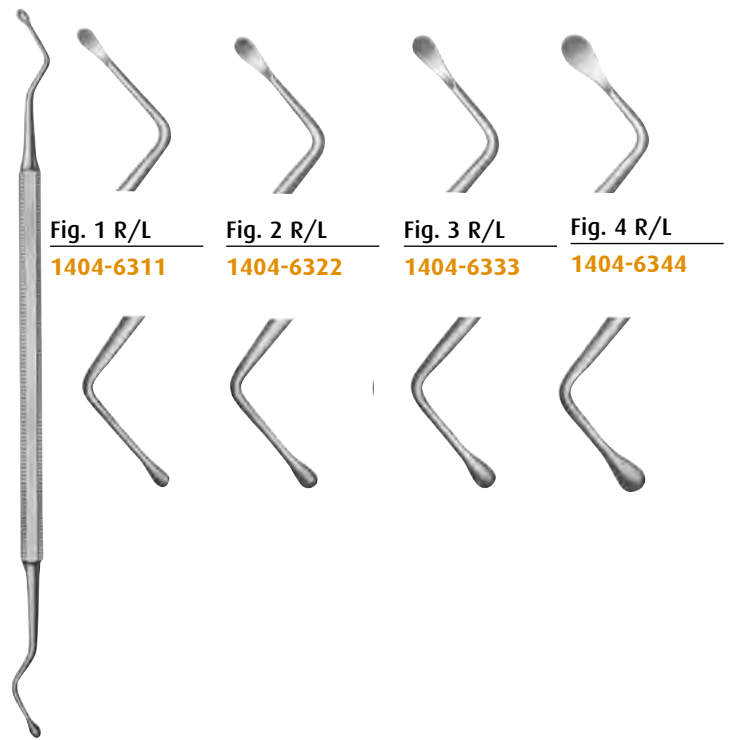

Fig. 1 R/L
1404-6311

Fig. 2 R/L
1404-6322

Fig. 3 R/L
1404-6333

Fig. 4 R/L
1404-6344

HEMMINGWAY

1404-6311 - 1404-6344

18,0 cm / 7"

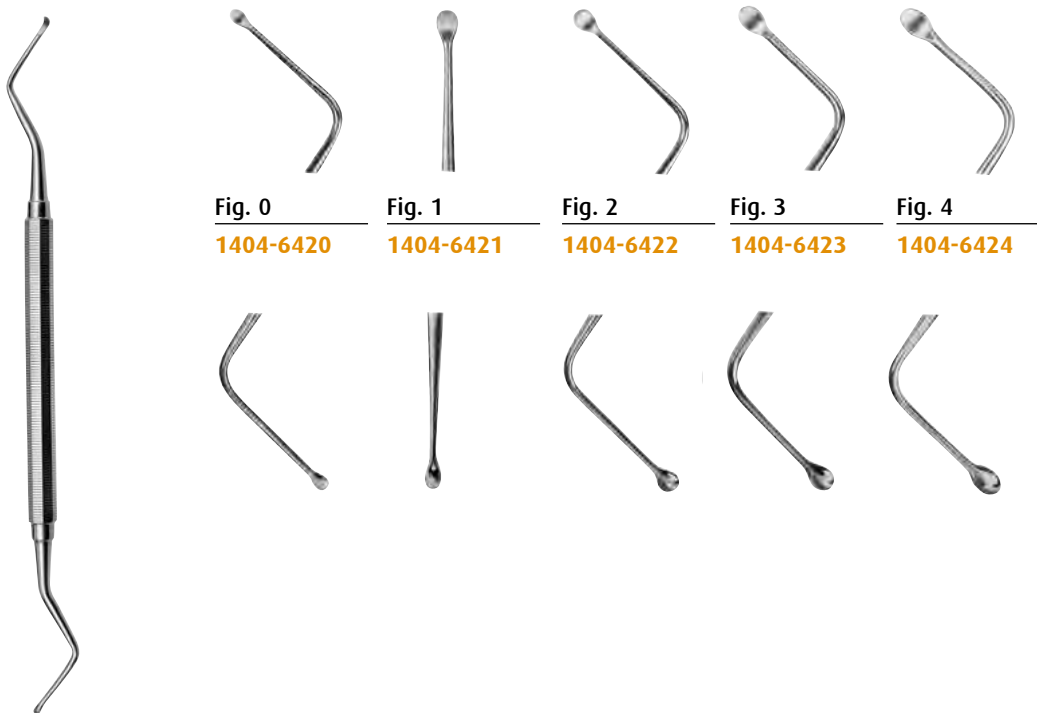

Fig. 0
1404-6420

Fig. 1
1404-6421

Fig. 2
1404-6422

Fig. 3
1404-6423

Fig. 4
1404-6424

MILLER-COLBURN

1404-6420 - 1404-6424

17,0 cm / 6³/₄"

Raspatorien mit Ferrozellgriff
Raspatories with handle from artificial wood
Periostótomos con mango de madera artificial
Periostotomi con manico in legno artificiale

024



1403-9102 20,0 cm / 8"



1403-9103 19,0 cm / 7 1/2"

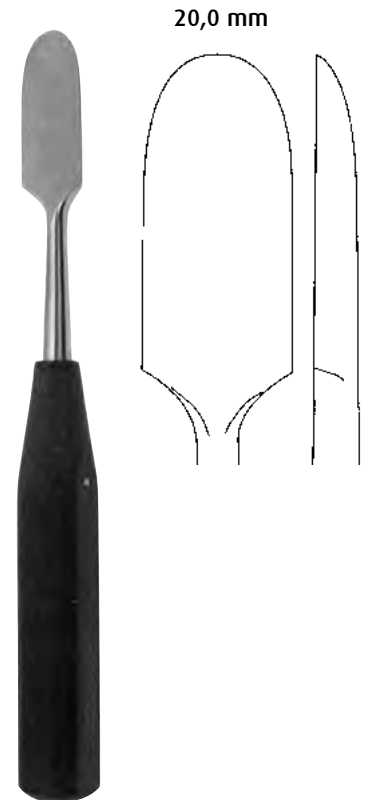

1403-9104 20,0 cm / 8"



1403-9101 19,0 cm / 7 1/2"



1403-9001 18,0 cm / 7"



1403-9002 18,0 cm / 7"



1403-9003 18,0 cm / 7"



1403-9004 18,0 cm / 7"

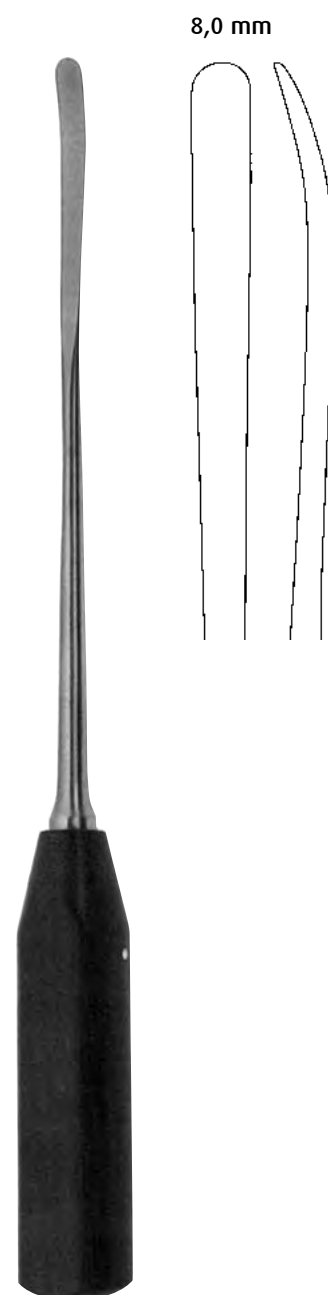

WAGNER
 1403-3609 33,0 cm / 13"

Raspatorien mit Ferrozellgriff
Raspatories with handle from artificial wood
Periostótomos con mango de madera artificial
Periostotomi con manico in legno artificiale

024

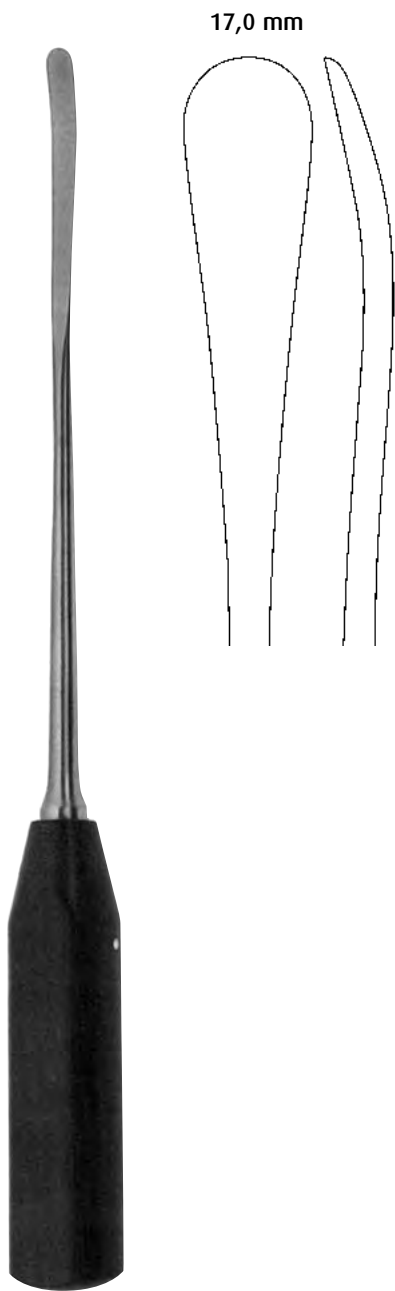

WAGNER

1404-1602 33,0 cm / 13"

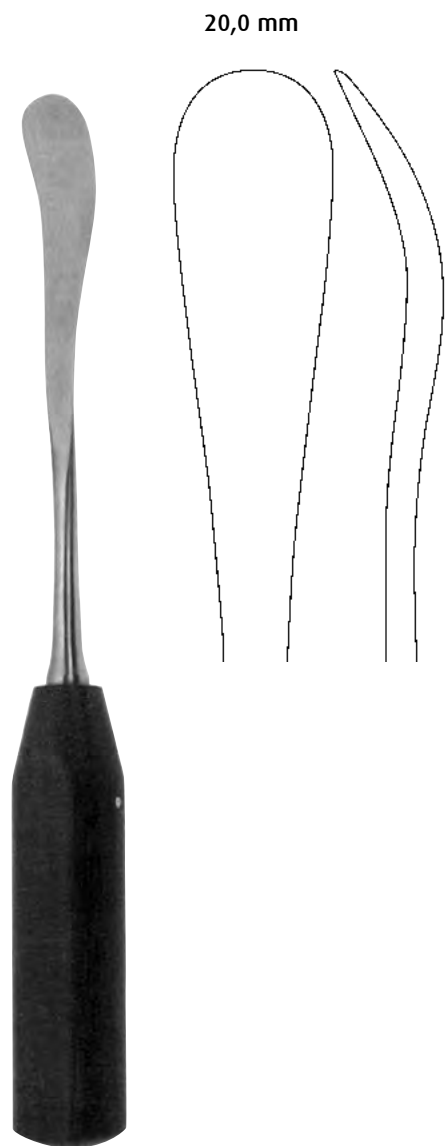

1404-1527 27,5 cm / 10³/₄"



1404-1910 10,0 mm



1404-1801 10,0 mm

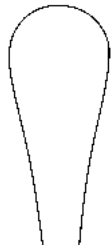

1404-1913 13,0 mm



1404-1802 13,0 mm

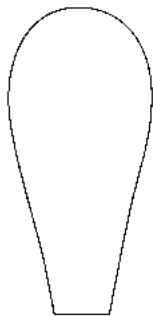

1404-1919 19,0 mm



1404-1803 19,0 mm

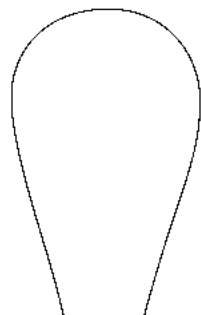

1404-1925 25,0 mm

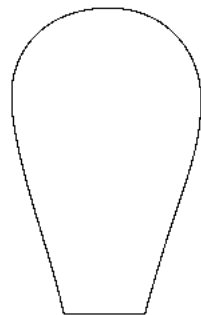

1404-1804 25,0 mm



COBB

1404-1910 - 1404-1925 25,0 cm / 10"

COBB

1404-1801 - 1404-1804 28,0 cm / 11"

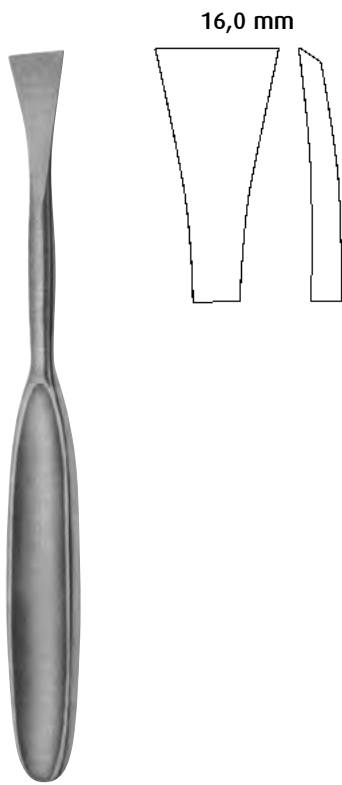

LANGENBECK
1404-0201 19,0 cm / 7½"

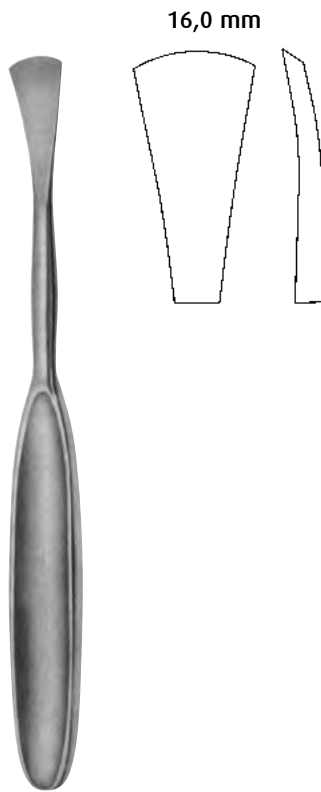

LANGENBECK
1404-0202 19,0 cm / 7½"

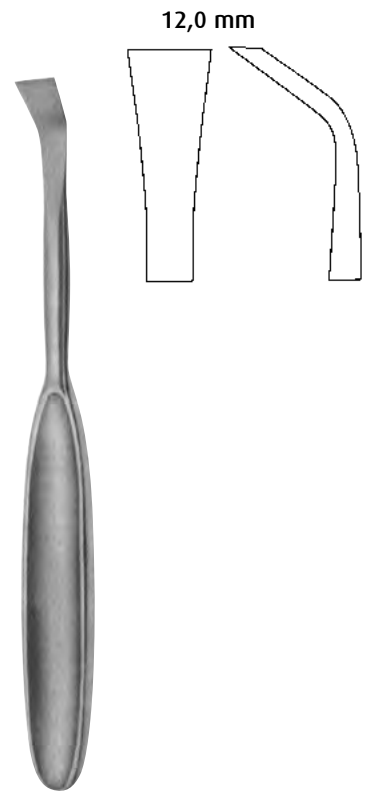

LANGENBECK
1404-0203 18,5 cm / 7¼"

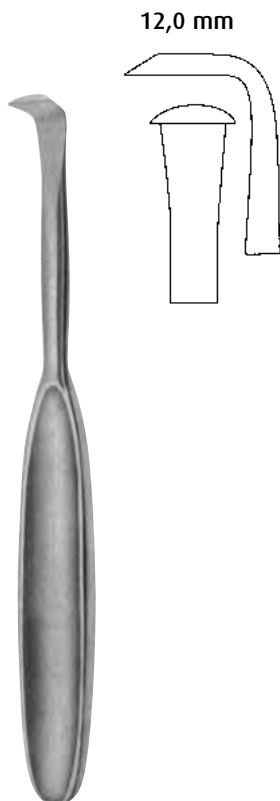

LANGENBECK
1404-0204 18,0 cm / 7"

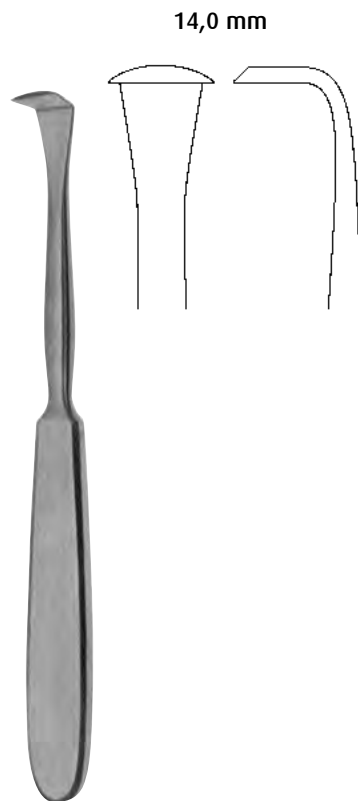

LANGENBECK
1404-0205 18,0 cm / 7"

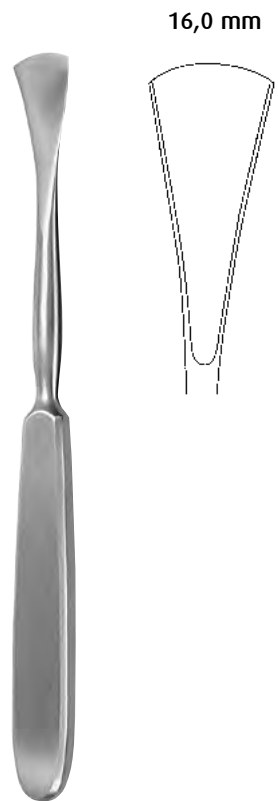

LANGENBECK
1404-0102 19,0 cm / 7½"

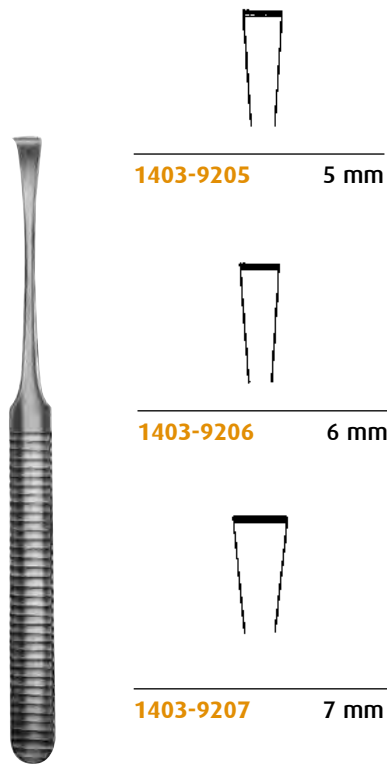

1403-9205 5 mm

1403-9206 6 mm

1403-9207 7 mm

1403-9205 - 1403-9207 16,0 cm / 6 1/4"

12,5 mm



FARABEUF

1403-9214 15,0 cm / 6"

12,5 mm



FARABEUF

1403-9314 15,0 cm / 6"

15,0 mm



SEDILOT

1404-0421 21,0 cm / 8 1/4"

4,0 mm

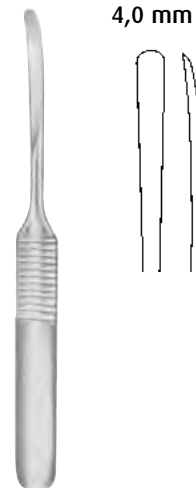

WILLIGER

1403-5515 14,0 cm / 5 1/2"

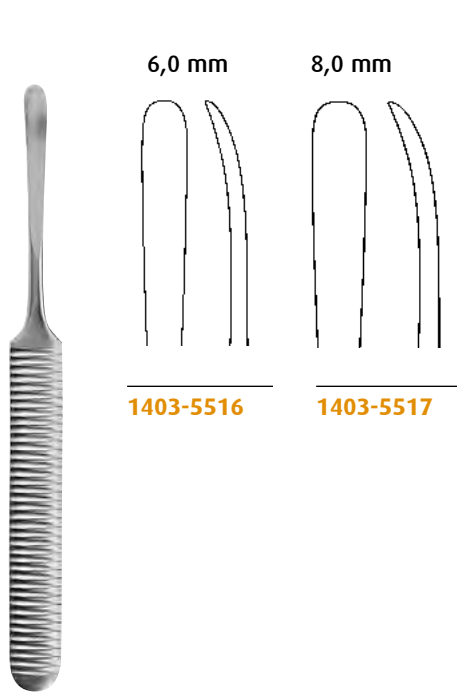

1403-5516

1403-5517

WILLIGER

1403-5516 - 1403-5517

16,0 cm / 6¹/₄"

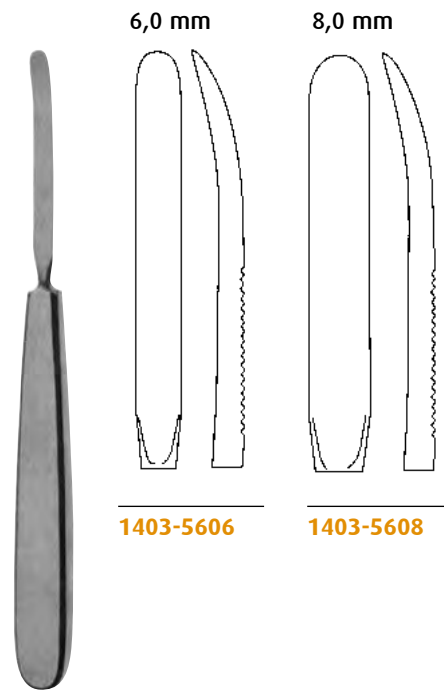

6,0 mm

8,0 mm

1403-5606

1403-5608

1403-5606 - 1403-5608

17,0 cm / 6³/₄"



Für Kinder
for children
para niños
per bambini

DOYEN

1404-0901

17,0 cm / 6³/₄"



Für Kinder
for children
para niños
per bambini

DOYEN

1404-0902

17,0 cm / 6³/₄"



Für Erwachsene
for adults
para adultos
per adulti

DOYEN

1404-1001 17,0 cm / 6³/₄"



Für Erwachsene
for adults
para adultos
per adulti

DOYEN

1404-1002 17,0 cm / 6³/₄"



10,0 mm

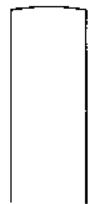

1404-0510

15,0 mm



1404-0515

20,0 mm

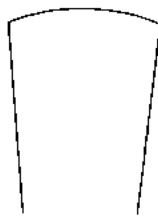

1404-0520

25,0 mm

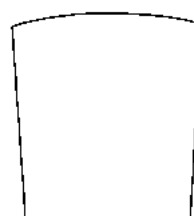

1404-0525

LAMBOTTE

1404-0510 - 1404-0525 21,0 cm / 8¹/₄"

12,0 mm

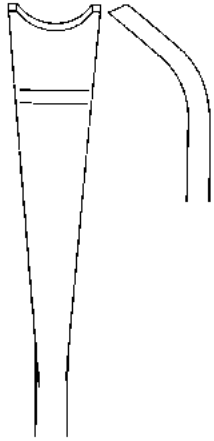

Fig. 1

1404-0801 19,0 cm / 7½"

12,0 mm

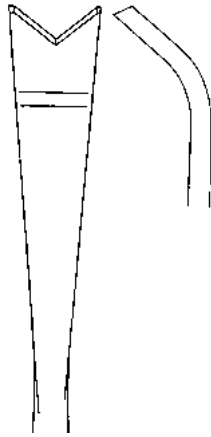

Fig. 2

1404-0802 23,0 cm / 9"

13,0 mm

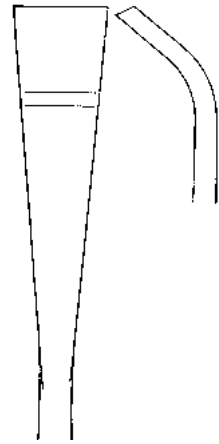

Fig. 3

1404-0804 23,0 cm / 9"



13,0 mm



Fig. 4

1404-0805 23,0 cm / 9"

16,0 mm

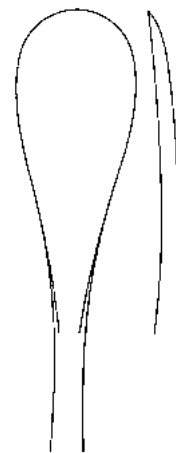
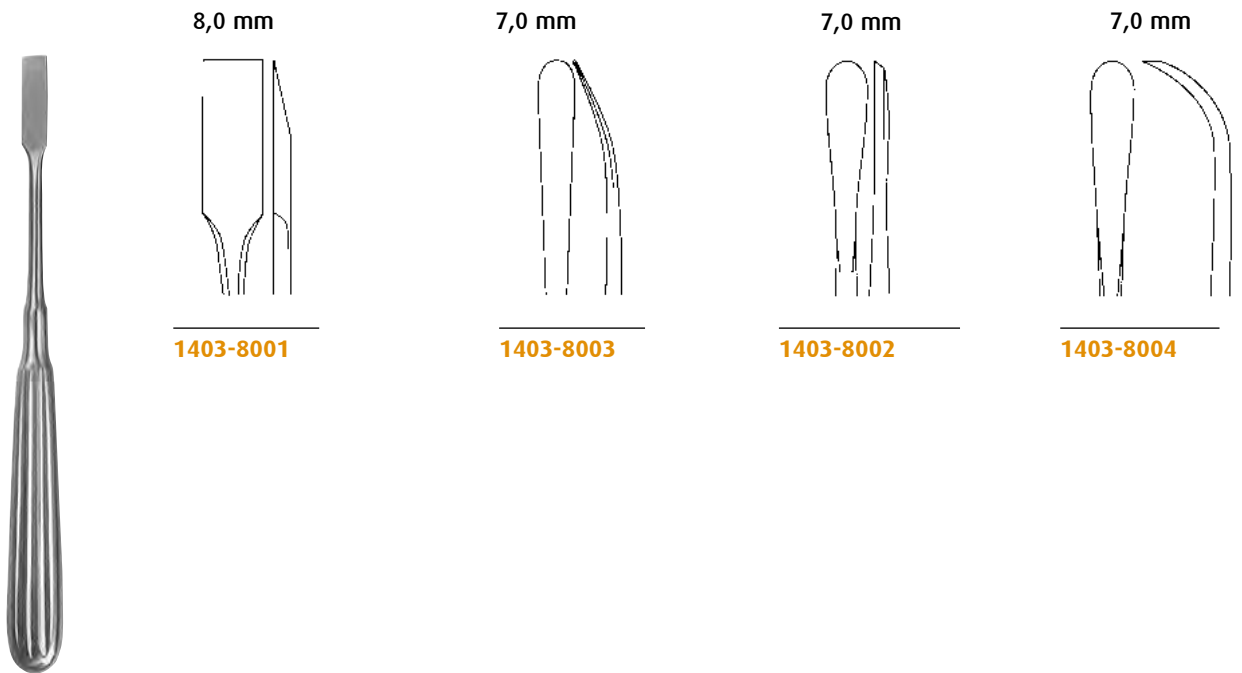

Fig. 5

1404-0807 23,0 cm / 9"

SEMB

1404-0801 - 1404-0807



ADSON

1403-8001 - 1403-8004 17,0 cm / 6³/₄"

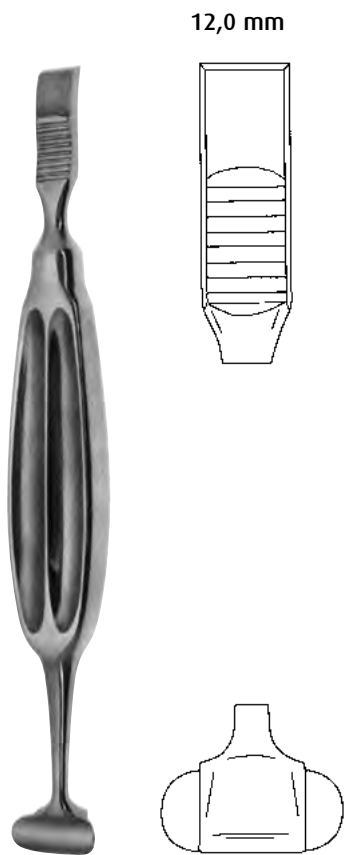

ALEXANDER

1404-0621 21,0 cm / 8¹/₄"

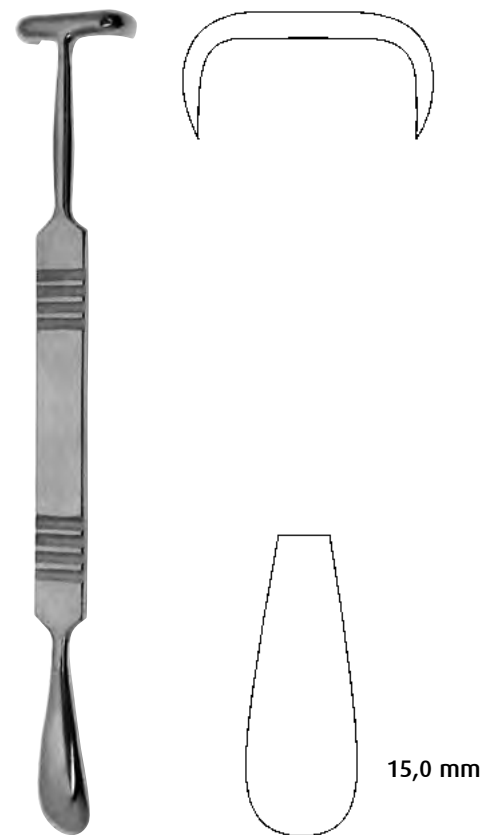

MATSON

1404-0622 22,0 cm / 8³/₄"

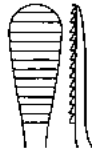

Fig. 1

1404-4711

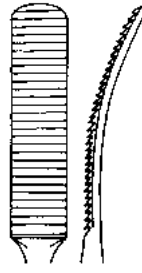

Fig. 2

1404-4712

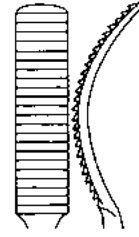

Fig. 3

1404-4713



abwärts schneidend
downwards cutting
corte abajo
tagliente in basso

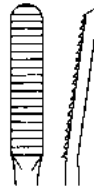

Fig. 4

1404-4714

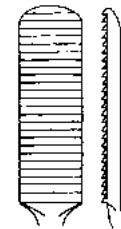
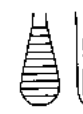

Fig. 5

1404-4715



MILLER-COLBURN

1404-4711 - 1404-4715 18,0 cm / 7"

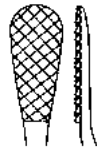

Fig. 1
1404-4801

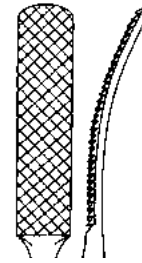

Fig. 2
1404-4802



Fig. 3
1404-4803

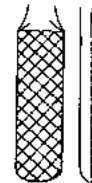
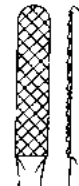
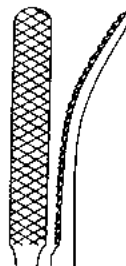

Fig. 4
1404-4804



Kreuzhieb
 cross cut
 picado en cruz
 tagleinte a croce

MILLER-COLBRUN

1404-4801 - 1404-4804 18,0 cm / 7"

Knochenfeilen
Bone files
Limas para huesos
Lima per ossa

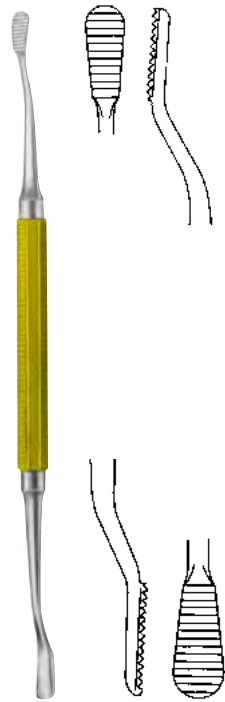

TC-MILLER-COLBRUN
1404-4805 18,5 cm / 7¹/₄"

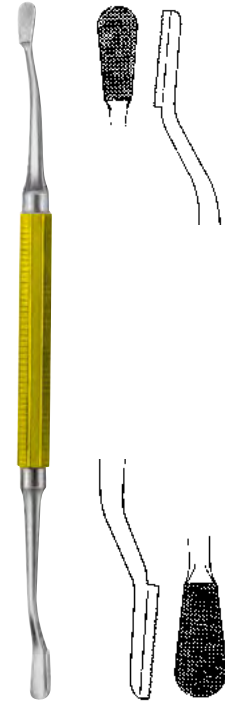

TC-MILLER-COLBRUN
1404-4806 18,5 cm / 7¹/₄"



1404-4928 28,0 cm / 11"



1404-4924 24,5 cm / 9²/₃"



1404-4822 22,0 cm / 8³/₄"



PUTTI

1404-5130 30,0 cm / 12"



PUTTI

1404-5127 27,0 cm / 10³/₄"



LANGENBECK

1404-2303 - 1404-2304 20,0 cm / 8"

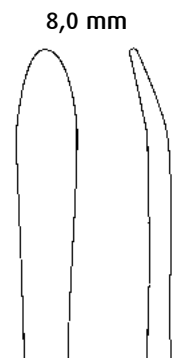

1404-2303

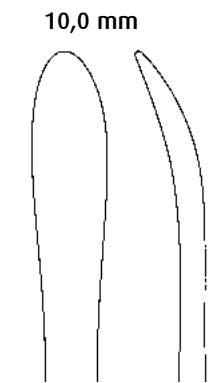

1404-2304

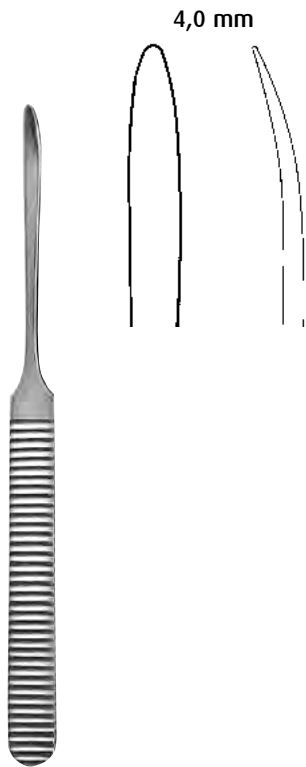

WILLIGER
 1404-2202 17,0 cm / 6³/₄"

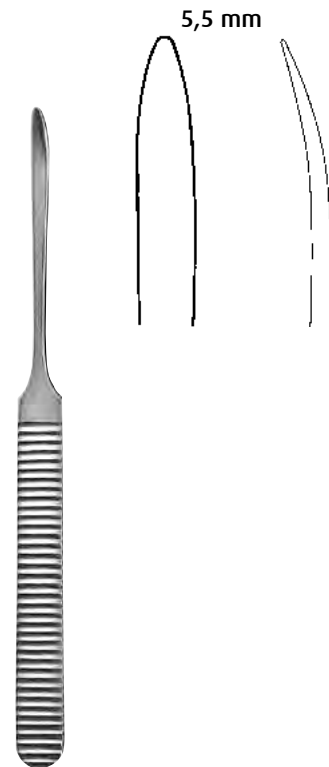

WILLIGER
 1404-2201 16,0 cm / 6¹/₄"



extrem leicht
 very light
 estremamente ligero
 estremamente leggero

1404-2204 17,0 cm / 6³/₄"



Mikro-Elevatorium
 Micro-Elevator
 Micro-Elevador
 Micro-Elevatorio

1404-2206 16,0 cm / 6¹/₄"

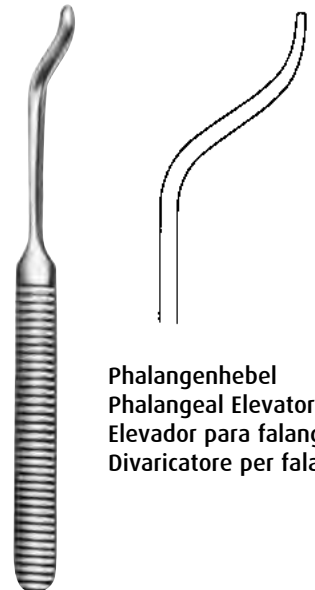

Phalangenhebel
 Phalangeal Elevator
 Elevador para falanges
 Divaricatore per falanghe

1404-2116 16,0 cm / 6¹/₄"

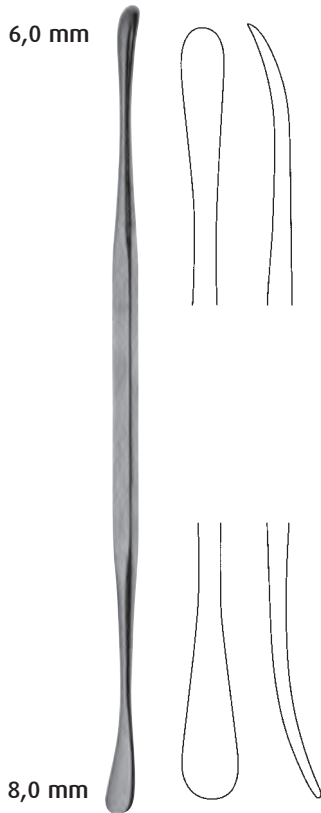

ALDERDYCE

1403-6421 21,0 cm / 8 1/4"

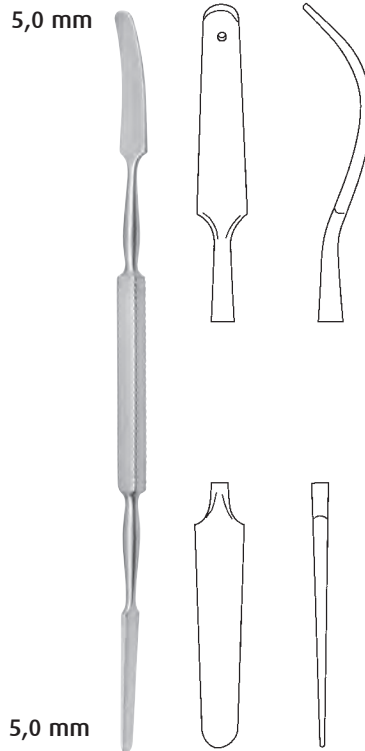

MC DONALD

1403-6618 19,0 cm / 7 1/2"

WATSON-CHEYNE

1403-6613 13,0 cm / 5 1/8"

1403-6619 19,0 cm / 7 1/2"

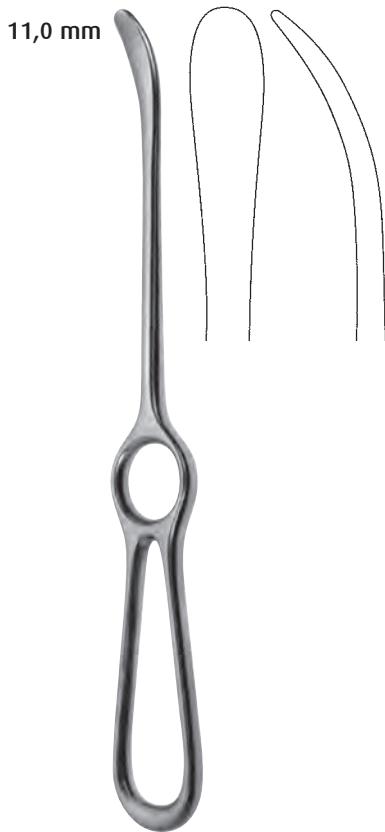

LANGENBECK

1404-2305 23,0 cm / 9"

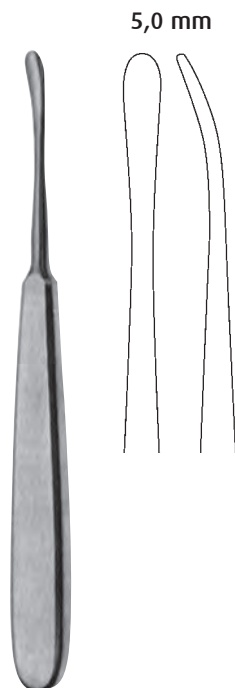

SEBILEAU

1404-2301 17,0 cm / 6 3/4"

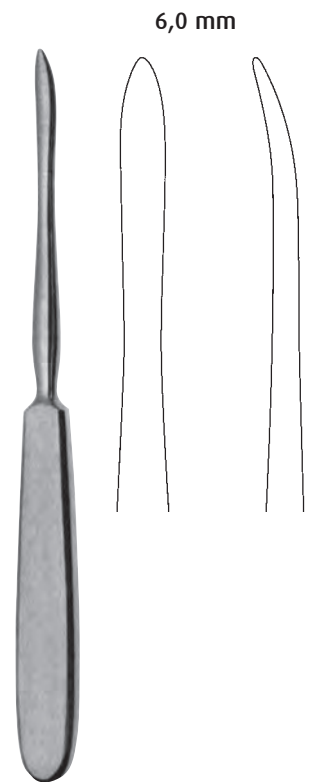

QUERVAIN

1404-2302 19,5 cm / 7 3/4"

2,8 mm

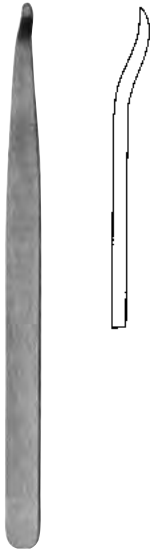

1404-2401 14,0 cm / 5 1/2"

5,0 mm

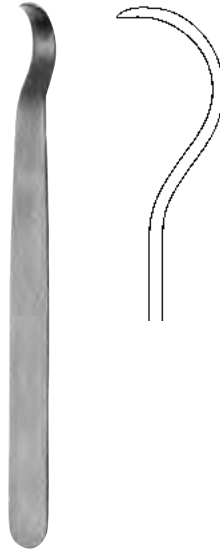

1404-2402 15,0 cm / 6"

7,0 mm

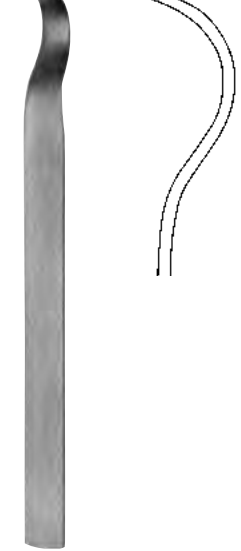

1404-2403 15,0 cm / 6 "

2,0 mm

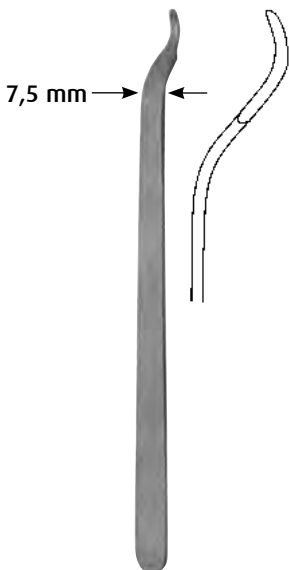

BUCK-GRAMCKO
1404-2501 15,0 cm / 6"

2,0 mm

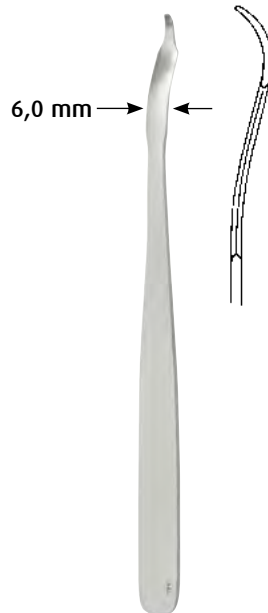

MINI-HOHMANN
1404-2502 16,0 cm / 6 1/4"

2,0 mm

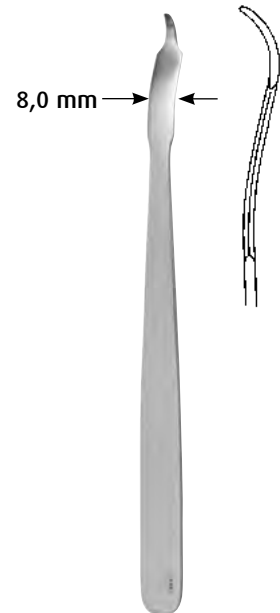

MINI-HOHMANN
1404-2503 16,0 cm / 6 1/4"

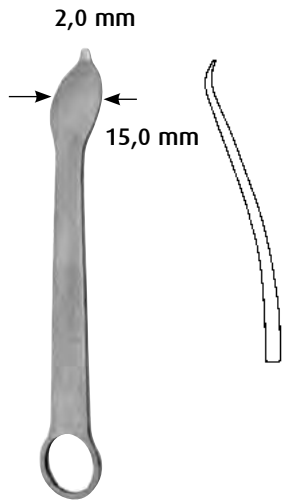

KNOCHENHEBEL

1404-2504 12,5 cm / 5"

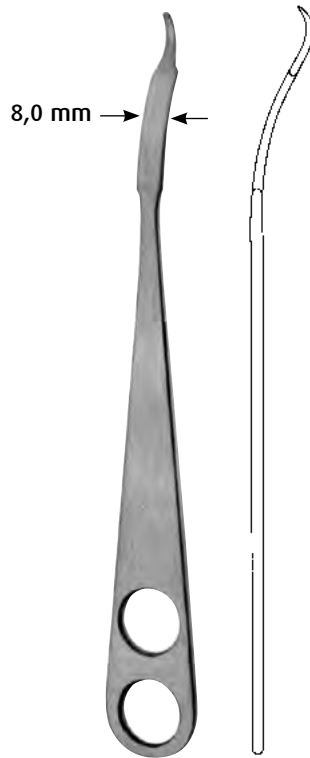

HOHMANN

1404-2800 22,0 cm / 8³/₄"

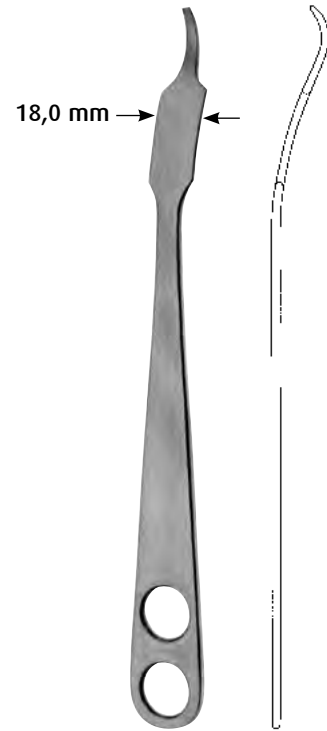

HOHMANN

1404-2802 23,5 cm / 9¹/₄"

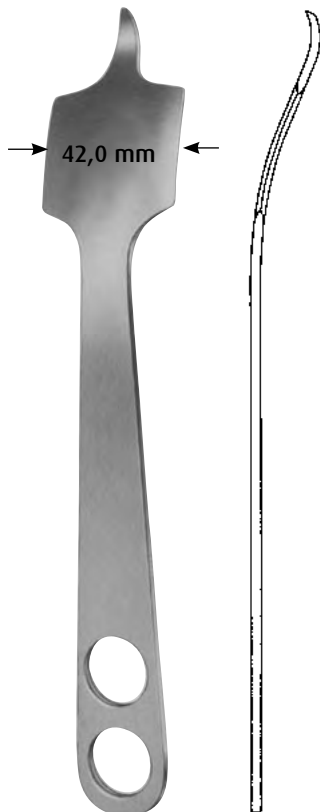

HOHMANN

1404-2803 24,0 cm / 9¹/₄"

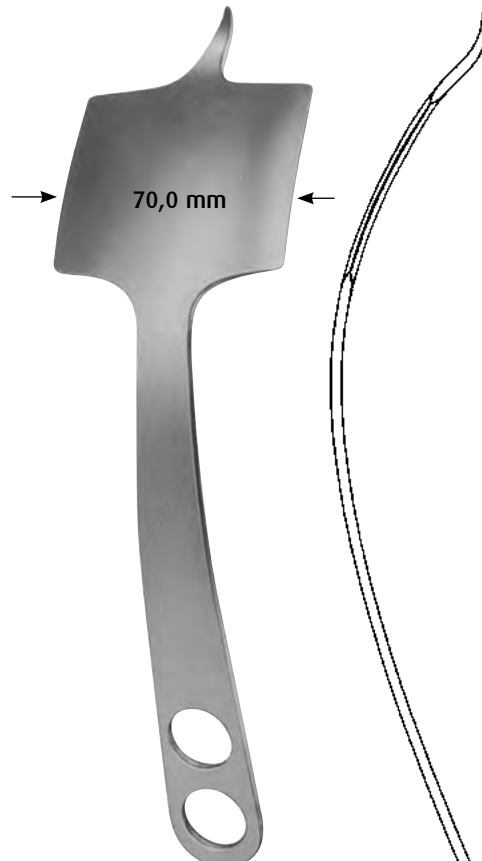

HOHMANN

1404-2804 25,0 cm / 9³/₄"

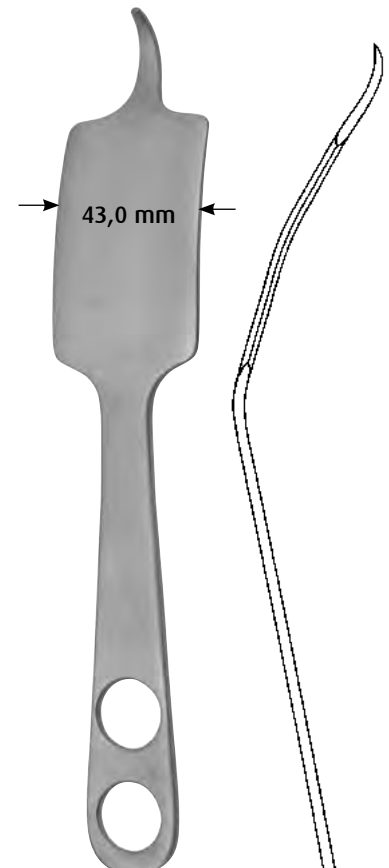

HOHMANN

1404-2810 23,5 cm / 9¹/₄"

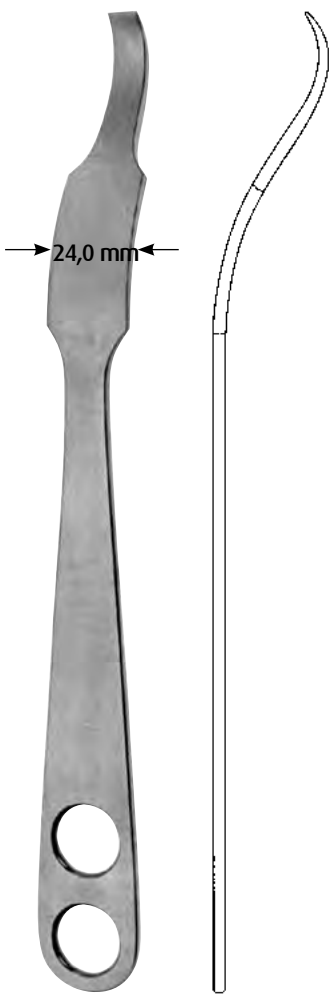

HOHMANN
1404-2806 26,0 cm / 10¹/₄"

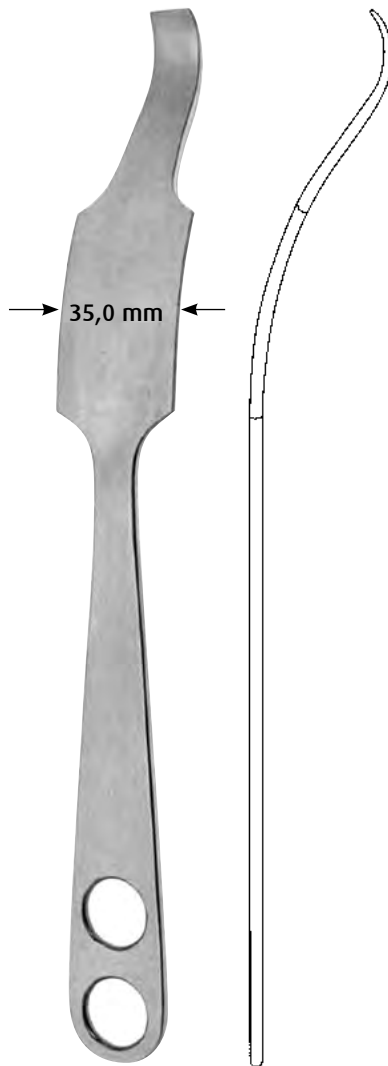

HOHMANN
1404-2807 29,0 cm / 11¹/₄"

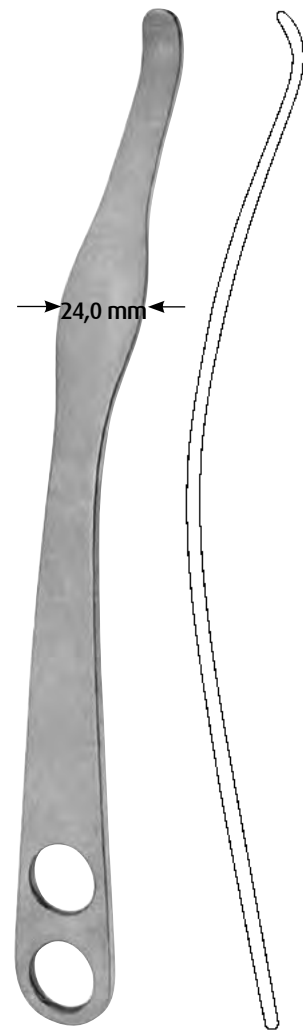

HOHMANN
1404-2808 27,5 cm / 10³/₄"

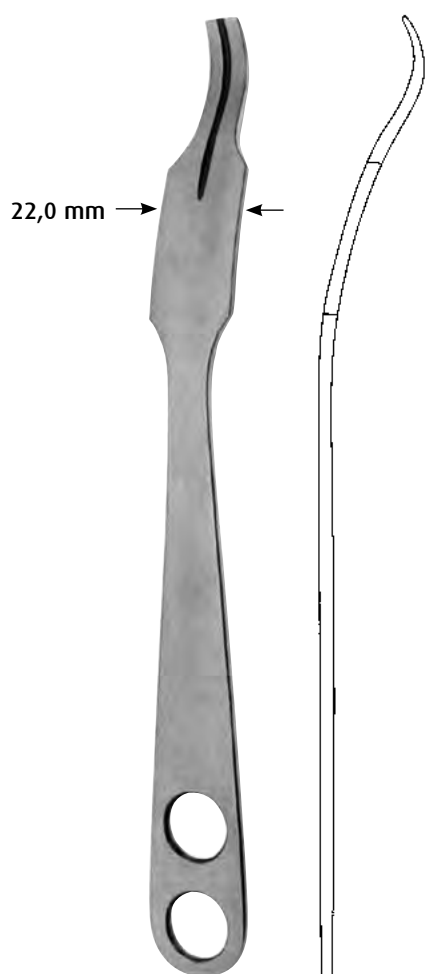

LANGE-HOHMANN

1404-2809 25,0 cm / 9³/₄"

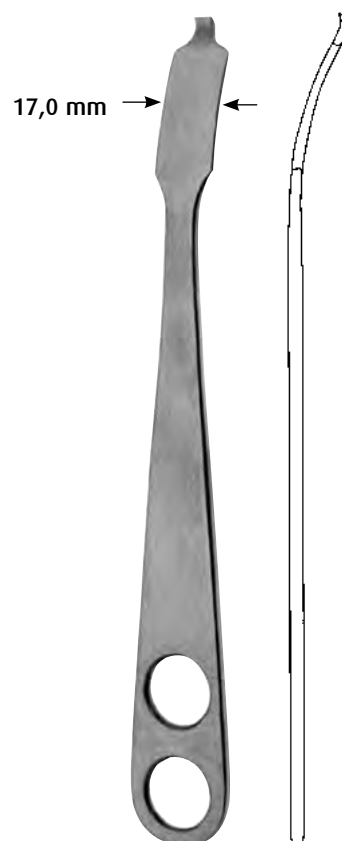

WAGNER

1404-3001 22,0 cm / 8³/₄"

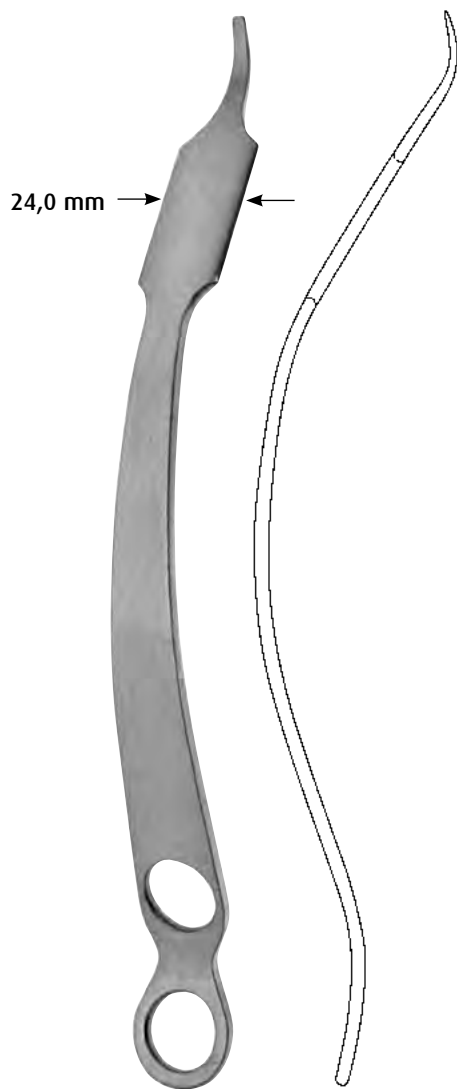

HOHMANN-ALDINGER

1404-3127 28,0 cm / 11"

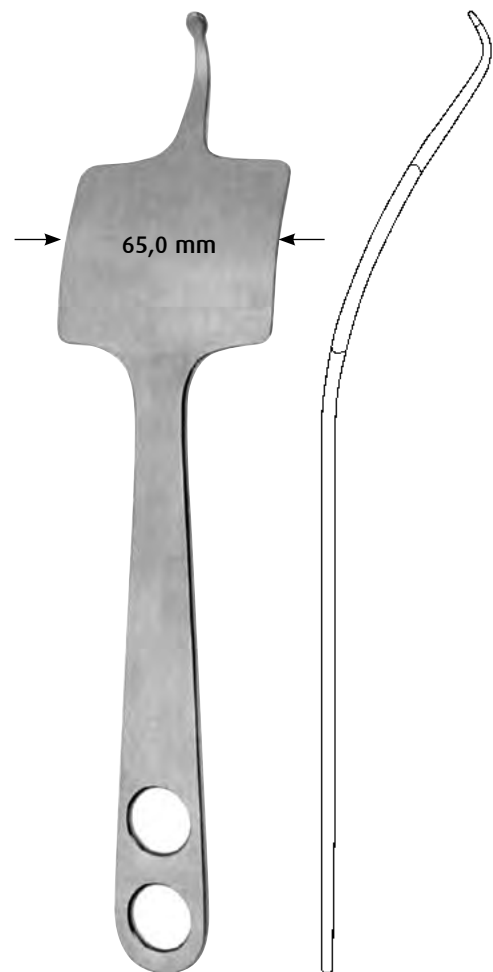

MÜLLER-VERBRUGGE

1404-3201 25,5 cm / 10"

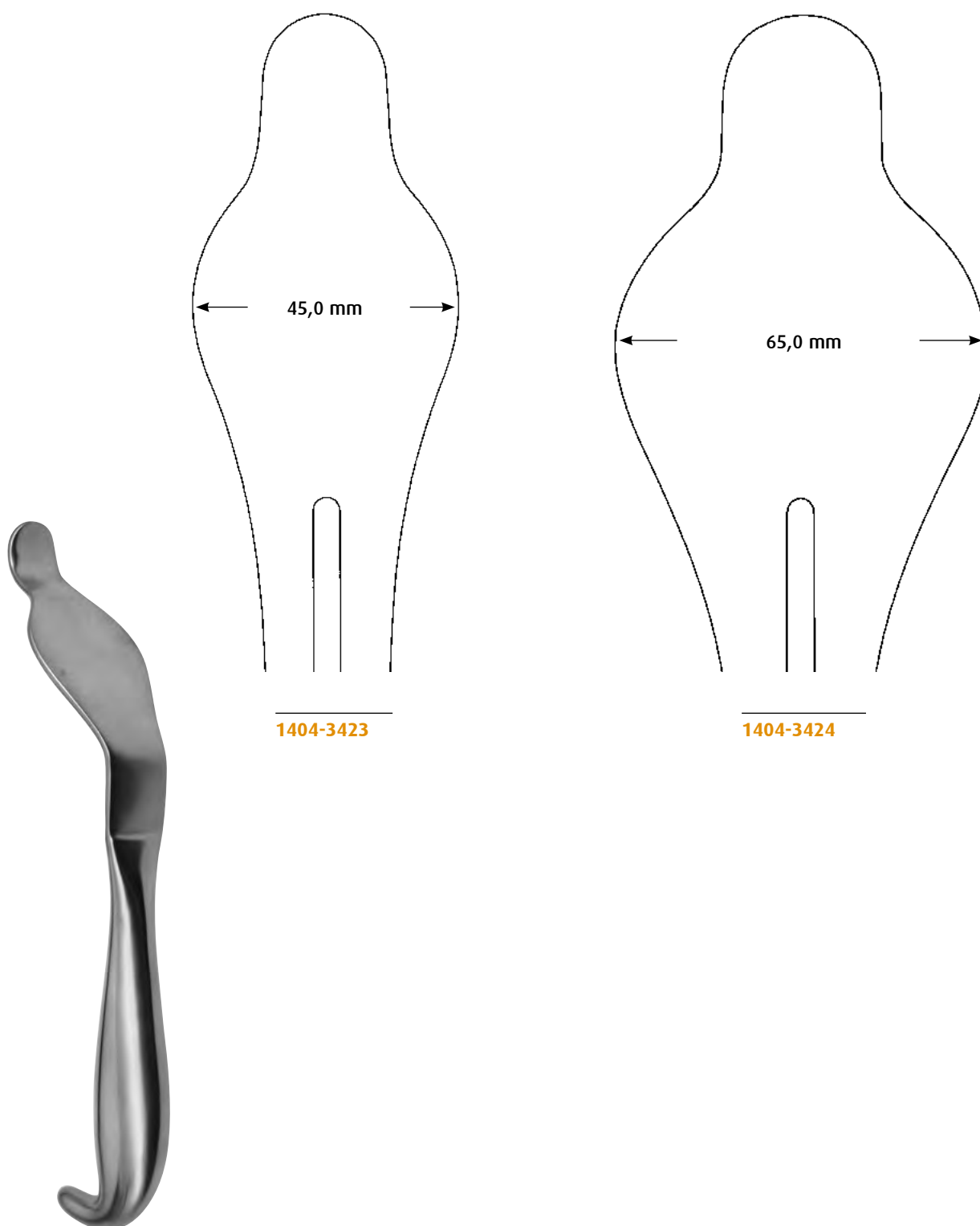

BENNET

1404-3423 - 1404-3424

25,0 cm / 10"

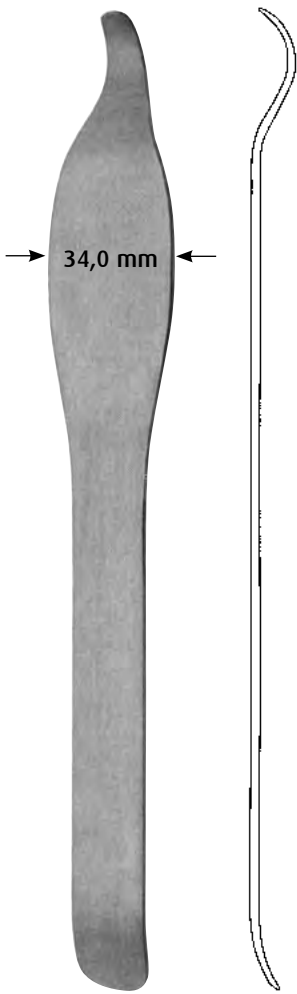

BLOUNT

1407-6226 26,0 cm / 10¹/₄"

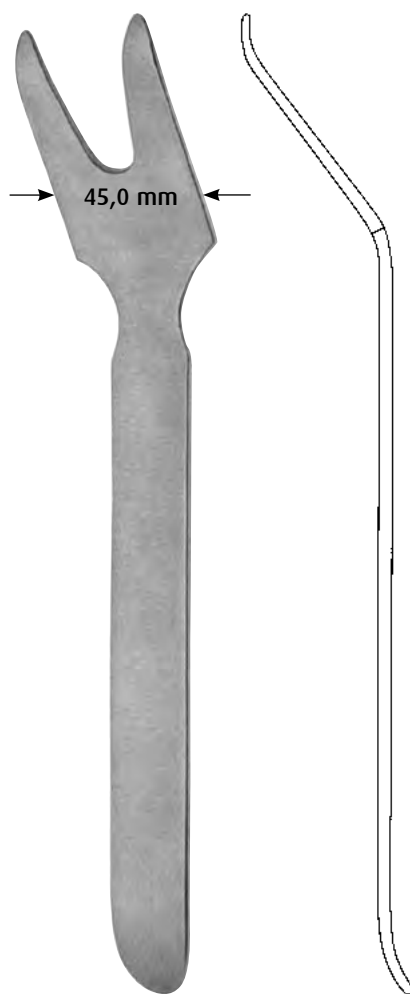

BLOUNT

1407-6227 26,0 cm / 10¹/₄"

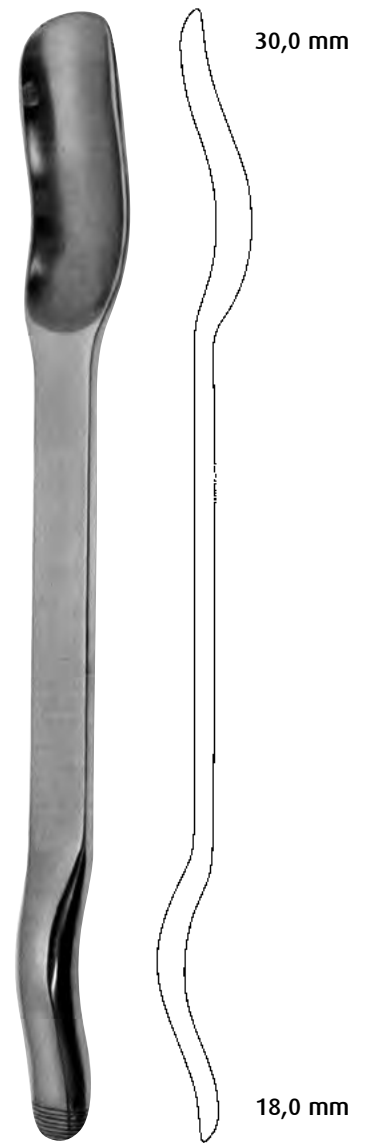

MURPHY-LANE

1404-3534 30,0 cm / 12"

**BLOUNT**

1407-6217 17,5 cm / 7"

**TAYLOR**

1407-5975 -1407-5900 16,0 cm / 6¹/₂"

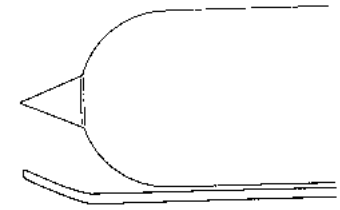

1407-5975

75 x 30 mm

1407-5900

100 x 30 mm



1407-6317

17,0 cm / 6³/₄"

Wund- und Meniskushaken
Retractor for Knee
Separadores para rodilla
Retrattori per ginocchio

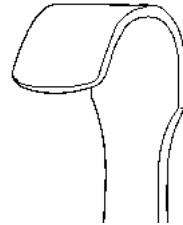
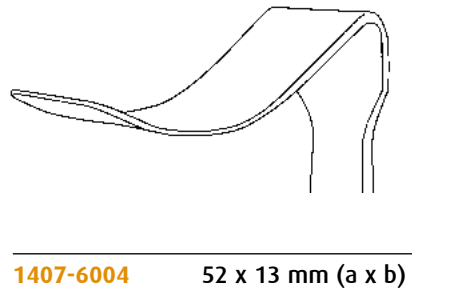
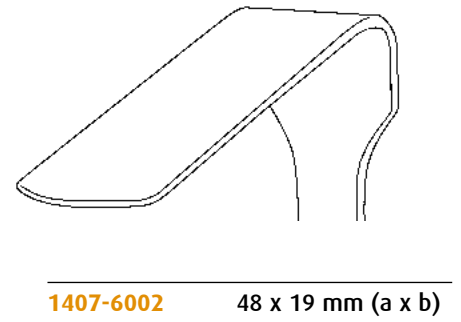
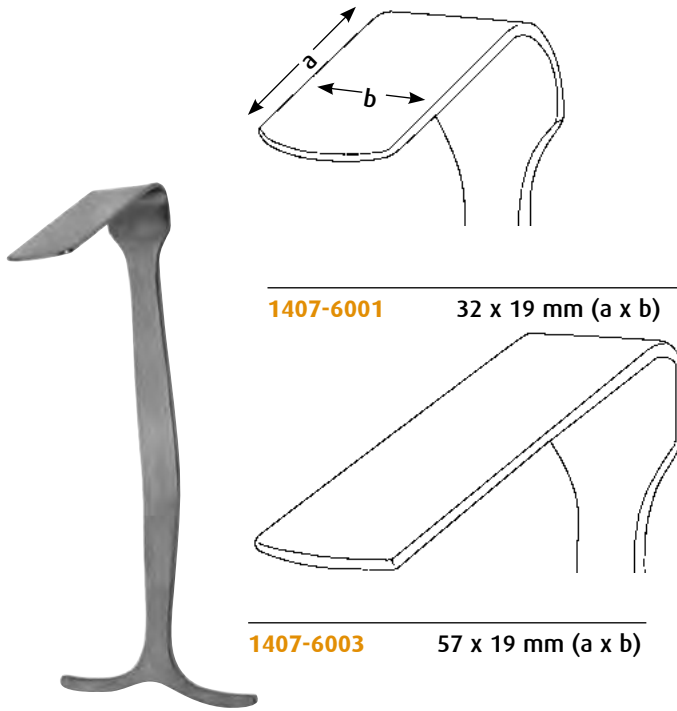

SMILLIE

1407-6001 - 1407-6005 14,0 cm / 5 1/2"

1407-6005 17 x 13 mm (a x b)



1407-6122 21,0 cm / 8 1/4"

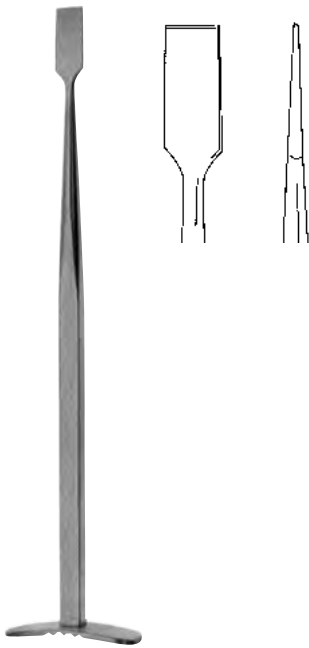

SMILLIE
1407-5501 17,0 cm / 6³/₂"

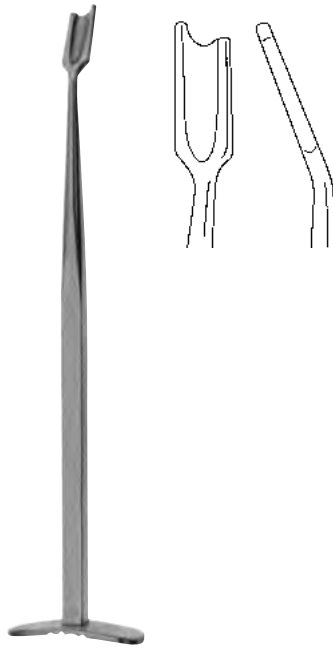

SMILLIE
1407-5502 17,0 cm / 6³/₄"

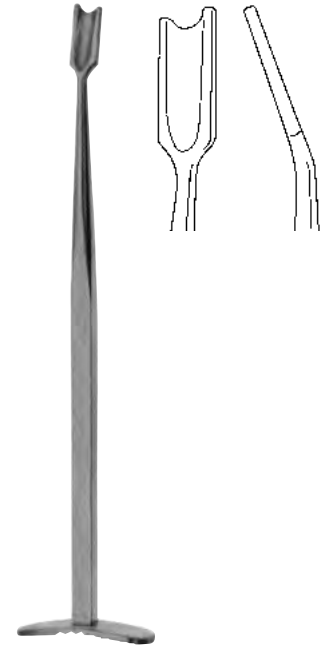

SMILLIE
1407-5503 17,0 cm / 6³/₄"



BIRCHER
1407-5401 19,0 cm / 7¹/₂"



BIRCHER
1407-5402 19,0 cm / 7¹/₂"

Meniskusmesser
Meniscus Knives
Bisturìes para menisco
Bisturi per menisco

024



NEFF

1407-4702

20,5 cm / 8"



NEFF

1407-4701

20,5 cm / 8"

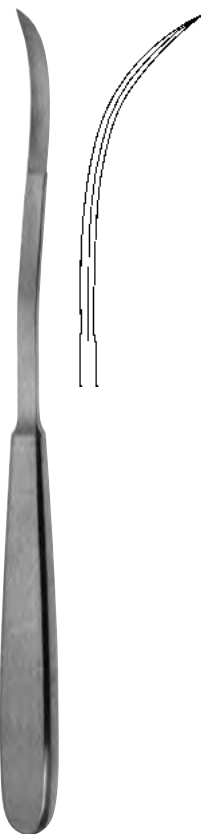

SALENIUS

1407-5102

22,0 cm / 8³/₄"

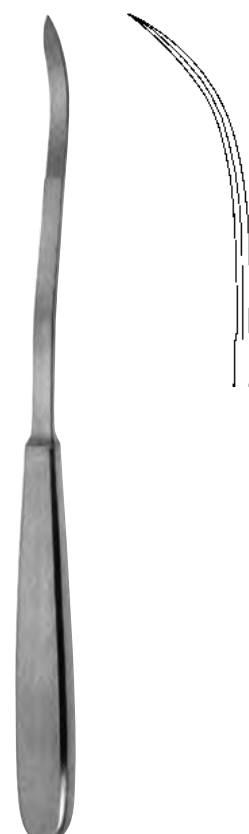

SALENIUS

1407-5101

22,0 cm / 8³/₄"



1407-8802 18,0 cm / 7"



- 

1407-8803 Ø 3,0 mm
- 

1407-8804 Ø 4,0 mm
- 

1407-8805 Ø 5,0 mm
- 

1407-8806 Ø 6,0 mm
- 

1407-8807 Ø 7,0 mm

BUNNELL

1407-8803 - 1407-8807 15,0 cm / 6"



- 

1407-8940 Ø 4,0 mm
- 

1407-8945 Ø 4,5 mm
- 

1407-8955 Ø 5,5 mm

flexibler Schaft
 flexible shaft
 vástago flexible
 gambo flessibile

1407-8940 - 1407-8955 23,0 cm / 9"

Sehnenführer, Sehenschäler
Tendon Passing Instruments, Tendon Strippers
Conductor de tendones, Mondador de tendones
Guida per tendine, Enucleatore per tendine

024

Ø 4,0 mm



FISCHER

1407-8231 31,0 cm / 12¹/₄"

Ø 5,0 mm



BUNNELL

1407-8623 23,0 cm / 9"

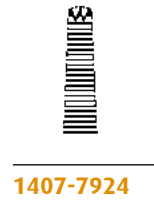
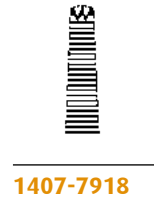
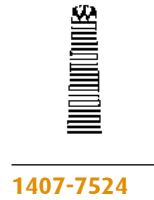

BRAND

- 1407-7815 15,0 cm / 6"
- 1407-7518 19,0 cm / 7 1/2"
- 1407-7524 24,0 cm / 9 1/2"

BRAND

- 1407-7915 15,0 cm / 6"
- 1407-7918 19,0 cm / 7 1/2"
- 1407-7924 24,0 cm / 9 1/2"



STEINMANN

- 1407-7416 16,0 cm / 6 1/4"

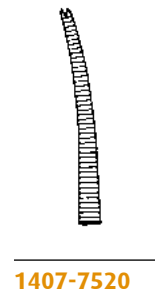
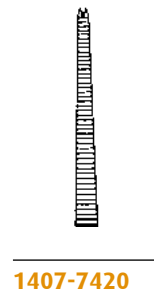

- 1407-7420 - 1407-7520 20,5 cm / 8"

Sehneneinflechtklemmen, Sehendurchziehzangen
Tendon Interlacing Forceps, Tendon Passing Forceps
Pinzas para entrelazar tendones, Pinzas para pasar tendones
Pinze per allacciare tendini, Pinze passa tendine



CAROLL

1407-7711 11,0 cm / 4³/₈"

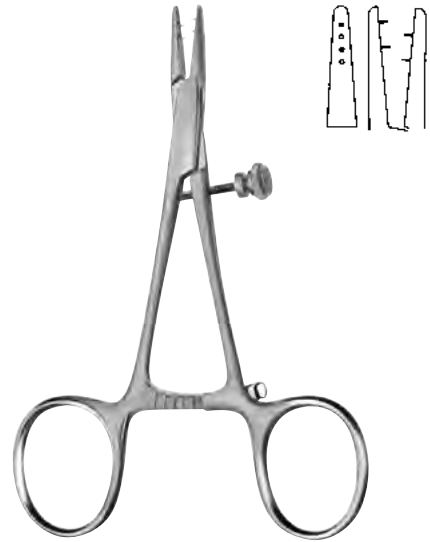

1407-2212 11,5 cm / 4¹/₂"t



KLEINERT-KUTZ

1407-8020 Ø 2,0 mm 20,5 cm / 8"
1407-8025 Ø 2,5 mm 20,5 cm / 8"



1407-7015 15,0 cm / 6"

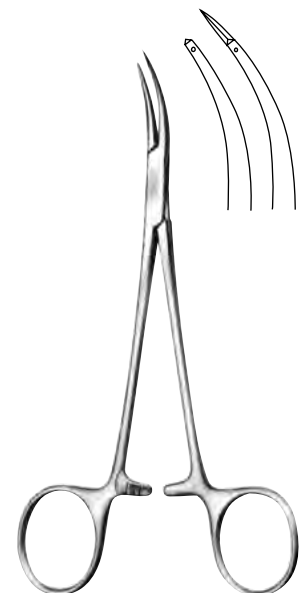

1407-7115 15,0 cm / 6"

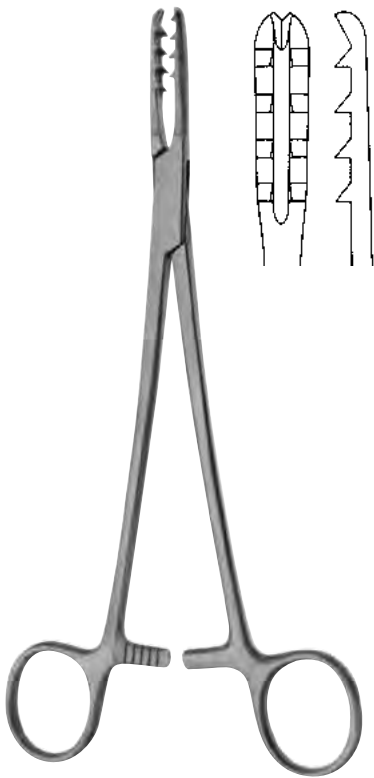

BIRCHER-GANSKE
 1407-3820 20,5 cm / 8"

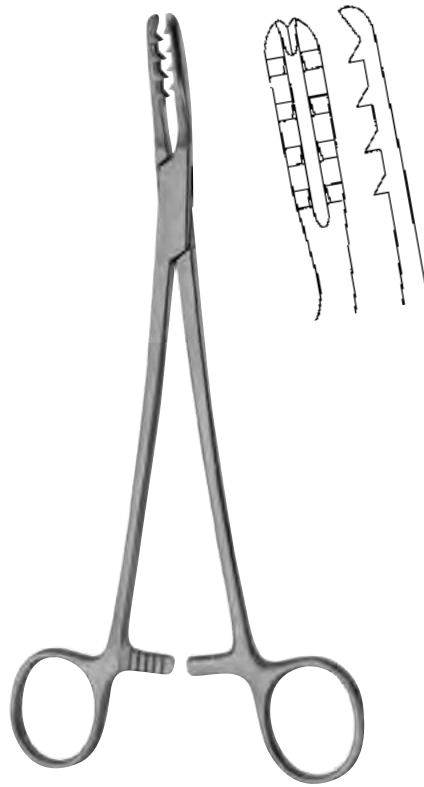

BIRCHER-GANSKE
 1407-3920 20,5 cm / 8"

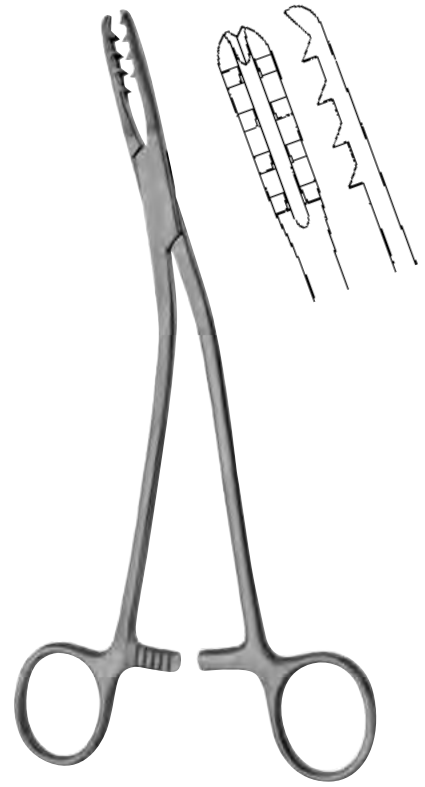

BIRCHER-GANSKE
 1407-3919 20,0 cm / 8"



1407-4114 14,0 cm / 5 1/4"



DINGMANN
 1405-2318 18,5 cm / 7 1/4"



MARTIN
 1407-4020 18,5 cm / 7 1/4"

Repositionszangen, Knochenhaltezangen
 Reposition Forceps, Bone Holding Forceps
 Pinzas para reposición, Pinzas para hueso
 Pinze per riposizioni, Tenaglie per ossa

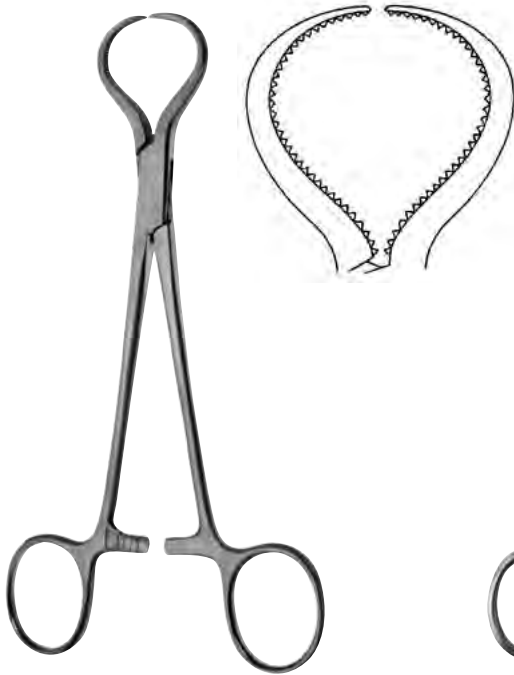

LEWIN

1405-0817 18,0 cm / 7"



1405-0313 14,0 cm / 5 1/2"



1405-0214 14,0 cm / 5 1/2"



lange Sperre, scharf
 long ratchet, pointed
 cremallera larga, aguda
 cremagliera lunga, acuta

1405-0612 13,5 cm / 5 1/4"



1405-1320 20,5 cm / 8"



1405-2420 20,0 cm / 8"



1405-2520 20,0 cm / 8"

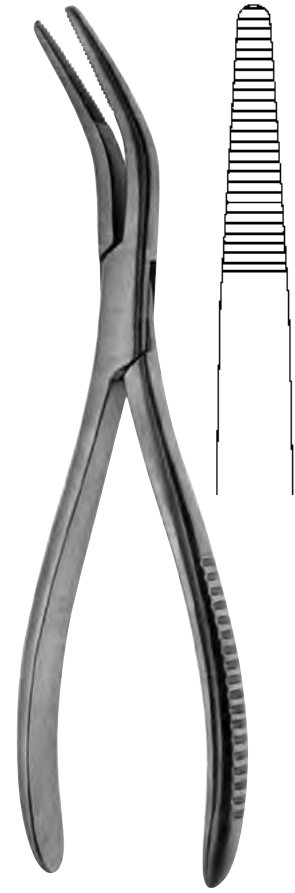

VAN BUREN
 1405-2723 23,0 cm / 9"



LANGENBECK
 1405-3020 21,0 cm / 9"



FERGUSON
 1405-3220 21,0 cm / 8¹/₄"

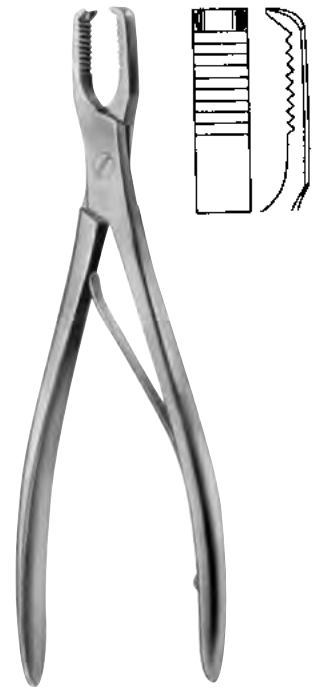

FROSC
 1405-3218 18,0 cm / 7"

Knochenhalte­zangen
Bone Holding Forceps
Pinzas para huesos
Tenaglie per ossa



LANGENBECK

1405-2820 20,0 cm / 8"



1405-2117

1405-2123

1405-2117 16,0 cm / 6¹/₄"
1405-2123 24,0 cm / 9¹/₂"



BABY-KERN

1405-4015 15,0 cm / 6"

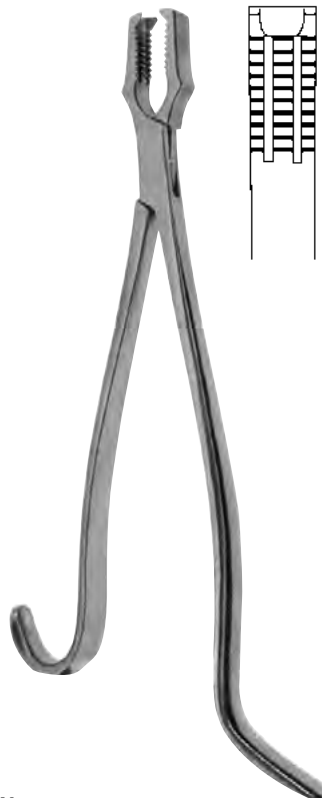

KERN

1405-4017 17,0 cm / 6³/₄"
1405-4021 21,0 cm / 8¹/₄"

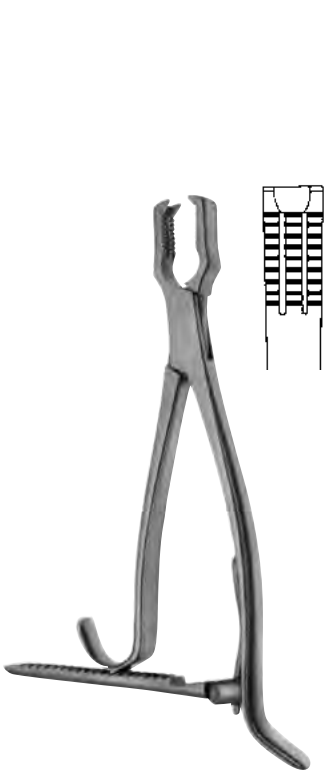

BABY-KERN
 1405-4215 15,0 cm / 6"



KERN
 1405-4217 17,0 cm / 6³/₄"
 1405-4221 21,0 cm / 8¹/₄"



SEMB
 1405-3319 19,0 cm / 7³/₄"



FARABEU
 1405-3623 23,0 cm / 9"
 1405-3625 26,0 cm / 10¹/₄"

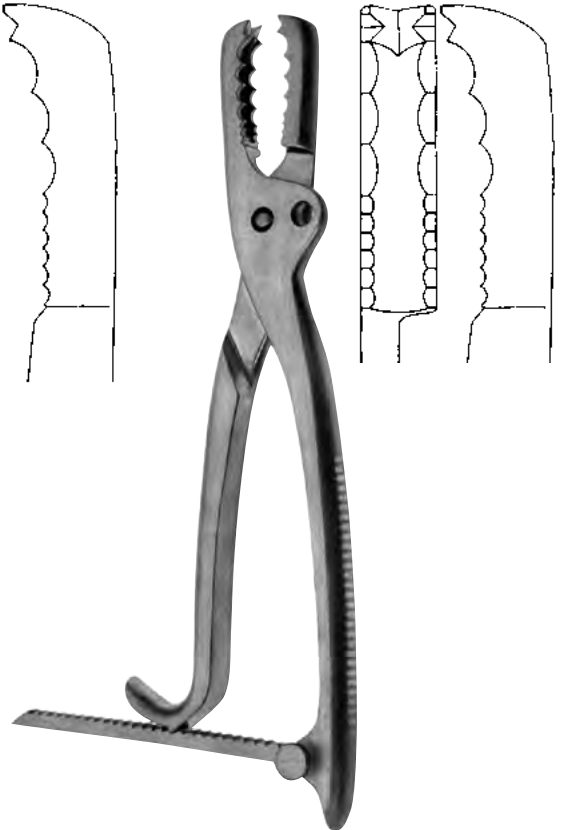
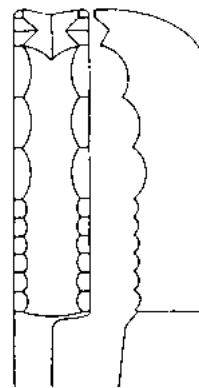

FARABEU-LAMBOTTE
 1405-3825 26,0 cm / 10"

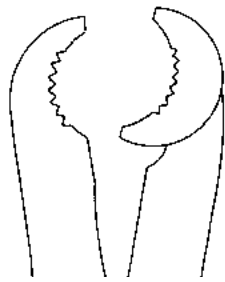

1405-5422

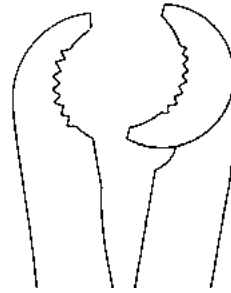

1405-5227

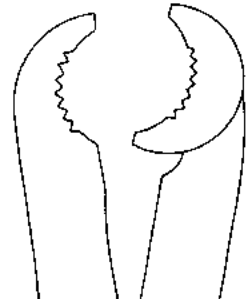

1405-5230

LAMBOTTE

- 1405-5422** 22,0 cm / 8³/₄"
- 1405-5227** 27,0 cm / 10³/₄"
- 1405-5230** 30,0 cm / 11³/₄"

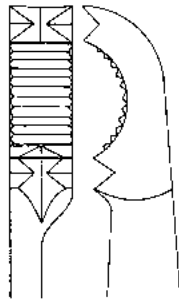

TUFFIER

1405-5527 27,0 cm / 10³/₄"



LAMBOTTE

1405-5519 19,0 cm / 7¹/₂"

**LANE**

1405-4033 33,0 cm / 13"
1405-4045 45,0 cm / 17³/₄"

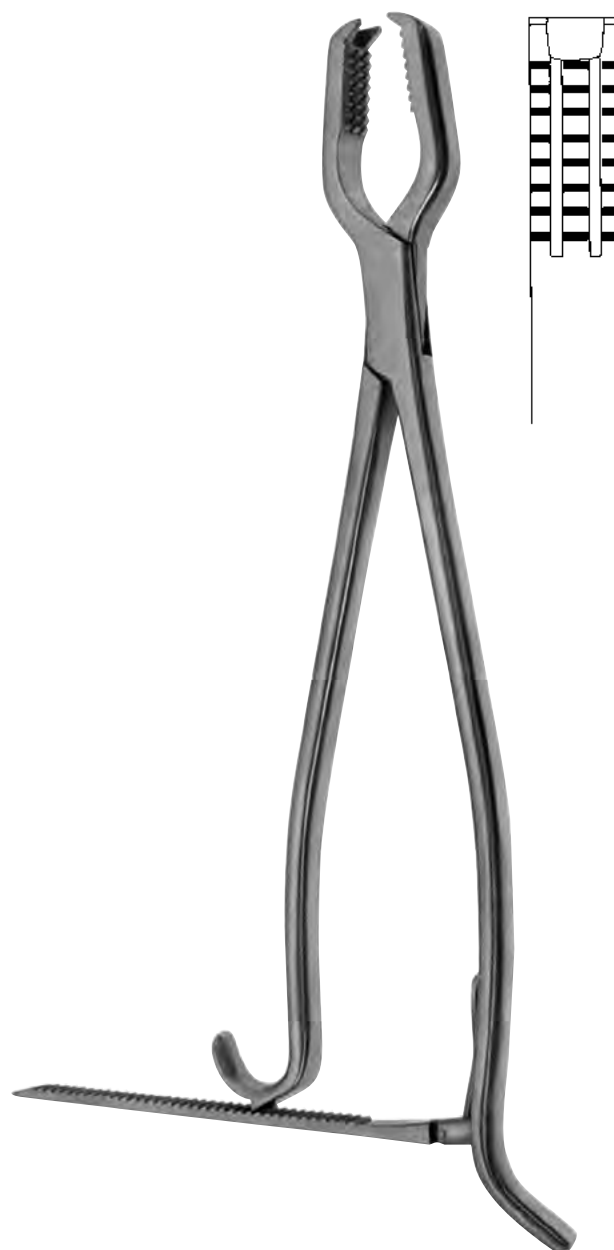
**LANE**

1405-4233 33,0 cm / 13"
1405-4245 45,0 cm / 17³/₄"

Knochenhalte­zangen
Bone Holding Forceps
Pinzas para huesos
Tenaglie per ossa

024



5,0 mm

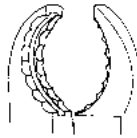

1405-4618

7,5 mm

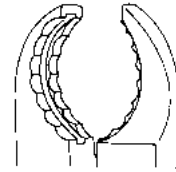

1405-4623

8,0 mm

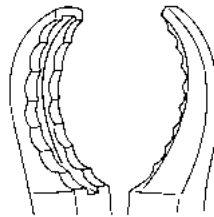

1405-4625

8,5 mm

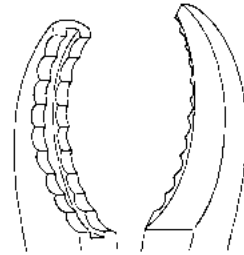

1405-4628

ULRICH

1405-4618	18,0 cm / 7"
1405-4623	23,0 cm / 9"
1405-4625	25,0 cm / 10"
1405-4628	28,0 cm / 11"

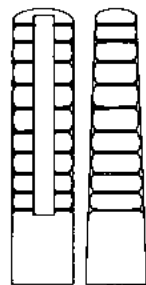

5,0 mm

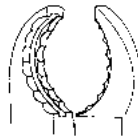

1405-4718

7,5 mm

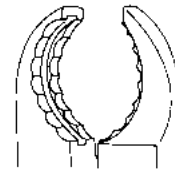

1405-4722

8,0 mm

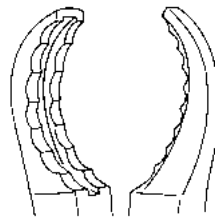

1405-4724

8,5 mm

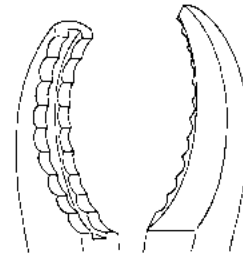

1405-4728

ULRICH

1405-4718	18,0 cm / 7"
1405-4722	23,0 cm / 9"
1405-4724	25,0 cm / 10"
1405-4728	28,0 cm / 11"

Knochenhalte­zangen
Bone Holding Forceps
Pinzas para huesos
Tenaglie per ossa

024

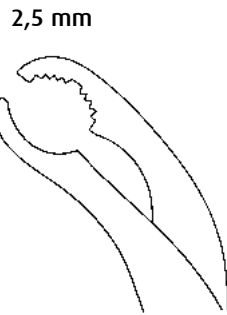

2,5 mm

1405-4915

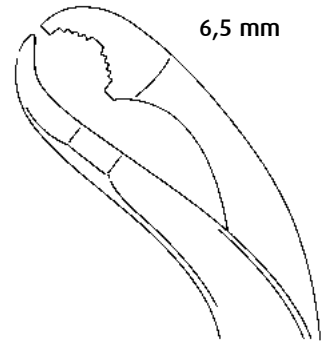

6,5 mm

1405-4919

selbstzentrierend mit Gewindesperre
 self-centering forceps with thread fixation
 autocentrante con cremallera de rosca
 pinze autocentranti con blocco di filettatura

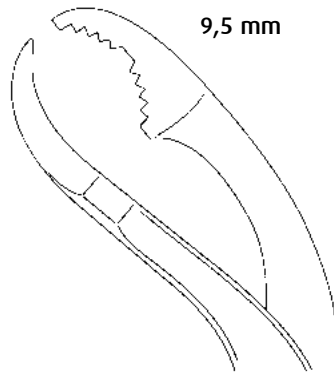

9,5 mm

1405-4924

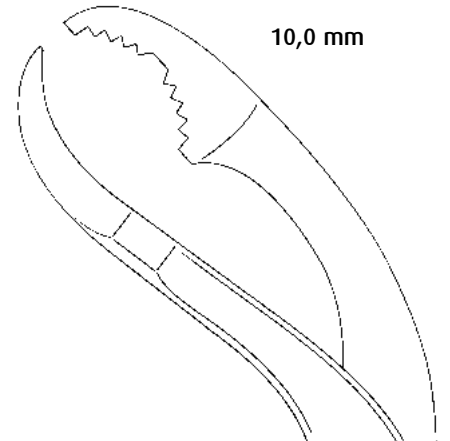

10,0 mm

1405-4926

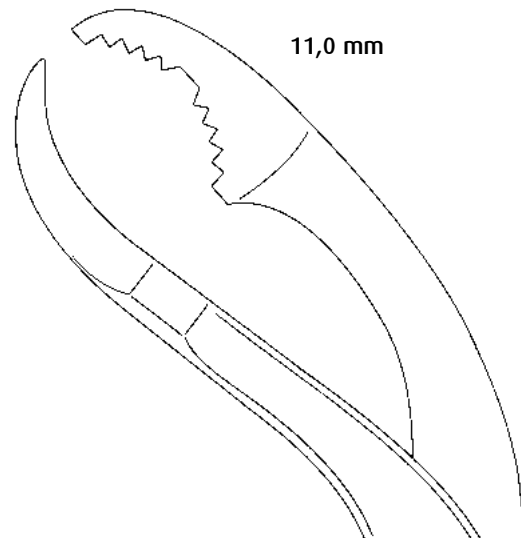

11,0 mm

1405-4928

- 1405-4915** 15,0 cm / 6"
- 1405-4919** 19,0 cm / 7½"
- 1405-4924** 24,0 cm / 9½"
- 1405-4926** 26,0 cm / 10¼"
- 1405-4928** 28,0 cm / 11"

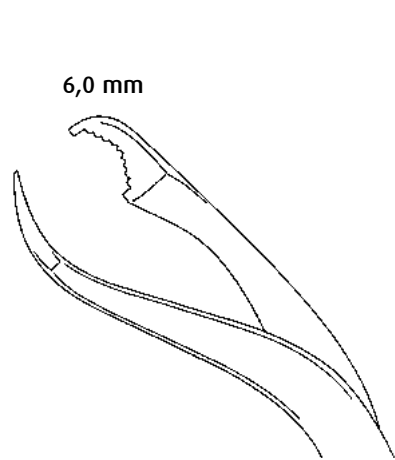

1405-5117

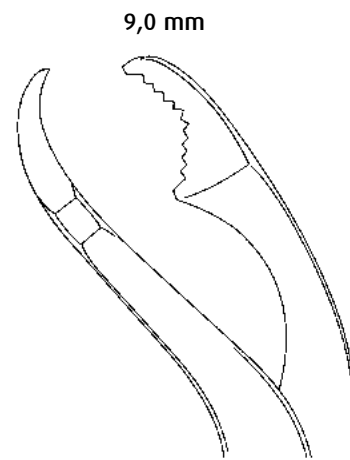

1405-5125

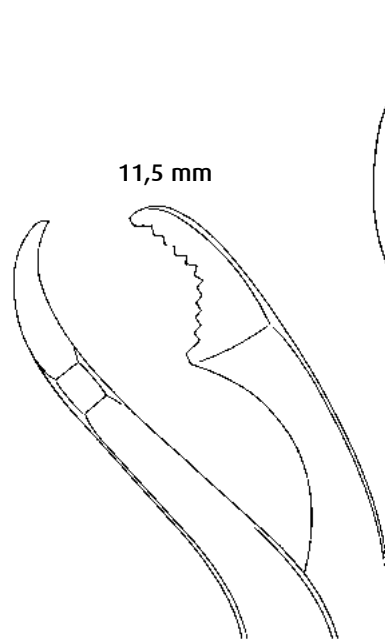

1405-5126

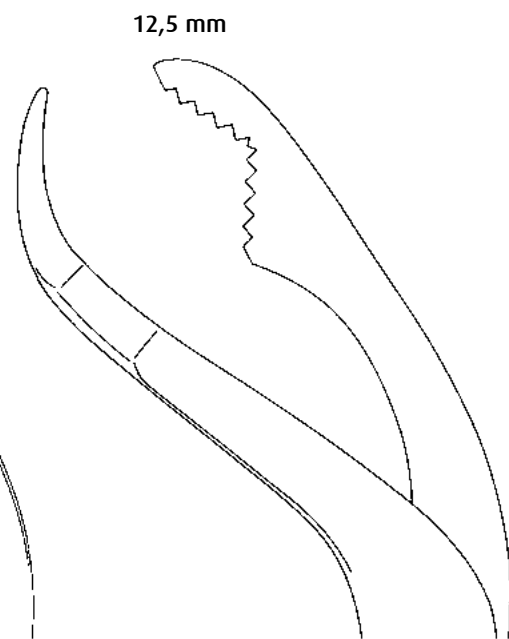

1405-5127

VERBRUGGE

1405-5117	17,5 cm / 7"
1405-5125	25,0 cm / 10"
1405-5126	26,0 cm / 10 ¹ / ₄ "
1405-5127	27,0 cm / 10 ³ / ₄ "

Hohlmeißelzangen
Bone Rongeurs
Pinzas-gubias
Pinze per ossa

024

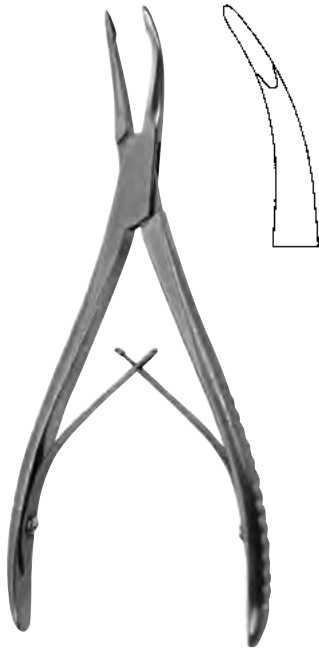

STELLBRINK
1406-0501 17,5 cm / 7"

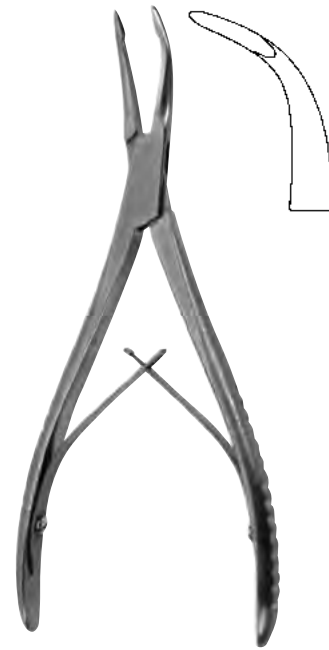

STELLBRINK
1406-0502 17,5 cm / 7"

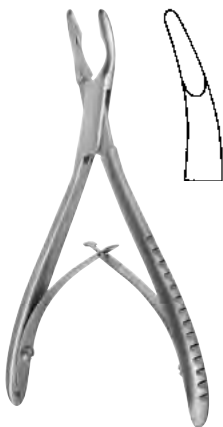

MINI-FRIEDMANN
1406-0712 12,0 cm / 4³/₄"

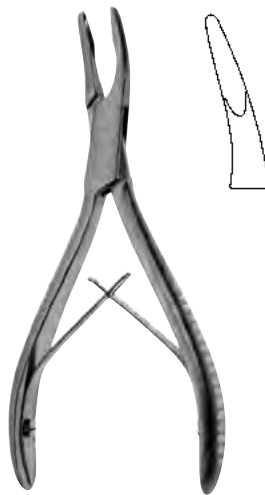

FRIEDMANN
1406-0714 14,0 cm / 5¹/₂"

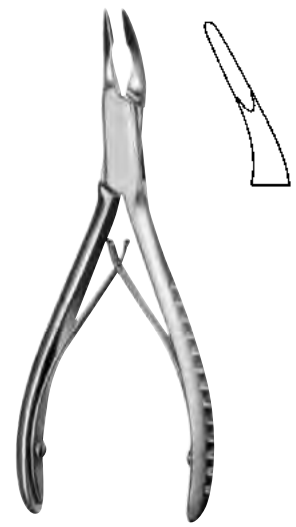

FRIEDMANN-VICKERS
1406-0814 14,0 cm / 5¹/₂"

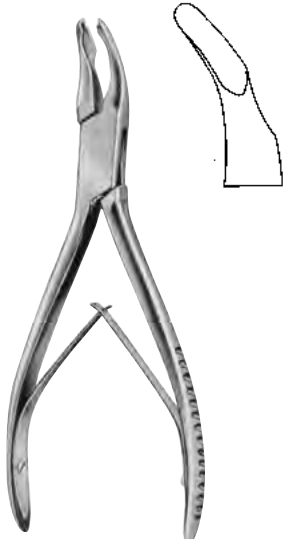

CLEVELAND
1406-1314 14,0 cm / 5 1/2"



CLEVELAND
1406-1317 17,0 cm / 6 3/4"



MEAD
1406-2701 16,5 cm / 6 1/2"



HARTMANN
1406-1917 18,0 cm / 7"



1406-1817



1406-1717

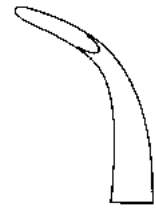

1406-1716

JANSEN
1406-1817 18,0 cm / 7"
1406-1717 18,0 cm / 7"
1406-1716 18,0 cm / 7"

Hohlmeißelzangen
 Bone Rongeurs
 Pinzas-gubias
 Pinze per ossa

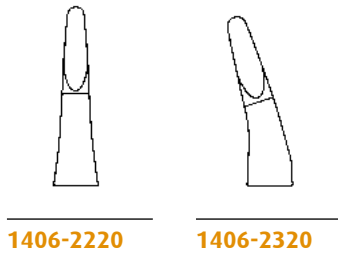

LEMPERT

1406-2220 - 1406-2320

19,0 cm / 7 1/2"

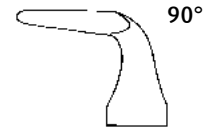
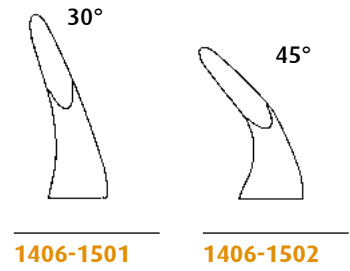

BLUMENTHAL

1406-1501 - 1406-1503

15,5 cm / 6"

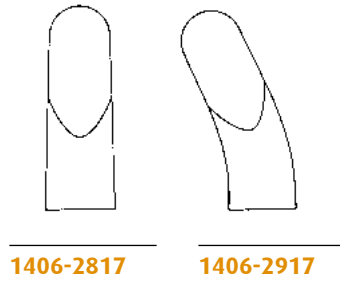

LUER

1406-2817 17,0 cm / 6 3/4"
 1406-2917 17,0 cm / 6 3/4"

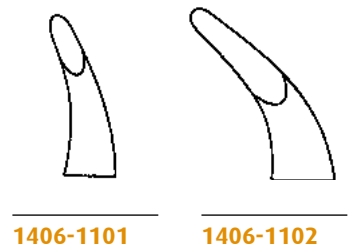
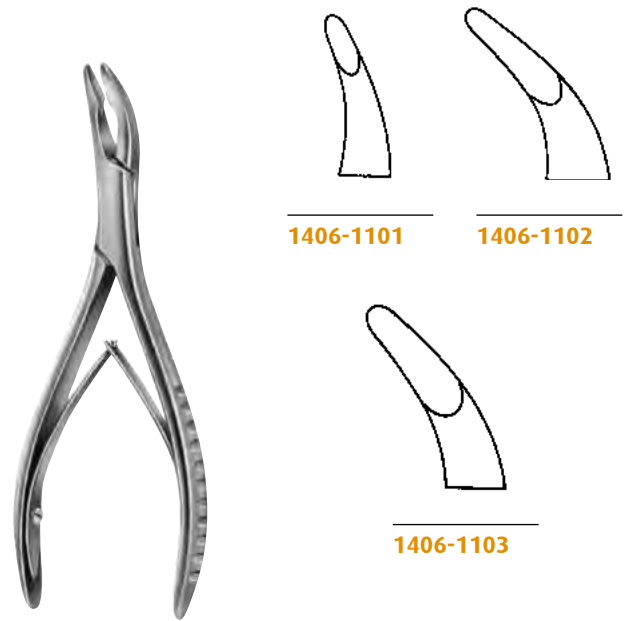

LUER

1406-1101 - 1406-1103

14,5 cm / 5 3/4"

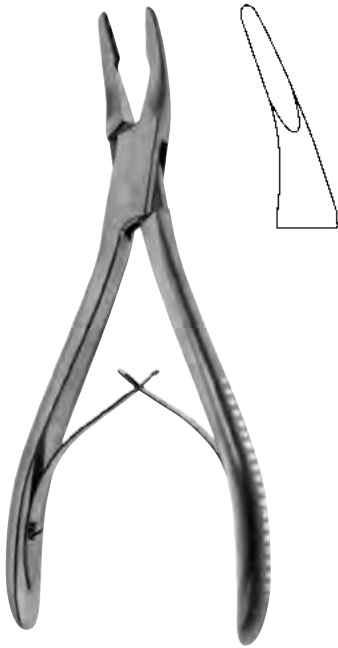

BEYER
1406-2518 18,0 cm / 7"

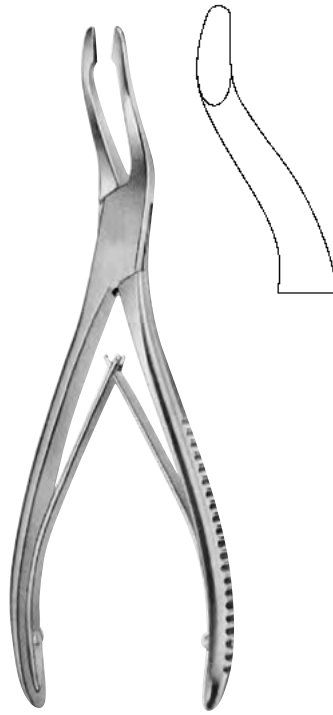

JANSEN
1406-1719 19,0 cm / 7 1/2"

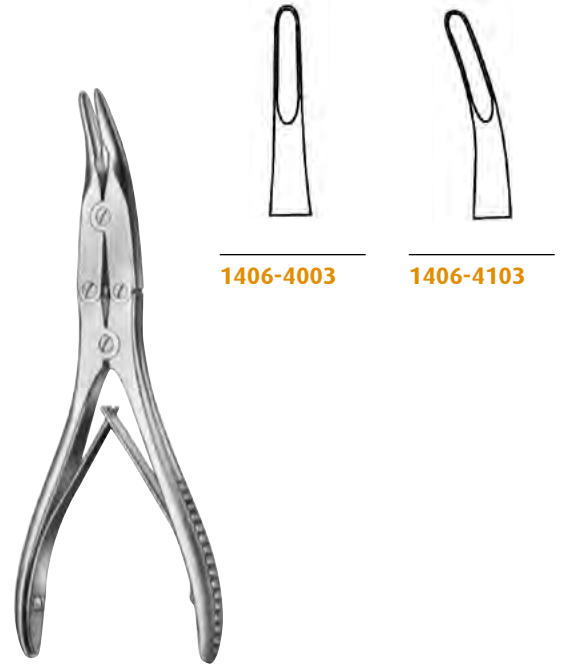

BÖHLER
1406-4003 - 1406-4103 15,5 cm / 6"



BEYER
1406-4918 18,0 cm / 7"



ZAUHAL-JANSEN
1406-5118 18,0 cm / 7"



MAYFIELD
1406-4517 17,5 cm / 7"

Hohlmeißelzangen
Bone Rongeurs
Pinzas-gubias
Pinze per ossa

024



MARQUARDT
1406-4730 20,0 cm / 8"



RUSKIN
1406-5305 18,0 cm / 7"



RUSKIN
1406-5505 24,0 cm / 9½"

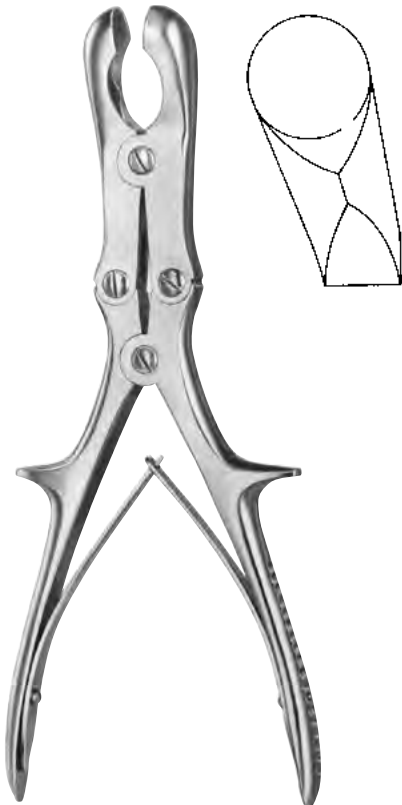

SEMB
1407-2124 23,5 cm / 9¼"



STILLE
1406-6004 - 1406-6008 23,0 cm / 9"

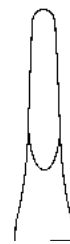

1406-6004



1406-6006

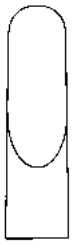

1406-6008

2,0 mm

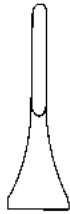

1406-5802

3,0 mm



1406-5803

4,0 mm



1406-5804



ECHLIN

1406-5802 - 1406-5804

23,0 cm / 9"



STILLE RUSKIN

1406-6324

23,0 cm / 9"

3,0 mm



1406-6203

5,0 mm



1406-6205

8,0 mm



1406-6208

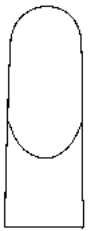

1406-6422

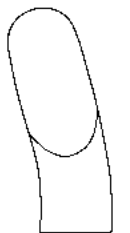

1406-6522



LEKSELL-STILLE

1406-6203 - 1406-6208

24,5 cm / 9³/₄"

FRYKHOLM

1406-5924

24,5 cm / 9³/₄"

STILLE-LUER

1406-6422 - 1406-6522

22,0 cm / 8³/₄"

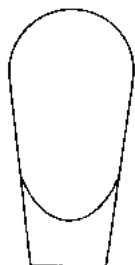

1406-6423
 1406-6627

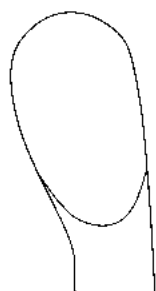

1406-6523
 1406-6727



STILLE-LUER

1406-6423 – 1406-6523
 1406-6627 – 1406-6727

23,0 cm / 9"
 27,0 cm / 10³/₄"



1406-7001



1406-7002



SAUERBRUCH

1406-7001 – 1406-7002

30,0 cm / 11³/₄"

Knochensplitterzangen
Bone Cutting Forceps
Pinzas cortantes para huesos
Cesoie per ossa

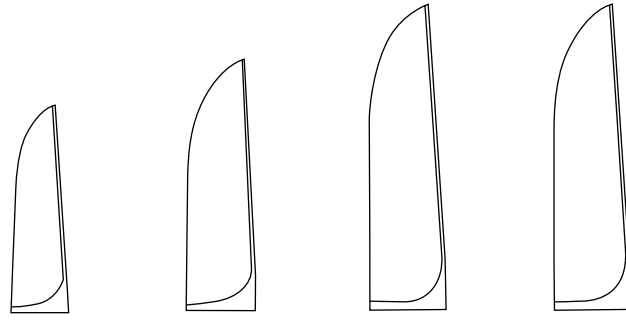

1407-0614

1407-0617

1407-0620

1407-0622

LISTON

1407-0614	14,0 cm / 5 1/2"
1407-0617	17,0 cm / 6 3/4"
1407-0620	19,0 cm / 7 1/2"
1407-0622	22,0 cm / 8 3/4"

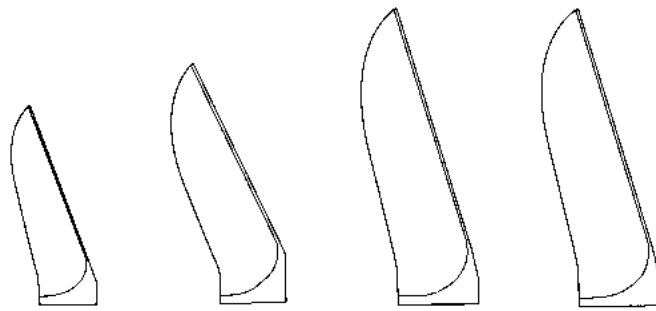

1407-0714

1407-0717

1407-0719

1407-0722

LISTON

1407-0714	14,0 cm / 5 1/2"
1407-0717	17,0 cm / 6 3/4"
1407-0719	19,0 cm / 7 1/2"
1407-0722	22,0 cm / 8 3/4"



MARKWALDER

1406-6919 20,0 cm / 8"



COTTLE-KAZANJIAN

1407-0419 19,0 cm / 7½"



CLEVELAND

1407-0115 15,0 cm / 6"

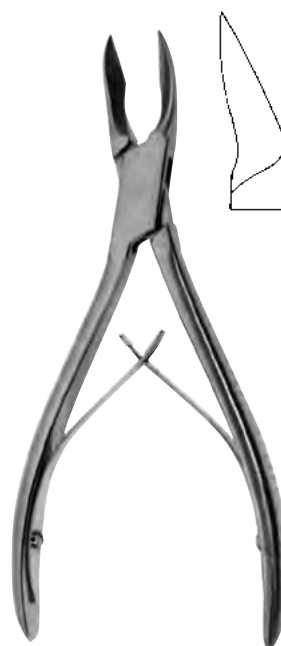

CLEVELAND

1407-0117 17,0 cm / 6¾"

Knochensplitterzangen
Bone Cutting Forceps
Pinzas cortantes para huesos
Cesoie per ossa

024



BÖHLER

1407-0815 15,0 cm / 6"



BÖHLER

1407-0915 15,0 cm / 6"



RUSKIN

1407-1219 18,0 cm / 7"



RUSKIN

1407-1319 18,0 cm / 7"



MC INDOE

1407-1118 17,5 cm / 6³/₄"



STILLE-LISTON

1407-1727 27,0 cm / 10³/₄"



STILLE-LISTON

1407-1428 27,0 cm / 10³/₄"

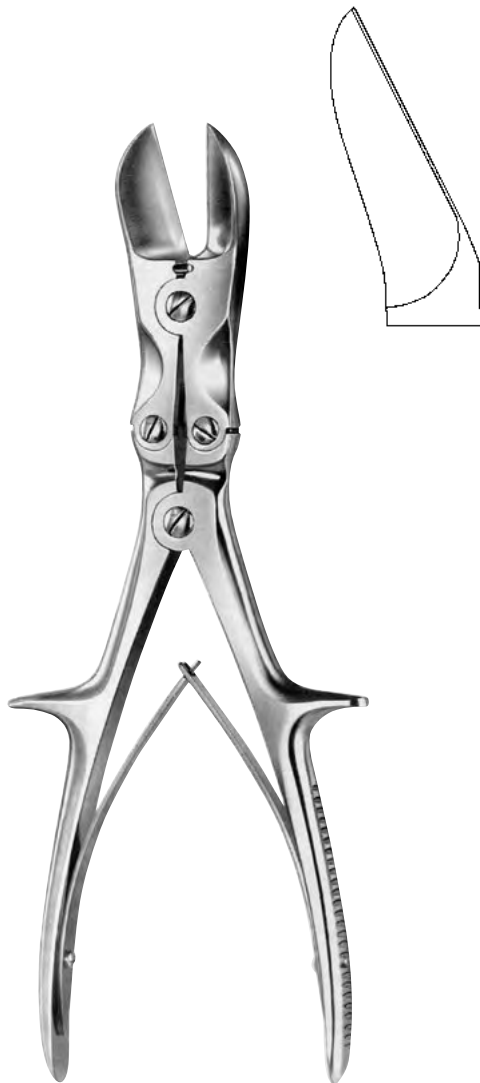

STILLE-LISTON

1407-1524 24,0 cm / 9¹/₂"



STILLE-LISTON

1407-1528 27,0 cm / 10³/₄"



LISTON-KEY

1407-1927 27,0 cm / 10³/₄"



SEMB

1406-6924 24,0 cm / 9¹/₂"



Bleihände. Durch Umbiegen der Lappen werden Hand und Finger in Operationslage festgehalten und durch das Gewicht der Bleihand zusätzlich immobilisiert.

Lead hands. Hand and fingers are secured by bending the lateral fixation process and further fixed by weight of lead hand.

Manos de plomo. Doblando los lóbulos se sujeta la mano y los dedos en posición para operar y además se queda inmóvil por el peso de la mano de plomo.

Mano di piombo. Legando i lobi, la mano e le dita si assestano in posizione da poter operare grazie al peso della mano di piombo.

1472-1400 24,5 cm / 9³/₄"
für Kinder
for children
para niños
per bambine

1472-1200 37,0 cm /
14¹/₂"
für Erwachsene
for adults
para adultos
per adulti



Zur schnellen und sicheren Fixierung der Hand.

To hold the hand quickly and efficiently in any desired position.

Para mantener la mano en cualquier posición deseada, eficiente y rápidamente.

Per una rapida e sicura fissazione alla mano in qualsiasi posizione desiderata.

MARTIN-VICKERS

1472-1600 27,0 cm / 10³/₄"



1472-1100

Band allein
Band only
Tomo solo
Nastro solo

FELDHEIM

1472-1000 10,0 cm / 4"

Nagelbohrer
finger nail drill
Taladro para uñas
Ghiaccia unghie

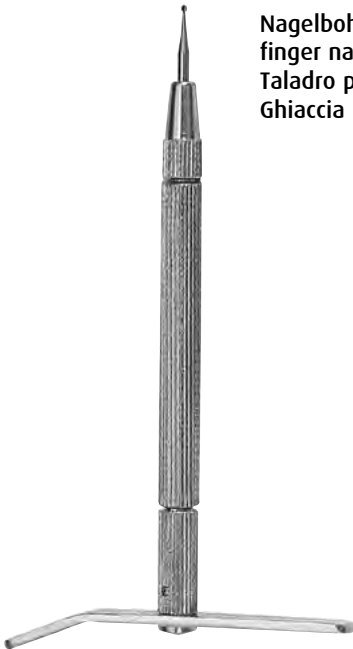

MARTIN-IDEAL

1472-1001
komplett
complet
completo
completo



1472-1002



1472-1003



1472-1004

MARTIN-IDEAL

1472-1005
Satz mit 3 Bohrern
Set of 3 drills
Juego de 3 brocas
Set con 3 punte

Fingerringsägen, Nagelextraktionszangen
Finger Ring Saws, Nail Extracting Forceps
Sierras para abrir anillos, Pinzas para arrancar uñas
Seghe per anelli, Pinze per la lacerazione delle unghie



1401-3701
 Ersatzsägeblatt
 Spare saw black
 Hoja de repuesto para sierra
 Lame di ricambio per sega

MOD. MARTIN

1401-3700 17,0 cm / 6³/₄"



1401-3801
 Ersatzsägeblatt
 Spare saw black
 Hoja de repuesto para sierra
 Lame di ricambio per sega

WALTON

1401-3800 16,0 cm / 6¹/₄"



1401-3901
 Ersatzsägeblatt
 Spare saw black
 Hoja de repuesto para sierra
 Lame di ricambio per sega

1401-3900 17,0 cm / 6³/₄"



RADOLF

1500-3013 13,5 cm / 5³/₈"

025

**Thorax, Cardiovascular-Chirurgie
Thorax, Cardiovascular Surgery
Toráció, Cirugía cardiovascular
Torace, Chirurgia cardiovascolare**

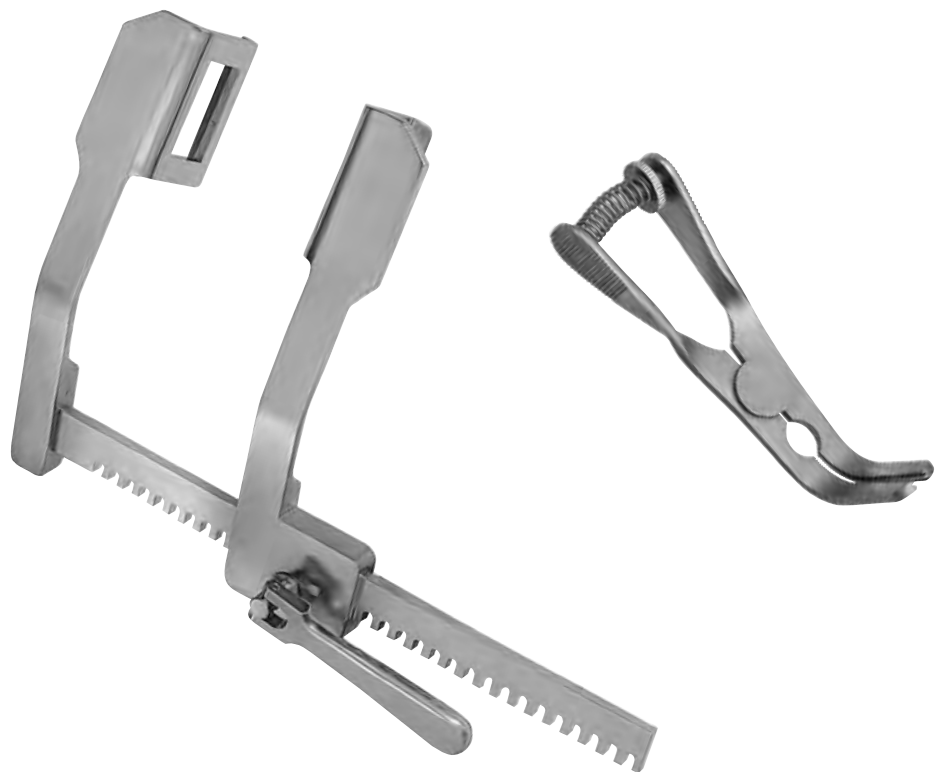



1301-0023 23,0 cm / 9"



1301-0122 23,0 cm / 9"



GLUCK
1301-0322 22,0 cm / 8"



SAUERBRUCH
1301-1027 26,0 cm / 10³/₄"



GIERTZ-STILLE
1301-1727 27,0 cm / 10³/₄"

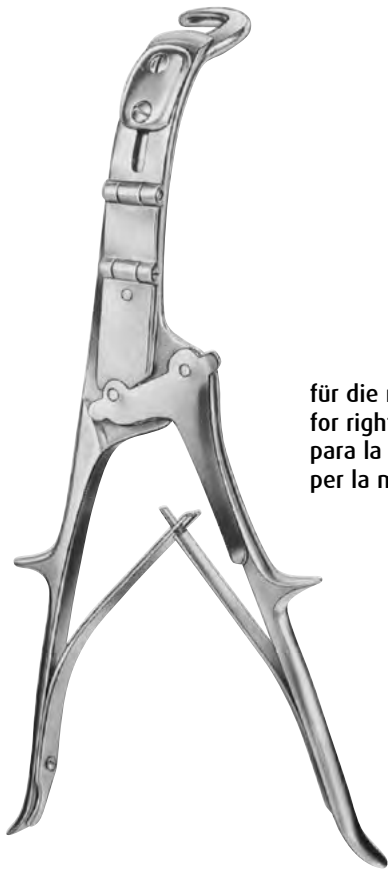

für die rechte Hand
for right hand
para la mano derecha
per la mano destra

BRUNNER

1301-1328 32,0 cm / 12¹/₂"

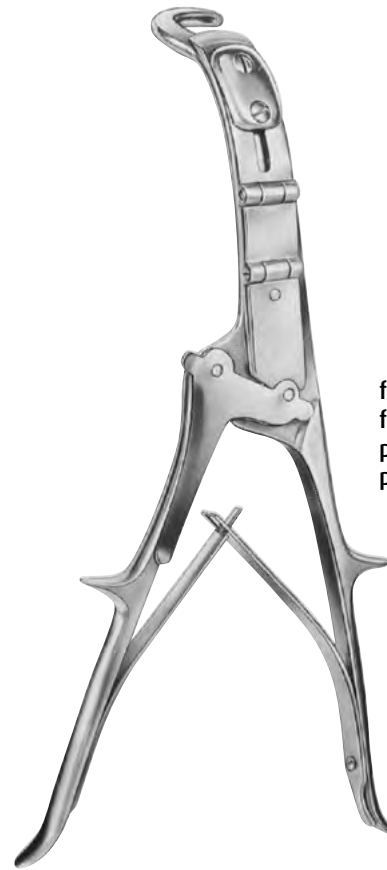

für die linke Hand
for left hand
para la mano izquierda
per la mano sinistra

BRUNNER

1301-1528 32,0 cm / 12¹/₂"



BETHUNE

1301-1134 34,0 cm / 13³/₄"



LEBSCHE

1301-0924 24,5 cm / 10"

ALUMINIUM

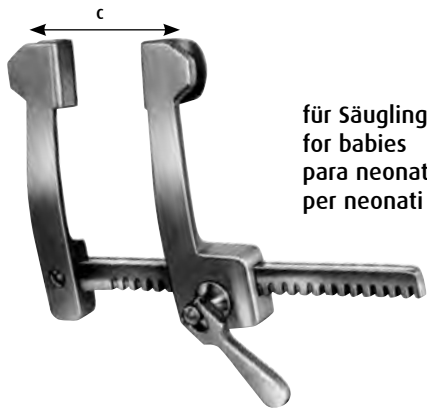
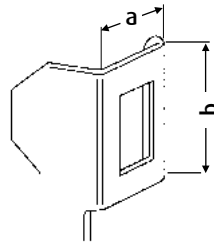

für Säuglinge
 for babies
 para neonatales
 per neonati

COOLEY	a x b	c
1302-0100	12 x 16 mm	85 mm



für Kinder
 for children
 para niños
 per bambini

COOLEY	a x b	c
1302-0200	15 x 30 mm	115 mm



für Erwachsene
 for adults
 para adultos
 per adulti

COOLEY	a x b	c
1302-0300	20 x 45 mm	140 mm
1302-0400	35 x 50 mm	185 mm

ALUMINIUM

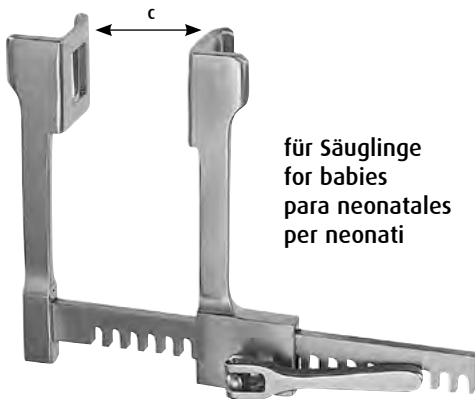

für Säuglinge
for babies
para neonatales
per neonati

FINOCHIETTO INFANT	a x b	c
1302-5000	15 x 15 mm	75 mm



für Kinder
for children
para niños
per bambini

FINOCHIETTO BABY	a x b	c
1302-0600	31 x 31 mm	100 mm

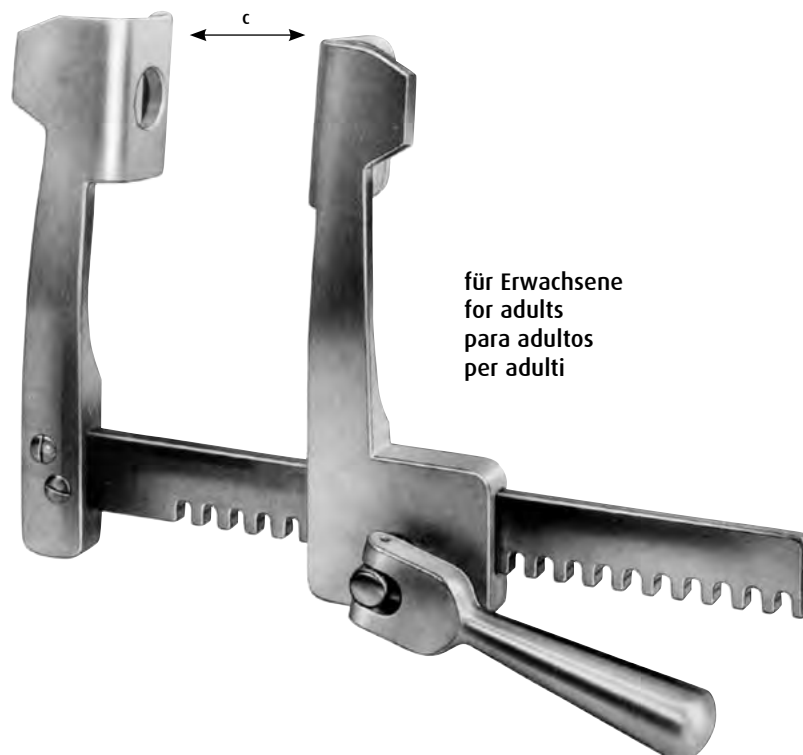

für Erwachsene
for adults
para adultos
per adulti

FINOCHIETTO	a x b	c
1302-0700	40 x 45 mm	135 mm
1302-0800	52 x 62 mm	175 mm
1302-0900	85 x 65 mm	175 mm

ALUMINIUM

1302-2210 34 x 42 mm

Ersatzvalven, Paar
 Spare blades, pair
 Valvas de recambio, par
 Valve di ricambio, paio

1302-2211 48 x 42 mm

Ersatzvalven, Paar
 Spare blades, pair
 Valvas de recambio, par
 Valve di ricambio, paio

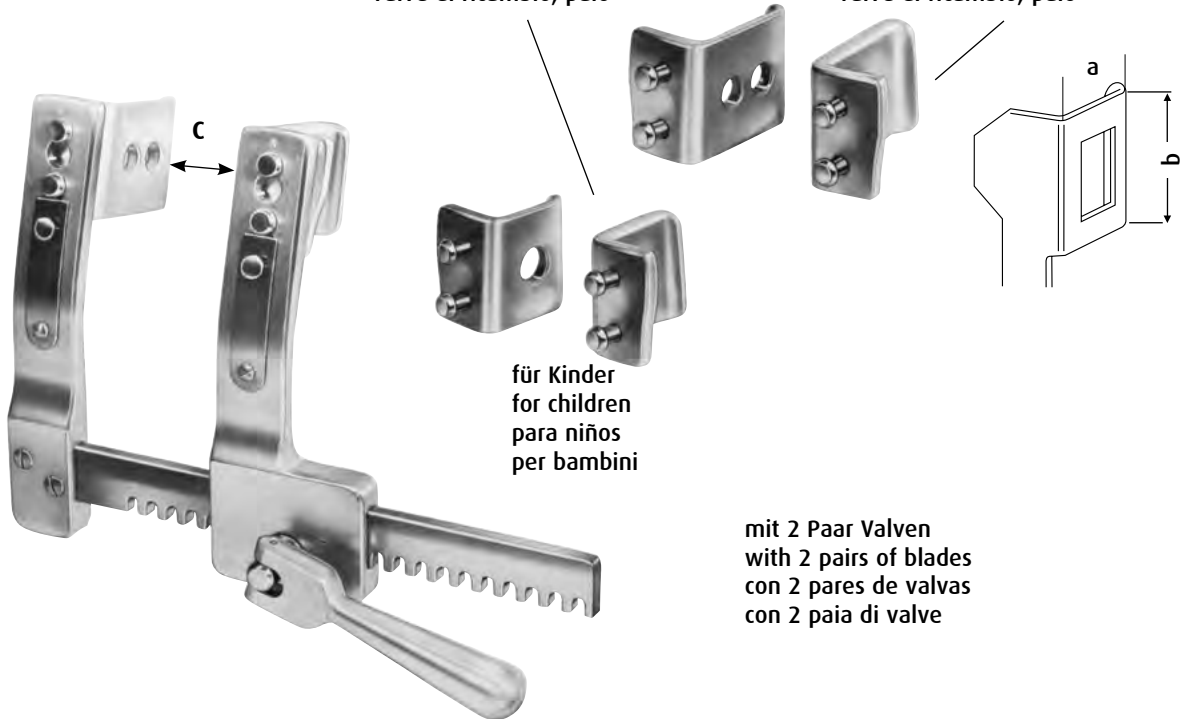

für Kinder
 for children
 para niños
 per bambini

mit 2 Paar Valven
 with 2 pairs of blades
 con 2 pares de valvas
 con 2 paia di valve

BURFORD

a x b

c

1302-2200

48 x 42 mm + 34 x 42 mm

135 mm

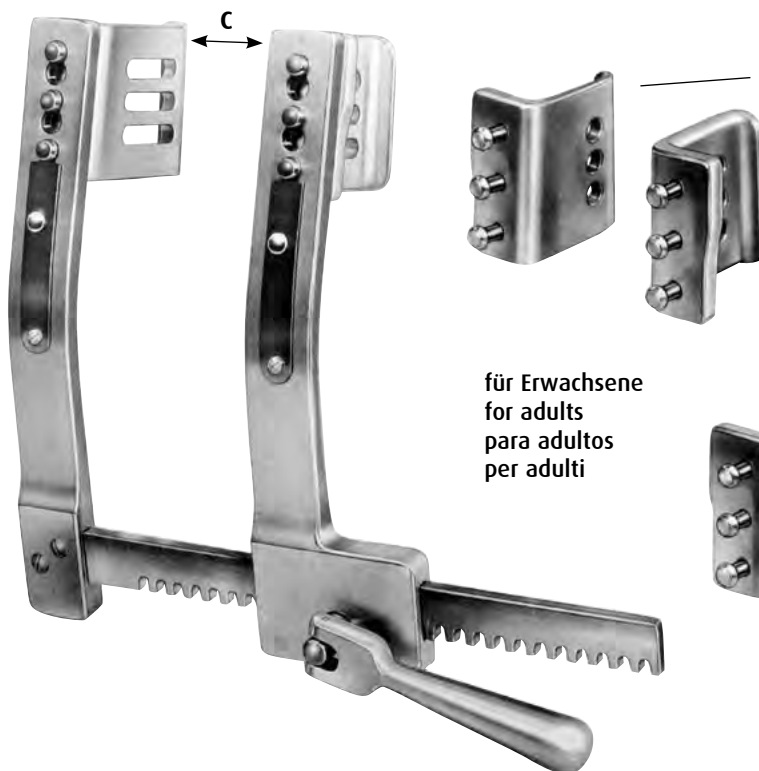

für Erwachsene
 for adults
 para adultos
 per adulti

1302-2510 47 x 62 mm

Ersatzvalven, Paar
 Spare blades, pair
 Valvas de recambio, par
 Valve di ricambio paio

1302-2511 65 x 62 mm

Ersatzvalven, Paar
 Spare blades, pair
 Valvas de recambio, par
 Valve di ricambio paio

mit 2 Paar Valven
 with 2 pairs of blades
 con 2 pares de valvas
 con 2 paia di valve

BURFORD

a x b

c

1302-2300

47 x 62 mm + 65 x 62 mm

200 mm

1302-2400

47 x 62 mm + 65 x 62 mm

260 mm

1302-2500

47 x 62 mm + 65 x 62 mm

300 mm

ALUMINIUM

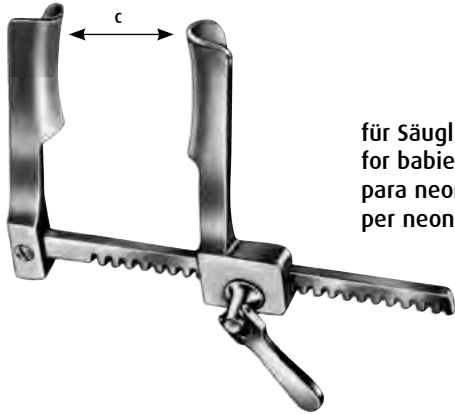
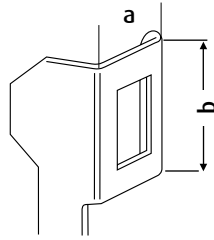

für Säuglinge
 for babies
 para neonatales
 per neonati

CASTAÑEDA	a x b	c
1302-1100	10,5 x 32 mm	65 mm



für Kleinkinder
 for infants
 para bebes
 per piccoli

CASTAÑEDA	a x b	c
1302-1200	12 x 45 mm	70 mm

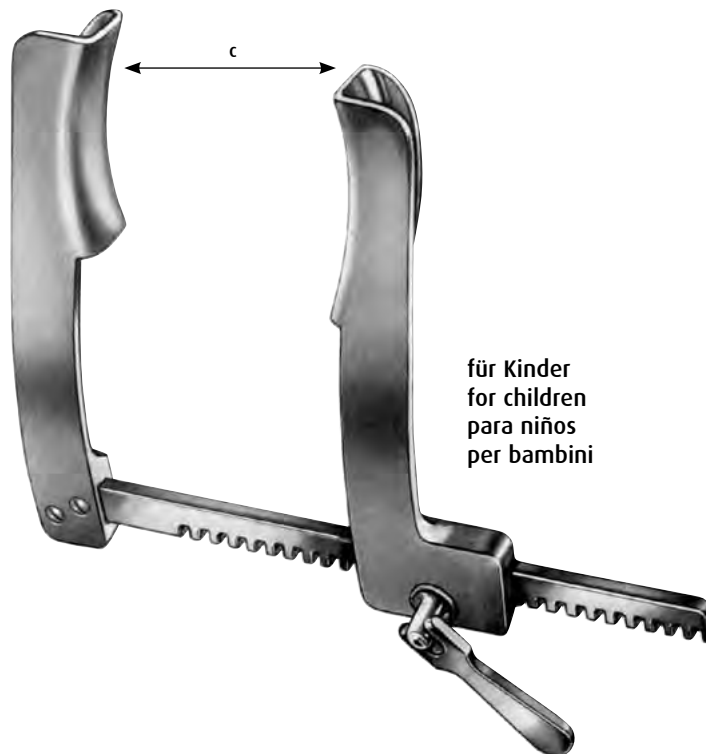

für Kinder
 for children
 para niños
 per bambini

CASTAÑEDA	a x b	c
1302-1300	15 x 60 mm	120 mm

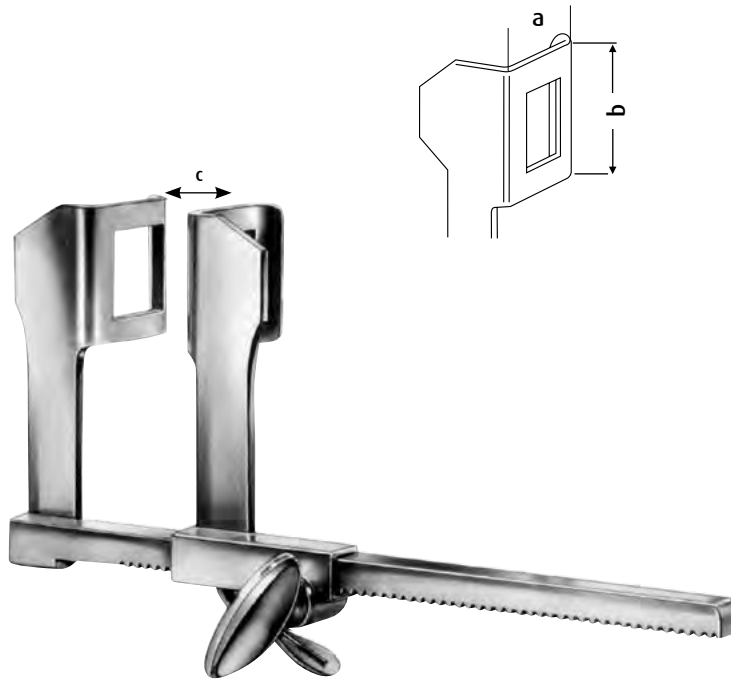

HAIGHT	a x b	c
1302-3300	30 x 30 mm	120 mm



TUFFIER	a x b	c
1302-3100	45 x 45 mm	160 mm

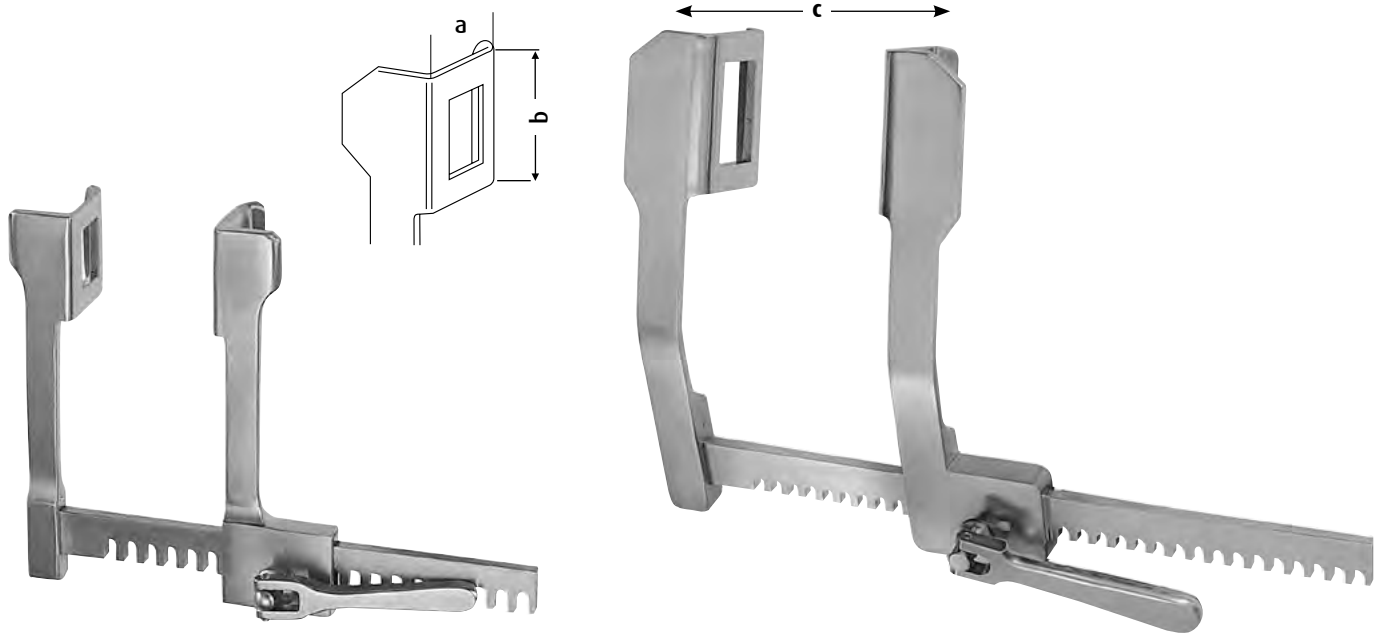

FINOCHIETTO BABY	a x b	c
1302-0500	14 x 15 mm	75 mm

FINOCHIETTO	a x b	c
1302-0501	40 x 40 mm	165 mm
1302-0502	45 x 65 mm	200 mm
1302-0503	70 x 65 mm	250 mm



ALUMINIUM

FINOCHIETTO (MODIF.)	a x b	c
1302-1000	14 x 15 mm	120 mm

Rippensperrer
Rib Retractors
Separadores costales
Divaricatori costali

025

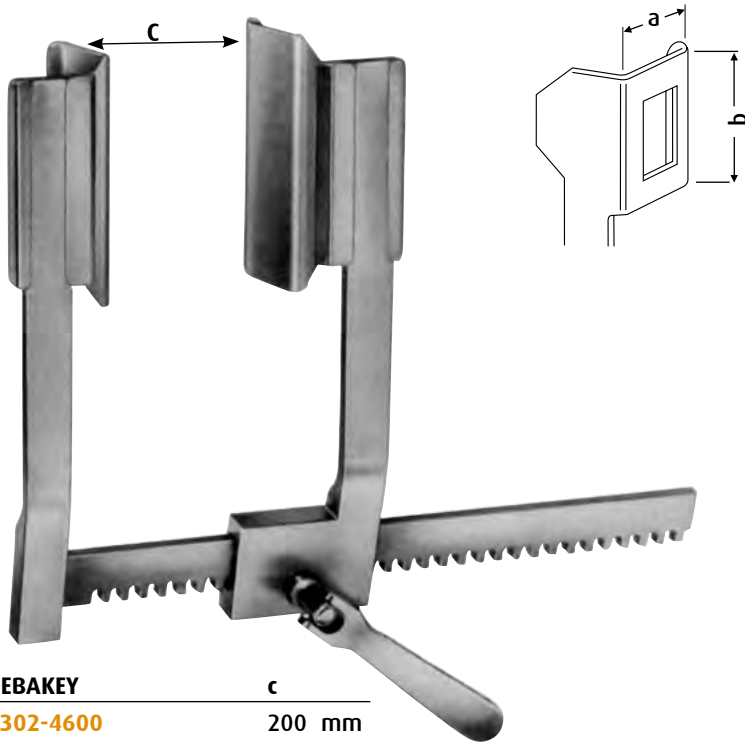

DEBAKEY

025-200-002

Sperrer allein
 Retractor only
 Separador suelto
 Divaricatore solo

DEBAKEY
1302-4600 **c**
 200 mm



1302-4603 60 x 60 mm

1302-4604 50 x 80 mm

1302-4605 40 x 100 mm



1302-4606 80 x 60 mm



1302-4602 50 x 66 mm

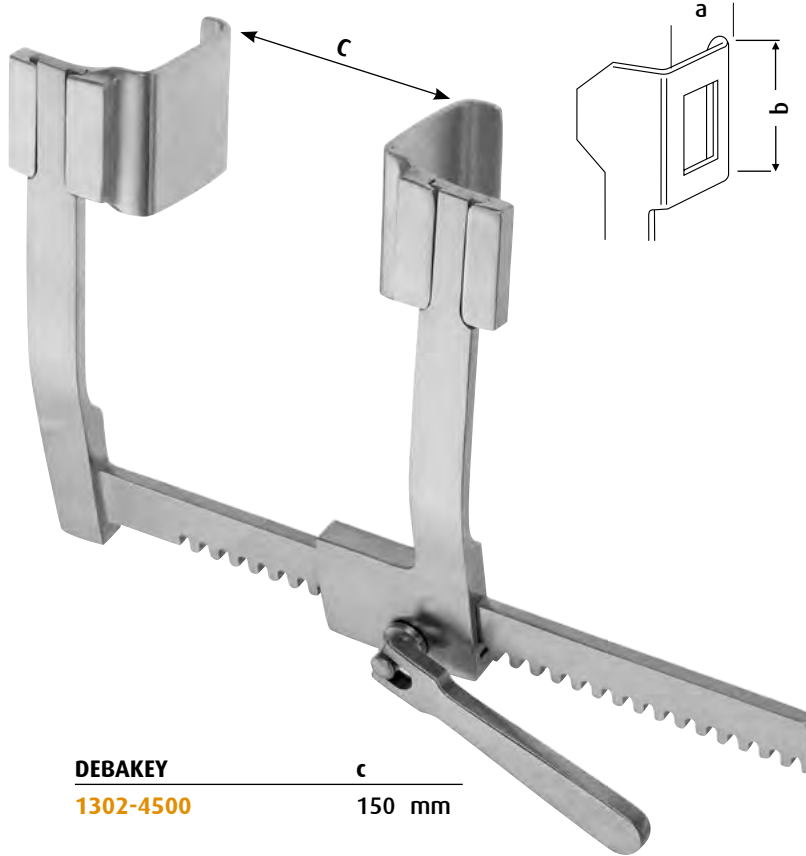

DEBAKEY

1302-4501

Sperrer allein
Retractor only
Separador suelto
Divaricatore solo

DEBAKEY c
1302-4500 150 mm



1302-4503 30 x 30 mm



1302-4504 40 x 40 mm



1302-4505 50 x 50 mm

Sternumspreizer
Sternal Retractors
Separadores esternos
Divaricatori per sterno

025

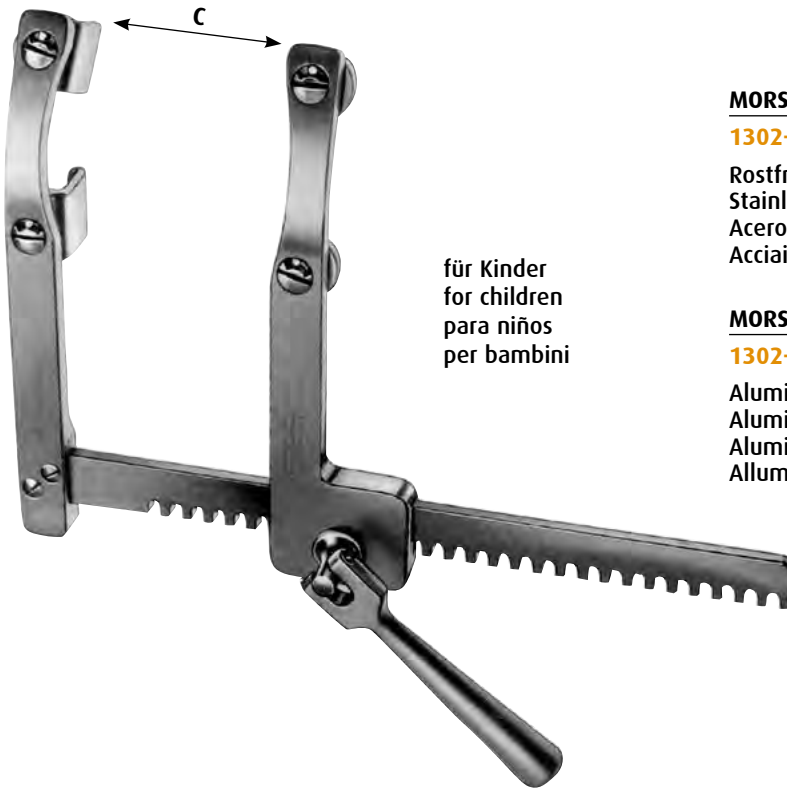

für Kinder
for children
para niños
per bambini

MORSE-FAVALORO	a x b	c
1302-2800	17 x 22 mm	160 mm

Rostfreier Stahl
Stainless Steel
Acero inoxidable
Acciaio inossidabile

MORSE-FAVALORO	a x b	c
1302-2801	17 x 22 mm	160 mm

Aluminium
Aluminium
Aluminio
Alluminio

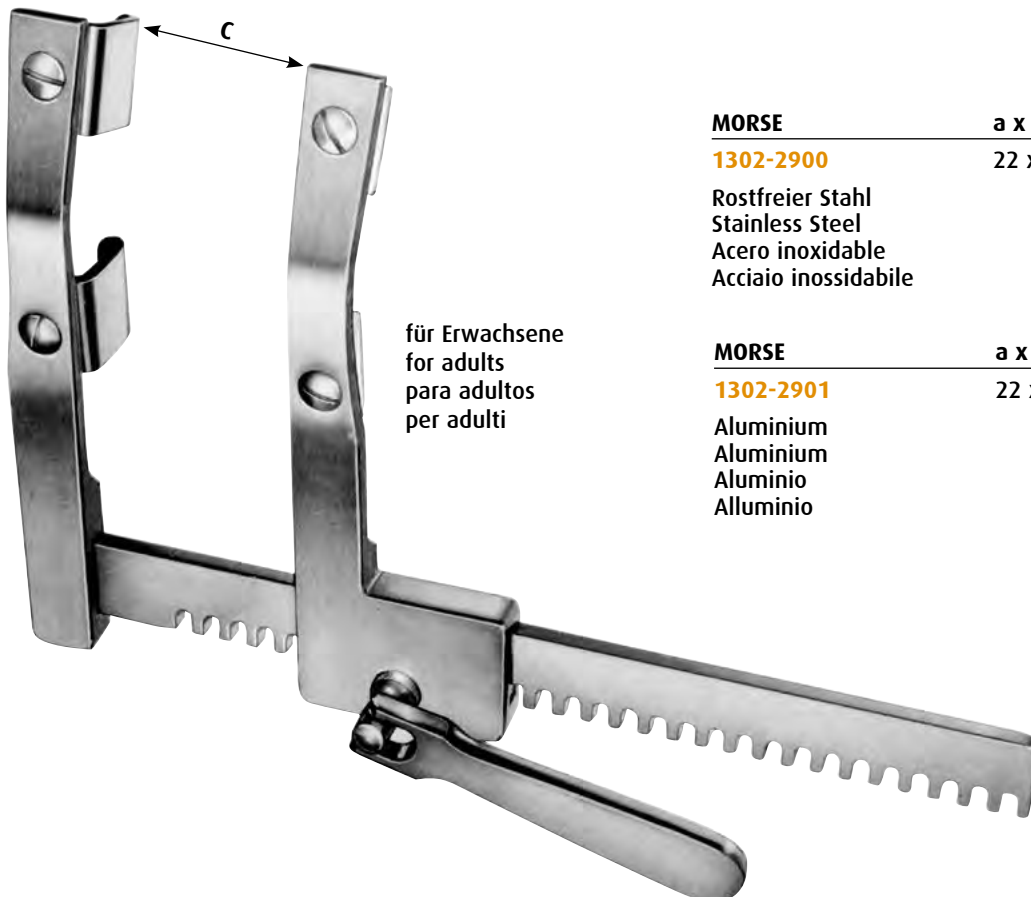

für Erwachsene
for adults
para adultos
per adulti

MORSE	a x b	c
1302-2900	22 x 27 mm	200 mm

Rostfreier Stahl
Stainless Steel
Acero inoxidable
Acciaio inossidabile

MORSE	a x b	c
1302-2901	22 x 27 mm	200 mm

Aluminium
Aluminium
Aluminio
Alluminio

025

Thoraxsperrer
Thoracic Retractor
Separador torácico
Divaricatore per il torace



MERCEDES

1302-5100

komplett
complete
completo
completo

MERCEDES

1302-5101

Sperrer allein
Retractor only
Separador suelto
Divaricatore solo



1302-5102

48 x 68 mm



1302-5103

70 x 75 mm



BABY-BAILEY

1302-6214 15,5 cm / 6"



BAILEY

1302-6316 20,0 cm / 8"



BAILEY-GIBBON

1302-6416 20,0 cm / 8"



ALLISON

1303-0126	30,0 cm / 11 ³ / ₄ "	40 mm
1303-0132	32,0 cm / 12 ¹ / ₂ "	54 mm



PRICE-THOMAS

1303-1322	22,0 cm / 8 ³ / ₄ "
-----------	-------------------------------------------



PRICE-THOMAS

1303-1522 - 1303-1722	22,0 cm / 8 ³ / ₄ "
-----------------------	-------------------------------------------

1303-1522

1303-1722

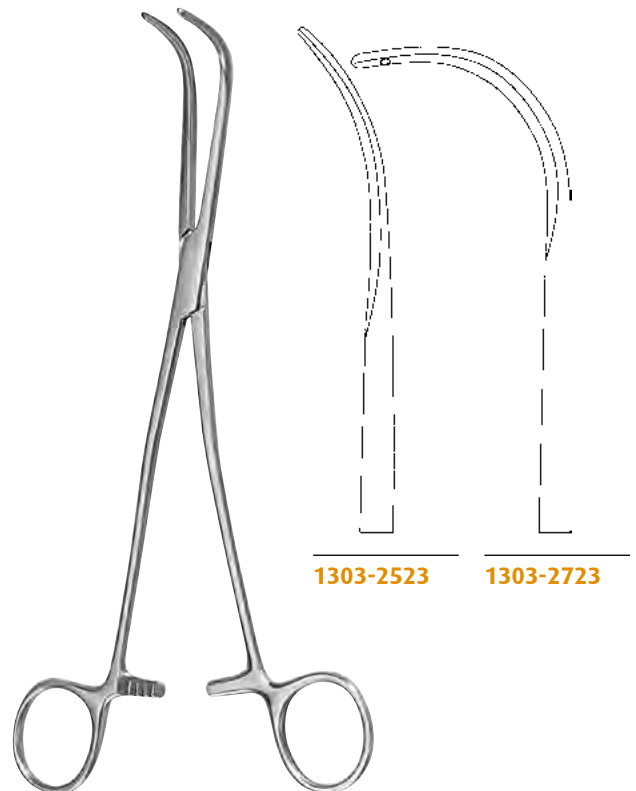

SEMB

1303-2523 - 1303-2723	24,0 cm / 9 ¹ / ₂ "
-----------------------	-------------------------------------------

1303-2523

1303-2723

Lungenfaßzangen
Lung Grasping Forceps
Pinzas para coger el pulmón
Pinze per afferrare polmone

025

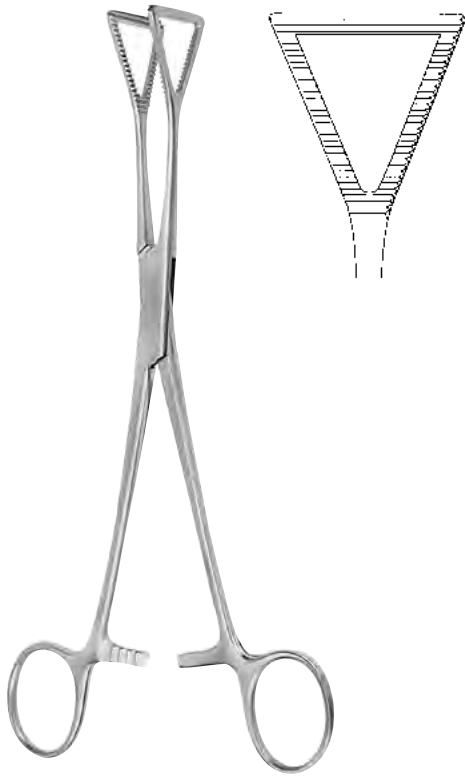

LOVELACE
1303-1020 20,0 cm / 8"

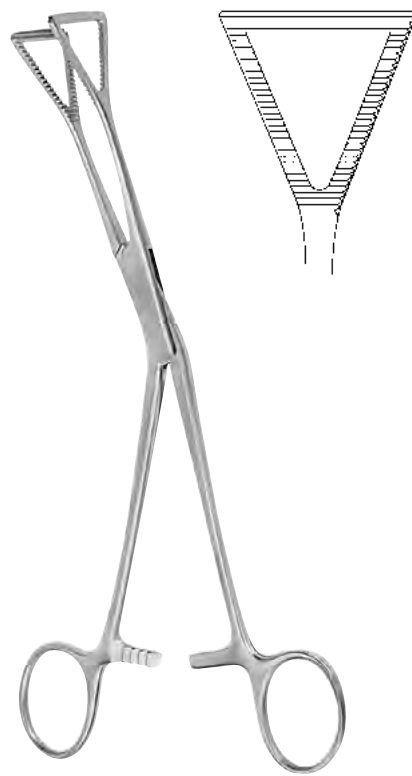

LOVELACE
1303-1120 20,0 cm / 8"

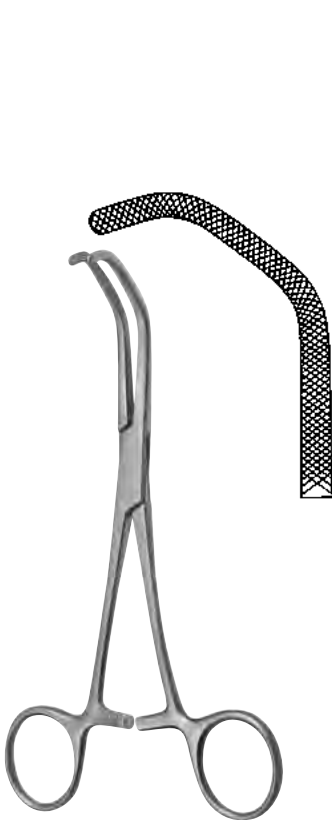

BABY-SATINSKY
1156-9015 15,0 cm / 6"

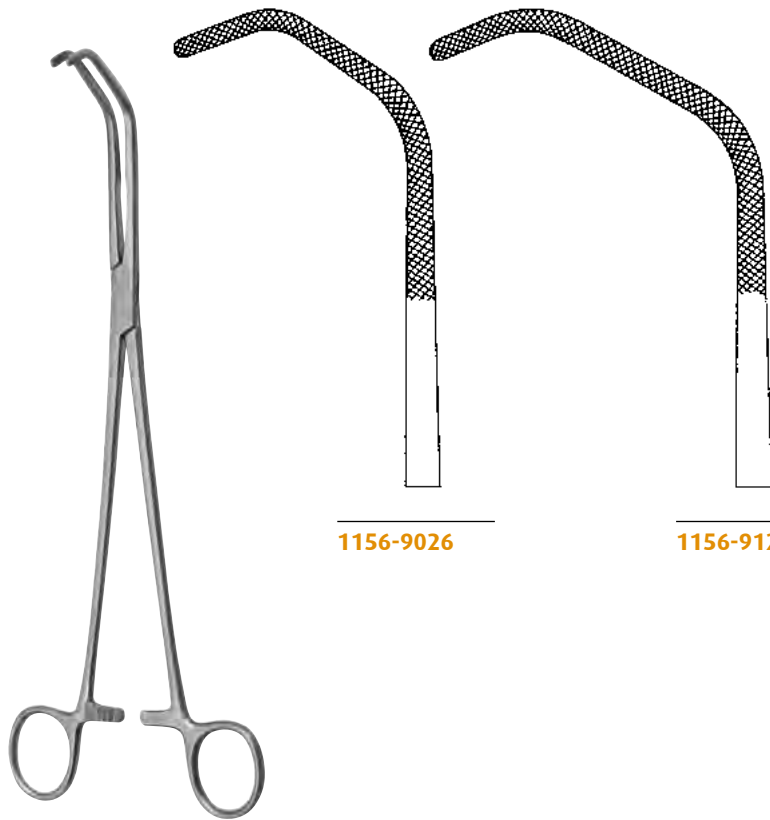

1156-9026

1156-9126

SATINSKY
1156-9026 - 1156-9126 26,5 cm / 10¹/₂"

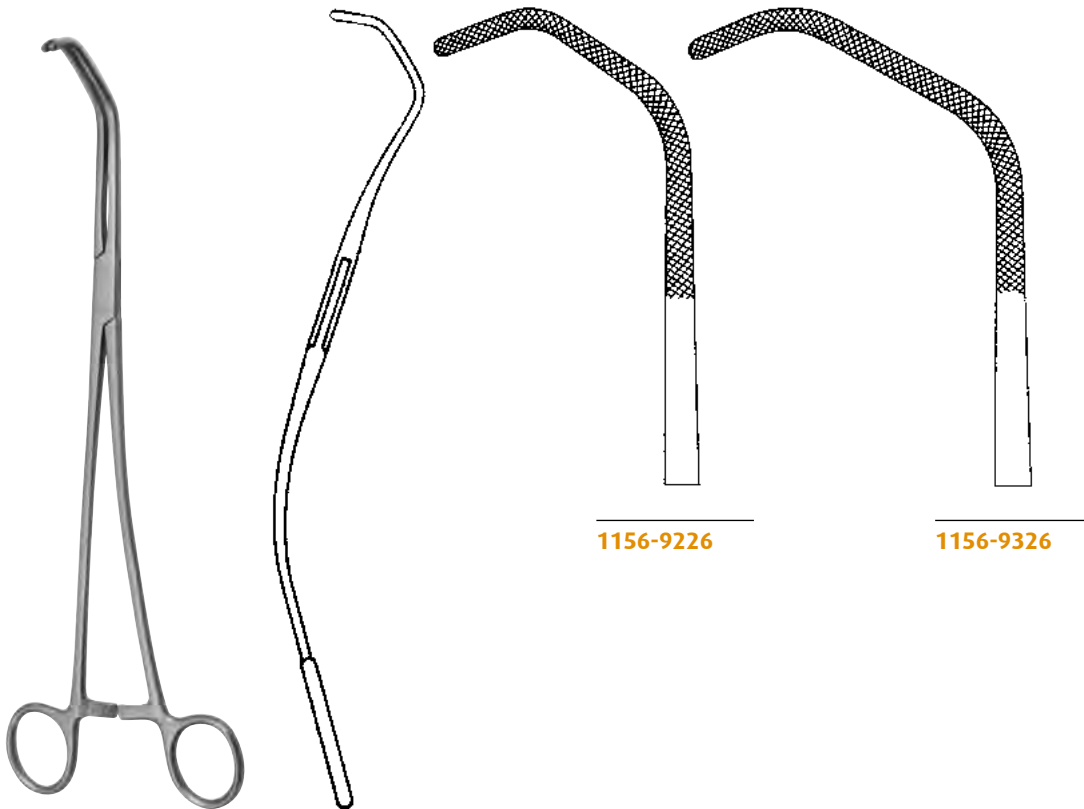

1156-9226

1156-9326

SATINSKY

1156-9226 - 1156-9326

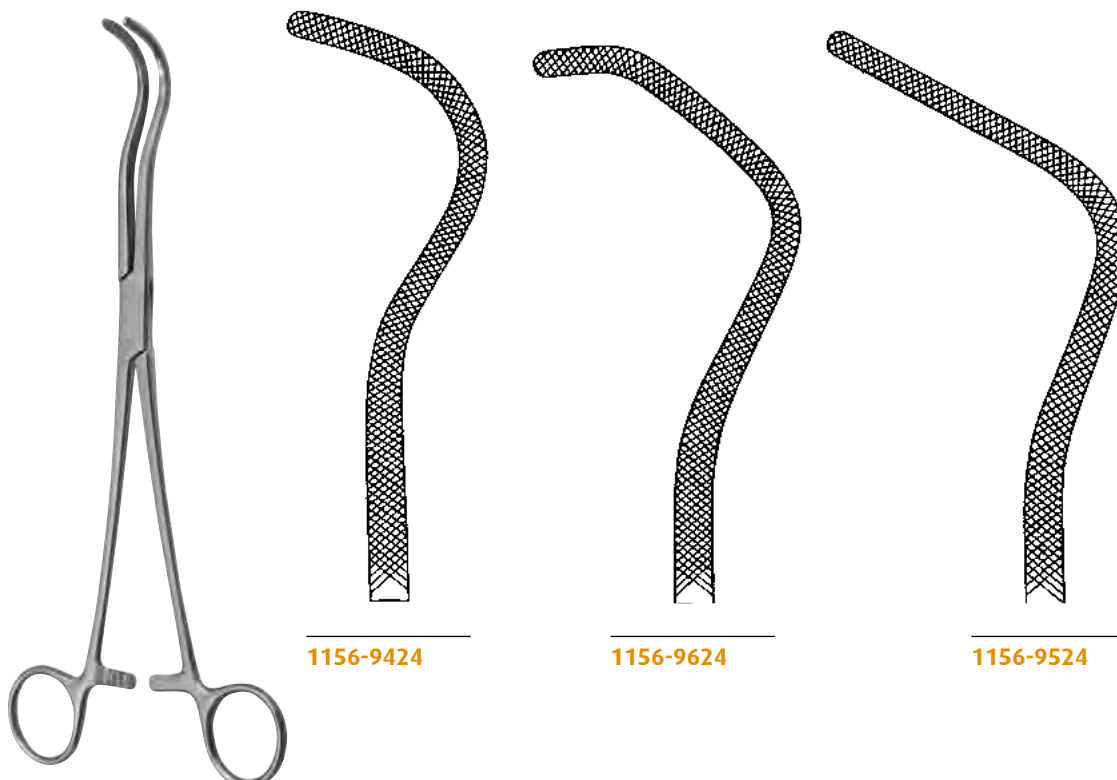
26,5 cm / 10¹/₂"

1156-9424

1156-9624

1156-9524

HARKEN

1156-9424 - 1156-9524

24,0 cm / 9¹/₂"

ATRAUMA

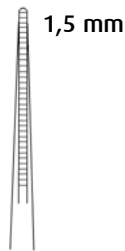

1132-1016	16,0 cm / 6 ¹ / ₄ "
1132-1020	20,0 cm / 8"
1132-1024	24,0 cm / 9 ¹ / ₂ "

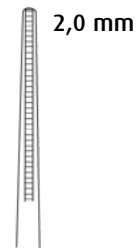

1132-0816	16,0 cm / 6 ¹ / ₄ "
1132-0820	20,0 cm / 8"
1132-0824	24,0 cm / 9 ¹ / ₂ "
1132-0830	30,0 cm / 12"

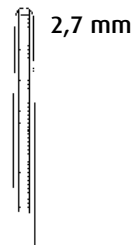

1132-0416	16,0 cm / 6 ¹ / ₄ "
1132-0420	20,0 cm / 8"
1132-0424	24,0 cm / 9 ¹ / ₂ "
1132-0430	30,0 cm / 12"

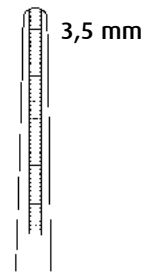

1132-0016	16,0 cm / 6 ¹ / ₄ "
1132-0220	20,0 cm / 8"
1132-0024	24,0 cm / 9 ¹ / ₂ "
1132-0030	30,0 cm / 12"

DEBAKEY

1132-1016 - 1132-0030

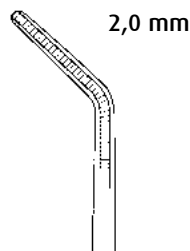

1132-0916	16,0 cm / 6 ¹ / ₄ "
1132-0920	20,0 cm / 8"
1132-0924	24,0 cm / 9 ¹ / ₂ "
1132-0930	30,0 cm / 12"

DEBAKEY

1132-0916 - 1132-0930

ATRAUMA



DEBAKEY

- 1154-9408**
- 1154-9409**
- 1154-9410**
- 1154-9412**

7,5 cm / 3"
 8,5 cm / 3¹/₄"
 10,5 cm / 4¹/₈"
 12,0 cm / 4³/₄"

L

2,5 cm / 1"
 3,5 cm / 1³/₈"
 5,0 cm / 2"
 6,8 cm / 2³/₄"



DEBAKEY

- 1154-9508**
- 1154-9509**
- 1154-9510**
- 1154-9511**

7,0 cm / 2³/₄"
 8,0 cm / 3¹/₈"
 10,0 cm / 3³/₄"
 11,5 cm / 4¹/₄"

L

2,5 cm / 1"
 3,5 cm / 1³/₈"
 5,0 cm / 2"
 6,8 cm / 2³/₄"

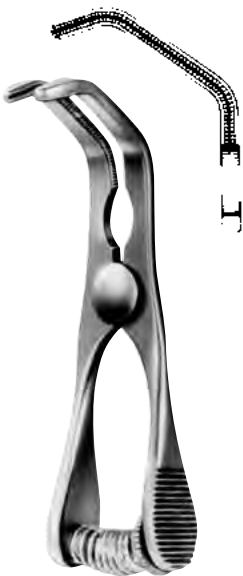

DEBAKEY-SATINSKY

- 1155-3907**

7,0 cm / 2³/₄"



DEBAKEY-SATINSKY

- 1155-3909**

9,0 cm / 3¹/₂"



DEBAKEY-SATINSKY

- 1155-3910**

10,0 cm / 4"

ATRAUMA



1155-0724 23,5 cm / 9¹/₄"



GLOVER

- | | |
|------------------|-------------------------------------------|
| 1154-9606 | 6,0 cm / 2 ³ / ₈ " |
| 1154-9607 | 7,0 cm / 2 ³ / ₄ " |
| 1154-9610 | 9,0 cm / 3 ³ / ₄ " |
| 1154-9612 | 11,0 cm / 4 ³ / ₈ " |



GLOVER

- | | |
|------------------|-------------------------------------------|
| 1154-9706 | 5,5 cm / 2 ¹ / ₃ " |
| 1154-9707 | 7,0 cm / 2 ¹ / ₂ " |
| 1154-9709 | 8,5 cm / 3 ¹ / ₂ " |
| 1154-9711 | 10,5 cm / 4 ³ / ₈ " |

ATRAUMA



GLOVER

1155-3105

6,0 cm / 2 1/4"



SANTULLI

1155-3307

7,0 cm / 2 3/4"



1155-3509

1155-3511

Carotisklemme
 Carotid Clamp
 Clamp para carotis
 Pinze carotis

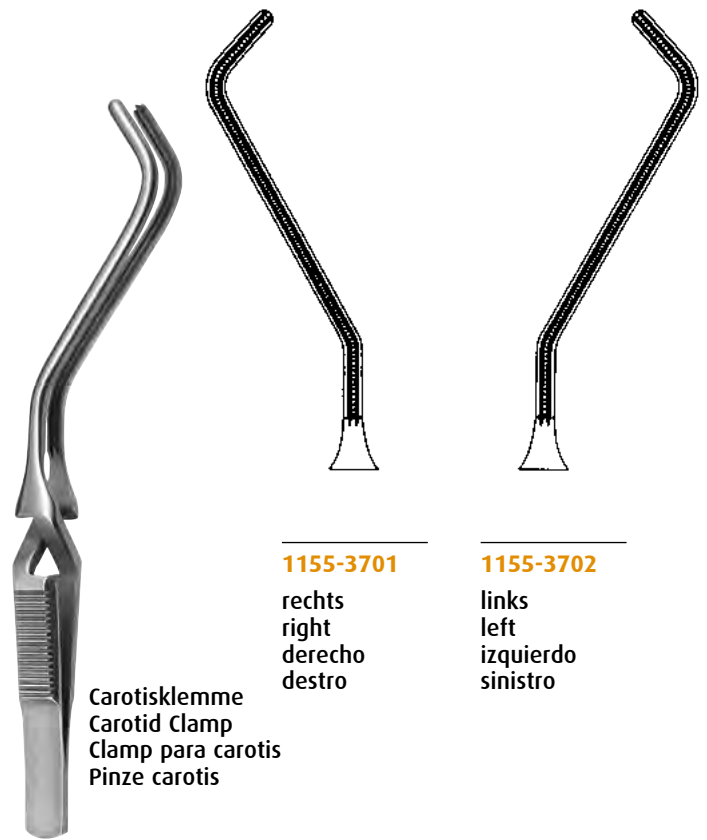

1155-3701

rechts
 right
 derecho
 destro

1155-3702

links
 left
 izquierdo
 sinistro

Carotisklemme
 Carotid Clamp
 Clamp para carotis
 Pinze carotis

GREGORY SOFT

1155-3509 9,0 cm / 3 1/2"

1155-3511 11,0 cm / 4 1/4"

GREGORY

1155-3701 - 1155-3702

10,5 cm / 4"

ATRAUMA



MOSQUITO-DEBAKEY

1155-8012 - 1155-8112

12,5 cm / 5"



MOSQUITO-DEBAKEY

1155-8015 - 1155-8115

15,0 cm / 6"

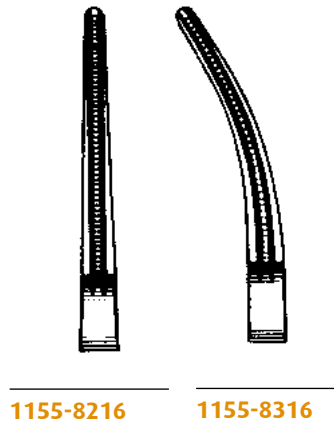

DE-BAKEY-RANKIN

1155-8216 - 1155-8316

16,0 cm / 6 1/4"

ATRAUMA

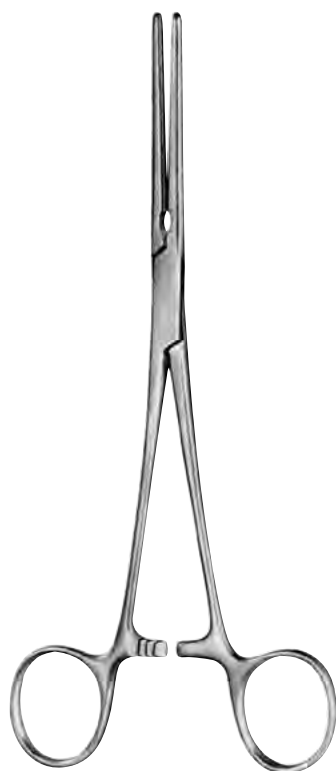

PEAN-DEBAKEY

1155-8014 - 1155-8020



1155-8014

14,5 cm / 5³/₄"



1155-8016

16,5 cm / 6¹/₂"



1155-8018

18,5 cm / 7¹/₄"

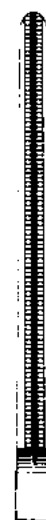

1155-8020

20,5 cm / 8"

ATRAUMA



PEAN-DEBAKEY

1155-8114 - 1155-8120



1155-8114
14,5 cm / 5³/₄"



1155-8116
16,5 cm / 6¹/₂"



1155-8118
18,5 cm / 7¹/₄"



1155-8120
20,5 cm / 8"

ATRAUMA



1155-9615
 15,0 cm / 6"



1155-9618
 18,5 cm / 7 1/4"

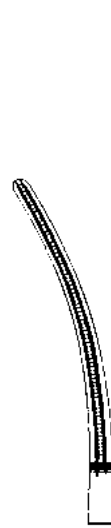
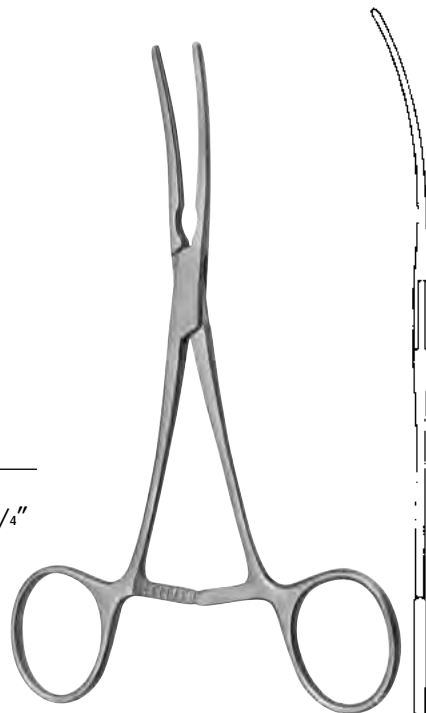

1155-9715
 15,0 cm / 6"



1155-9718
 18,5 cm / 7 1/4"

BAINBRIDGE

1155-9615 - 1155-9618

BAINBRIDGE

1155-9715 - 1155-9718



1156-1221
 21,0 cm / 8 1/4"



1156-1222
 22,5 cm / 8 3/4"

POTTS

1156-1221 - 1156-1222

ATRAUMA



1156-1321
21,0 cm / 8¹/₄"

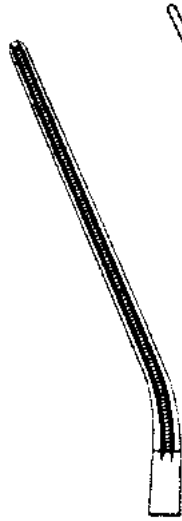

1156-1322
22,0 cm / 8³/₄"



POTTS

1156-1321 - 1156-1322

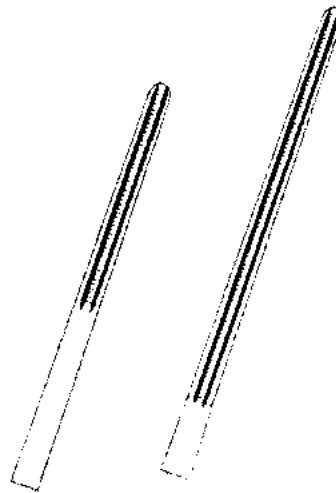

1156-1521
21,0 cm / 8¹/₄"

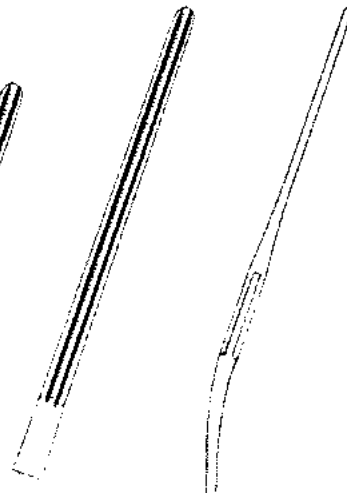

1156-1522
22,0 cm / 8³/₄"



POTTS

1156-1521 - 1156-1522

ATRAUMA



POTTS-GLOVER
 1156-0122 21,5 cm / 8 1/2"

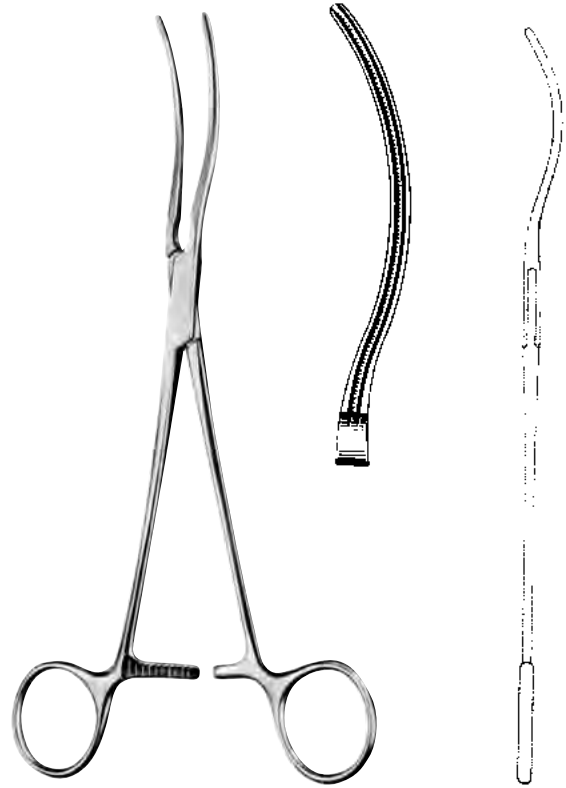

POTTS
 1156-0322 22,0 cm / 2 3/4"

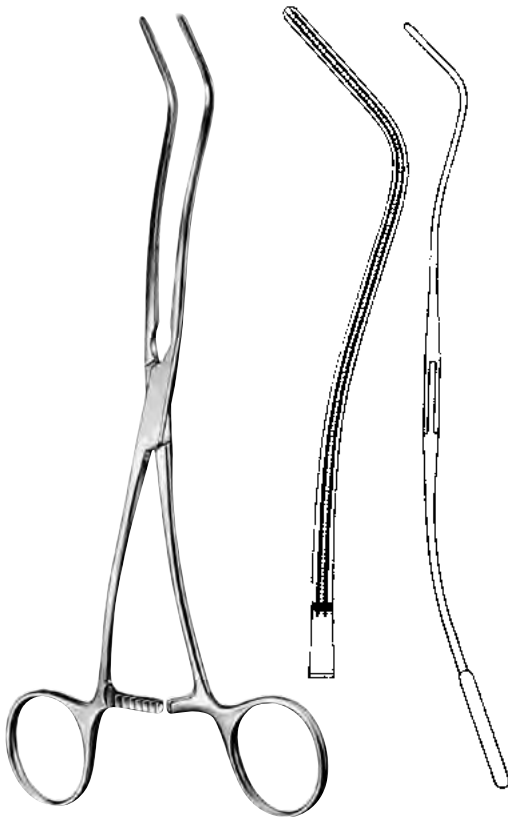

DEBAKEY
 1155-9920 20,0 cm / 8"



1156-0519
 19,0 cm / 7 1/2"

1156-0523
 24,0 cm / 9 1/2"

DEBAKEY
 1156-0519 - 1156-0523

ATRAUMA



DEBAKEY

1156-0716

16,0 cm / 6¹/₄"

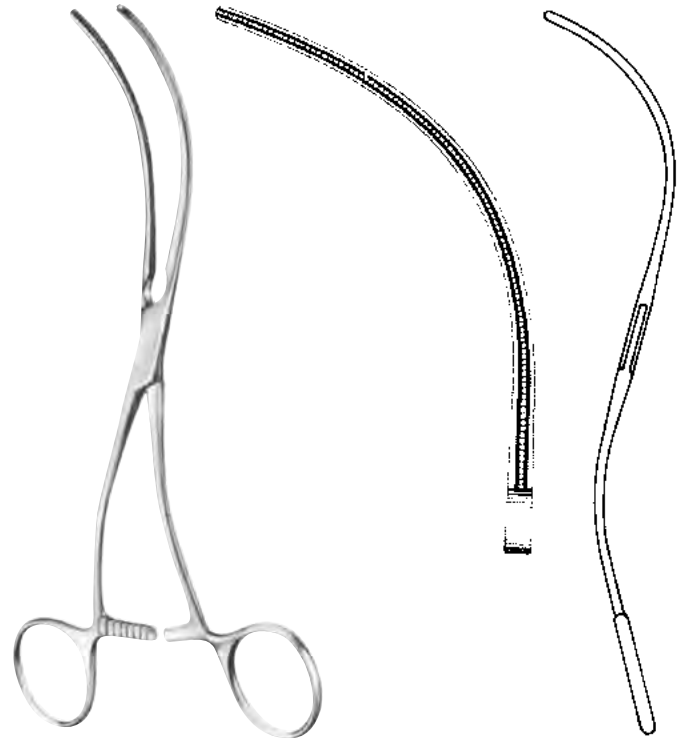

DEBAKEY

1156-0919

19,0 cm / 7¹/₂"

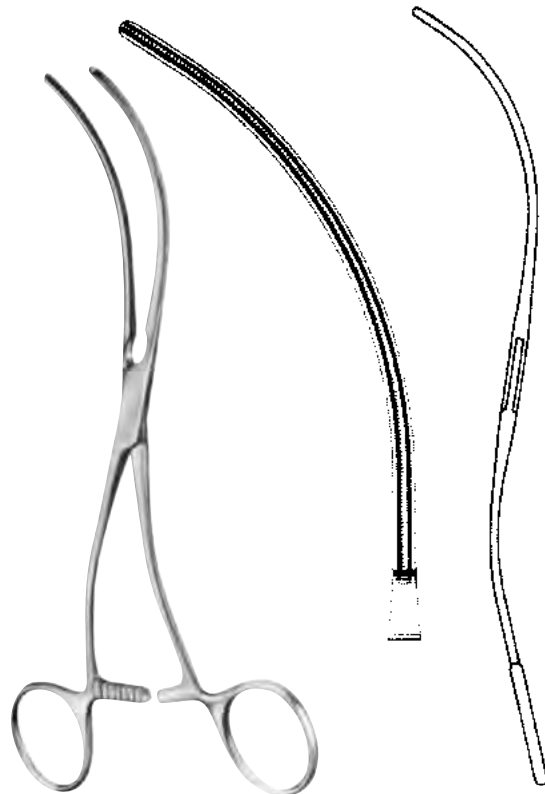

DEBAKEY

1156-0920

20,0 cm / 8"

ATRAUMA

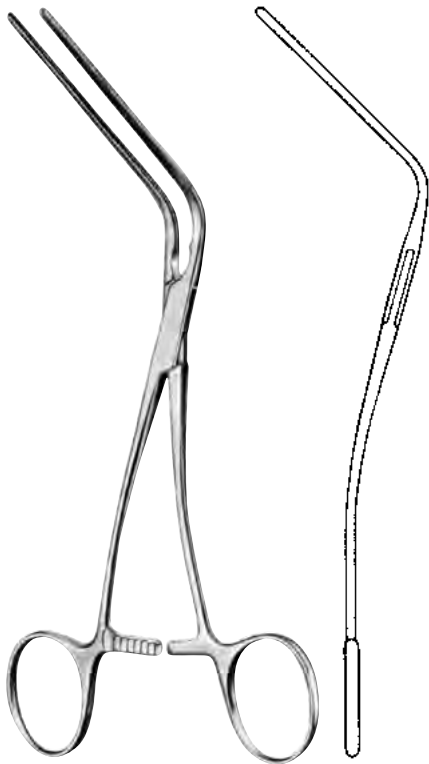

LELAND-JONES

1156-1118 18,0 cm / 7"

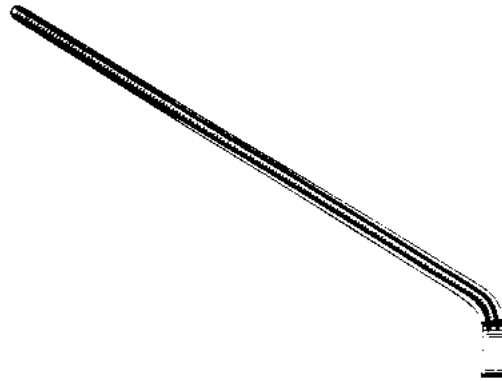

LELAND-JONES

1156-1120 20,0 cm / 8"

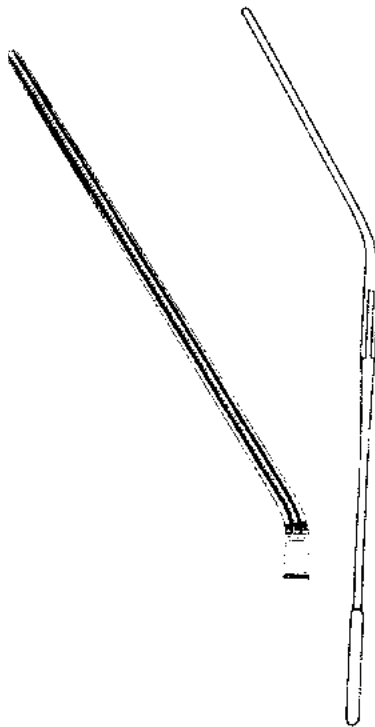

LELAND-JONES

1156-1119 19,0 cm / 7½"

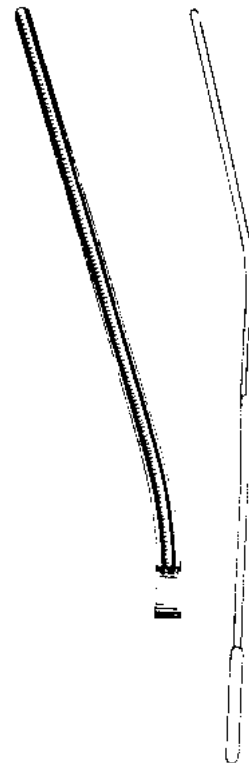

ATRAUMA

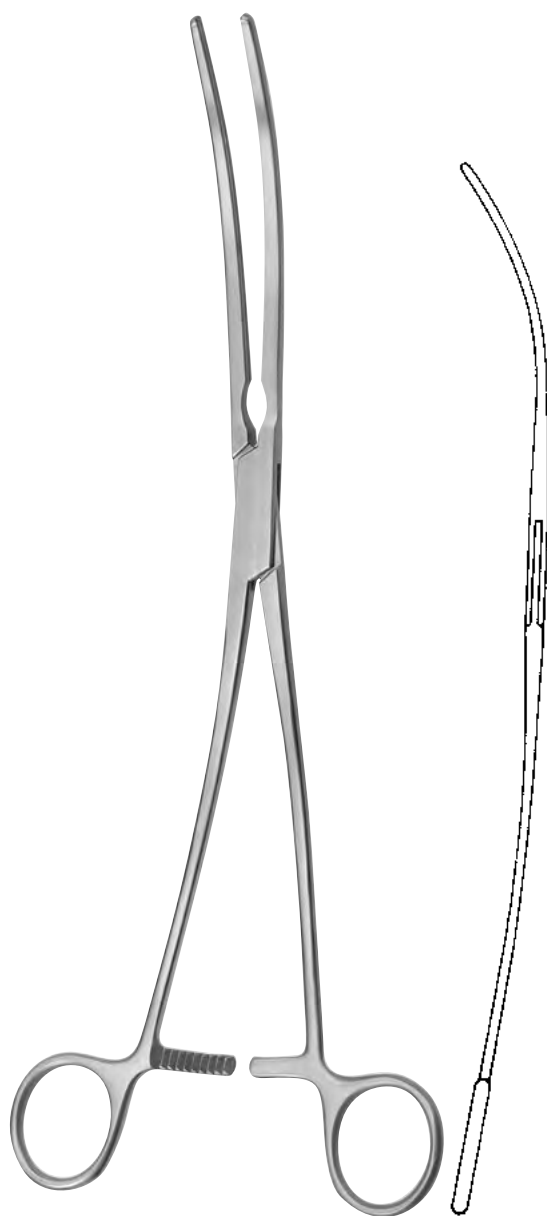

1155-8725
26,0 cm / 10¹/₄"

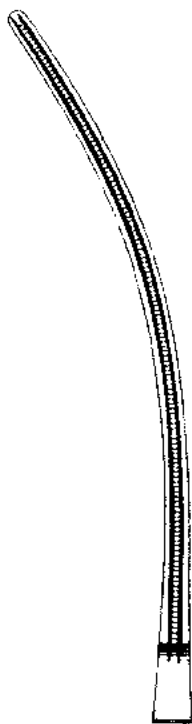

1155-8727
27,0 cm / 10³/₄"

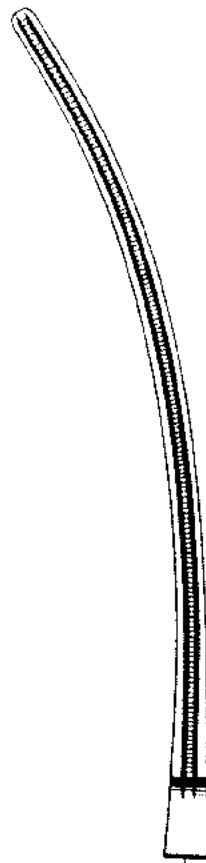

1155-8730
31,0 cm / 12¹/₄"

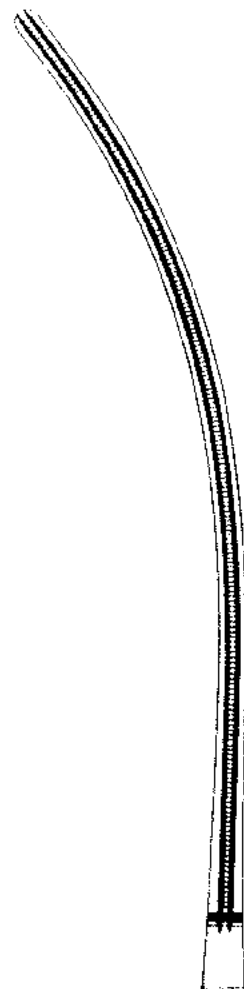

1155-8733
33,0 cm / 13,0"

DEBAKEY

1155-8725 - 1155-8733

ATRAUMA

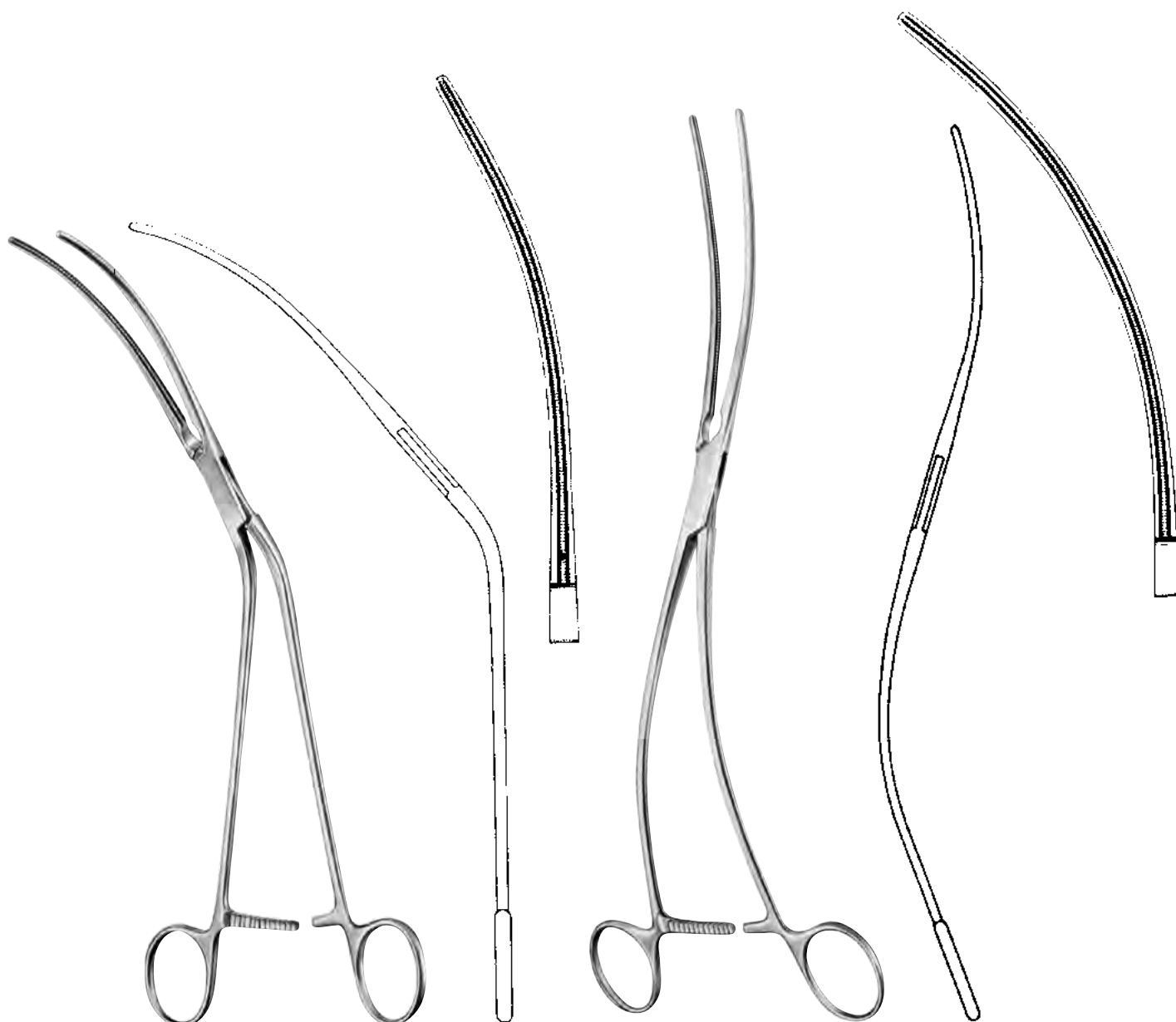

DEBAKEY

1155-9528

28,0 cm / 11"

DEBAKEY

1155-9530

30,0 cm / 11³/₄"

ATRAUMA

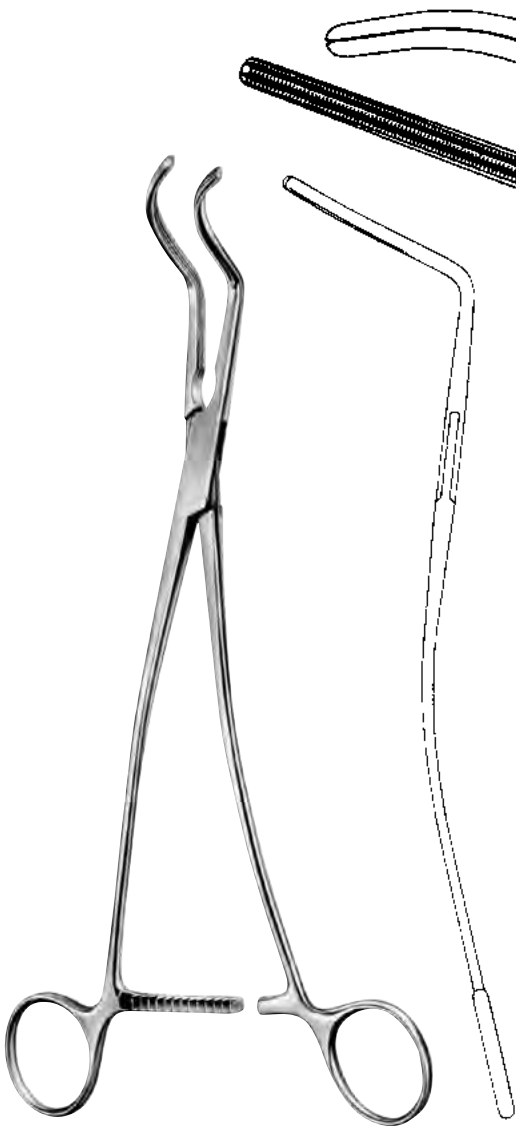

DEBAKEY

1156-2727

27,0 cm / 10³/₄"

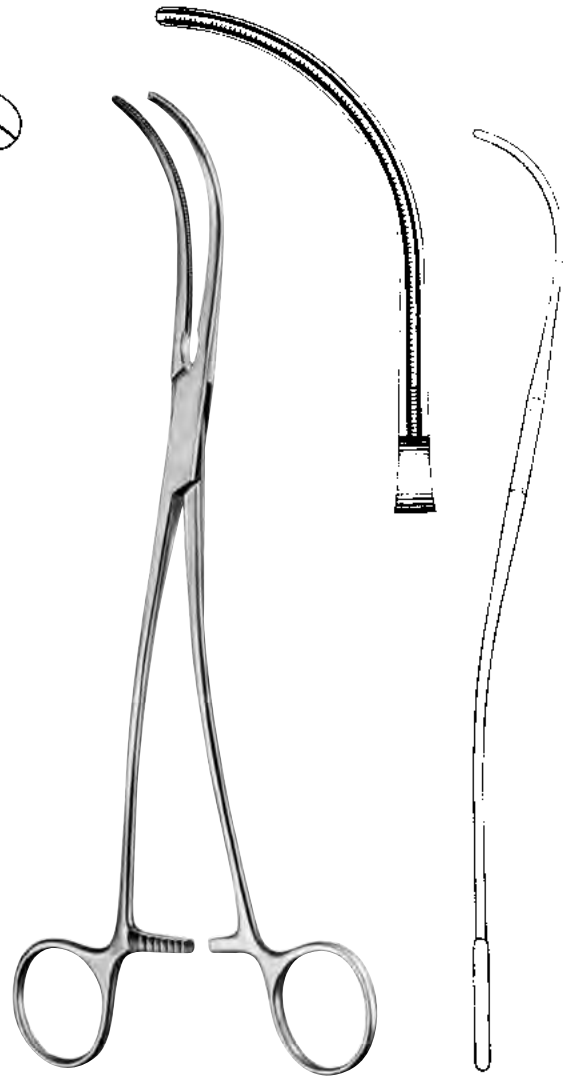

DEBAKEY

1156-3124

24,5 cm / 9³/₄"

ATRAUMA

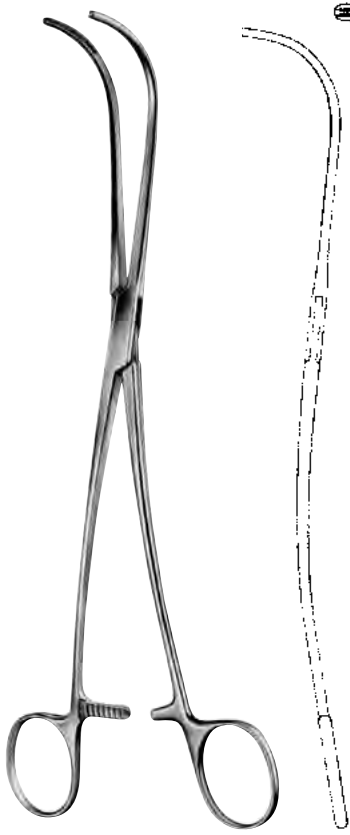

DEBAKEY

1156-2924

24,5 cm / 9³/₄"

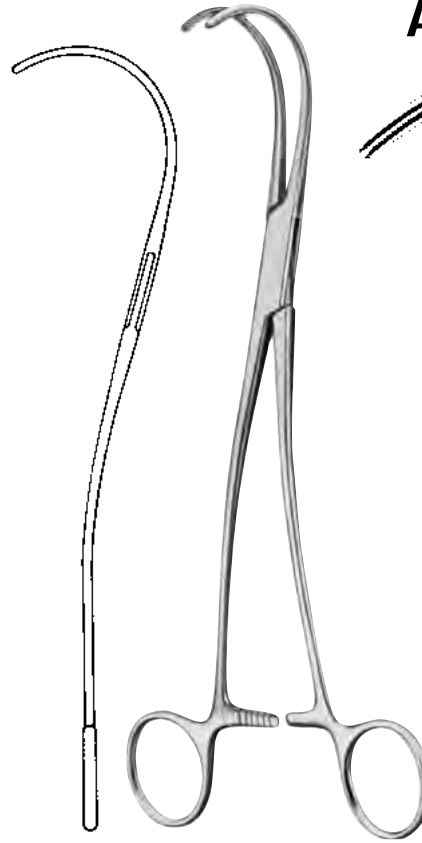

DEBAKEY

1155-9125

27,0 cm / 10¹/₂"

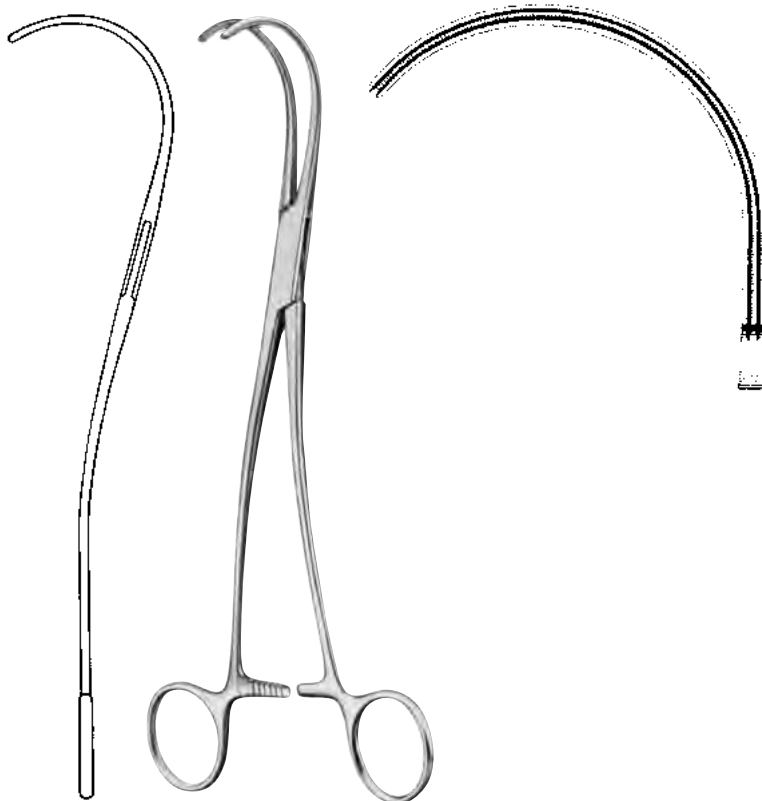

DEBAKEY

1155-9126

27,0 cm / 10¹/₂"

ATRAUMA

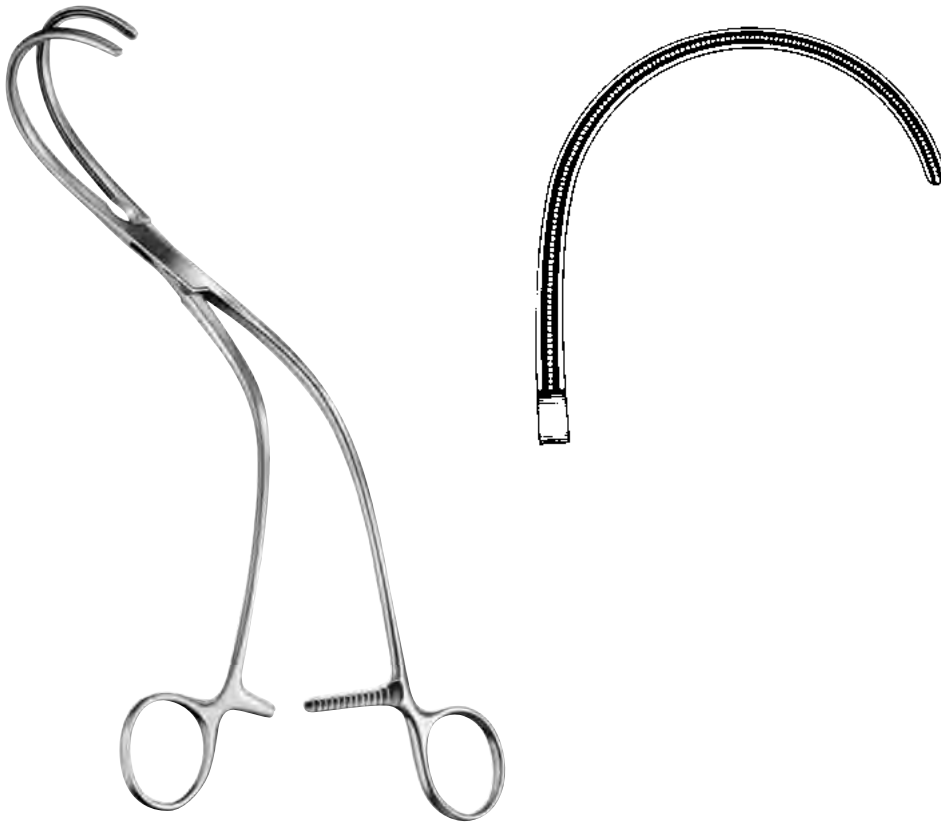

WEBER

1155-3901

24,0 cm / 9¹/₂ "



WEBER

1155-3902

24,0 cm / 9¹/₂ "

ATRAUMA



1156-4720 22,0 cm / 8³/₄"



1156-4724 26,0 cm / 10¹/₄"

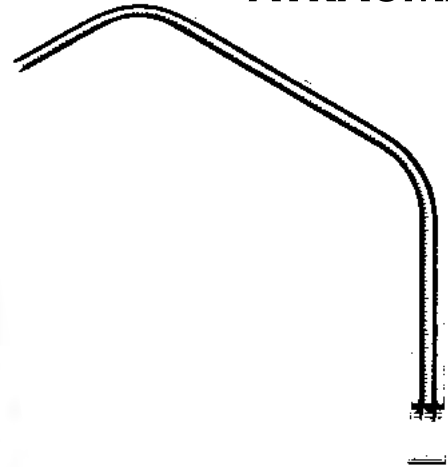

1156-4725 26,5 cm / 10¹/₂"

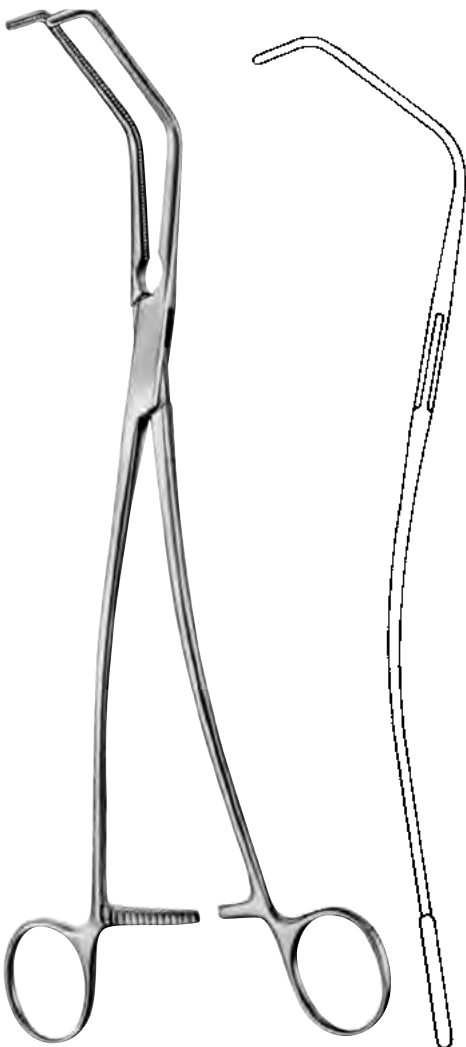

SATINSKY

1156-4720 - 1156-4727

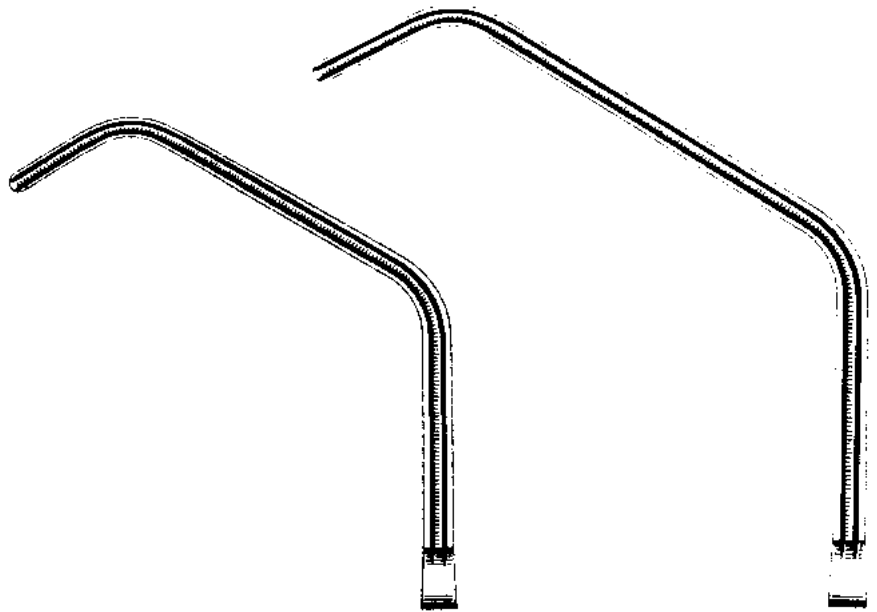

1156-4726 27,5 cm / 10³/₄"

1156-4727 28,5 cm / 11¹/₄"

ATRAUMA

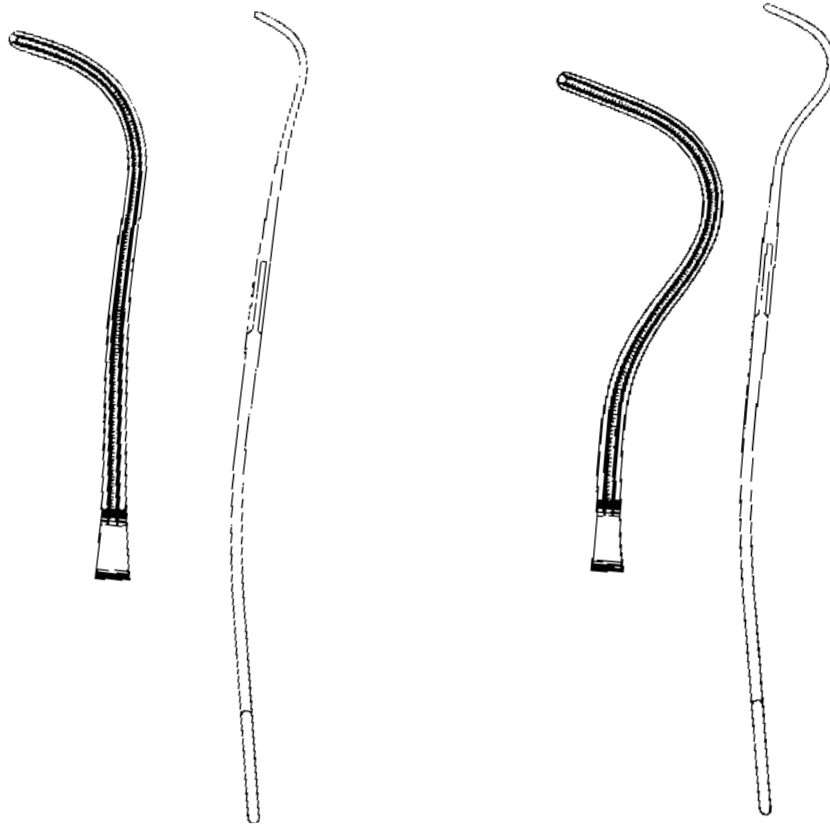

1156-5301 24,5 cm / 9³/₄"

1156-5302 24,0 cm / 9¹/₂"



HARKEN

1156-5301 - 1156-5302

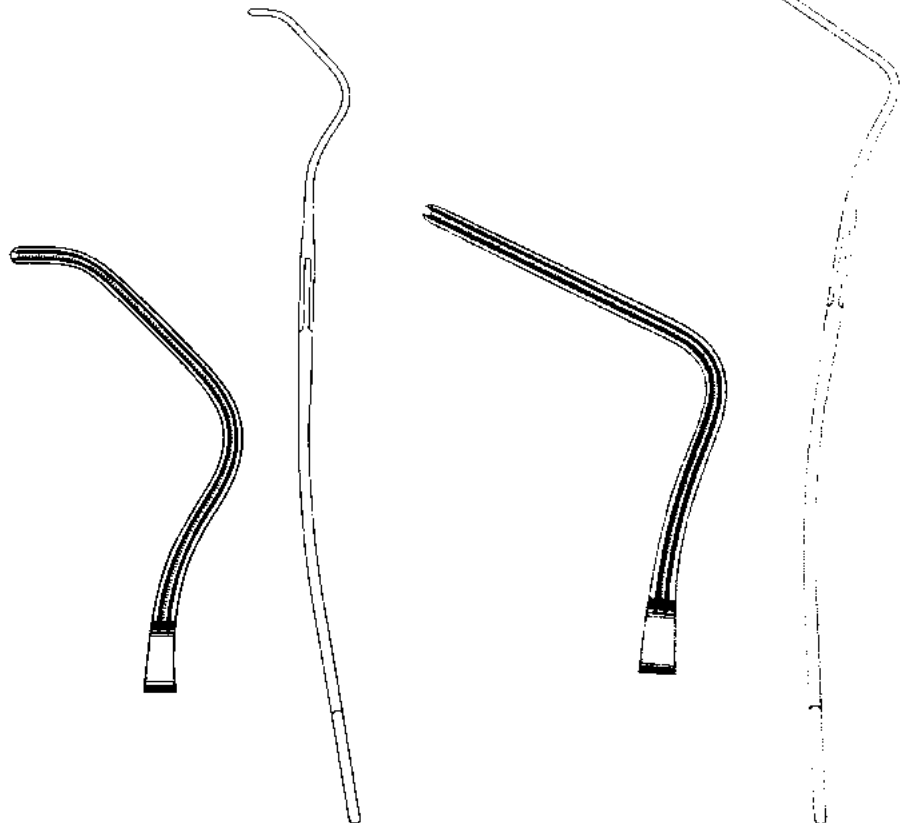

1156-5303 23,0 cm / 9"

1156-5304
23,5 cm / 9¹/₄"

ATRAUMA



LEES

1156-2123 - 1156-2125

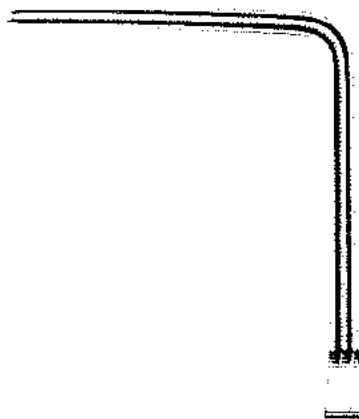

1156-2123 23,0 cm / 9"

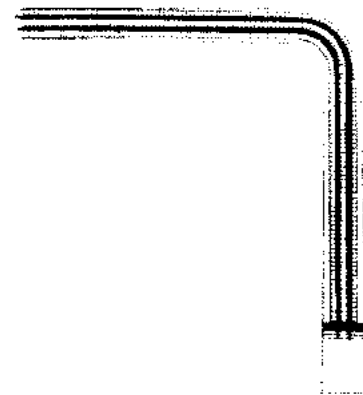

1156-2125 25,5 cm / 10"



LEES

1156-2325 25,0 cm / 9³/₄"

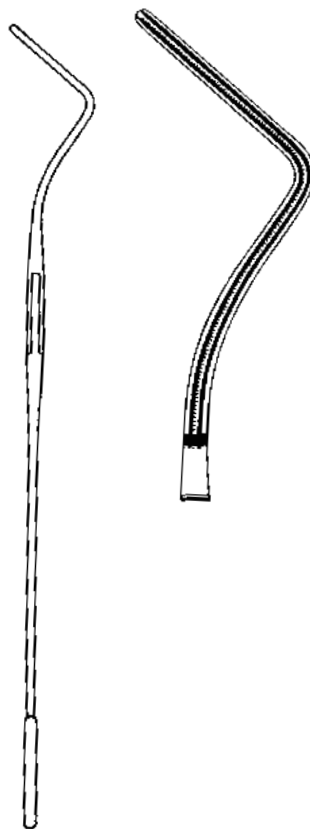

ATRAUMA



LAMBERT-KAY

1156-4321 - 1156-4322

22,5 cm / 8³/₄"

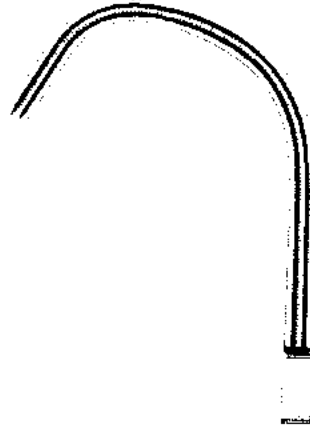

1156-4321

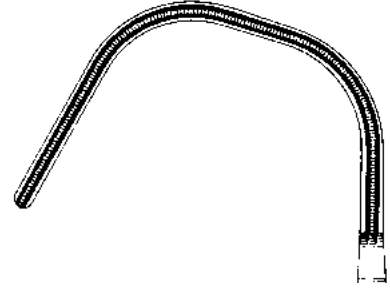

1156-4322



DEBAKEY

1156-4517

17,0 cm / 6³/₄"

ATRAUMA

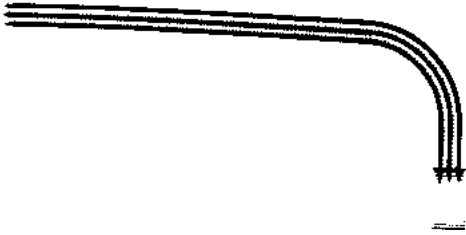

1156-2501 18,0 cm / 7"

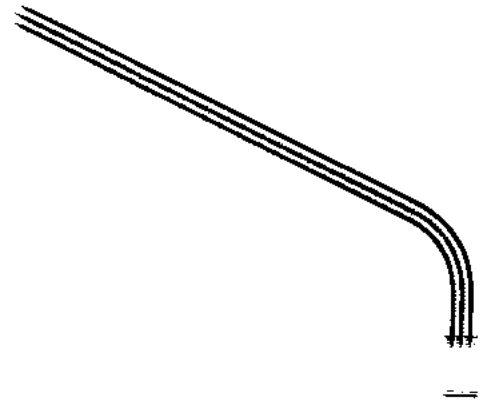

1156-2502 20,0 cm / 8"

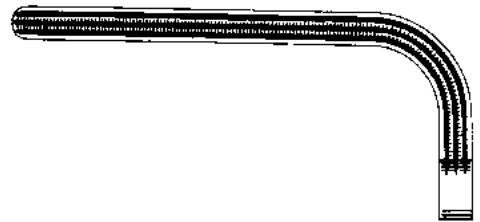

1156-2503 24,0 cm / 9 1/2"

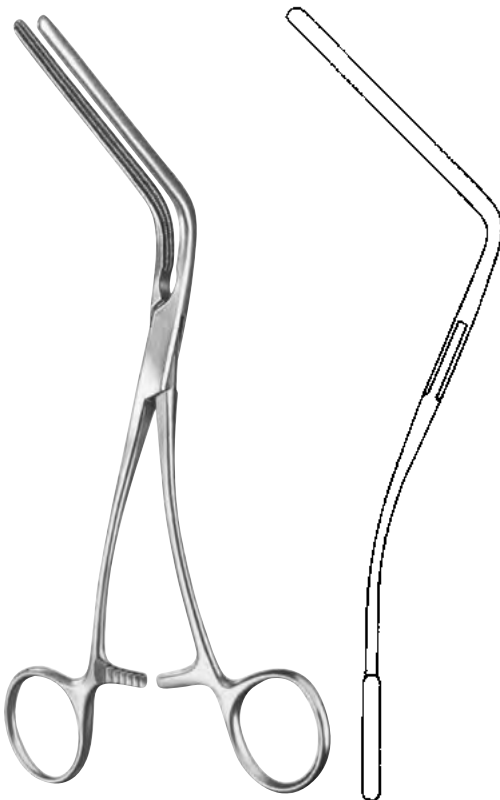

MORRIS-DEBAKEY

1156-2501 - 1156-2504

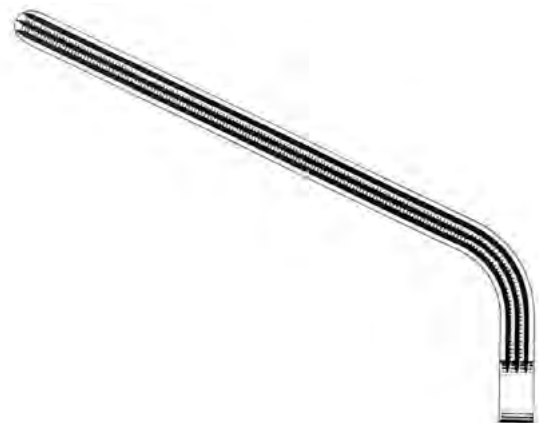

1156-2504 26,0 cm / 10 1/4"

ATRAUMA

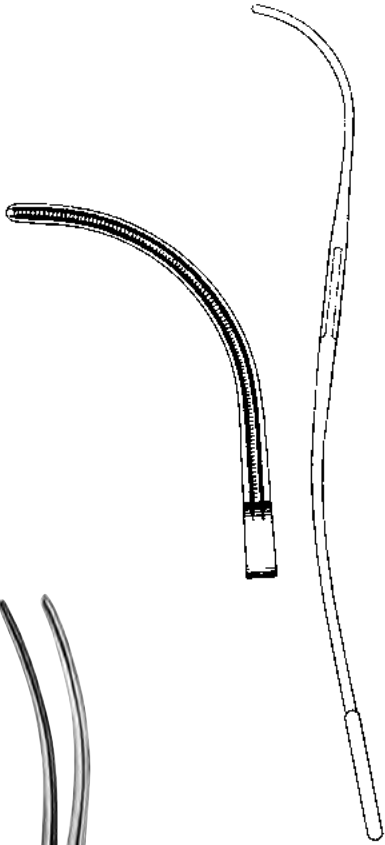

1155-8923 23,5 cm / 9¹/₄"

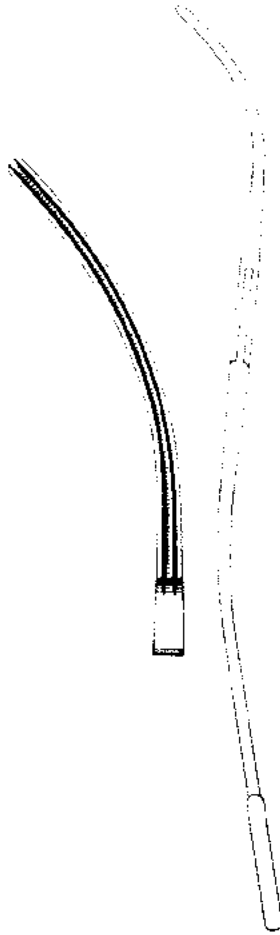

1155-8924 24,5 cm / 9¹/₂"

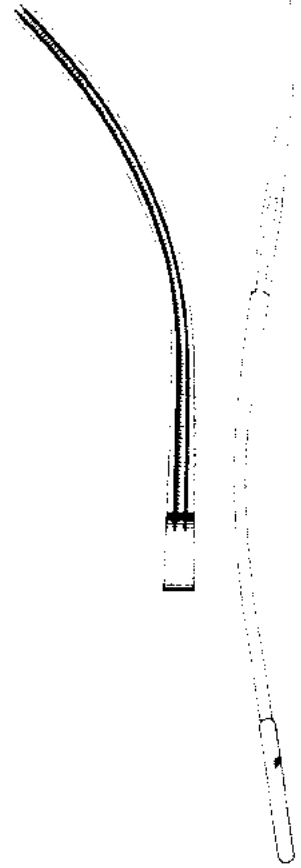

1155-8925 25,5 cm / 10"



BAHNSON-DEBAKEY

1155-8923 - 1155-8925

ATRAUMA



POTTS

1155-8421 - 1155-8431



1155-8421

21,5 cm / 8¹/₂"



1155-8423

23,5 cm / 9¹/₄"



1155-8427

27,0 cm / 10³/₄"



1155-8431

31,0 cm / 12¹/₄"



POTTS

1155-8521 - 1155-8531



1155-8521

21,0 cm / 8¹/₄"



1155-8523

23,0 cm / 9"



1155-8527

26,0 cm / 10¹/₄"



1155-8531

30,5 cm / 12"

ATRAUMA

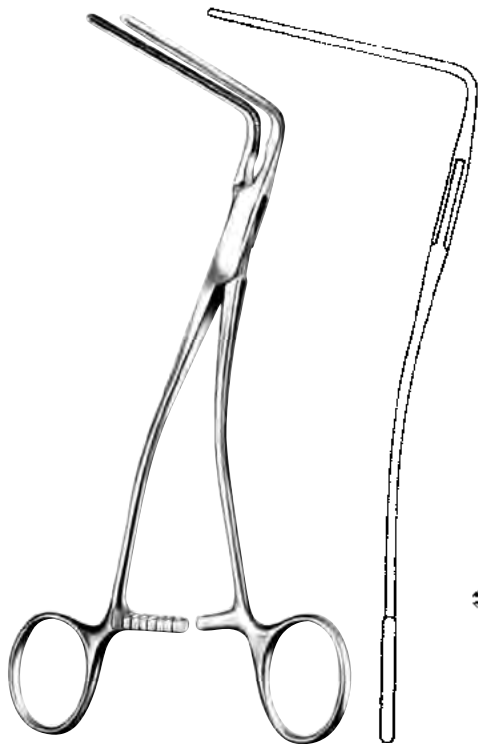

DEBAKEY
 1156-1718 - 1156-1726

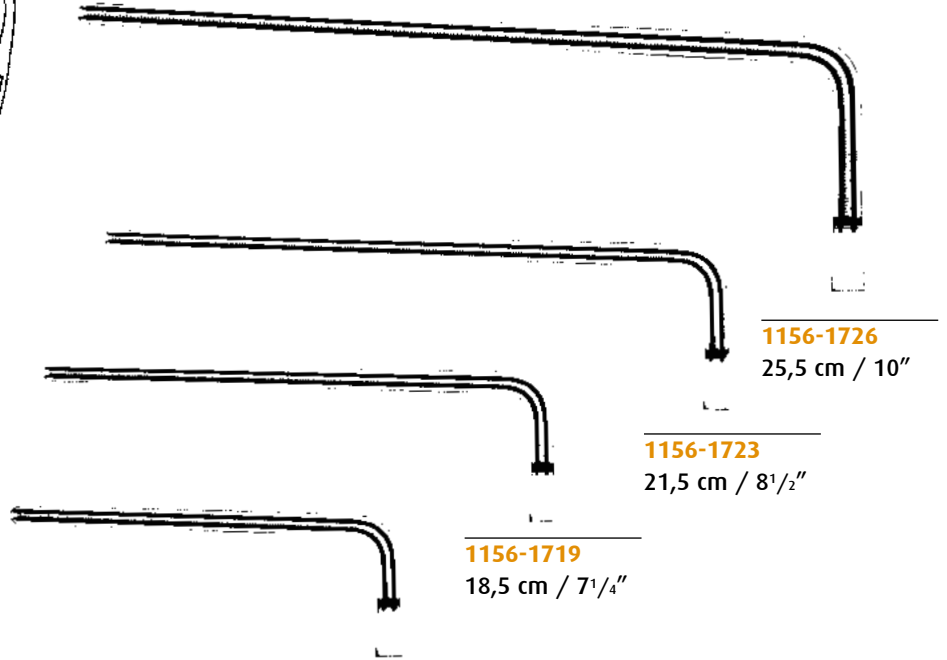

1156-1726
 25,5 cm / 10"

1156-1723
 21,5 cm / 8 1/2"

1156-1719
 18,5 cm / 7 1/4"

1156-1718
 18,0 cm / 7"

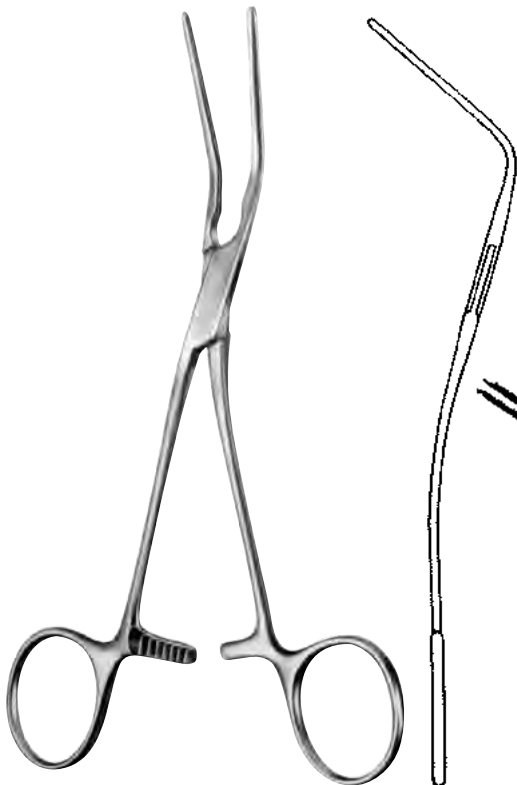

DEBAKEY
 1156-1920 - 1156-1929

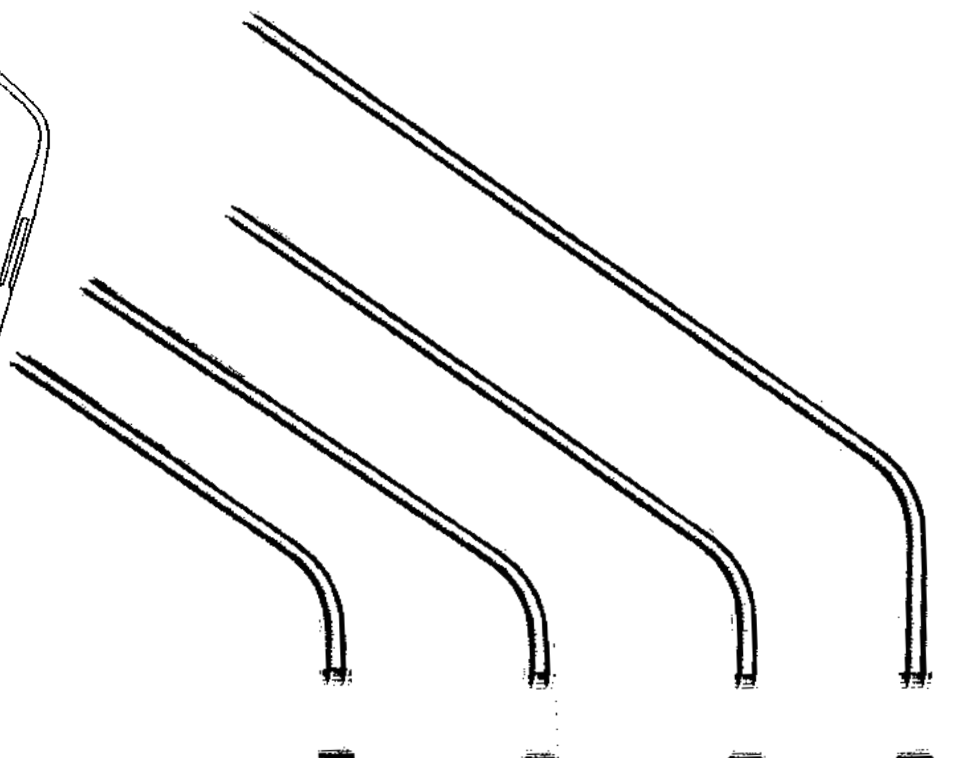

1156-1920
 21,0 cm / 8 1/4"

1156-1921
 22,0 cm / 8 3/4"

1156-1925
 26,0 cm / 10 1/4"

1156-1929
 31,0 cm / 12 1/4"

ATRAUMA

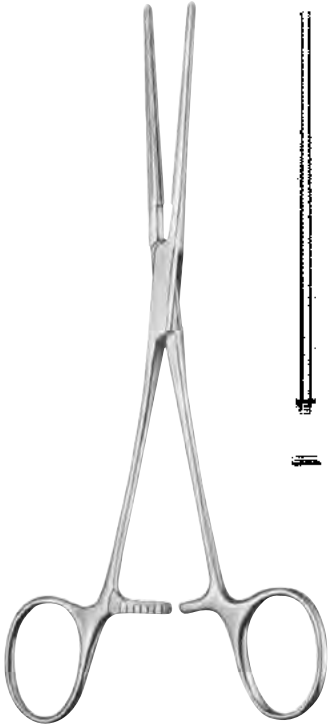

DEBAKEY

1155-6217 17,0 cm / 6³/₄"

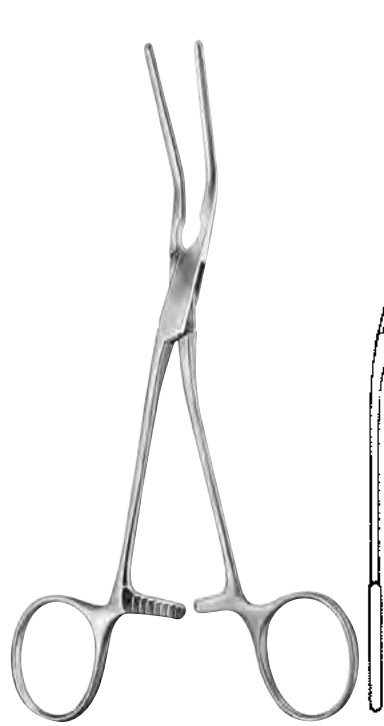

DEBAKEY

1155-6316 16,5 cm / 6¹/₂"



DEBAKEY

1155-6515 16,0 cm / 6¹/₄"



DEBAKEY

1155-6715 14,5 cm / 5³/₄"



DEBAKEY

1155-6917 16,5 cm / 6¹/₂"

ATRAUMA

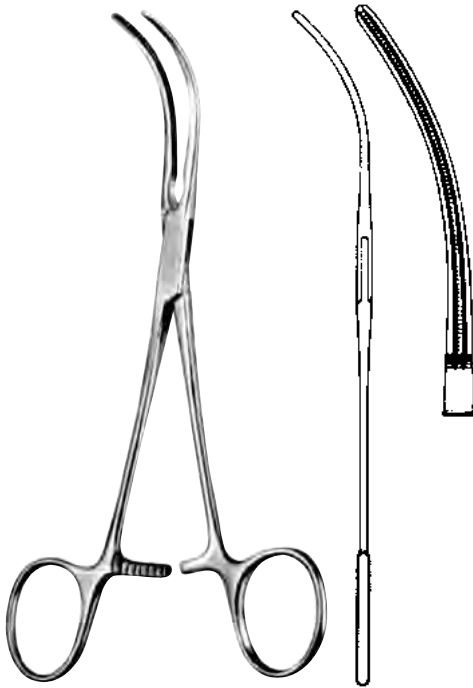

GLOVER

1155-7117

17,0 cm / 6³/₄"

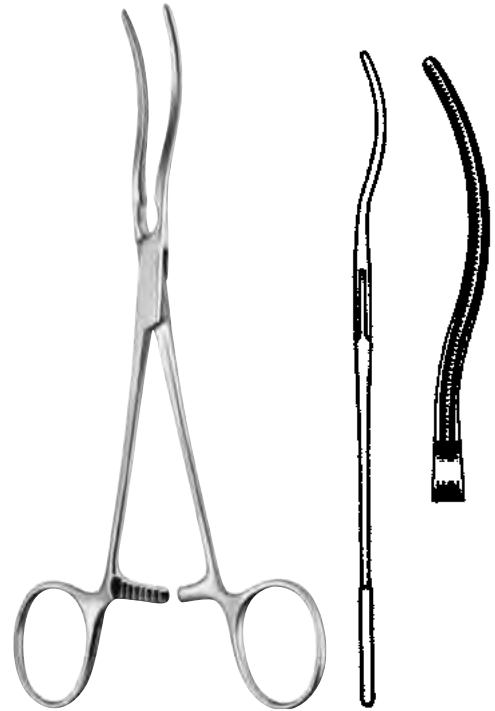

GLOVER

1155-7317

17,5 cm / 7"

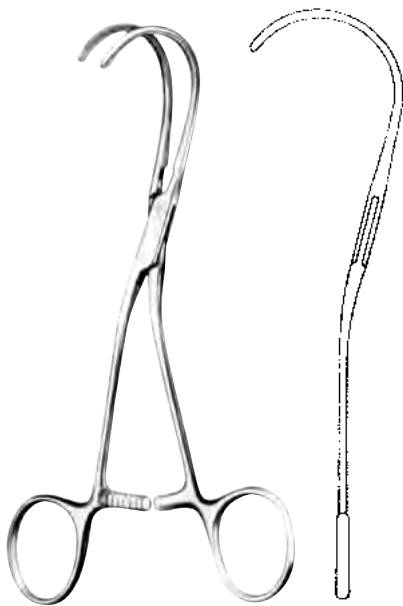

DEBAKEY

1155-7516 - 1155-7517

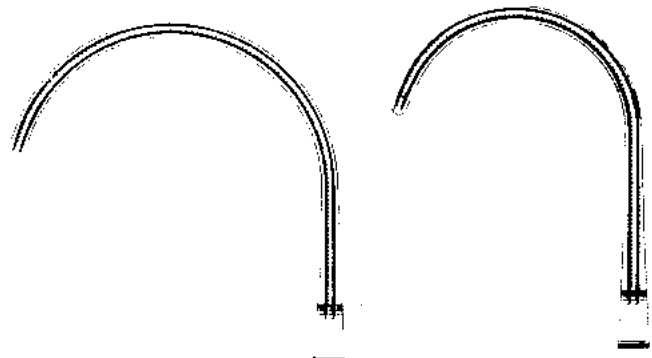

1155-7516

16,5 cm / 6¹/₂"

1155-7517

17,0 cm / 6³/₄"

ATRAUMA

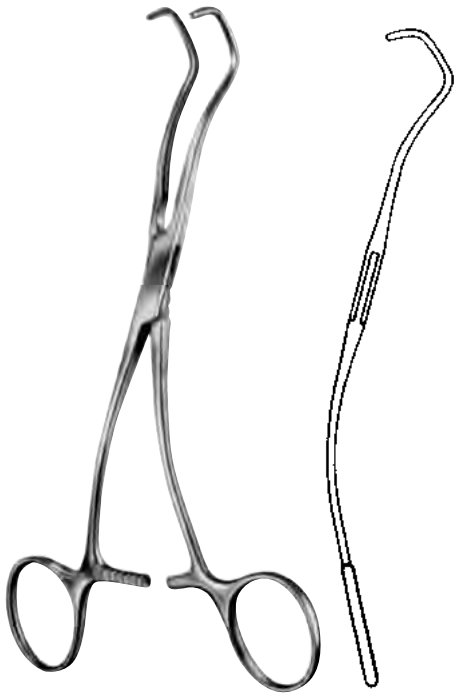

DERRA

1155-7716 - 1155-7718

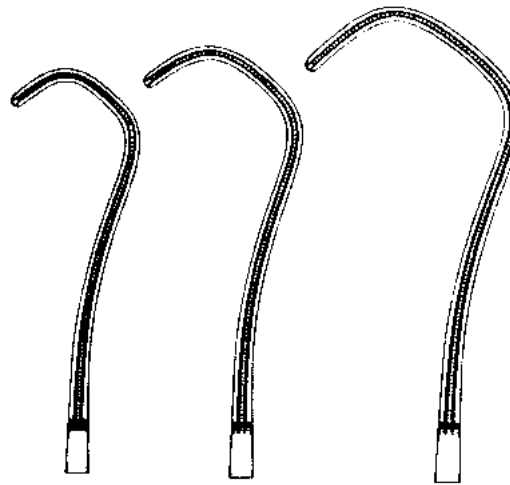

Fig. 1

1155-7716

16,5 cm / 6¹/₂"

Fig. 2

1155-7717

17,0 cm / 6³/₄"

Fig. 3

1155-7718

18,0 cm / 7"



BECK

1155-7917

17,0 cm / 6³/₄"

ATRAUMA



OCHSNER

1156-4923

23,5 cm / 9¹/₄"



DIETRICH

1156-5022

22,0 cm / 8³/₄"

ATRAUMA



GREGORY

1156-3314 - 1156-3318

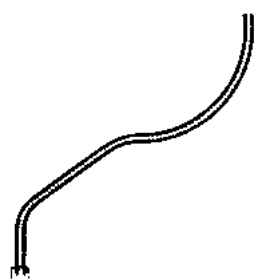

1156-3314

14,0 cm / 5¹/₂"

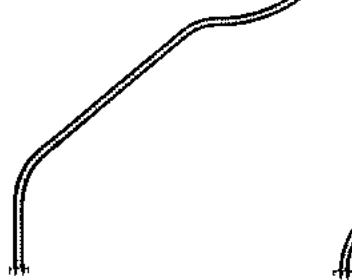

1156-3316

16,0 cm / 6¹/₄"

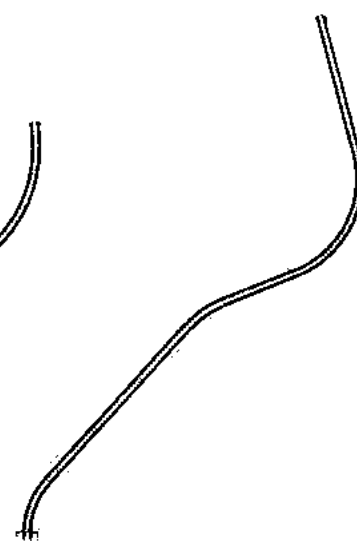

1156-3318

18,0 cm / 7"

ATRAUMA

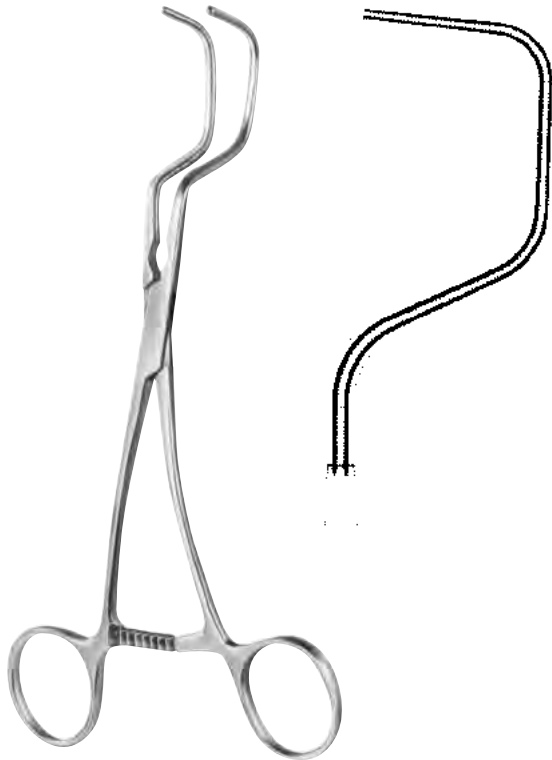

DALE

1156-3918 18,0 cm / 7"



1156-4117
17,5 cm / 6³/₄"

1156-4118
18,0 cm / 7"

1156-4119
19,0 cm / 7¹/₂"

DALE

1156-4117 - 1156-4119

ATRAUMA

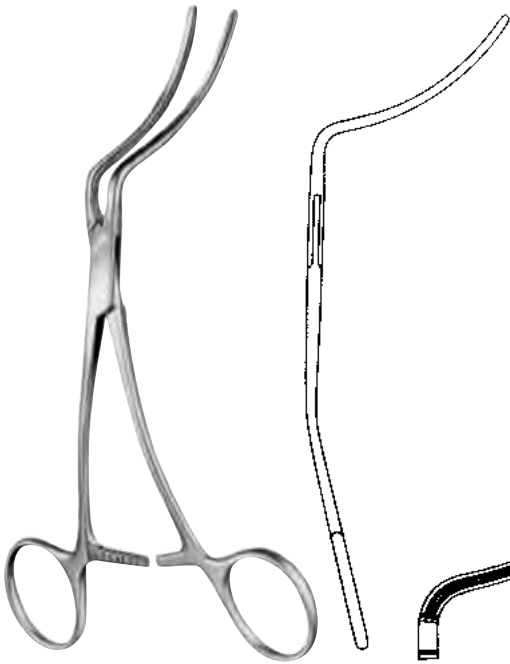

MARTIN

1156-3811

16,0 cm / 6¹/₄"

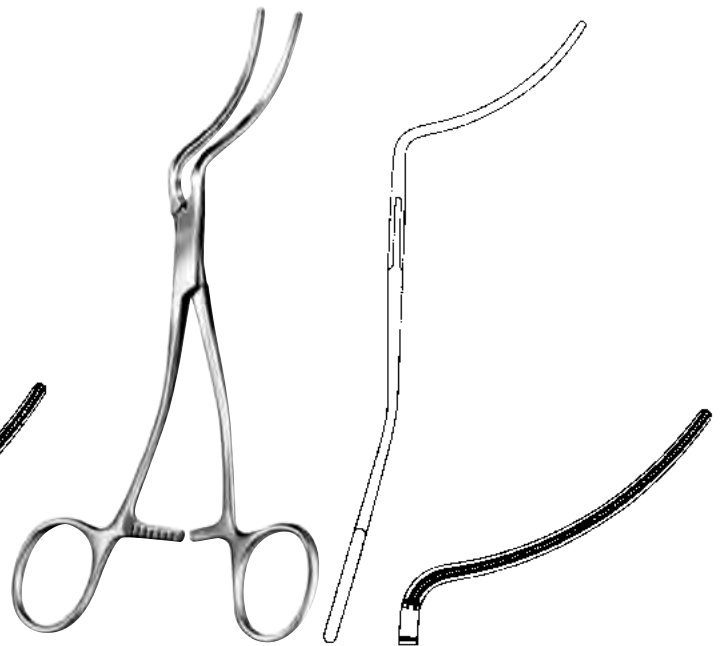

MARTIN

1156-3812

16,5 cm / 6¹/₂"

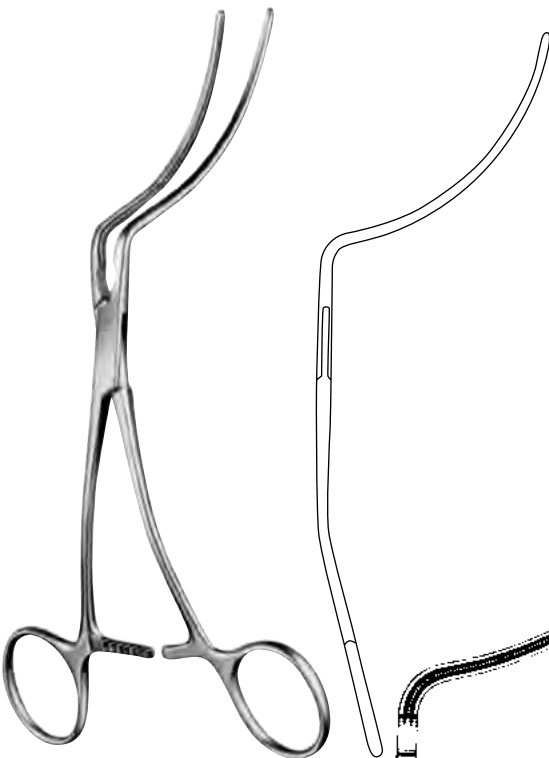

MARTIN

1156-3813

18,0 cm / 7"

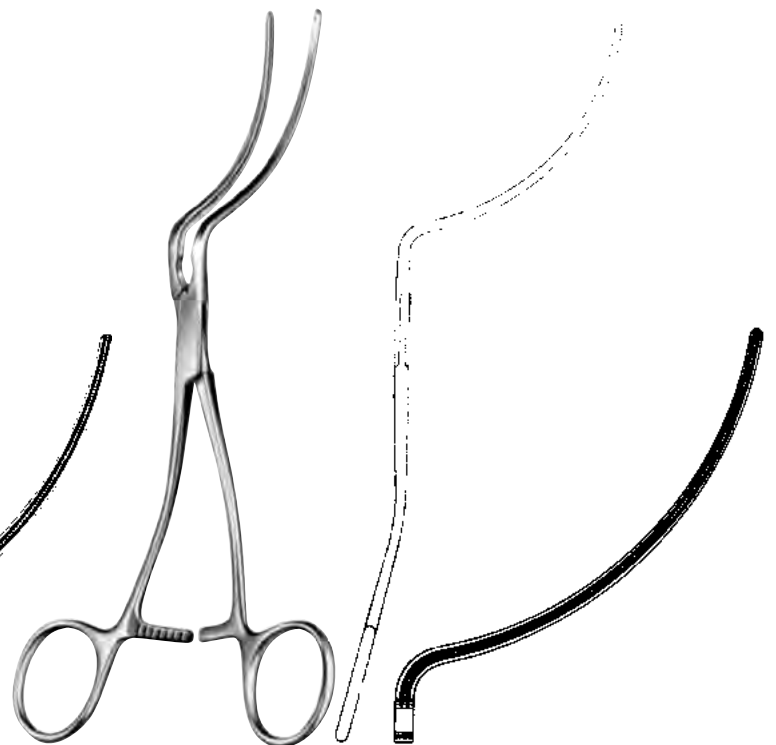

MARTIN

1156-3824

19,5 cm / 7³/₄"

ATRAUMA

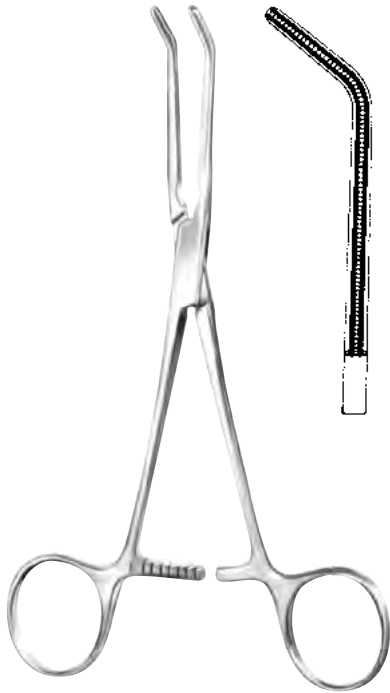

HUSFELDT
1156-3601

17,5 cm / 7"



HUSFELDT
1156-3602

18,0 cm / 7"



HUSFELDT
1156-3603

17,0 cm / 6³/₄"

ATRAUMA

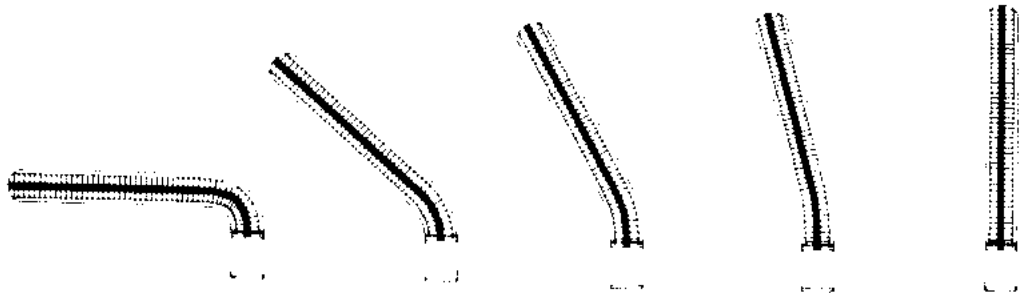

1156-8000

15,0 cm / 5 1/2"
90°

1156-8045

15,0 cm / 5 1/2"
45°

1156-6830

15,0 cm / 5 1/2"
30°

1156-8015

15,0 cm / 5 1/2"
15°

1156-8000

15,0 cm /
5 1/2"

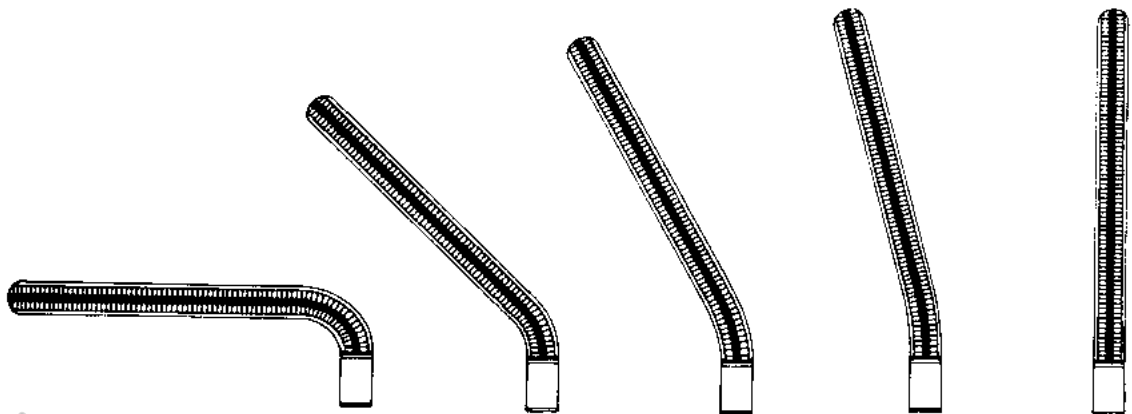

1156-8290

17,0 cm / 6 1/2"
90°

1156-8245

17,0 cm / 6 1/2"
45°

1156-8230

17,0 cm / 6 1/2"
30°

1156-8215

17,0 cm / 6 1/2"
15°

1156-8200

17,0 cm /
6 1/2"



DARDIK

1156-8000 - 1156-8000

15,0 cm / 5 1/2"

1156-8290 - 1156-8200

17,0 cm / 6 1/2"

ATRAUMA

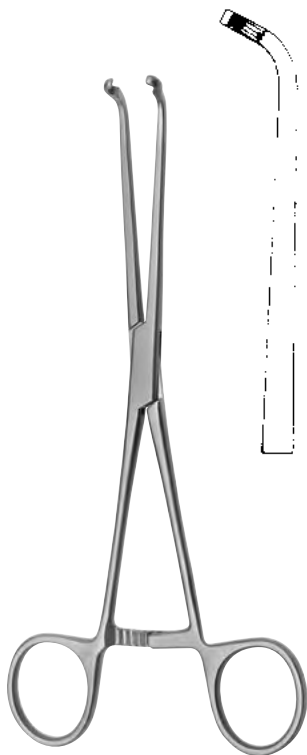

JAVID
1156-3516 17,5 cm / 7"

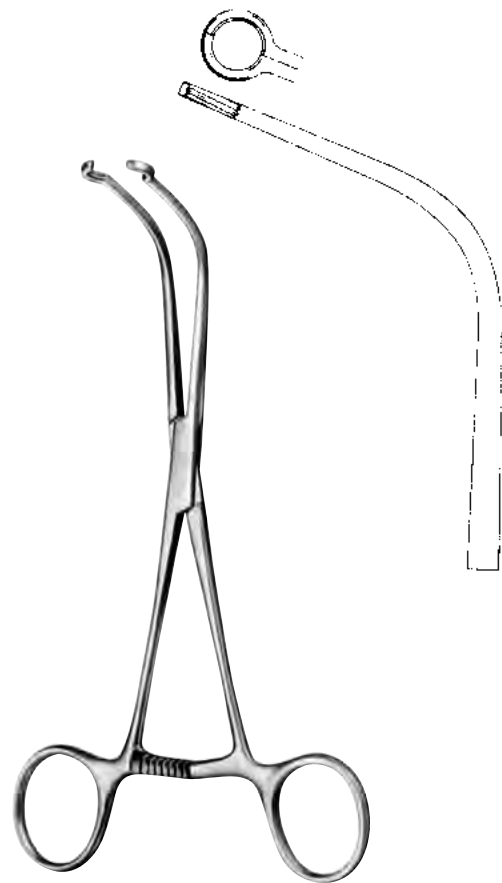

JAVID
1156-3519 19,0 cm / 7½"

ATRAUMA



SUBRAMANIAN-MINIATURE

1155-4515 15,5 cm / 6"

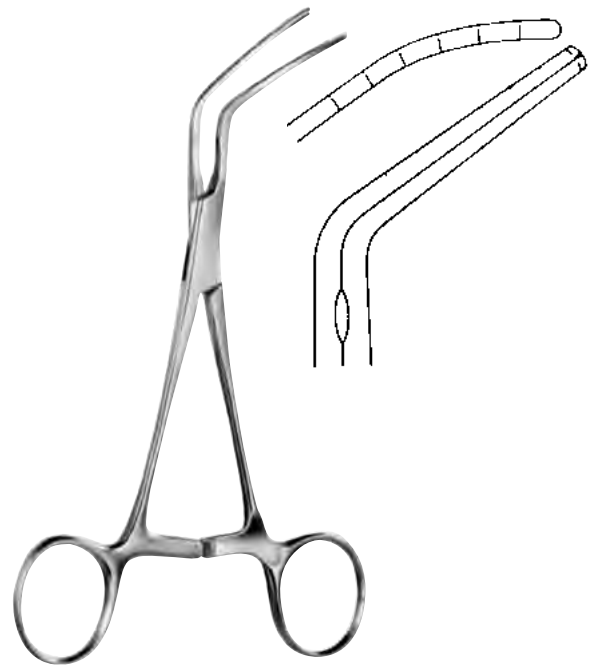

SUBRAMANIAN

1155-7416 16,0 cm / 6 1/4"

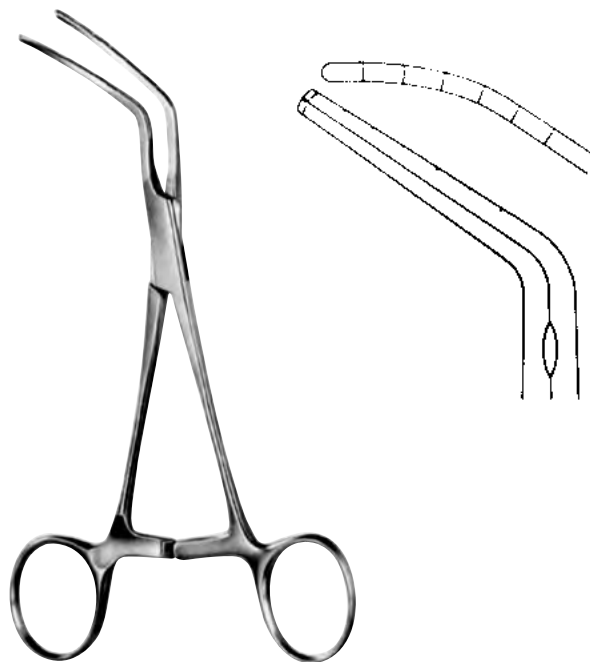

SUBRAMANIAN

1155-4916 16,0 cm / 6 1/4"

ATRAUMA

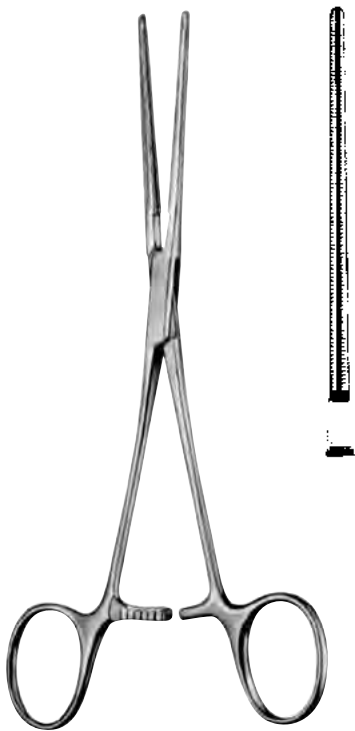

COOLEY

1156-7217 17,0 cm / 6³/₄"

Iliacklemme
Iliac Clamp
Pinza para iliaca
Pinza iliaca



COOLEY

1156-7311 22,0 cm / 8³/₄"

Carotisklemmen
Carotid Clamps
Pinza para carótida
Pinza per carotis

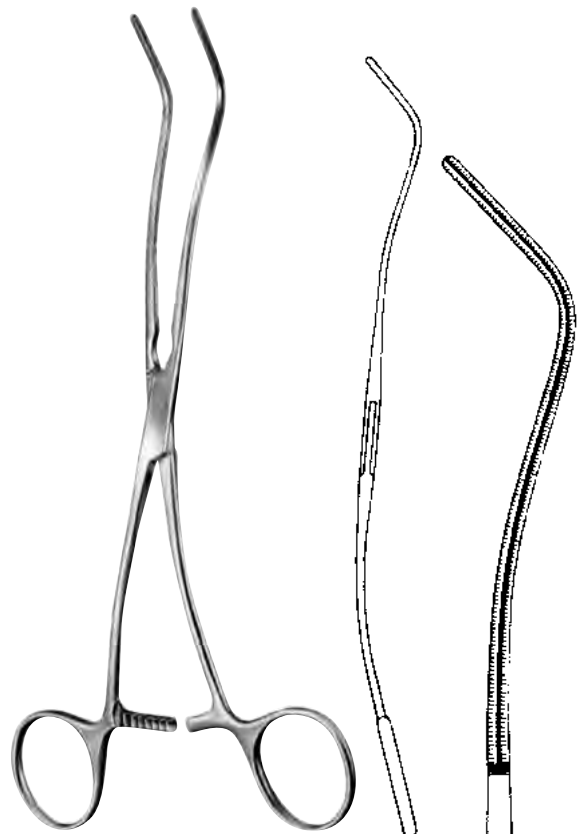

COOLEY

1156-7520 20,0 cm / 8"

ATRAUMA

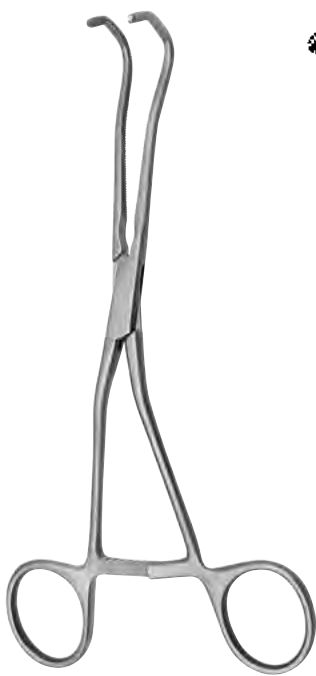

COOLEY

1156-6717

17,0 cm / 6³/₄"

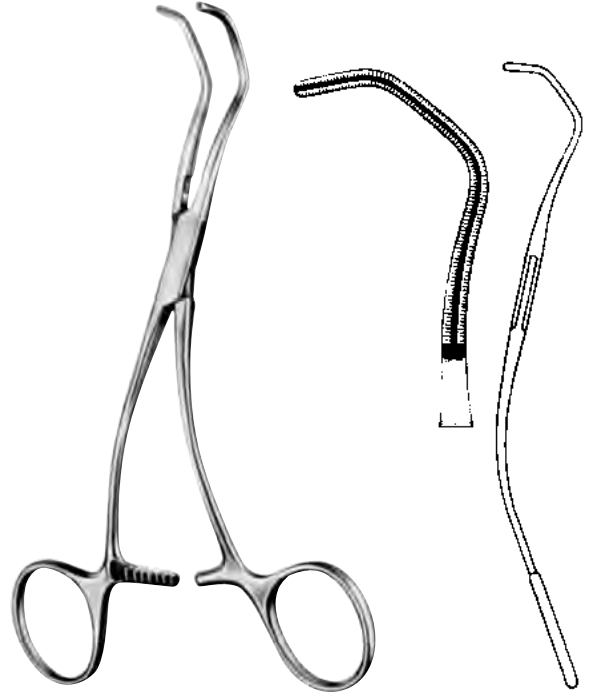

COOLEY

1156-6916

16,0 cm / 6¹/₄"



COOLEY

1156-7115

14,0 cm / 5¹/₂"

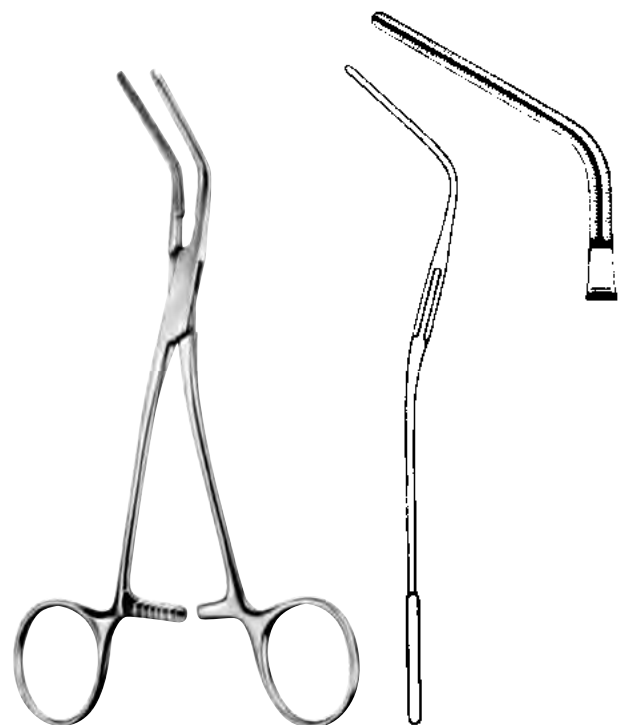

COOLEY

1156-6002

16,0 cm / 6¹/₄"

ATRAUMA



COOLEY
1156-7117 17,0 cm / 6³/₄"

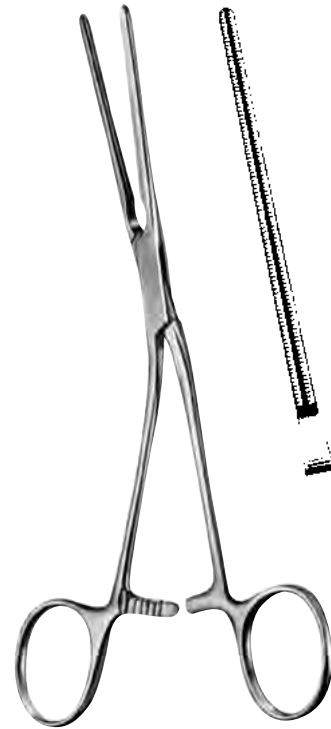

COOLEY
1156-6101 17,0 cm / 6³/₄"

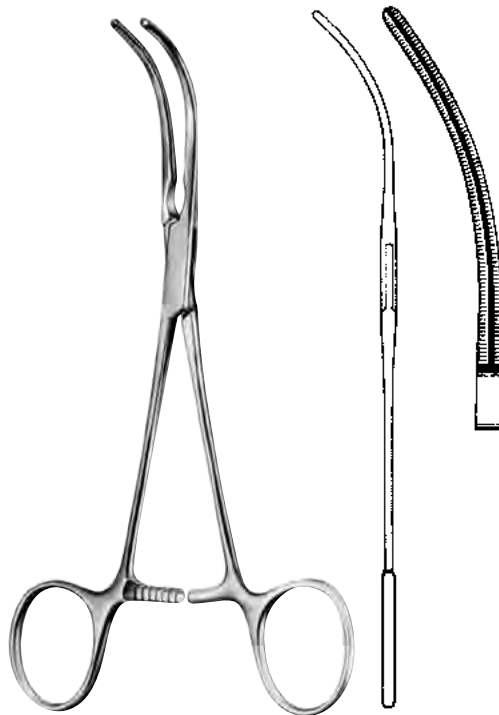

COOLEY
1156-6102 17,0 cm / 6³/₄"

ATRAUMA



COOLEY

1156-6103

17,5 cm / 7"

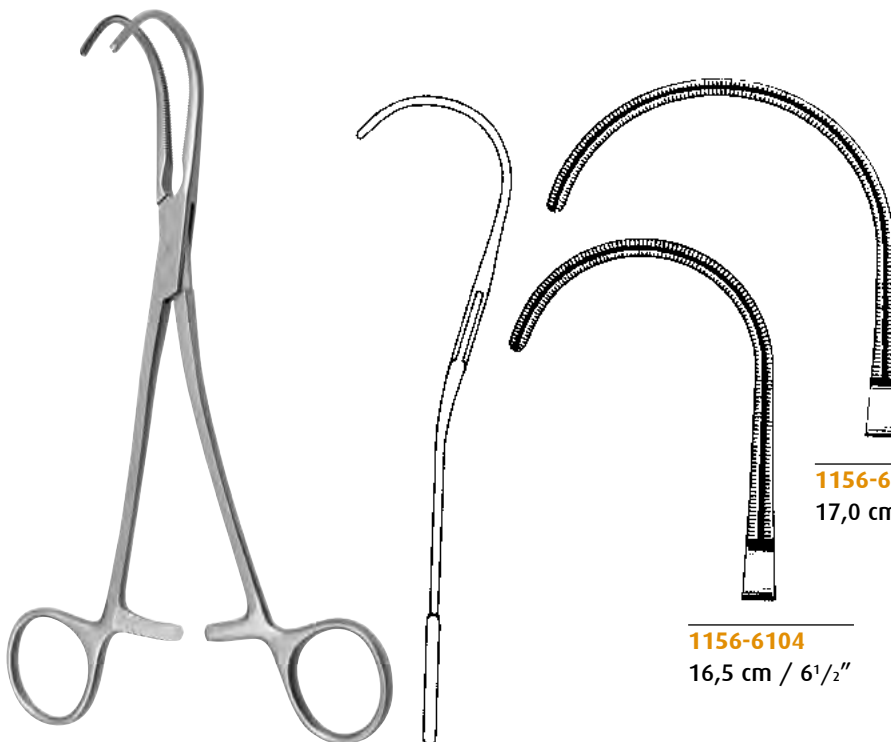

1156-6105

17,0 cm / 6³/₄"

1156-6104

16,5 cm / 6¹/₂"

COOLEY

1156-6104 - 1156-6105

ATRAUMA



1156-3401
16,0 cm / 6¹/₄"
24 Charr.



1156-3402
16,0 cm / 6¹/₄"
26 Charr.

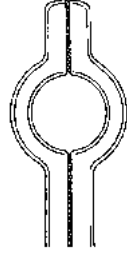

1156-3403
20,0 cm / 8"
28 Charr.

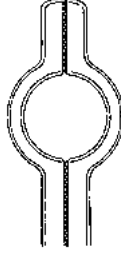

1156-3404
20,0 cm / 8"
30 Charr.

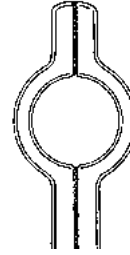

1156-3405
20,0 cm / 8"
32 Charr.

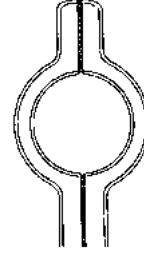

1156-3407
20,0 cm / 8"
36 Charr.

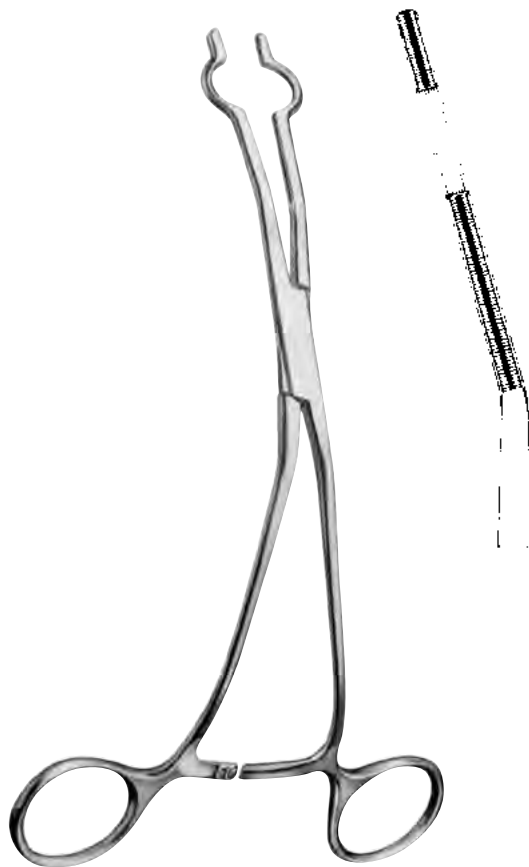

COOLEY

1156-3401 - 1156-3407

ATRAUMA

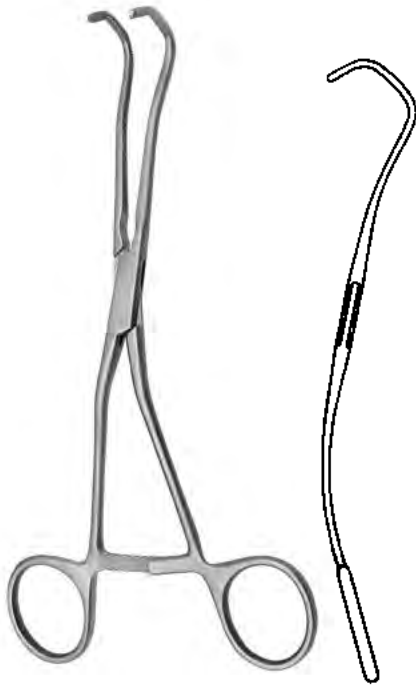

COOLEY-DERRA

1156-6316 - 1156-6318

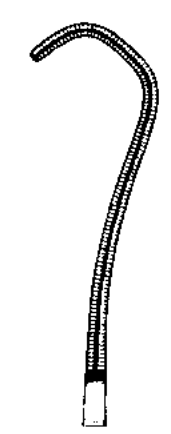

1156-6316
 16,5 cm / 6 1/2"

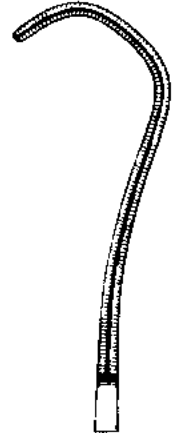

1156-6317
 17,0 cm / 6 3/4"

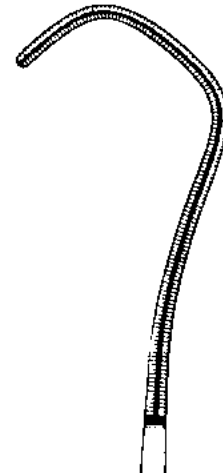

1156-6318
 17,5 cm / 7"

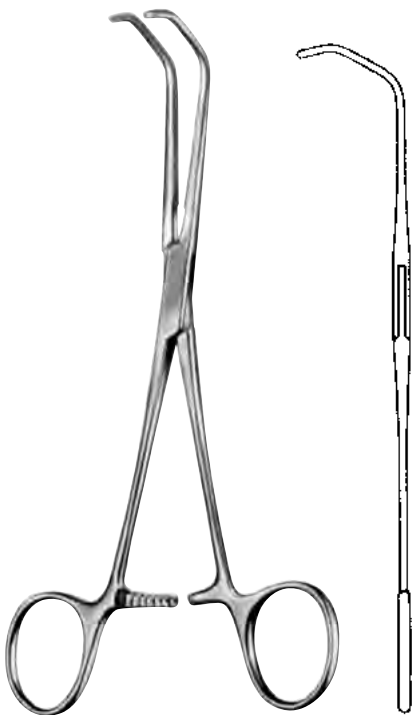

COOLEY-BECK

1156-6517 17,0 cm / 6 3/4"

ATRAUMA

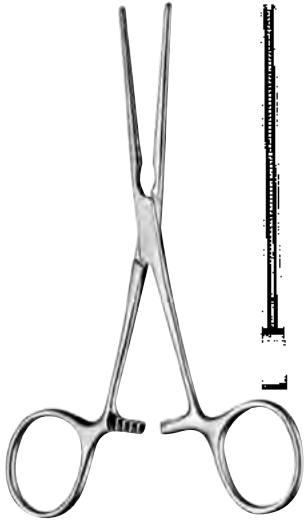

DEBAKEY
 1155-5412 13,0 cm / 5"

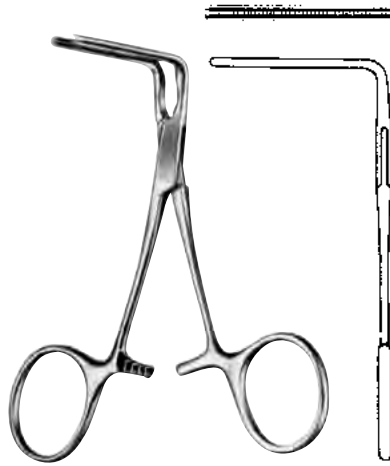

DEBAKEY
 1155-5710 10,0 cm / 4"

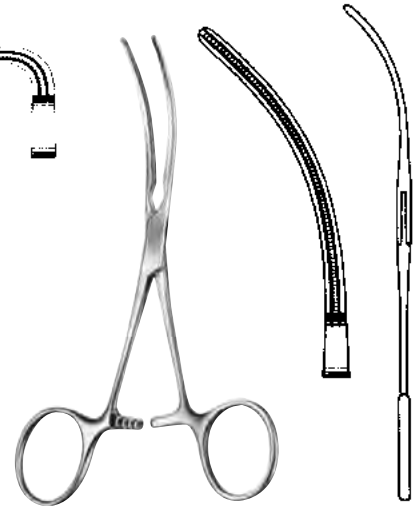

DEBAKEY
 1155-5511 12,5 cm / 5"



DEBAKEY
 1155-5912 12,5 cm / 5"

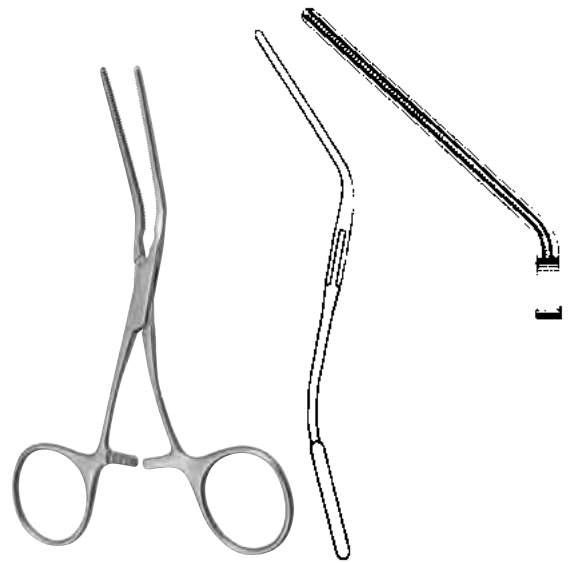

DEBAKEY
 1155-6113 12,5 cm / 5"

ATRAUMA



COOLEY

1156-6001

16,5 cm / 6 1/2"

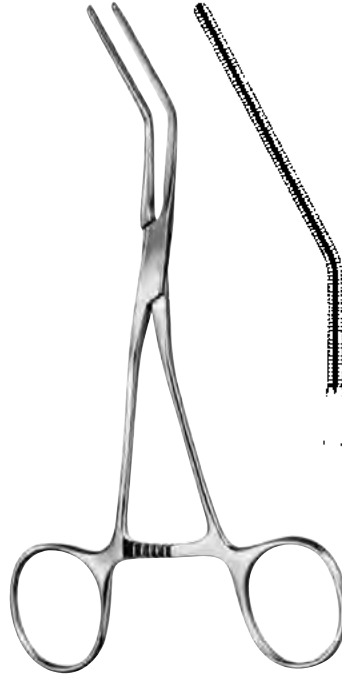

COOLEY

1156-6002

16,0 cm / 6 1/4"

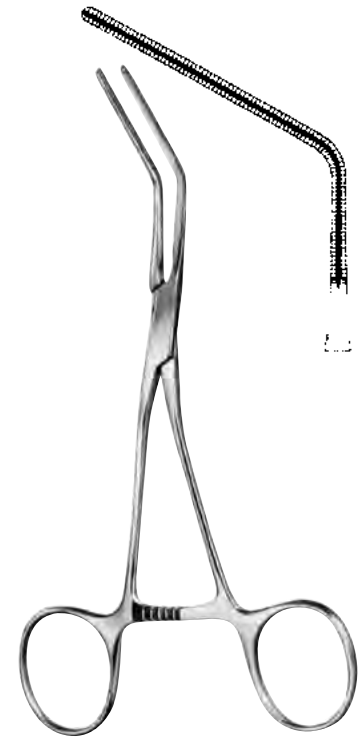

COOLEY

1156-6003

15,5 cm / 6"

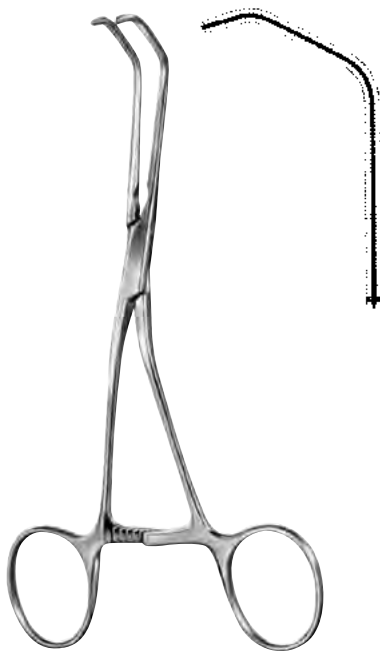

COOLEY

1156-6004

15,5 cm / 6"

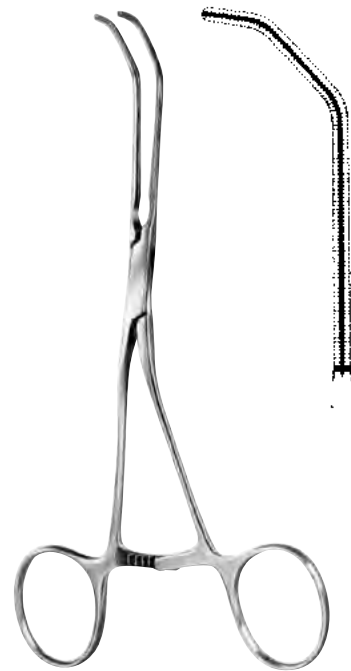

COOLEY

1156-6005

16,0 cm / 6 1/4"

ATRAUMA



1156-5401



1156-5402

COOLEY

1156-5401 - 1156-5402

14,0 cm / 5 1/2"

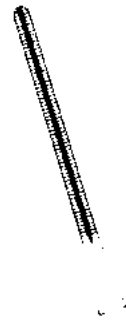
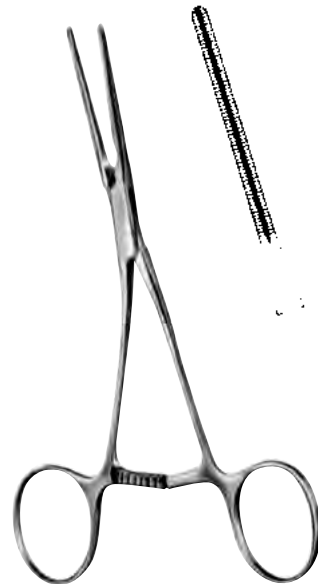

COOLEY

1156-5403

14,0 cm / 5 1/2"



COOLEY

1156-5404

14,0 cm / 5 1/2"



COOLEY

1156-5405

14,0 cm / 5 1/2"

ATRAUMA

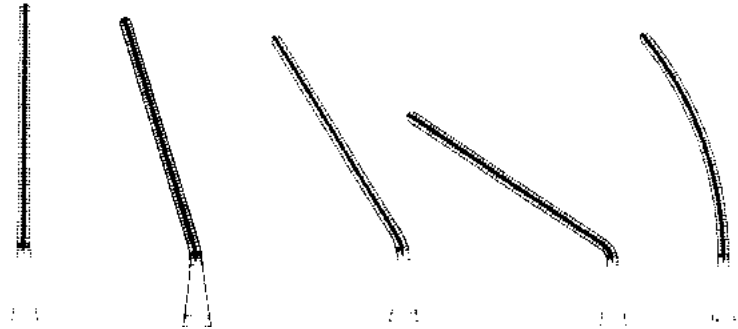

Fig.1	Fig.2	Fig.3	Fig.4	Fig.5
1156-5901	1156-5902	1156-5903	1156-5904	1156-5905
13,5 cm / 5 ¹ / ₄ "	13,5 cm / 5 ¹ / ₄ "	14,0 cm / 5 ¹ / ₂ "	13,5 cm / 5 ¹ / ₄ "	13,5 cm / 5 ¹ / ₄ "

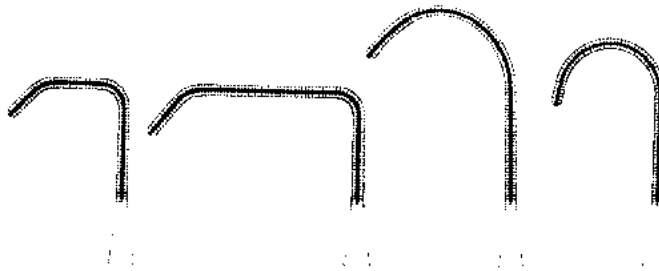
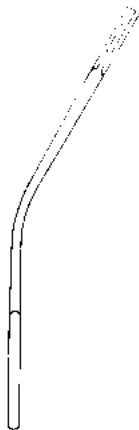

Fig.6	Fig.7	Fig.8	Fig.9
1156-5906	1156-5907	1156-5908	1156-5909
12,5 cm / 5"	13,0 cm / 5"	13,5 cm / 5 ¹ / ₄ "	13,0 cm / 5"



COOLEY
 1156-5901 - 1156-5909



Neonatal-Gefäßklemmen mit CASTA—EDA-Zahnung
Neonatal Vascular Clamps with Toothing CASTA—EDA
Pinzas vasculares para recién nacidos con dentado CASTA—EDA
Pinze vascolari per neonati con dentatura CASTA—EDA

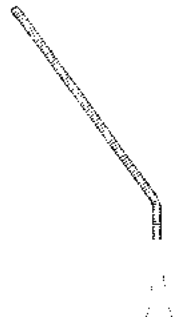

Fig.1
1155-4101
 12,5 cm / 5"

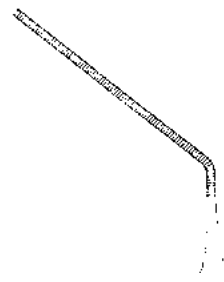

Fig.2
1155-4102
 11,5 cm / 4¹/₂"

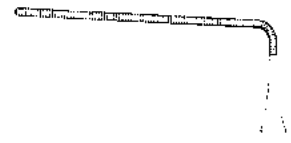

Fig.3
1155-4103
 11,0 cm / 4¹/₄"

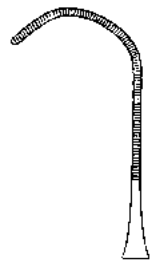

Fig.1
1155-4301
 11,5 cm / 4¹/₂"

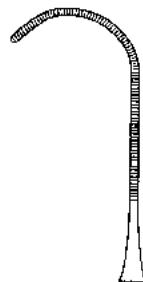

Fig.2
1155-4302
 12,0 cm / 4³/₄"

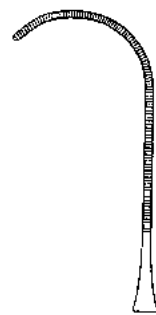

Fig.3
1155-4303
 12,0 cm / 4³/₄"

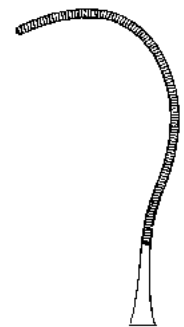
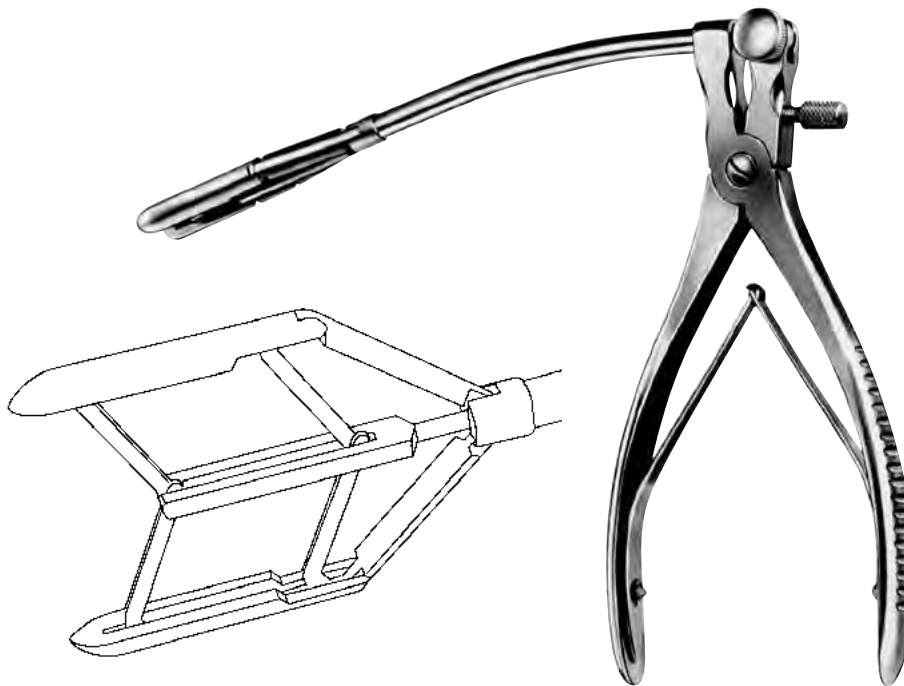

Fig.4
1155-4304
 12,0 cm / 4³/₄"



CASTAÑEDA
1155-4101 - 1155-4304



für Mitralstenosen
 for mitral stenosis
 para estenosis mitral
 per stenosi mitrali

Spreizweite 8-42 mm, mit Feststellschraube
 spreading 8-42 mm, with foxatopm screw
 abertura 8-42 mm, con tornillo de ajuste
 apertura totale 8-42 mm, con vite di fissazione

TUBBS

1310-3000

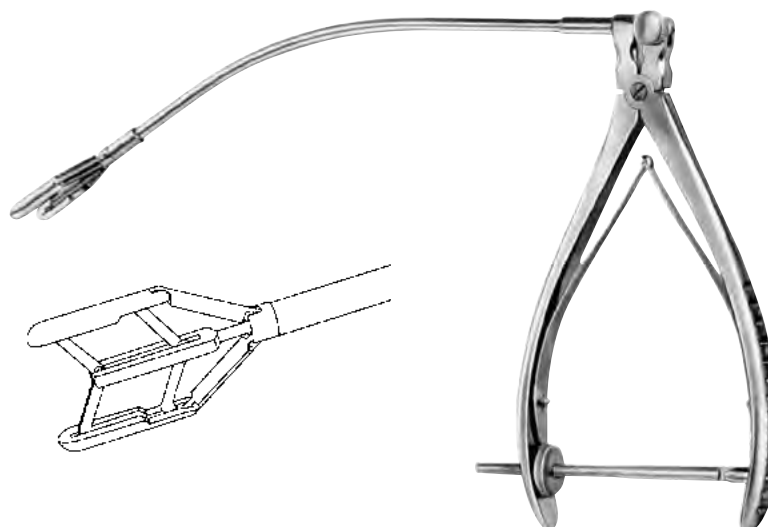

für Mitralstenosen
 for mitral stenosis
 para estenosis mitral
 per stenosi mitrali

Spreizweite 8-15 mm, mit Gewindesperre
 spreading 8-15 mm, with thread fixation
 abertura 8-15 mm, con fijación de rosca
 apertura totale 8-15 mm, con fissazione a filettatura

COOLEY

1310-3200

Aorta-Dilatatoren
Aortic Dilators
Dilatadores aórticos
Dilatatori per aorta

025



1310-1505 0,5 mm Ø	1310-1510 1,0 mm Ø	1310-1515 1,5 mm Ø	1310-1520 2,0 mm Ø
1310-1525 2,5 mm Ø	1310-1530 3,0 mm Ø	1310-1540 4,0 mm Ø	1310-1550 5,0 mm Ø

COOLEY

1310-1505 - 1310-1550 13,0 cm / 5"

1310-1905 0,5 mm Ø	1310-1910 1,0 mm Ø
1310-1915 1,5 mm Ø	1310-1920 2,0 mm Ø
1310-1925 2,5 mm Ø	1310-1930 3,0 mm Ø



1310-1805 0,5 mm Ø	1310-1810 1,0 mm Ø	1310-1815 1,5 mm Ø	1310-1820 2,0 mm Ø
1310-1825 2,5 mm Ø	1310-1830 3,0 mm Ø	1310-1835 3,5 mm Ø	1310-1840 4,0 mm Ø
1310-1845 4,5 mm Ø	1310-1850 5,0 mm Ø	1310-1870 7,0 mm Ø	1310-1890 9,0 mm Ø

DEBAKEY

1310-1805 - 1310-1890 19,0 cm / 7 1/2"



1310-1935 3,5 mm Ø	1310-1940 4,0 mm Ø
1310-1945 4,5 mm Ø	1310-1950 5,0 mm Ø
1310-1970 7,0 mm Ø	1310-1990 9,0 mm Ø

DEBAKEY

1310-1905 - 1310-1990 35,0 cm / 13 3/4"



Tunnelierschäfte
 Tunneling Shafts
 Vástagos para tunelar
 Gambi per tunnelare

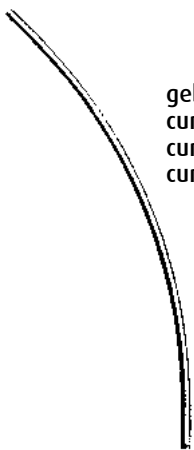

gebogen
 curved
 curva
 curvo

1310-4003
 12,5 cm / 5"

1310-4010
 24,5 cm



gerade
 straight
 recto
 diritto

1310-4004
 24,5 cm

gebogen
 curved
 curva
 curvo

MARTIN

1310-4000

Satz komplett mit 3 Schäften, 2 Griffen und 12 Aufsätzen im Lagerungsbehälter
 complete set with 3 shafts, 2 handles and 12 tips in storage case
 juego completo con 3 vástagos, 2 mangos y 12 Cabezas en caja metálica
 Set completo, con 3 gambi, 2 manici con 12 raccordi in contenitore metallico

1310-4001

Halteplatte für Aufsätze
 Plate for Tips
 Soporte para cabezas
 Supporto per punte

1310-4002

Metallbehälter
 Metal Case
 Caja metálica
 Contenitore metallico



1310-4014
 6,0 mm Ø
 Schraubolive
 Screw Olive
 Oliva
 Oliva



1310-4016
 8,0 mm Ø
 Schraubolive
 Screw Olive
 Oliva
 Oliva



1310-4010

Schraubadapter für Venen
 Vein Tip
 Cabeza para venas
 Tata adattatore veni

mit Knopf, Luer-Lock Ansatz
 with button, Luer Lock cone
 con botón, cono Luer-Lock
 con bottone, cono Luer-Lock



1310-4011

Luer-Schraubadapter
 Luer Adaptor
 Adaptador Luer
 Adattatore Luer

Luer-Lock Ansatz
 Luer-Lock cone
 cono Luer-Lock
 cono Luer-Lock



1310-4012

10,0 cm / 4"

Schraubenschlüssel
 Wrench
 Llave horquilla
 Giravite

1310-4013

55,5 cm

Tunnelierschaft
 Tunneling Shaft
 Vástago para tunelar
 Gambo per tunnelare

gebogen
 curved
 curvo
 curvo



1310-4017
 10,0 mm Ø
 Schraubolive
 Screw Olive
 Oliva
 Oliva



1310-4018
 12,0 mm Ø
 Schraubolive
 Screw Olive
 Oliva
 Oliva

Intimaspatel, Gefäßdissektoren
Intima Spatulas, Vascular Dissectors
Espátulas para la íntima, Disecadores vasculares
Spatole per intima, Dissettori vascolari

025

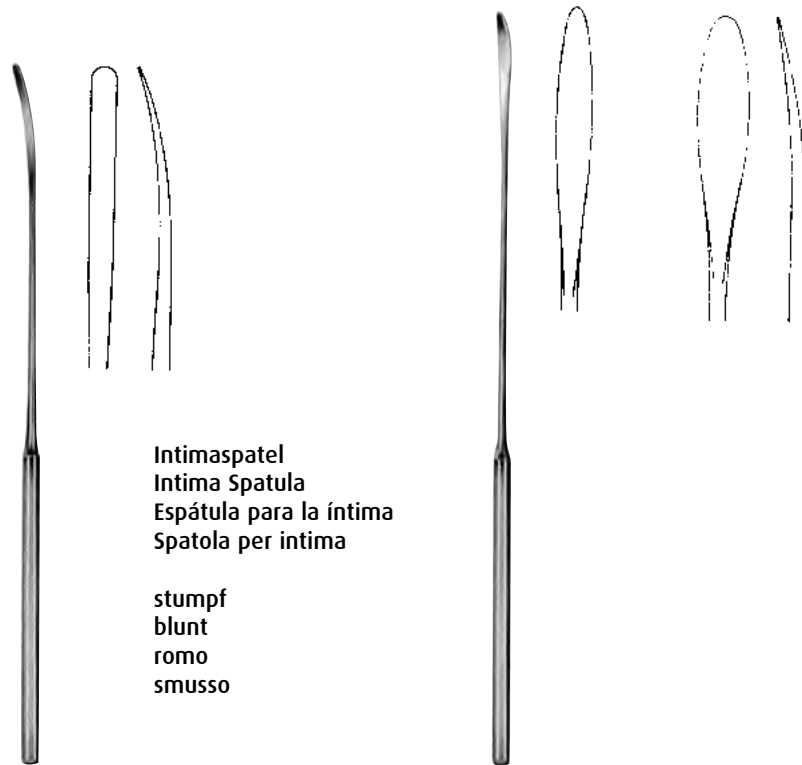

1311-0718 18,5 cm / 7¹/₄"
1311-0721 21,5 cm / 8¹/₂"

1311-0814 14,0 cm / 5¹/₂"
1311-0823 23,5 cm / 9¹/₄"

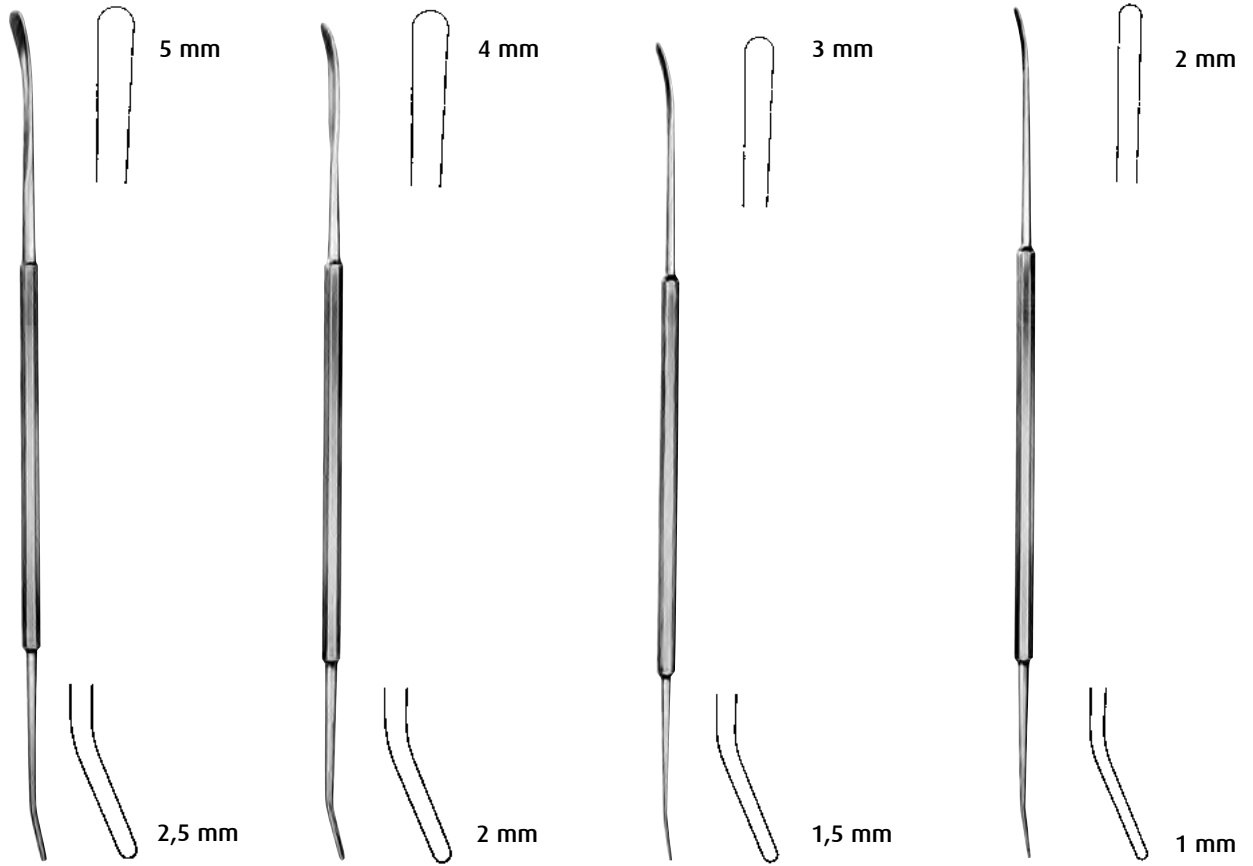

ROBB

1311-1301 24,0 cm / 9½"
 Fig. 1

ROBB

1311-1302 24,0 cm / 9½"
 Fig. 2

ROBB

1311-1303 24,0 cm / 9½"
 Fig. 3

ROBB

1311-1304 24,0 cm / 9½"
 Fig. 4

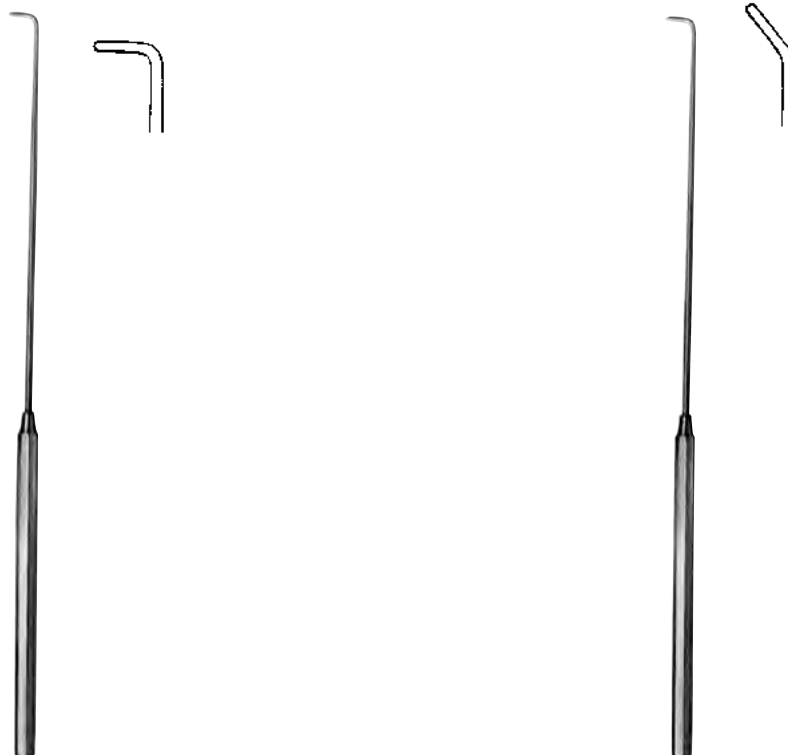

CRILE

1312-0020 20,0 cm / 8"

CRILE

1312-0205 20,5 cm / 10¼"

Nervhäkchen, Tourniquets
Nerve Hooklets, Tourniquets
Ganchitos para nervios, Tourniquetes
Uncini per nerve, Tornichetti

025

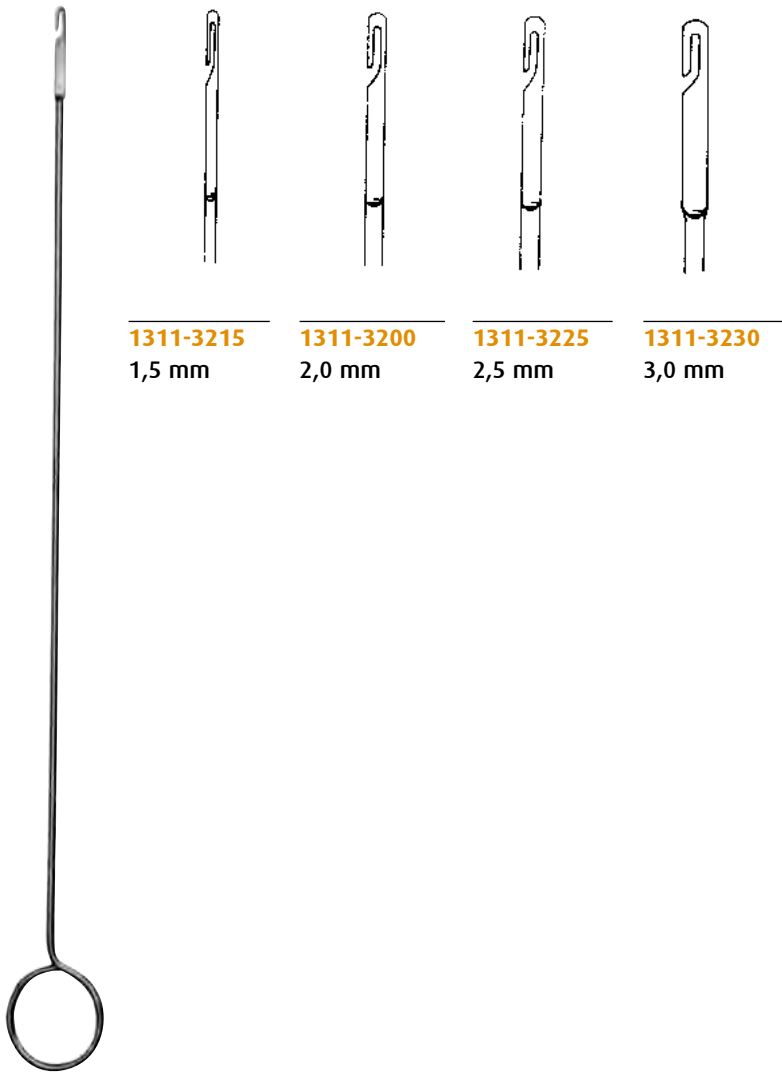

1311-3215	1311-3200	1311-3225	1311-3230
1,5 mm	2,0 mm	2,5 mm	3,0 mm

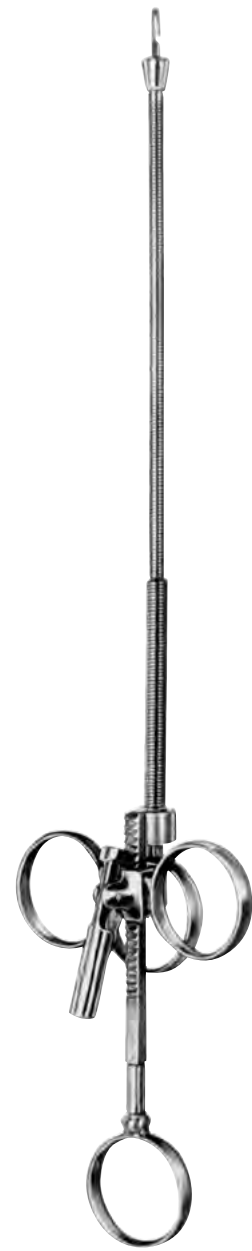

RUMEL-BELMONT		
1311-3032	27,0 cm / 10 ³ / ₄ "	3,2 mm Ø
1311-3064	33,0 cm / 13"	6,4 mm Ø

1311-3215 - 1311-3230 26,0 cm / 10"

026

Neurochirurgie, Laminektomie
Neurosurgery, Laminectomy
Neurocirugía, Laminectomía
Neurochirurgia, Laminectomia



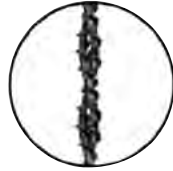
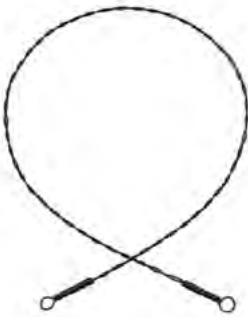

2-teilig
 2 wires twisted
 2 vueltas de hilo
 2-girate

OLIVECRONA

1401-3030	30,0 cm / 12"
1401-3040	40,0 cm / 16"
1401-3050	50,0 cm / 20"
1401-3060	60,0 cm / 24"
1401-3070	70,0 cm / 28"

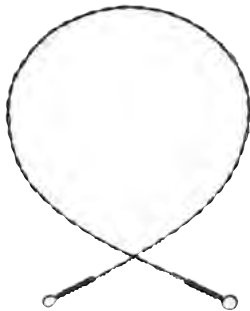

fein, 6-teilig
 fine, 6 wires twisted
 fina, 6 vueltas de hilo
 fino, 6-girate

GIGLI

1401-3230	30,0 cm / 12"
1401-3240	40,0 cm / 16"
1401-3250	50,0 cm / 20"



GIGLI

1401-3500	7,0 cm / 2 1/4"
-----------	-----------------

Einführungsinstrument für Drahtsägen
 Conductor for wire saws
 Conductor para sierras de hilo
 Introduttore per fili per sega



DE MARTEL

1201-5833	33,0 cm / 13"
-----------	---------------

Schädelhalter
Cervical Traction Tongs
Estribos de tracción craneal
Pinze per trazione craniale

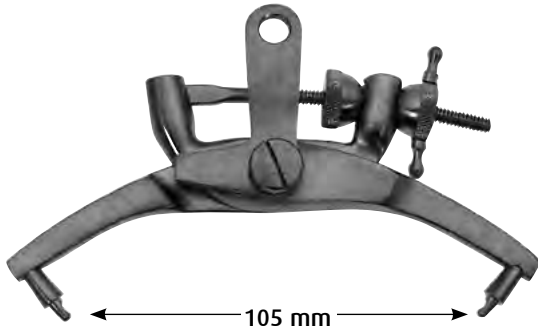

CRUTCHFIELD
1201-5001

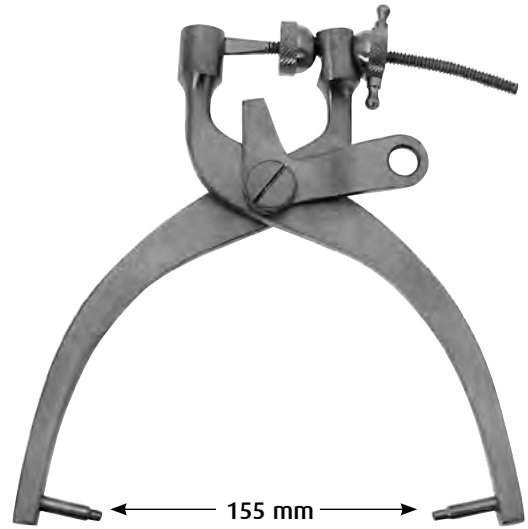

CRUTCHFIELD
1201-5002



CRUTCHFIELD
1201-5235 Ø 3,5 mm



CRUTCHFIELD
1201-5250 Ø 5,0 mm

Vorbohrer für CRUTCHFIELD-Schädelhalter
 Drill point for CRUTCHFIELD cervical traction tongs
 Perforador inicial para pinzas de tracción craneal CRUTCHFIELD
 Alesatore per pinze per trazione craniale di CRUTCHFIELD



1201-5100
 Ersatzdorn
 Spare pin
 Espina de repuesto
 Punta di ricambio

1201-5003

Schädelhalter für Extension der Halswirbel,
 großes Modell, Dorne verstellbar, deshalb
 Vorbohren nicht erforderlich

Cervical traction tongs, for extension of the
 neck vertebrae, large size, pins adjustable
 hence no initial drilling

Pinza de tracción craneal para la extensión
 de las vertebrae de cuello, tamaño grande,
 puntas ajustables suprimiendo perforaciones
 iniciales

Pinza per trazione craniale e l'estensione delle
 vertebre del collo, modello grande, punte
 regolabili al fine di evitare la perforazione iniziale



DAHLGREN

1204-5420 20,0 cm / 8"



1204-5421

Schädelstanze
Cranial rongeur
Pinza saca-bocado craneal
Pinza per cranio

Schädelstanzzange
Cranial punch rongeur
Pinza saca-bocados craneal
Pinza per cranio



CONE

1201-5722 22,5 cm / 9"



DE VILBISS

1201-5621 21,0 cm / 8¹/₄"



Fig. 4

1201-5622



Fig. 5

1201-5623

Schädelstanze
Cranial rongeur
Pinza saca-bocado craneal
Pinza per cranio

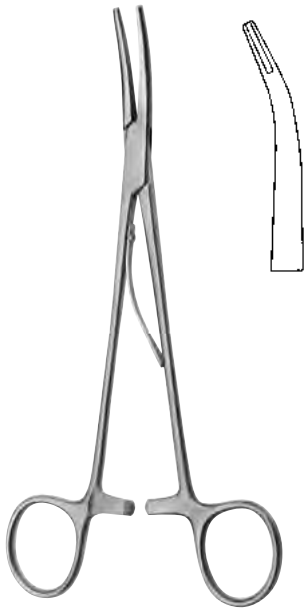

MC KENZIE

1201-3715 15,5 cm / 6"
1201-3719 18,5 cm / 7¹/₄"

Klammer-Anlegezange für Silberklammern
 Clip applying forceps for silver clips
 Pinza para aplicar las grapas de plata
 Pinza per applicare le agrafe in argento

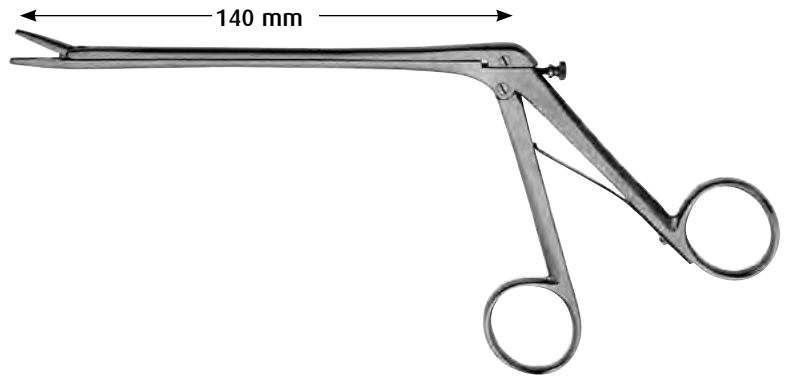

OLIVECRONA-TOENNIS

1201-4014



MC KENZIE

1201-3401 148 x 40 x 6 mm

Klammerblock mit 1 Klammernbügel und
 1 Schiebedeckel
 Silver clip carrier with 1 clip holding rack and
 1 sliding cover
 Porta-grapas con 1 riel para grapas y
 1 tapa corrediza
 Supporto porta-agrafe, con 1 fila di agrafe
 e 1 copertura a scorrimento



MC KENZIE

1201-3300

Silberklammern in Plastikbehälter,
 zu 100 Stück
 Silver clips in plastic vial,
 comprising 100 pieces
 Grapas de plata en tubo de plástico,
 conteniendo 100 piezas
 Agrafe di argento, contenuti in piccoli tubi
 di materiale plastico,
 100 pezzi per tubo

**KÖLNER****1201-3200**

Kopfhautklammern, in Packungen zu 50 Stück
 Scalp hemostasis clips, in packages of 50 pieces
 Grapa hemostática para cuero cabelludo, en
 paquetes de 50 piezas

Agrafes emostatici per cuoio capelluto in confezioni
 da 50 pezzi

**RANEY****1201-3100**

Kopfhautklammern
 Scalp hemostasis clips
 Grapa hemostática para cuero cabelludo
 Agrafes emostatici per cuoio capelluto



YASARGIL	L
1201-2607	31,0 cm / 12 ¹ / ₄ "
1201-2609	41,0 cm / 16 ¹ / ₄ "

**RANEY****1201-3000** 16,0 cm / 6¹/₄"

Anlege- und Abnehmezange
 für Kopfhautklammern

Applying an removing forceps
 for scalp hemostasis clips

Pinza para aplicar y quitar clips
 hemostáticas de cuero cabelludo

Pinza per applicare e togliere le agrafes
 emostatiche al cuoio capelluto

Federhaken zur Galea-Fixation mit Bulldog-klemme zum Befestigen
 am Abdecktuch.

Spring hooks for galea fixation with bulldog clamp, to be
 fastened to covering drape.

Ganchos con muelle para la fijación de la galea, con pinza de
 bulldog para agarrar tela

Ganci a molla per fissare la galea con clamp bulldog, da applicare
 al telo di copertura

Retraktoren zur Fixation am Schädel
Self-Retaining Retractors, for Skull Mounting
Separadores para la fijación del cráneo
Autofissator per retrattori, per il supporto del cranio

026



LEYLA

1201-0011

Selbsthaltender Spatel mit 1 Spannarm, komplett, bestehend aus:

- 1 Spannarm, flexibel (1201-0008)
- 1 Fixiervorrichtung für 1 Spannarm (1201-0005)
- 1 Spatelhalter für flache Spatel (1201-0009)

Self-retaining retractor with 1 arm, complete, consisting of:

- 1 Flexible arm (1201-0008)
- 1 Fixation base for 1 arm (1201-0005)
- 1 Support for flat spatulas (1201-0009)

Separador automático con 1 brazo, completo, compuesto de:

- 1 Brazo, flexible (1201-0008)
- 1 Fijador para 1 brazo (1201-0005)
- 1 Porta-espátula para espátulas planas (1201-0009)

Autofissatore per retrattore con 1 braccio, completo, composto da:

- 1 Braccio flessibile (1201-0008)
- 1 Base di fissaggio per 1 braccio (1201-0005)
- 1 Supporto per spatole cervicali piatte (1201-0009)

LEYLA

1201-0012

Selbsthaltender Spatel mit 2 Spannarm, komplett, bestehend aus:

- 2 Spannarm, flexibel (1201-0005)
- 1 Fixiervorrichtung für 2 Spannarme (1201-0006)
- 2 Spatelhalter für flache Spatel (1201-0009)

Self-retaining retractor with 2 arm, complete, consisting of:

- 2 Flexible arms (1201-0005)
- 1 Fixation base for 2 arms (1201-0006)
- 2 Supports for flat spatulas (1201-0009)

Separador automático con 2 brazos, completo, compuesto de:

- 2 Brazos, flexible (1201-0005)
- 1 Fijador para 2 brazos (1201-0006)
- 2 Porta-espátula para espátulas planas (1201-0009)

Autofissatore per retrattore con 2 bracci, completo, composto da:

- 2 Bracci flessibili (1201-0005)
- 1 Base di fissaggio per 2 bracci (1201-0006)
- 2 Supporti per spatole cervicali piatte (1201-0009)

**LEYLA****1201-0008**

Spannarm
 Flexible arm
 Brazo flexible
 Braccio flessibile

**LEYLA****1201-0005**

Fixiervorrichtung für 1 Spanner
 Fixation base for 1 arm
 Fijador para 1 brazo
 Base di fissaggio per 1 braccio

**LEYLA****1201-0006**

Fixiervorrichtung für 2 Spannarme
 Fixation base for 2 arms
 Fijador para 2 brazos
 Base di fissaggio per 2 bracci

**LEYLA****1201-0007**

Fixiervorrichtung für 1 Spannarm
 Fixation base for 1 arm
 Fijador para 1 brazo
 Base di fissaggio per 1 braccio

**LEYLA****1201-0010**

Spatelhalter
 Support
 Porta-espátula
 Supporto

**LEYLA****1201-0009**

Spatelhalter
 Support
 Porta-espátula
 Supporto

Retraktoren zur Fixation am OP-Tisch
Self-Retaining Retractors, Fixation to Operating Table
Separadores para fijación a la mesa de operaciones
Autofissatori per retrattori, da fissare alla tavola operatoria

026



LEYLA

1201-0000

Selbsthaltender Spatel mit 1 Spannarm, komplett, bestehend aus:

- 1 Kugelgelenkkloben (1201-0001)
- 1 Haltearm (1201-0002)
- 1 Kupplungskopf (1201-0003)
- 1 Spannarm (1201-0008)
- 1 Spatelhalterung für Spatel mit rundem Griff (1201-0010)

Self-retaining retractor with 1 flexible arm, complete, consisting of:

- 1 Ball and socket joint (1201-0001)
- 1 Holding rod (1201-0002)
- 1 Coupling head (1201-0003)
- 1 Flexible arm (1201-0008)
- 1 Support, for spatulas with round shaft (1201-0010)

Separador automático con 1 brazo, completo, compuesto de:

- 1 Articulación esférica (1201-0001)
- 1 Brazo de apoyo (1201-0002)
- 1 Acoplamiento (1201-0003)
- 1 Brazo (1201-0008)
- 1 Porta-espátula para espátulas con mangos redondos (1201-0010)

Autofissatore per retrattori con 1 braccio flessibile completo, composto da:

- 1 Giunto a sfera ad incastro (1201-0001)
- 1 Porta asta (1201-0002)
- 1 Testa accoppiamento (1201-0003)
- 1 Braccio flessibile (1201-0008)
- 1 Supporto per spatola con albero rotondo (1201-0010)

LEYLA

1201-1000

Selbsthaltender Spatel mit 2 Spannarmen, komplett, bestehend aus:

- 1 Kugelgelenkkloben (1201-0001)
- 1 Haltearm (1201-0002)
- 1 Kupplungsköpfe (1201-0003)
- 2 Spannarme (1201-0008)
- 2 Spatelhalterung, für flache Spatel (1201-0009)
- 1 Spatel (1201-1609)
- 1 Spatel (1201-1612)

Self-retaining retractor with 2 flexible arms, complete, consisting of:

- 1 Ball and socket joint (1201-0001)
- 1 Holding rod (1201-0002)
- 1 Coupling heads (1201-0003)
- 2 Flexible arms (1201-0008)
- 2 Supports, for flat spatulas (1201-0009)
- 1 spatulas (1201-1609)
- 1 spatulas (1201-1612)

Separador automático con 2 brazos, completo, compuesto de:

- 1 Articulación esférica (1201-0001)
- 1 Brazo de apoyo (1201-0002)
- 1 Acoplamientos (1201-0003)
- 2 Brazos (1201-0008)
- 2 Porta-espátula, para espátula planas (1201-0009)
- 1 Espatula (1201-1609)
- 1 Espatula (1201-1612)

Autofissatore per retrattori con 2 bracci flessibili completo, composto da:

- 1 Giunto a sfera ad incastro (1201-0001)
- 1 Porta asta (1201-0002)
- 1 Testa accoppiamento (1201-0003)
- 2 Bracci flessibili (1201-0008)
- 2 Supporti per spatola piatta (1201-0009)
- 1 Spatola (1201-1609)
- 1 Spatola (1201-1612)

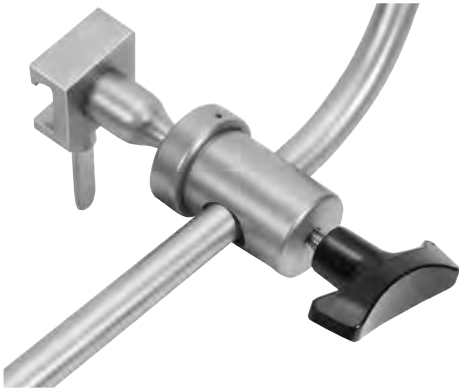

LEYLA

1201-0001

Kugelgelenkkloben
 Ball and socket joint
 Articulación esférica
 Giunto a sfera ad incastro



LEYLA

1201-0002

Haltearm
 Holding rod
 Brazo
 Porta asta

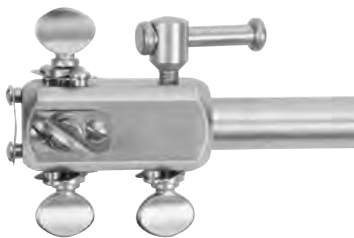

LEYLA

1201-0003

Kupplungskopf
 Coupling head
 Acoplamiento
 Testa accoppiamento



LEYLA

1201-0004

Kupplungskopf, drehbar
 Coupling head, turnable
 Acoplamiento, girable
 Testa accoppiamento, girabile

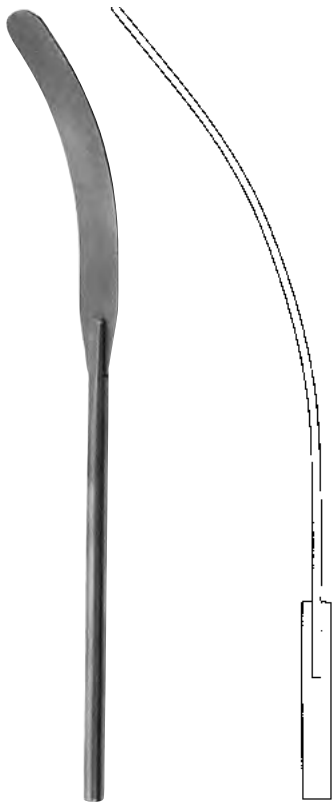

HEIFETZ

1201-2008	8 x 200 mm
1201-2011	11 x 200 mm
1201-2014	14 x 200 mm
1201-2017	17 x 200 mm
1201-2020	20 x 200 mm



HEIFETZ

1201-1508	8 x 155mm
1201-1511	11 x 155 mm
1201-1514	14 x 155 mm
1201-1517	17 x 155 mm



biegsam
malleable
maleable
flessibile

DAVIS

1201-1613	13 x 190 mm
1201-1616	16 x 190 mm



biegsam / gerieft
malleable / serrated
maleable / acanalada
flessibile / scannalato

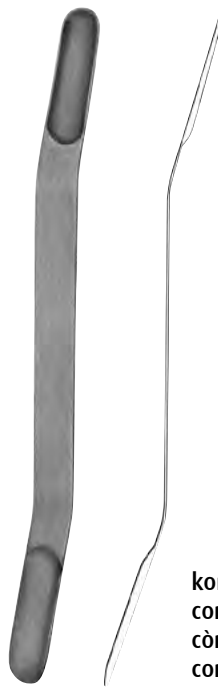

konkav
concave
còncava
concava

OLIVECRONA

1201-1609	9 x 200 mm
1201-1612	12 x 200 mm

1201-2407	7+ 9 mm x 180 mm
1201-2411	11+13 mm x 180 mm
1201-2415	15+18 mm x 180 mm
1201-2418	19+21 mm x 180 mm

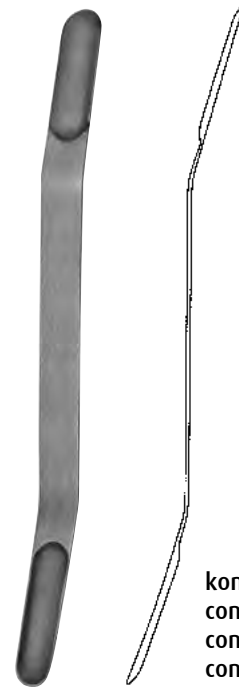

konvex
convex
convexa
convessa

OLIVECRONA

1201-2507	7+ 9 mm x 180 mm
1201-2511	11+13 mm x 180 mm
1201-2515	15+18 mm x 180 mm
1201-2518	19+21 mm x 180 mm

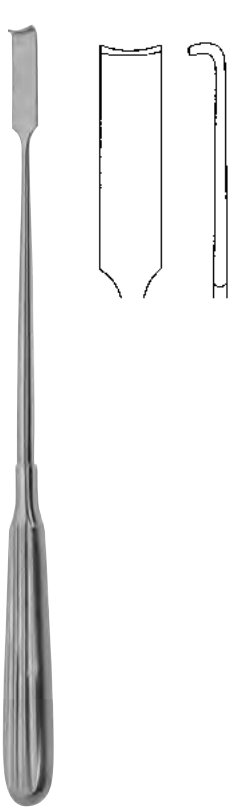
**SCOVILLE**

1201-7623 23,0 cm / 9"

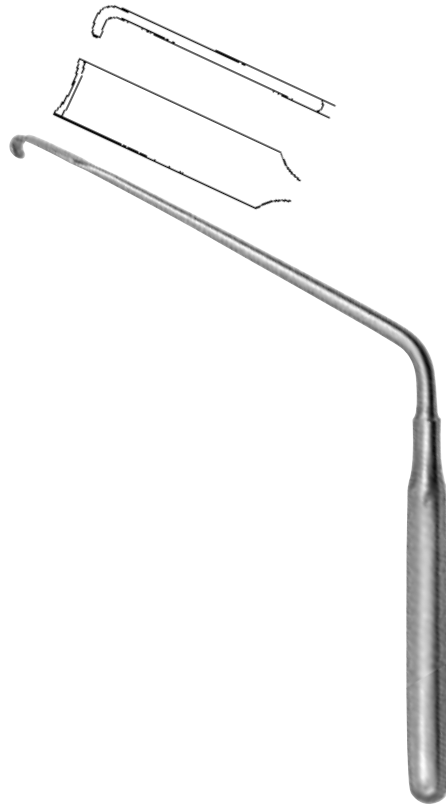
**SCOVILLE**

1201-7719 20,0 cm / 8"

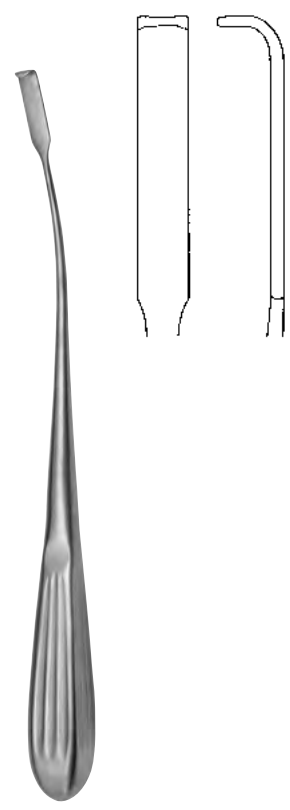
**HOLSHER**

1201-7924 24,0 cm / 9 1/2"

**LOVE**

1201-7201 19,0 cm / 7 1/2"

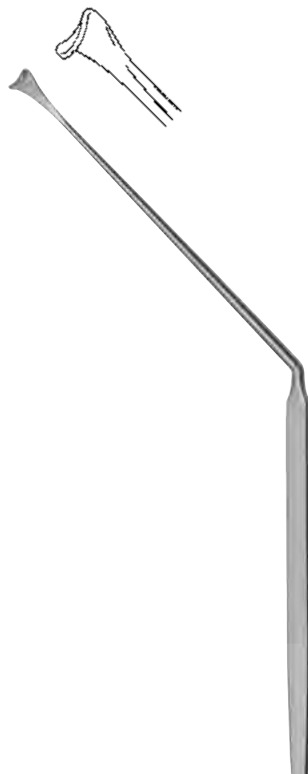
**LOVE**

1201-7202 18,0 cm / 7"

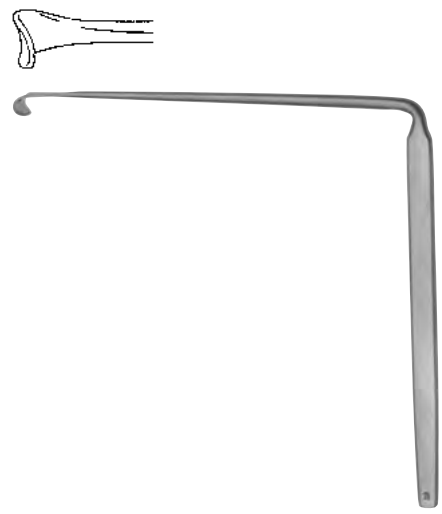
**LOVE**

1201-7203 14,0 cm / 5 1/2"

Nervwurzelhaken
Nerve Root Retractors
Separadores para la raíz de nervios
Seperatori per le radici dei nervi

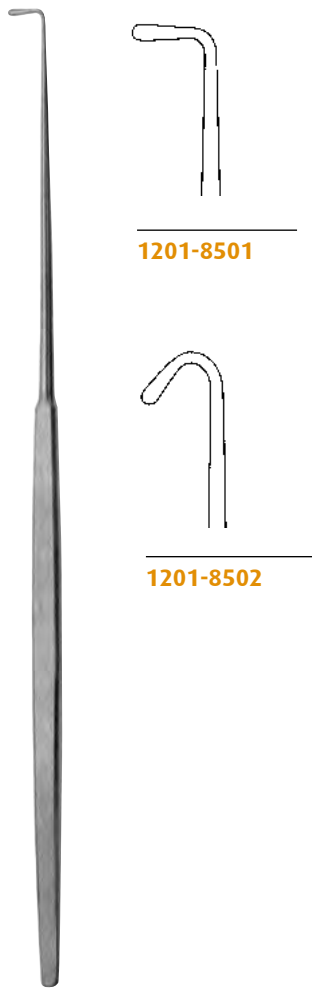

1201-8501

1201-8502

GRONINGEN

1201-8501 - 1201-8502 26,0 cm / 10¹/₄"



stumpf
blunt
romo
smusso

CUSHING

1161-0501 19,0 cm / 7¹/₂"
1161-0601 28,0 cm / 11"

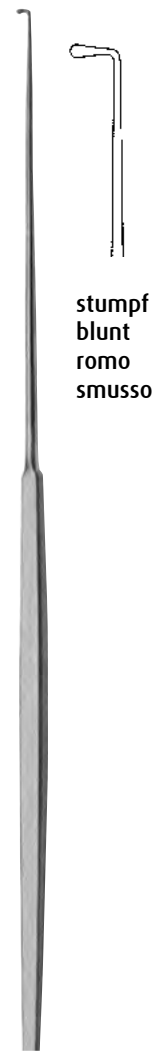

stumpf
blunt
romo
smusso

CUSHING

1161-0502 19,0 cm / 7¹/₂"
1161-0602 28,0 cm / 11"



DANDY

1201-8820 20,0 cm / 8¹/₂"

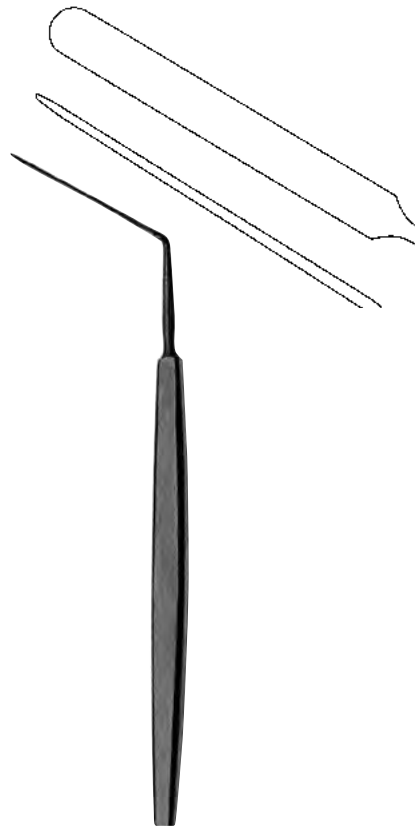

HORSLEY

1201-7520 20,0 cm / 7¹/₄"

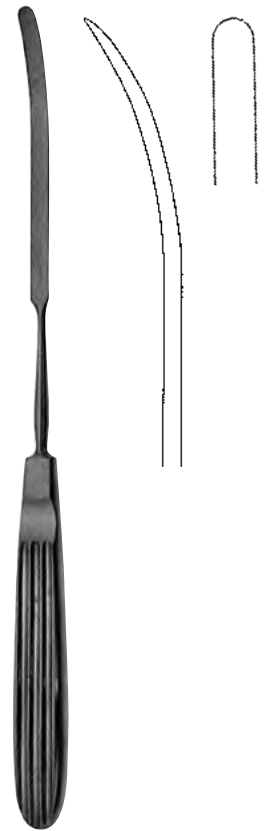

SACHS

1201-6306 21,0 cm / 9"



scharf
sharp
agudo
acuto

SACHS

1201-6303 21,0 cm / 8"

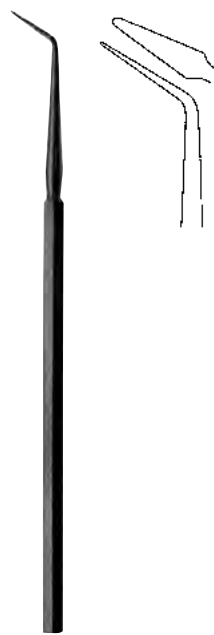

FRAZIER

1201-7001 16,5 cm / 6¹/₂"



MILLIGAN

1201-6721 21,0 cm / 8¹/₄"

Dura-Dissektoren
Dura-Dissectors
Disecadores de dura-madre
Dissettori per la dura-madre



DAVIS

1311-0924 24,5 cm / 9²/₃"



PENFIELD

1311-0001 17,5 cm / 7"



PENFIELD

1311-0002 19,5 cm / 7³/₄"



PENFIELD

1311-0003 19,5 cm / 7³/₄"



PENFIELD

1311-0004 21,5 cm / 8¹/₂"



PENFIELD

1311-0005 29,0 cm / 11¹/₂"



schmal
small
estrecho
stretto

TOENNIS

1311-1101 24,0 cm / 9 1/2"

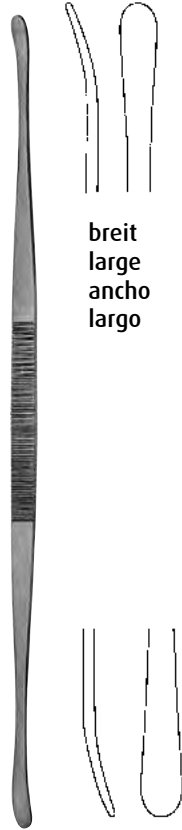

breit
large
ancho
largo

TOENNIS

1311-1102 24,0 cm / 9 1/2"

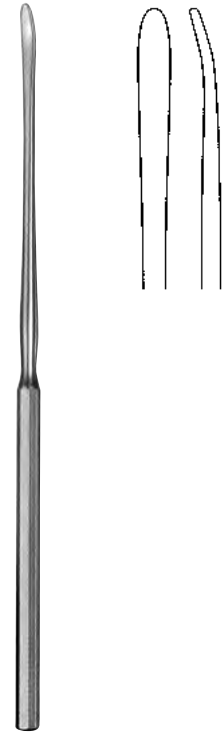

DAVIS

1312-1101 19,0 cm / 7 1/2"



schmall
small
estrecho
stretto

OLIVECRONA

1201-6018 18,0 cm / 7"
1201-6024 24,0 cm / 9 1/2"



breit
large
ancho
largo

OLIVECRONA

1201-6119 19,5 cm / 7 3/4"
1201-6124 24,0 cm / 9 1/2"

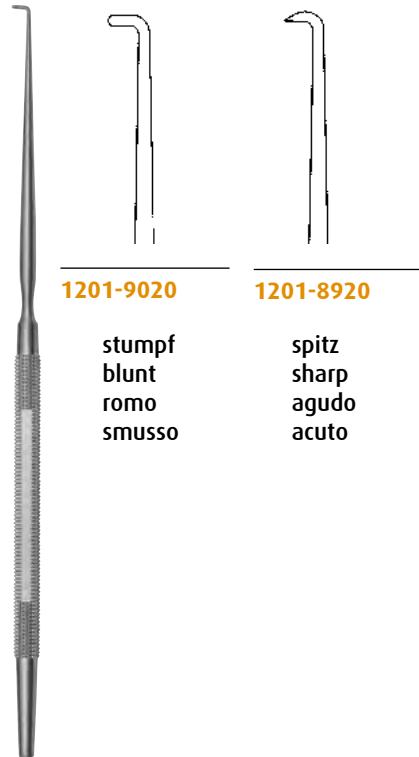

1201-9020

stumpf
blunt
romo
smusso

1201-8920

spitz
sharp
agudo
acuto

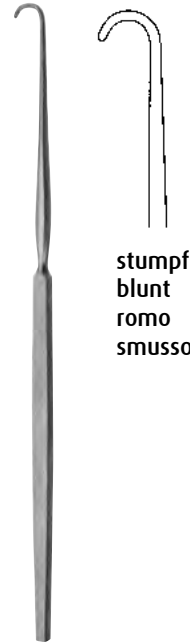

stumpf
blunt
romo
smusso



spitz
sharp
agudo
acuto

ADSON

1201-9020 - 1201-8920 20,0 cm / 8"

GRAHAM

1201-9116 16,5 cm / 6³/₄"

SACHS

1201-9218 18,5 cm / 7¹/₄"



spitz
sharp
agudo
acuto



stumpf
blunt
romo
smusso

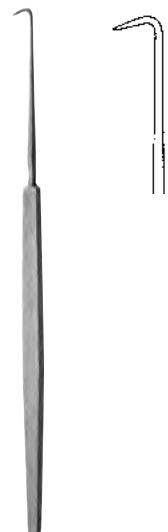

FRAZIER

1201-9513 13,0 cm / 5"
1201-9518 18,0 cm / 7"

FRAZIER

1201-9613 13,0 cm / 5"

CUSHING

1201-9414 14,0 cm / 5¹/₂"



TOENNIS

1201-9313 13,0 cm / 5¹/₈"



TOENNIS

1201-9319 19,0 cm / 7¹/₂"



HALLE

1201-9520 20,0 cm / 8¹/₄"

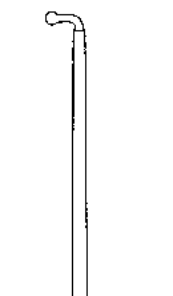

1316-8801

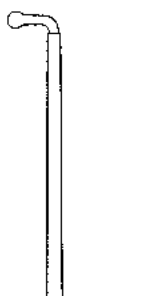

1316-8802

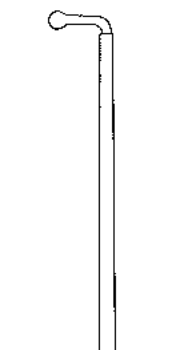

1316-8803

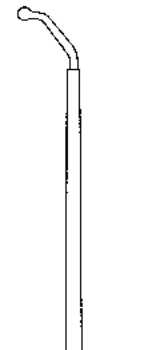

1316-8804

CASPAR

1316-8801 - 1316-8804 25,0 cm / 10"

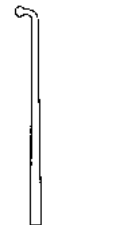

1316-7301

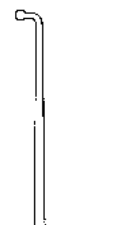

1316-7302

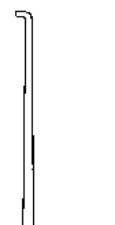

1316-7303



1316-7304

KRAYENBÜHL

1316-7301 - 1316-7304 18,5 cm / 7¹/₄"

Spekula für trans-sphenoidale Hypophysektomie
 Specula for trans-sphenoidal hypophysectomy
 Espéculo para la hipofisectomía trans-sfenoidal
 Speculo per ipofisectomía trans-sfenoidale



**LANDOLT-
CUSHING**

- 1269-0001** ø 15 mm x 70 mm
1269-0002 ø 15 mm x 90 mm

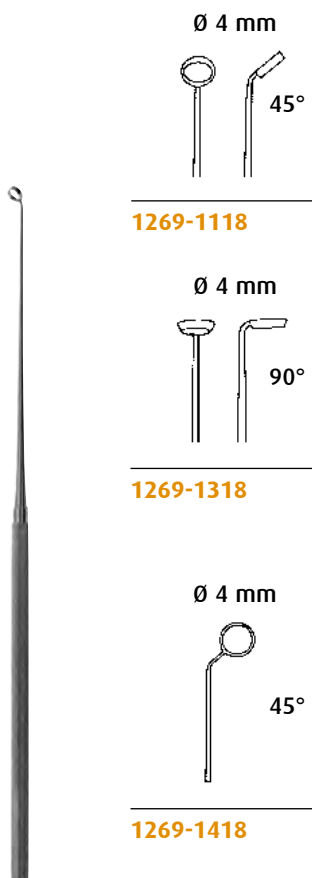

1269-1118

1269-1318

1269-1418

RAY

1269-1118 - 1269-1418 19,0 cm / 7 1/2"

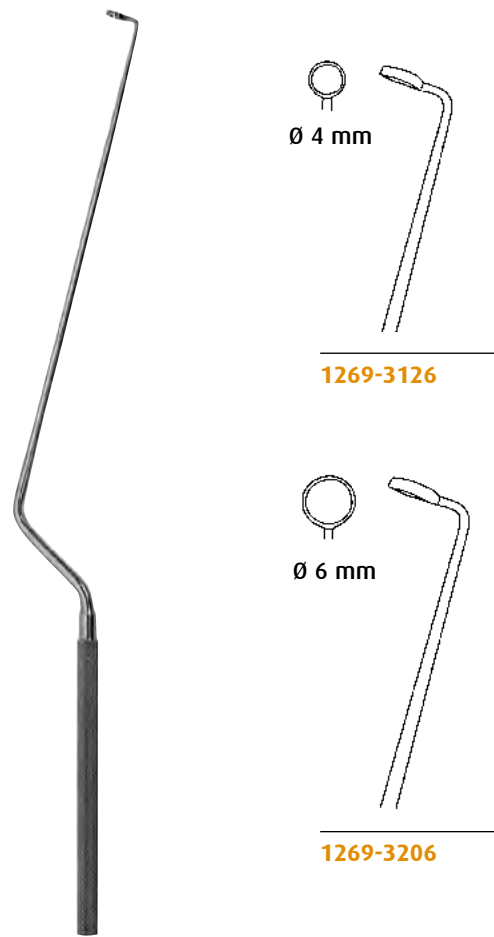

1269-3126

1269-3206

HARDY

1269-3126 - 1269-3206 26,0 cm / 10 1/4"

Küretten, horizontal 90°, biegsam
 Curettes, horizontal 90°, malleable
 Curetas, horizontal 90°, maleable
 Curette, orizzontale 90°, malleabile



stumpf
blunt
romo
smusso

HARDY

1269-2025

stumpf
blunt
romo
smusso

HARDY

1269-2125

scharf
sharp
agudo
acuto

HARDY

1269-2225

scharf
sharp
agudo
acuto

HARDY

1269-2325



HARDY

1269-0725

scharf
sharp
agudo
acuto

HARDY-FAHLBUSCH

1269-0925

scharf
sharp
agudo
acuto

HARDY-FAHLBUSCH

1269-0825

1269-2025 - 1269-0825

24,5 cm / 9³/₄"

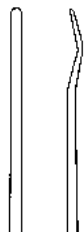

YASARGIL

1316-9201



YASARGIL

1316-9202



YASARGIL

1316-9203



YASARGIL

1316-9204



YASARGIL

1316-6904

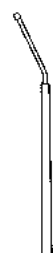

JACOBSON

1316-6418

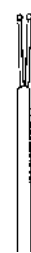

JACOBSON

1316-6518



YASARGIL

1316-6618

1316-9201 - 1316-6618

19,0 cm / 7¹/₂"

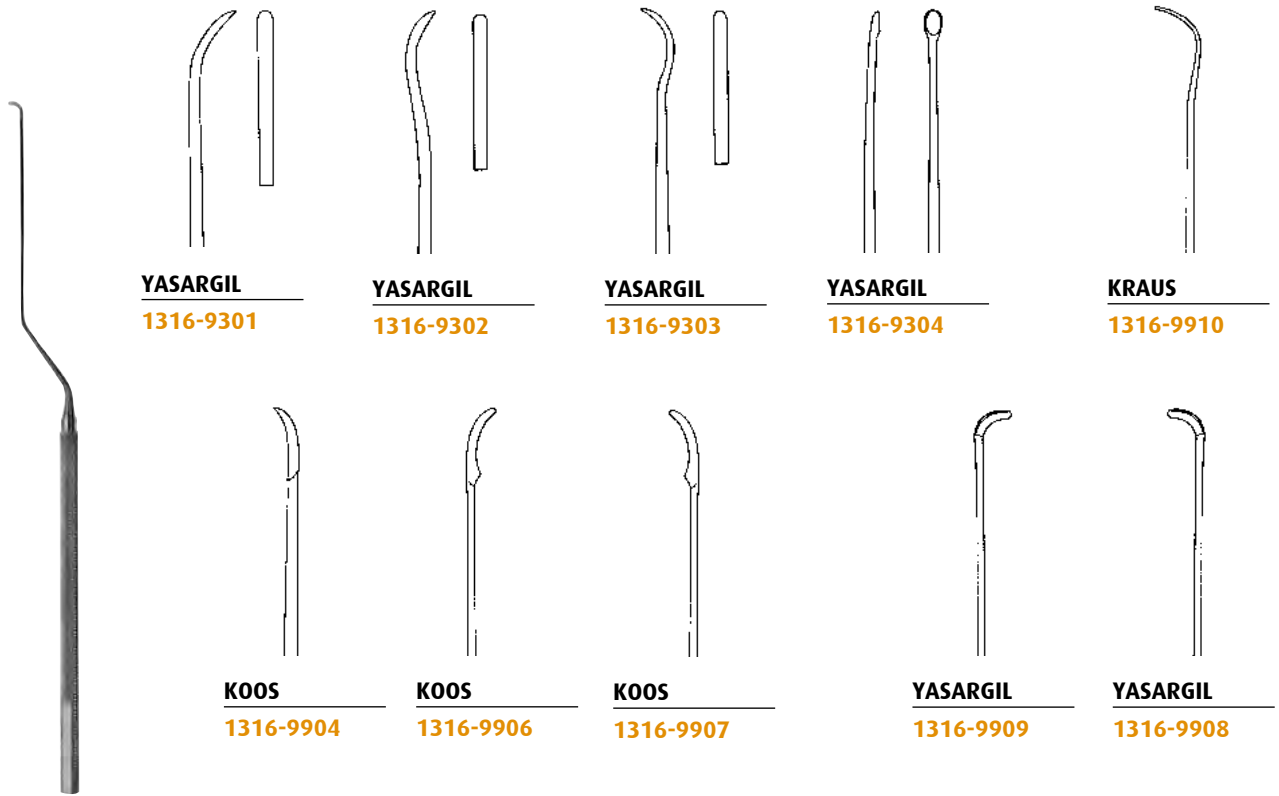

YASARGIL
1316-9301

YASARGIL
1316-9302

YASARGIL
1316-9303

YASARGIL
1316-9304

KRAUS
1316-9910

KOOS
1316-9904

KOOS
1316-9906

KOOS
1316-9907

YASARGIL
1316-9909

YASARGIL
1316-9908

1316-9301 - 1316-9908 19,0 cm / 7¹/₄"

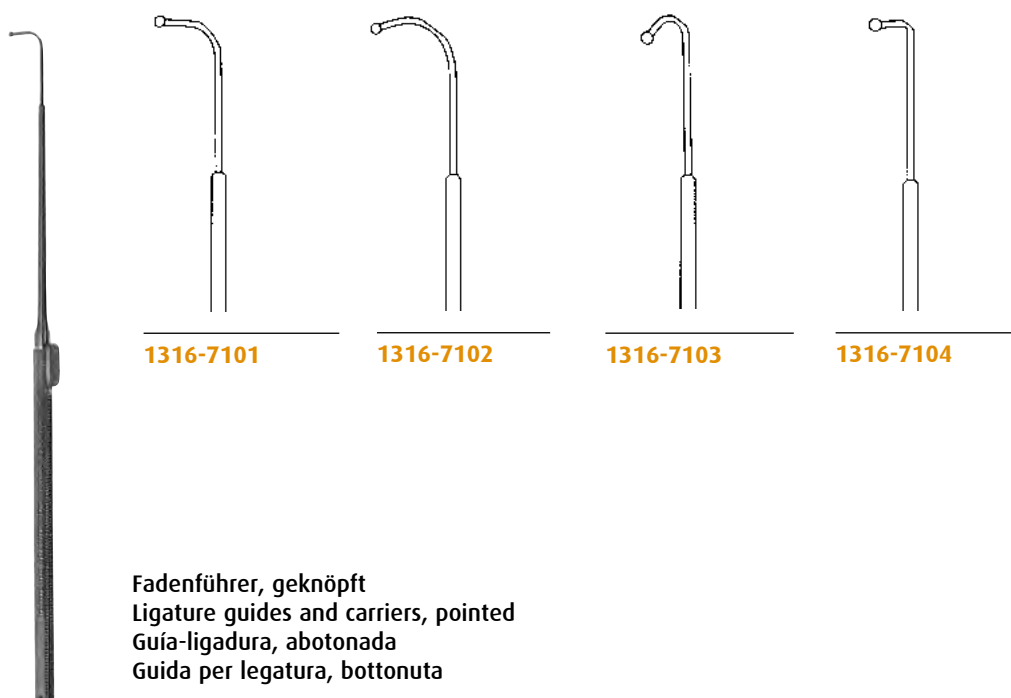

1316-7101

1316-7102

1316-7103

1316-7104

Fadenführer, geknöpft
 Ligature guides and carriers, pointed
 Guía-ligadura, abotonada
 Guida per legatura, bottonuta

YASARGIL

1316-7101 - 1316-7104 18,5 cm / 7¹/₄"



1316-8201



1316-8202

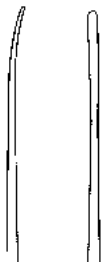

1316-8203

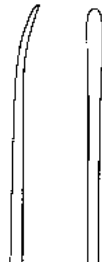

1316-8204

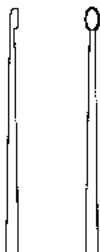

1316-8205



1316-8206

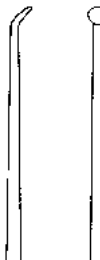

1316-8207

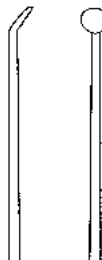

1316-8208



1316-8201 - 1316-8208

23,0 cm / 9"



1316-8101

Dissektor
 Dissector
 Disecador
 Dissettore

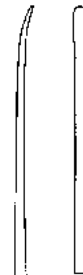

1316-8102

Dissektor
 Dissector
 Disecador
 Dissettore



1316-8103

Raspatorium
 Raspatory
 Legra
 Periostotomo



1316-8101 - 1316-8103

23,0 cm / 9"

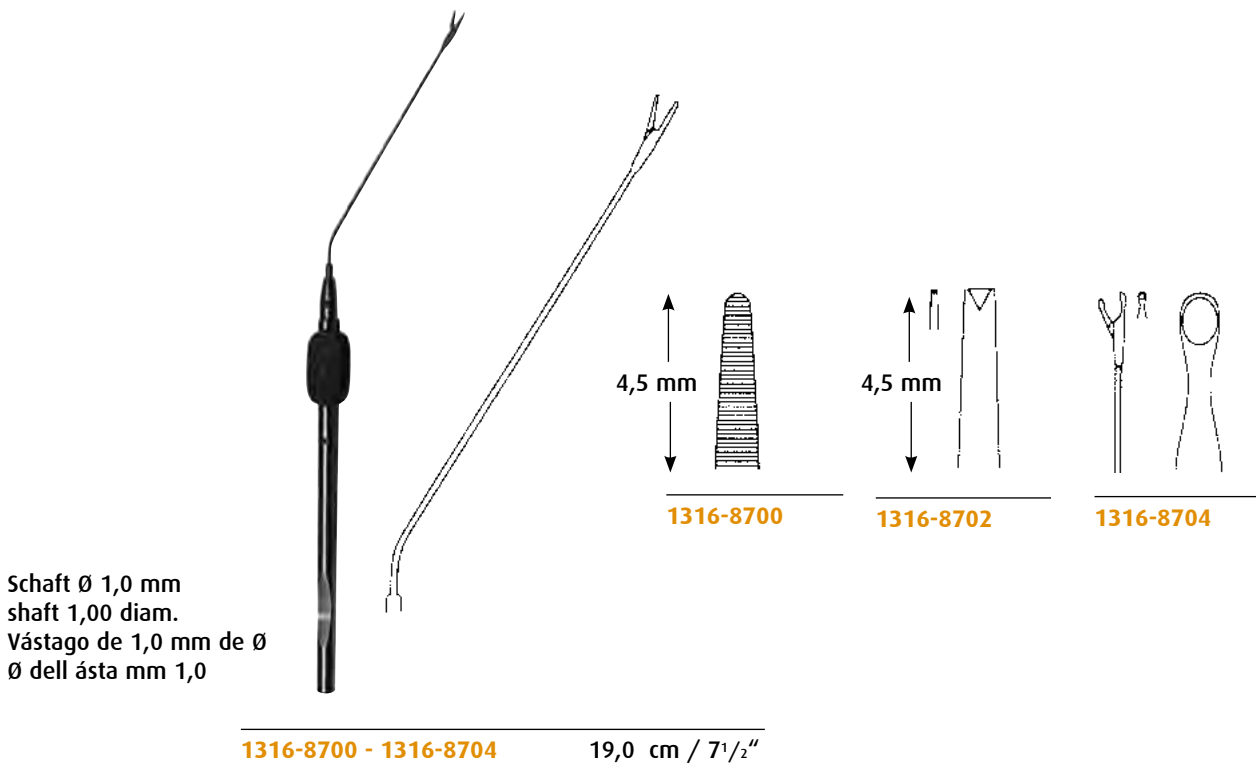
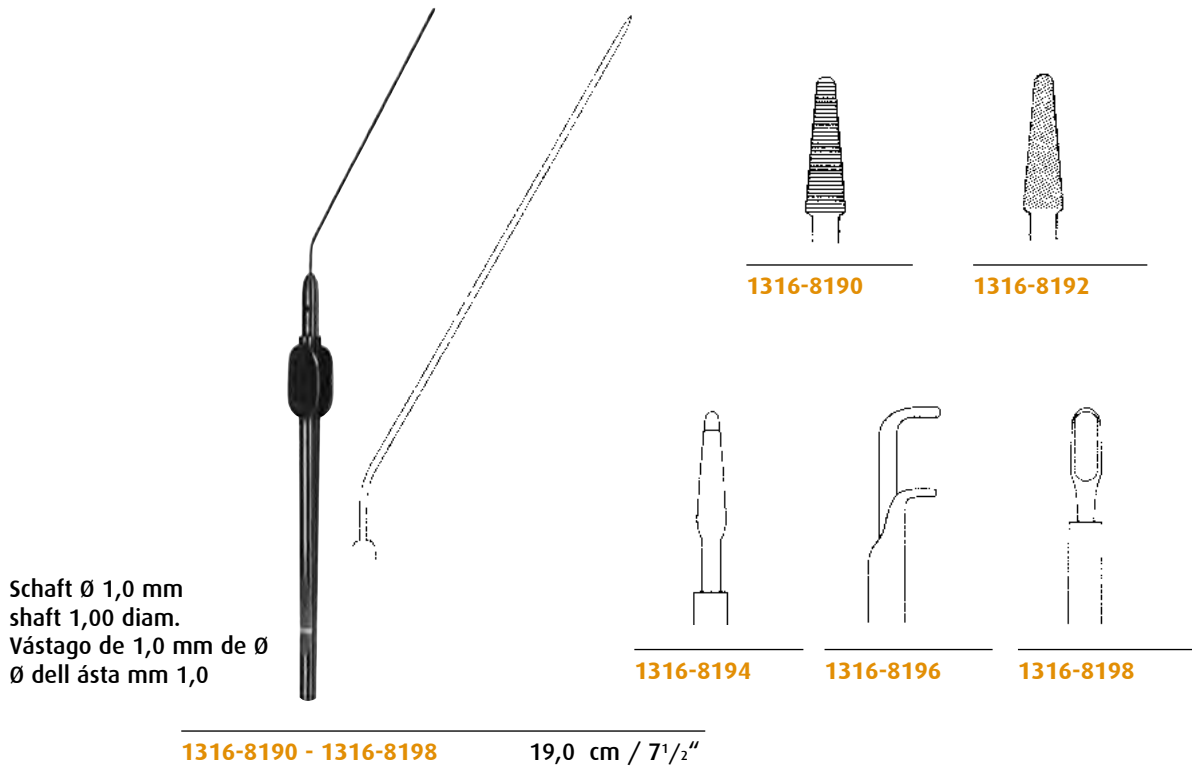

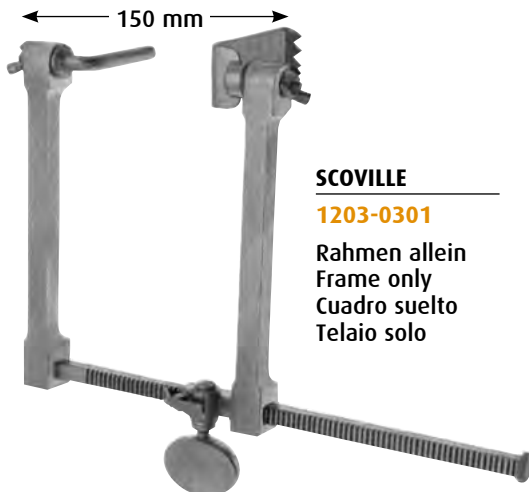
**SCOVILLE****1203-0301**

Rahmen allein
 Frame only
 Cuadro suelto
 Telaio solo

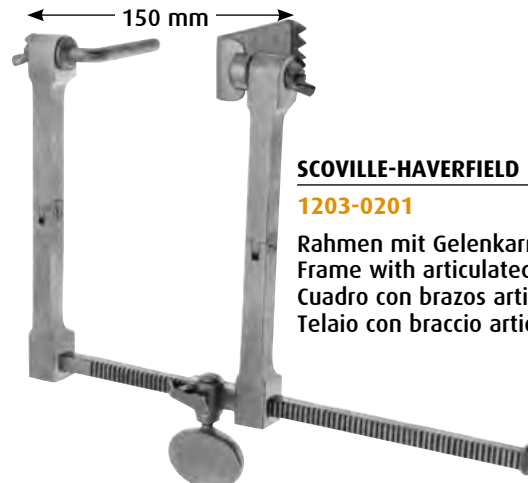
SCOVILLE**1203-0300****SCOVILLE-HAVERFIELD****1203-0201**

Rahmen mit Gelenkarmen, allein
 Frame with articulated arms, only
 Cuadro con brazos articulados, suelto
 Telaio con braccio articolato, solo

SCOVILLE-HAVERFIELD**1203-0200**

Wundspreizer, komplett, bestehend aus:

- 1 Rahmen (1203-0301)
- 1 Haken 50 mm (1203-0302)
- 1 Seitenvalve 63 x 25 mm (a x b) (1203-0306)

Self-retaining retractor, complete, consisting of:

- 1 Frame (1203-0301)
- 1 Hook 50 mm (1203-0302)
- 1 Lateral valve 63 x 25 mm (a x b) (1203-0306)

Separador, completo, compuesto de:

- 1 Cuadro (1203-0301)
- 1 Gancho 50 mm (1203-0302)
- 1 Valva lateral 63 x 25 mm (a x b) (1203-0306)

Divaricatore, completo, composto da:

- 1 Telaio (1203-0301)
- 1 Divaricatore 50 mm (1203-0302)
- 1 Valva laterale 63 x 25 mm (a x b) (1203-0306)

Wundspreizer, komplett, bestehend aus:

- 1 Rahmen (1203-0201)
- 1 Haken 50 mm (1203-0202)
- 1 Seitenvalve 63 x 25 mm (a x b) (1203-0203)

Self-retaining retractor, complete, consisting of:

- 1 Frame (1203-0201)
- 1 Hook 50 mm (1203-0202)
- 1 Lateral valve 63 x 25 mm (a x b) (1203-0203)

Separador, completo, compuesto de:

- 1 Cuadro (1203-0201)
- 1 Gancho 50 mm (1203-0202)
- 1 Valva lateral 63 x 25 mm (a x b) (1203-0203)

Divaricatore, completo, composto da:

- 1 Telaio (1203-0201)
- 1 Divaricatore 50 mm (1203-0202)
- 1 Valva laterale 63 x 25 mm (a x b) (1203-0203)



SCOVILLE

- 1203-0304** 50,0 mm
- 1203-0303** 75,0 mm

Haken für Wundspreizer
 (1303-0301 und 1303-0302)
 Hooks for self-retaining retractors
 (1303-0301 und 1303-0302)
 Ganchos para separadores
 (1303-0301 und 1303-0302)
 Gancio per divaricatori
 (1303-0301 und 1303-0302)

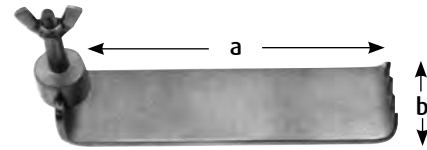

SCOVILLE

- 1203-0306** 63 x 25 mm (a x b)
- 1203-0307** 64 x 50 mm (a x b)
- 1203-0308** 88 x 25 mm (a x b)

Seitenvalven für Wundspreizer
 (1303-0301 und 1303-0302)
 Lateral valves for self-retaining
 (1303-0301 und 1303-0302)
 Valvas laterales para separadores
 (1303-0301 und 1303-0302)
 Valve laterali per divaricatori
 (1303-0301 und 1303-0302)

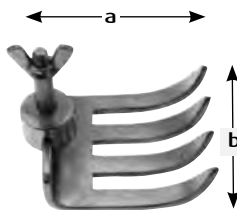

SCOVILLE

- 1203-0315** 41 x 38 mm (a x b)
- 1203-0316** 67 x 44 mm (a x b)

Seitenvalven für Wundspreizer
 (1303-0301 und 1303-0302)
 Lateral valves for self-retaining
 (1303-0301 und 1303-0302)
 Valvas laterales para separadores
 (1303-0301 und 1303-0302)
 Valve laterali per divaricatori
 (1303-0301 und 1303-0302)

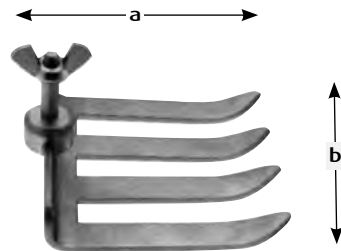

TAYLOR

- 1203-0311** 48 x 50 mm (a x b)
- 1203-0312** 64 x 64 mm (a x b)
- 1203-0313** 80 x 57 mm (a x b)

Seitenvalven für Wundspreizer
 (1303-0301 und 1303-0302)
 Lateral valves for self-retaining
 (1303-0301 und 1303-0302)
 Valvas laterales para separadores
 (1303-0301 und 1303-0302)
 Valve laterali per divaricatori
 (1303-0301 und 1303-0302)

Wundspreizer, Seitenvalven 52 x 44 mm (a x b)
Self-retaining retractor, lateral valves 52 x 44 mm (a x b)
Separador, valvas laterales 52 x 44 mm (a x b)
Divaricatore, Valve laterali 52 x 44 mm (a x b)

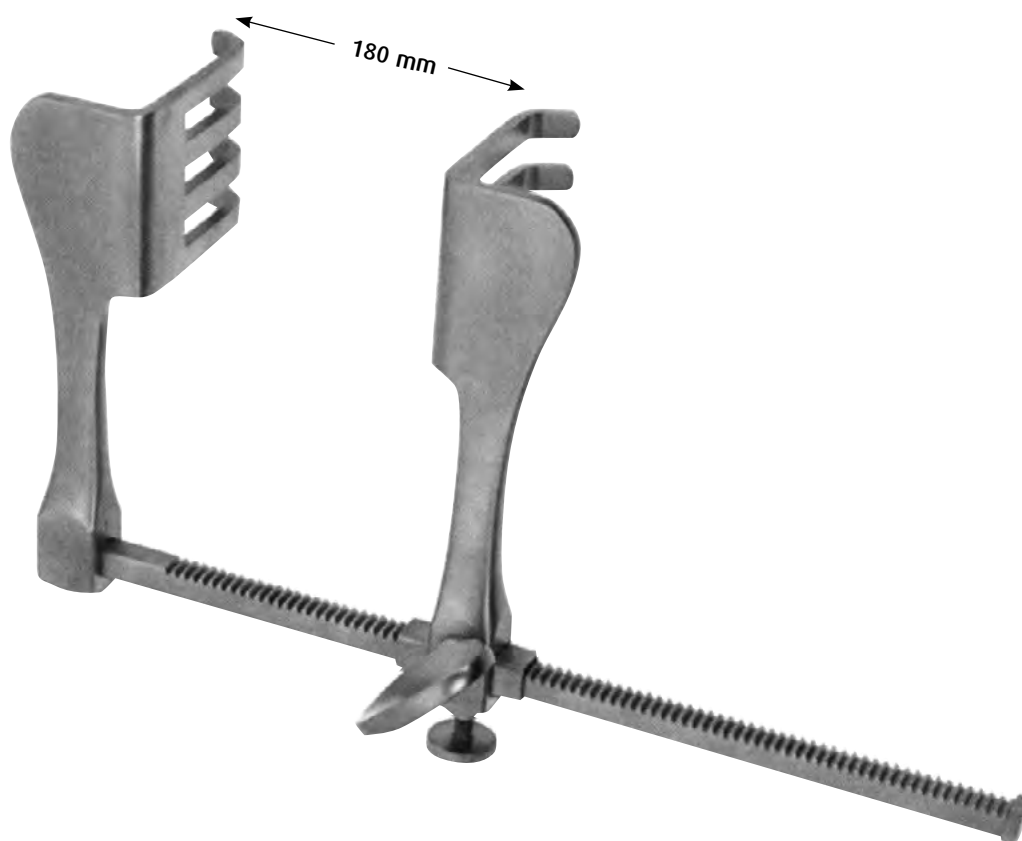

BADGLEY
1203-4918

Laminektomie-Spreizer
Laminectomy Retractors
Separadores para laminectomía
Divaricatori per laminectomia

Lumbal, thorakal und cervical einzusetzen!
 For use of lumbar, thoracic and cervical!
 Útil para lumbar, toracal y cervical!
 Per impiego lombare, toracico e cervicale



CASPAR

1203-5000

Wundspreizer mit Gelenkarmen und Kugelschnellverschluss, für Laminektomie und Hemi-Laminektomie, komplett, bestehend aus:
 1 Rahmen (1203-5001)
 1 Drehschlüssel (1203-5002)
 1 Haken 38 mm (1203-5113)
 1 Seitenvalve 37 x 22 mm (1203-5237)
 1 Seitenvalve 43 x 22 mm (1203-5243)
 1 Seitenvalve 47 x 22 mm (1203-5247)
 1 Seitenvalve 52 x 22 mm (1203-5252)
 1 Seitenvalve 57 x 22 mm (1203-5257)

Separador con brazos articulados y cierre rápido esférico, para laminectomía y hemilaminectomía, completo, compuesto de:
 1 Cuadro (1203-5001)
 1 Llave (1203-5002)
 1 Gancho 38 mm (1203-5113)
 1 Valva lateral 37 x 22 mm (1203-5237)
 1 Valva lateral 43 x 22 mm (1203-5243)
 1 Valva lateral 47 x 22 mm (1203-5247)
 1 Valva lateral 52 x 22 mm (1203-5252)
 1 Valva lateral 57 x 22 mm (1203-5257)

1203-5001

Rahmen mit Gelenkarmen, allein
 Frame with articulated arms, only
 Cuadro con brazos articulados, suelto
 Telaio con braccio articolato, solo

Self-retaining retractor with articulated arms and ball snap closure, for laminectomy and hemi-laminectomy, complete, consisting of:
 1 Frame (1203-5001)
 1 Key (1203-5002)
 1 Hook 38 mm (1203-5113)
 1 Lateral valve 37 x 22 mm (1203-5237)
 1 Lateral valve 43 x 22 mm (1203-5243)
 1 Lateral valve 47 x 22 mm (1203-5247)
 1 Lateral valve 52 x 22 mm (1203-5252)
 1 Lateral valve 57 x 22 mm (1203-5257)

Divaricatore con braccio articolato a chiusura istantanea, per laminectomia e emilaminectomia, completo, composto da:
 1 Telaio (1203-5001)
 1 Chiave (1203-5002)
 1 Gancio 38 mm (1203-5113)
 1 Valva laterale 37 x 22 mm (1203-5237)
 1 Valva laterale 43 x 22 mm (1203-5243)
 1 Valva laterale 47 x 22 mm (1203-5247)
 1 Valva laterale 52 x 22 mm (1203-5252)
 1 Valva laterale 57 x 22 mm (1203-5257)



1203-5002
 Drehschlüssel
 Key
 Llave
 chiave



1203-5113 38,0 mm



1203-5237 37 x 22 mm (a x b)

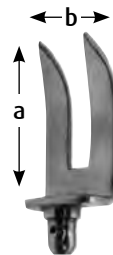

1203-5243 43 x 22 mm (a x b)



1203-5247 47 x 22 mm (a x b)



1203-5252 52 x 22 mm (a x b)



1203-5257 57 x 22 mm (a x b)



1203-5113 38,0 mm
1203-5115 58,0 mm

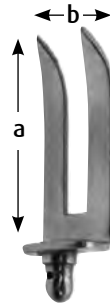

1203-5232 32 mm x 22 mm (a x b)
1203-5237 37 mm x 22 mm (a x b)
1203-5243 43 mm x 22 mm (a x b)
1203-5247 47 mm x 22 mm (a x b)
1203-5252 52 mm x 22 mm (a x b)
1203-5257 57 mm x 22 mm (a x b)
1203-5262 62 mm x 22 mm (a x b)
1203-5267 67 mm x 22 mm (a x b)



1203-5332 32 mm x 37 mm (a x b)
1203-5337 37 mm x 37 mm (a x b)
1203-5343 43 mm x 37 mm (a x b)
1203-5347 47 mm x 37 mm (a x b)
1203-5352 52 mm x 37 mm (a x b)
1203-5357 57 mm x 37 mm (a x b)
1203-5362 62 mm x 37 mm (a x b)
1203-5367 67 mm x 37 mm (a x b)



1203-5432 32 mm x 52 mm (a x b)
1203-5437 37 mm x 52 mm (a x b)
1203-5443 43 mm x 52 mm (a x b)
1203-5447 47 mm x 52 mm (a x b)
1203-5452 52 mm x 52 mm (a x b)
1203-5457 57 mm x 52 mm (a x b)
1203-5462 62 mm x 52 mm (a x b)
1203-5467 67 mm x 52 mm (a x b)



1203-5899 11,5 cm / 4¹/₂"

Pinzette zum Valvenwechsel bei Kugelschnellverschluß-System

Valve ejector for changing the valves with ball snap closure system

Pinza para el cambio de valvas con el sistema de cierre rapido esférico

Pinza per il cambio delle valve a chiusura istantanea

Laminektomie-Spreizer, Valven
Laminectomy Retractors, Valves
Separadores para laminectomia, Valvas
Divaricatori per laminectomia, Valve

CASPAR

1203-5500



Wundspreizer mit Gelenkarmen und Kugelschnellverschluß, komplett, bestehend aus:
 1 Rahmen (1203-5501)
 1 medialen Valve 40 x 23 mm (1203-5801)
 1 medialen Valve 45 x 23 mm (1203-5802)
 1 medialen Valve 50 x 23 mm (1203-5803)
 1 medialen Valve 55 x 23 mm (1203-5804)
 1 medialen Valve 60 x 23 mm (1203-5805)
 1 lateralen Valve 40 x 23 mm (1203-5811)
 1 lateralen Valve 45 x 23 mm (1203-5812)
 1 lateralen Valve 50 x 23 mm (1203-5813)
 1 lateralen Valve 55 x 23 mm (1203-5814)
 1 lateralen Valve 60 x 23 mm (1203-5815)

Self-retaining retractor with articulated arms and ball snap closure, complete, consisting of:
 1 Frame (1203-5501)
 1 Medial valve 40 x 23 mm (1203-5801)
 1 Medial valve 45 x 23 mm (1203-5802)
 1 Medial valve 50 x 23 mm (1203-5803)
 1 Medial valve 55 x 23 mm (1203-5804)
 1 Medial valve 60 x 23 mm (1203-5805)
 1 Lateral valve 40 x 23 mm (1203-5811)
 1 Lateral valve 45 x 23 mm (1203-5812)
 1 Lateral valve 50 x 23 mm (1203-5813)
 1 Lateral valve 55 x 23 mm (1203-5814)
 1 Lateral valve 60 x 23 mm (1203-5815)

Separador con brazos articulados y cierre rápido esférico, completo, compuesto de:
 1 Cuadro (1203-5501)
 1 Valva mediana 40 x 23 mm (1203-5801)
 1 Valva mediana 45 x 23 mm (1203-5802)
 1 Valva mediana 50 x 23 mm (1203-5803)
 1 Valva mediana 55 x 23 mm (1203-5804)
 1 Valva mediana 60 x 23 mm (1203-5805)
 1 Valva lateral 40 x 23 mm (1203-5811)
 1 Valva lateral 45 x 23 mm (1203-5812)
 1 Valva lateral 50 x 23 mm (1203-5813)
 1 Valva lateral 55 x 23 mm (1203-5814)
 1 Valva lateral 60 x 23 mm (1203-5815)

Divaricatore con braccio articolato a chiusura istantanea, completo, composto da:
 1 Telaio (1203-5501)
 1 Valva media 40 x 23 mm (1203-5801)
 1 Valva media 45 x 23 mm (1203-5802)
 1 Valva media 50 x 23 mm (1203-5803)
 1 Valva media 55 x 23 mm (1203-5804)
 1 Valva media 60 x 23 mm (1203-5805)
 1 Valva laterale 40 x 23 mm (1203-5811)
 1 Valva laterale 45 x 23 mm (1203-5812)
 1 Valva laterale 50 x 23 mm (1203-5813)
 1 Valva laterale 55 x 23 mm (1203-5814)
 1 Valva laterale 60 x 23 mm (1203-5815)

1203-5501

Rahmen mit Gelenkarmen, allein
 Frame with articulated arms, only
 Cuadro con brazos articulados, solo
 Telaio con braccio articolato, solo

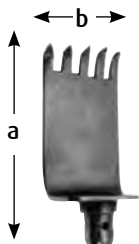

1203-5801
40 x 23 mm (a x b)



1203-5802
45 x 23 mm (a x b)



1203-5803
50 x 23 mm (a x b)



1203-5804
55 x 23 mm (a x b)



1203-5805
60 x 23 mm (a x b)



1203-5811
40 x 23 mm (a x b)



1203-5812
45 x 23 mm (a x b)



1203-5813
50 x 23 mm (a x b)



1203-5814
55 x 23 mm (a x b)



1203-5815
60 x 23 mm (a x b)

← 85 mm →



1203-5601

Sperrer allein
 Spreader only
 Seperador suelto
 Divaricatore solo

CASPAR

1203-5600 10,5 cm / 4¹/₄"

Wundspreizer mit Gelenkarmen und Kugelschnellverschluß-komplett, bestehend aus:

- 1 Sperrer (1203-5601)
- 1 stumpfe Valve 45 x 23 mm (1203-5821)
- 1 stumpfe Valve 50 x 23 mm (1203-5822)
- 1 stumpfe Valve 55 x 23 mm (1203-5823)
- 1 stumpfe Valve 60 x 23 mm (1203-5824)
- 1 stumpfe Valve 65 x 23 mm (1203-5825)

Self-retaining retractor with articulated arms and ball snap closure, complete, consisting of:

- 1 Spreader (1203-5601)
- 1 Blunt valve 45 x 23 mm (1203-5821)
- 1 Blunt valve 50 x 23 mm (1203-5822)
- 1 Blunt valve 55 x 23 mm (1203-5823)
- 1 Blunt valve 60 x 23 mm (1203-5824)
- 1 Blunt valve 65 x 23 mm (1203-5825)

Seperador con brazos articulados y cierre rápido esférico, completo compuesto de:

- 1 Separador (1203-5601)
- 1 Valva roma 45 x 23 mm (1203-5821)
- 1 Valva roma 50 x 23 mm (1203-5822)
- 1 Valva roma 55 x 23 mm (1203-5823)
- 1 Valva roma 60 x 23 mm (1203-5824)
- 1 Valva roma 65 x 23 mm (1203-5825)

Divaricatore con braccio articolato a chiusura istantanea, completo, composto da:

- 1 Divaricatore (1203-5601)
- 1 Valva smussa 45 x 23 mm (1203-5821)
- 1 Valva smussa 50 x 23 mm (1203-5822)
- 1 Valva smussa 55 x 23 mm (1203-5823)
- 1 Valva smussa 60 x 23 mm (1203-5824)
- 1 Valva smussa 65 x 23 mm (1203-5825)

In Wirbelsäulen-Längsachse zu verwenden!

To be used for up and down retraction!

Útil para el eje longitudinal de la columna vertebra!

Da impiegarsi per la trazione e la compressione della colonna!

← 90 mm →



1203-5701

Sperrer allein
 Spreader only
 Seperador suelto
 Divaricatore solo

CASPAR

1203-5700 16,5 cm / 6¹/₂"

Wundspreizer mit Gelenkarmen und Kugelschnellverschluß-komplett, bestehend aus:

- 1 Sperrer (1203-5701)
- 1 stumpfe Valve 45 x 23 mm (1203-5821)
- 1 stumpfe Valve 50 x 23 mm (1203-5822)
- 1 stumpfe Valve 55 x 23 mm (1203-5823)
- 1 stumpfe Valve 60 x 23 mm (1203-5824)
- 1 stumpfe Valve 65 x 23 mm (1203-5825)

Self-retaining retractor with articulated arms and ball snap closure, complete, consisting of:

- 1 Spreader (1203-5701)
- 1 Blunt valve 45 x 23 mm (1203-5821)
- 1 Blunt valve 50 x 23 mm (1203-5822)
- 1 Blunt valve 55 x 23 mm (1203-5823)
- 1 Blunt valve 60 x 23 mm (1203-5824)
- 1 Blunt valve 65 x 23 mm (1203-5825)

Seperador con brazos articulados y cierre rápido esférico, completo compuesto de:

- 1 Separador (1203-5701)
- 1 Valva roma 45 x 23 mm (1203-5821)
- 1 Valva roma 50 x 23 mm (1203-5822)
- 1 Valva roma 55 x 23 mm (1203-5823)
- 1 Valva roma 60 x 23 mm (1203-5824)
- 1 Valva roma 65 x 23 mm (1203-5825)

Divaricatore con braccio articolato a chiusura istantanea, completo, composto da:

- 1 Divaricatore (1203-5701)
- 1 Valva smussa 45 x 23 mm (1203-5821)
- 1 Valva smussa 50 x 23 mm (1203-5822)
- 1 Valva smussa 55 x 23 mm (1203-5823)
- 1 Valva smussa 60 x 23 mm (1203-5824)
- 1 Valva smussa 65 x 23 mm (1203-5825)

Valven, stumpf
Valves, blunt
Valvas, romas
Valve, smusso

026

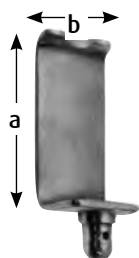

1203-5821
45 x 23 mm (a x b)



1203-5822
50 x 23 mm (a x b)



1203-5823
55 x 23 mm (a x b)



1203-5824
60 x 23 mm (a x b)



1203-5825
65 x 23 mm (a x b)



1203-5831
50 x 25 mm (a x b)



1203-5832
60 x 25 mm (a x b)

Oberfläche geschwärzt
 Surface black-finish
 Superficie negra
 Superficie nera



1203-6701

Rahmen mit Gelenkarmen, allein
 Frame with articulated arms, only
 Cuadro con brazos articulados, suelto
 Relais con braccio articolato, solo

CASPAR

1203-6700

Wundspreizer mit Gelenkarmen und
 Kugelschnellverschluß-komplett, bestehend aus:

- 1 Rahmen (1203-6701)
- 1 Seitenvalve 35 x 12 mm (1203-6702)
- 1 Seitenvalve 40 x 13 mm (1203-6703)
- 1 Seitenvalve 45 x 13 mm (1203-6704)
- 1 Seitenvalve 50 x 14 mm (1203-6705)
- 1 Seitenvalve 55 x 14 mm (1203-6706)
- 1 Seitenvalve 60 x 15 mm (1203-6707)

Seperador con brazos articulados y cierre
 rápido esférico, completo compuesto de:

- 1 Cuadro (1203-6701)
- 1 Valva lateral 35 x 12 mm (1203-6702)
- 1 Valva lateral 40 x 13 mm (1203-6703)
- 1 Valva lateral 45 x 13 mm (1203-6704)
- 1 Valva lateral 50 x 14 mm (1203-6705)
- 1 Valva lateral 55 x 14 mm (1203-6706)
- 1 Valva lateral 60 x 15 mm (1203-6707)

Self-retaining retractor with articulated arms and
 ball snap closure, complete, consisting of:

- 1 Frame (1203-6701)
- 1 Lateral valve 35 x 12 mm (1203-6702)
- 1 Lateral valve 40 x 13 mm (1203-6703)
- 1 Lateral valve 45 x 13 mm (1203-6704)
- 1 Lateral valve 50 x 14 mm (1203-6705)
- 1 Lateral valve 55 x 14 mm (1203-6706)

Divaricatore con braccio articolato a chiusura
 istantanea, completo, composto da:

- 1 Telaio (1203-6701)
- 1 Valva laterale 35 x 12 mm (1203-6702)
- 1 Valva laterale 40 x 13 mm (1203-6703)
- 1 Valva laterale 45 x 13 mm (1203-6704)
- 1 Valva laterale 50 x 14 mm (1203-6705)
- 1 Valva laterale 55 x 14 mm (1203-6706)



1203-6702

35 x 12 mm (a x b)

1203-6703

40 x 13 mm (a x b)

1203-6704

45 x 13 mm (a x b)

1203-6705

50 x 14 mm (a x b)

1203-6706

55 x 14 mm (a x b)

1203-6707

60 x 15 mm (a x b)

Spekula für lumbale Bandscheibenoperationen
Specula for lumbar vertebral operations
Espéculos para la cirugía lumbar vertebral
Speculi per chirurgia lombo vertebrale



Oberfläche geschwärzt
 Surface black-finish
 Superficie negra
 Superficie nera

CASPAR

1203-6640 - 1203-6660

15,0 cm / 6"

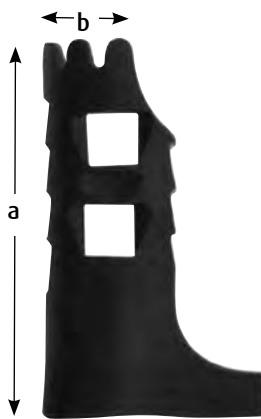

1203-6640
 40 x 18 mm (a x b)



1203-6645
 45 x 18 mm (a x b)



1203-6650
 50 x 18 mm (a x b)



1203-6655
 55 x 18 mm (a x b)



1203-6660
 60 x 18 mm (a x b)

Spreizweite 18 mm
 Blade opening 18 mm
 Abertura de la hoja 18 mm
 Apertura lame 18 mm



CLOWARD

1203-7113 13,0 cm / 5¹/₈"

Spreizweite 18 mm
 Blade opening 18 mm
 Abertura de la hoja 18 mm
 Apertura lame 18 mm



CLOWARD

1203-7115 16,0 cm / 6¹/₄"

Spreizweite 38 mm
 Blade opening 38 mm
 Abertura de la hoja 38 mm
 Apertura lame 38 mm



INGE

1203-7502 16,0 cm / 6¹/₄"



INGE

1203-7627 27,0 cm / 10¹/₂"

Laminektomie-Stanzen
 Laminectomy Punches
 Pinzas cortantes para laminectomía
 Pinze per laminectomia

nicht zerlegbar
 non detachable
 non desmontabile
 non smontabile

026

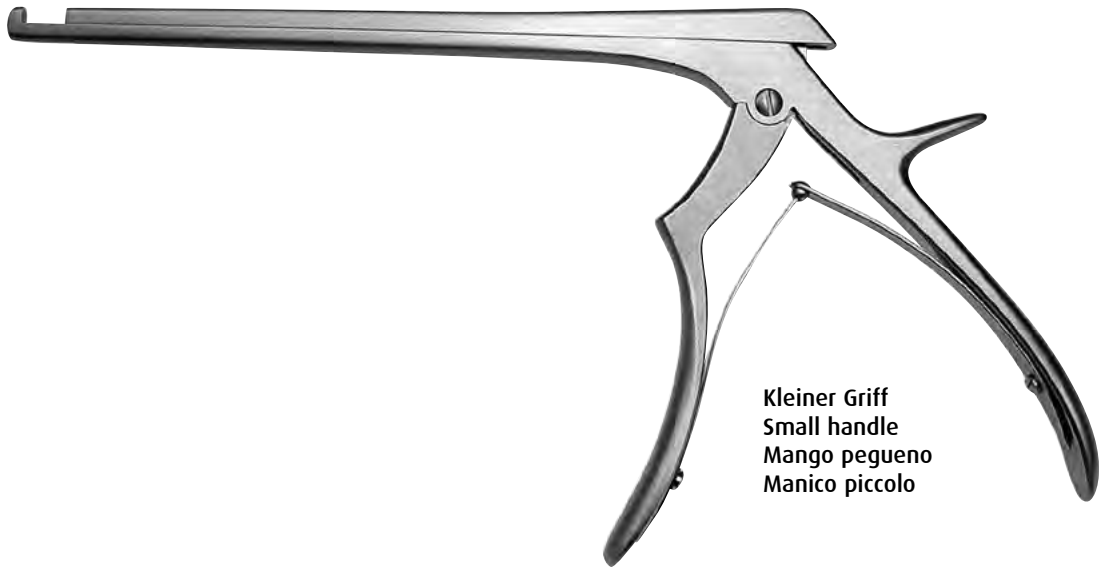

Kleiner Griff
 Small handle
 Mango pequeño
 Manico piccolo

KERRISON

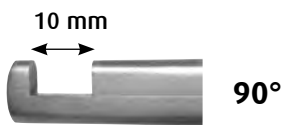

Schaftlänge Length of shaft Longitud del vástago Lunghezza dell'asta	Bissbreite / Width of bite / Anchura de la boca / Larghezza del morso					
	1 mm	2 mm	3 mm	4 mm	5 mm	6 mm
180 mm	1400-1001	1400-1002 E	1400-1003 E	1400-1004 E	1400-1005 E	1400-1006 E
200 mm	1400-1011	1400-1012 E	1400-1013 E	1400-1014 E	1400-1015 E	1400-1016 E
230 mm		1400-1022 E	1400-1023 E	1400-1024 E	1400-1025 E	-

Dünnfuß (Mikro)
Thin footplate (Micro)
Lámin de punzonar estrecha (Micro)
Battente sottile (Micro)

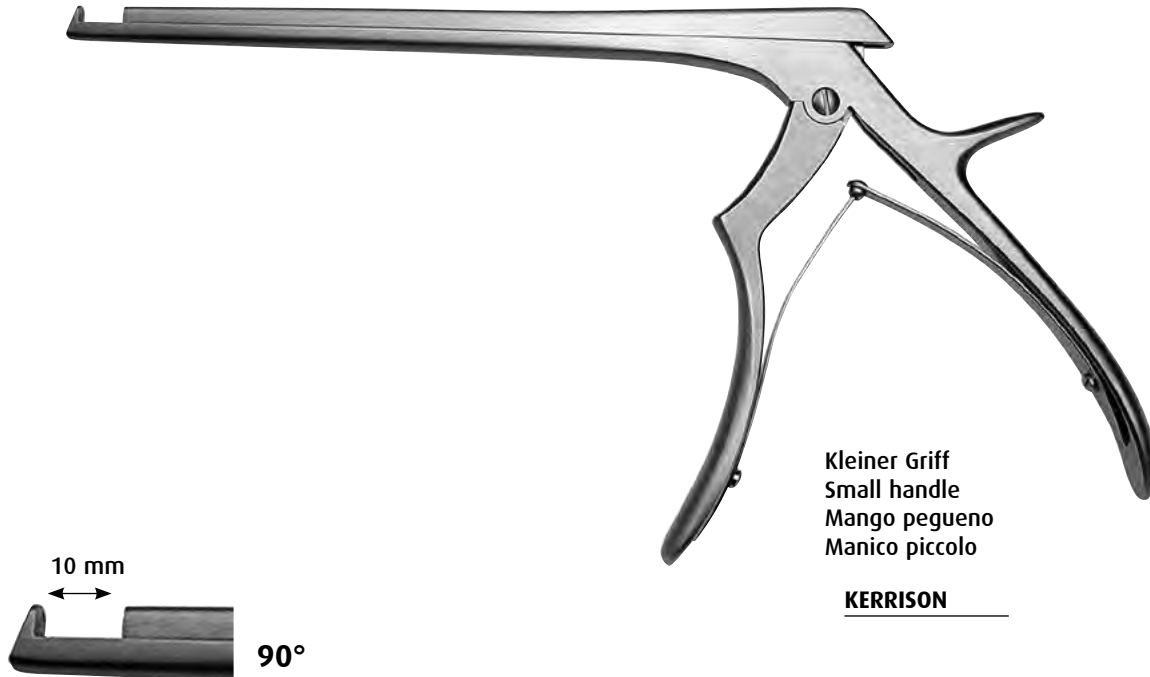

Schaftlänge Length of shaft Longitud del vástago Lunghezza dell'asta	Bissbreite / Width of bite / Anchura de la boca / Larghezza del morso				
	2 mm	3 mm	4 mm	5 mm	6 mm
180 mm	1400-1002 FE	1400-1003 FE	1400-1004 FE	1400-1005 FE	1400-1006 FE
200 mm	1400-1012 FE	1400-1013 FE	1400-1014 FE	1400-1015 FE	1400-1016 FE
230 mm	1400-1022 FE	1400-1023 FE	1400-1024 FE	1400-1025 FE	-

Laminektomie-Stanzen
 Laminectomy Punches
 Pinzas cortantes para laminectomía
 Pinze per laminectomia

nicht zerlegbar
 non detachable
 non desmontable
 non smontabile

026

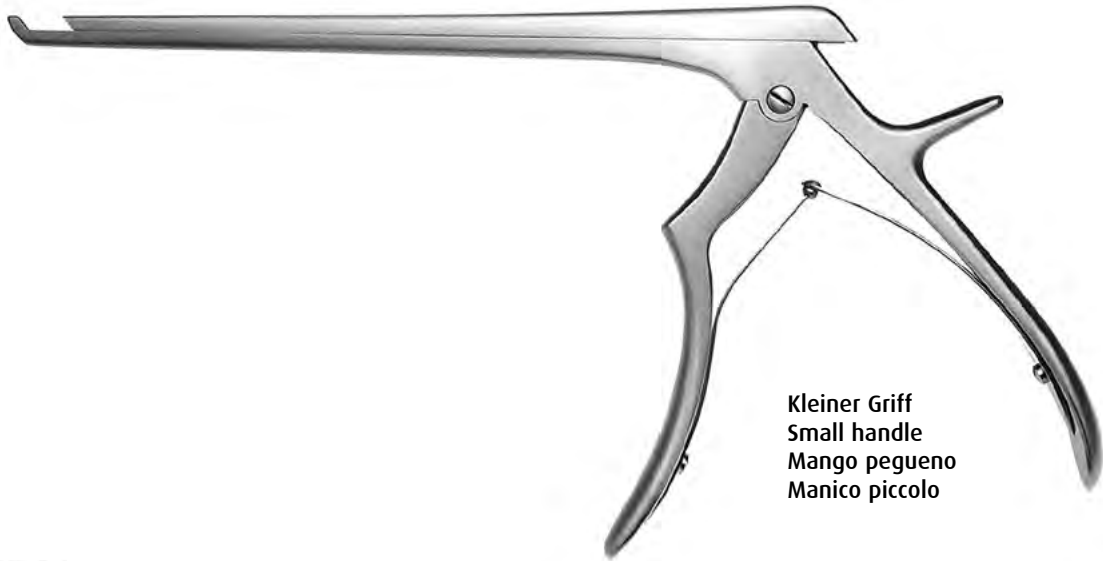

Kleiner Griff
 Small handle
 Mango pegueno
 Manico piccolo

KERRISON

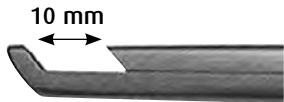

130° (40°)

Schaftlänge Length of shaft Longitud del vástago Lunghezza dell'asta	Bissbreite / Width of bite / Anchura de la boca / Larghezza del morso					
	1 mm	2 mm	3 mm	4 mm	5 mm	6 mm
180 mm	1400-1101	1400-1102	1400-1103	1400-1104	1400-1105	1400-1106
200 mm	1400-1111	1400-1112	1400-1113	1400-1114	1400-1115	1400-1116
230 mm	-	1400-1122	1400-1123	1400-1124	1400-1125	-

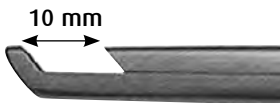

130° (40°)

mit Auswerfer
 with ejector
 con espulsor
 con espulsore

Schaftlänge Length of shaft Longitud del vástago Lunghezza dell'asta	Bissbreite / Width of bite / Anchura de la boca / Larghezza del morso		
	3 mm	4 mm	5 mm
180 mm	1400-1103 E	1400-1104 E	1400-1105 E
200 mm	1400-1113 E	1400-1114 E	1400-1115 E

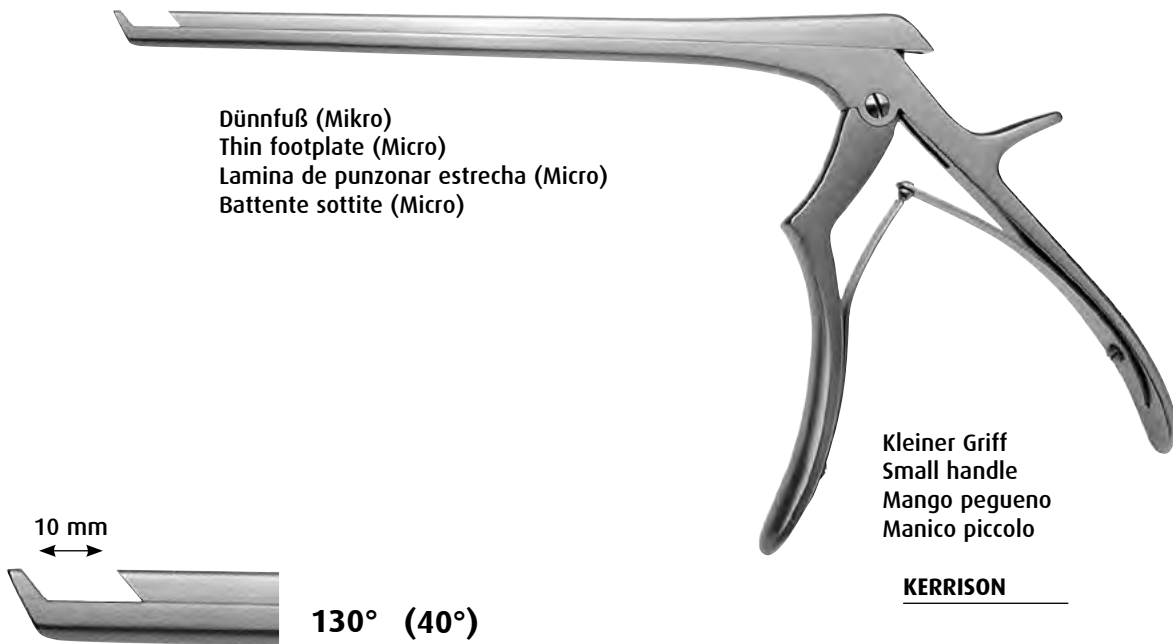

Schaftlänge Length of shaft Longitud del vástago Lunghezza dell'asta	Bissbreite / Width of bite / Anchura de la boca / Larghezza del morso				
	2 mm	3 mm	4 mm	5 mm	6 mm
180 mm	1400-1102 F	1400-1103 F	1400-1104 F	1400-1105 F	1400-1106 F
200 mm	1400-1112 F	1400-1113 F	1400-1114 F	1400-1115 F	1400-1116 F
230 mm	1400-1122 F	1400-1123 F	1400-1124 F	1400-1125 F	-



Schaftlänge Length of shaft Longitud del vástago Lunghezza dell'asta	Bissbreite / Width of bite / Anchura de la boca / Larghezza del morso		
	3 mm	4 mm	5 mm
180 mm	1400-1103 FE	1400-1104 FE	1400-1105 FE
200 mm	1400-1113 FE	1400-1114 FE	1400-1115 FE

Laminektomie-Stanzen
Laminectomy Punches
Pinzas cortantes para laminectomía
Pinze per laminectomia

nicht zerlegbar
non detachable
non desmontable
non smontabile

026



Kleiner Griff
Small handle
Mango pequeño
Manico piccolo

KERRISON



Standardfuß
Standard footplate
Lámin de punzonar standard
Battente standard

Schaftlänge Length of shaft Longitud del vástago Lunghezza dell'asta	Bissbreite / Width of bite / Anchura de la boca / Larghezza del morso			
	2 mm	3 mm	4 mm	5 mm
180 mm	1400-1202	1400-1203	1400-1204	1400-1205
200 mm	1400-1212	1400-1213	1400-1214	1400-1215



Dünnfuß (Mikro)
Thin footplate (Micro)
Lámina de punzonar estrecha (Micro)
Battente sottile

Schaftlänge Length of shaft Longitud del vástago Lunghezza dell'asta	Bissbreite / Width of bite / Anchura de la boca / Larghezza del morso			
	2 mm	3 mm	4 mm	5 mm
180 mm	1400-1202 F	1400-1203 F	1400-1204 F	1400-1205 F
200 mm	1400-1212 F	1400-1213 F	1400-1214 F	1400-1215 F

026

Laminektomie-Stanzen
Laminectomy Punches
Pinzas cortantes para laminectomía
Pinze per laminectomia

nicht zerlegbar
non detachable
non smontabile

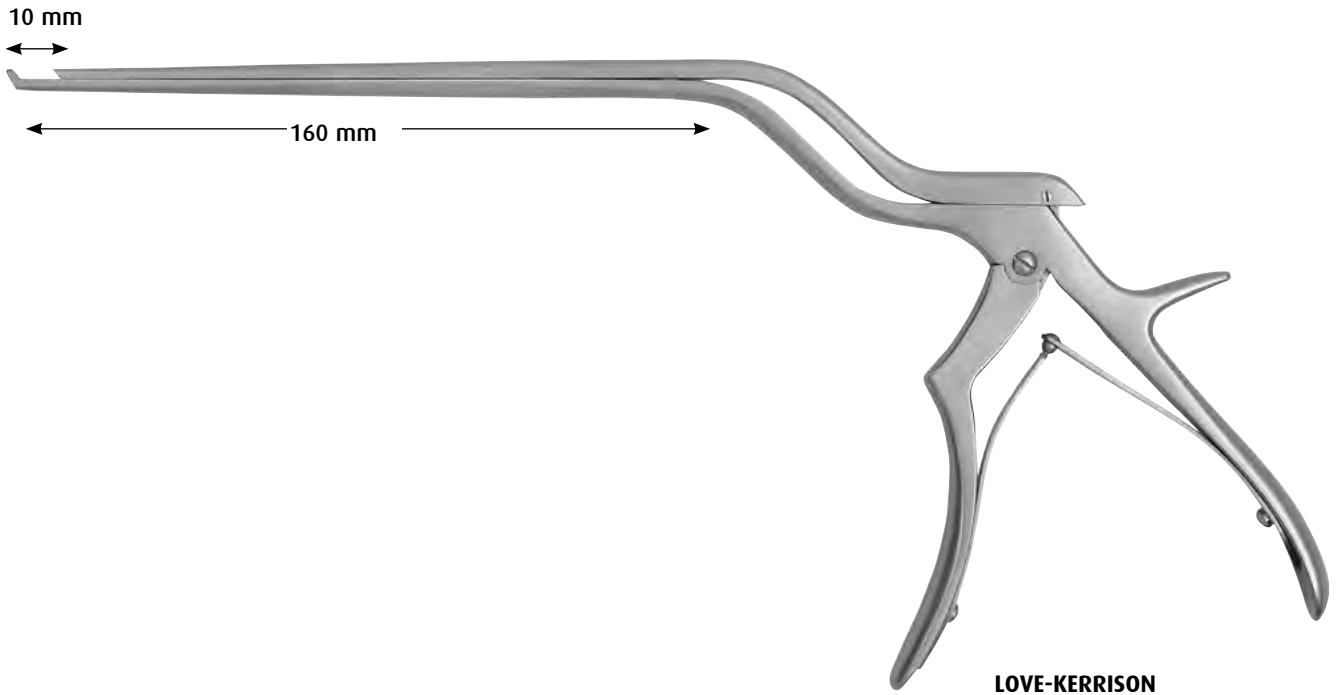

Standardfuß
Standard footplate
Lámin de punzonar standard
Battente standard

Schaftlänge Length of shaft Longitud del vástago Lunghezza dell'asta	Bissbreite / Width of bite / Anchura de la boca / Larghezza del morso			
	2 mm	3 mm	4 mm	5 mm
160 mm	1400-1302	1400-1303	1400-1304	1400-1305



Dünfuß (Mikro)
Thin footplate (Micro)
Lámina de punzonar estrecha (Micro)
Battente sottile

Schaftlänge Length of shaft Longitud del vástago Lunghezza dell'asta	Bissbreite / Width of bite / Anchura de la boca / Larghezza del morso			
	2 mm	3 mm	4 mm	5 mm
160 mm	1400-1302 F	1400-1303 F	1400-1304 F	1400-1305 F

Laminektomie-Stanzen
 Laminectomy Punches
 Pinzas cortantes para laminectomía
 Pinze per laminectomia

nicht zerlegbar
 non detachable
 non desmontabile
 non smontabile

026

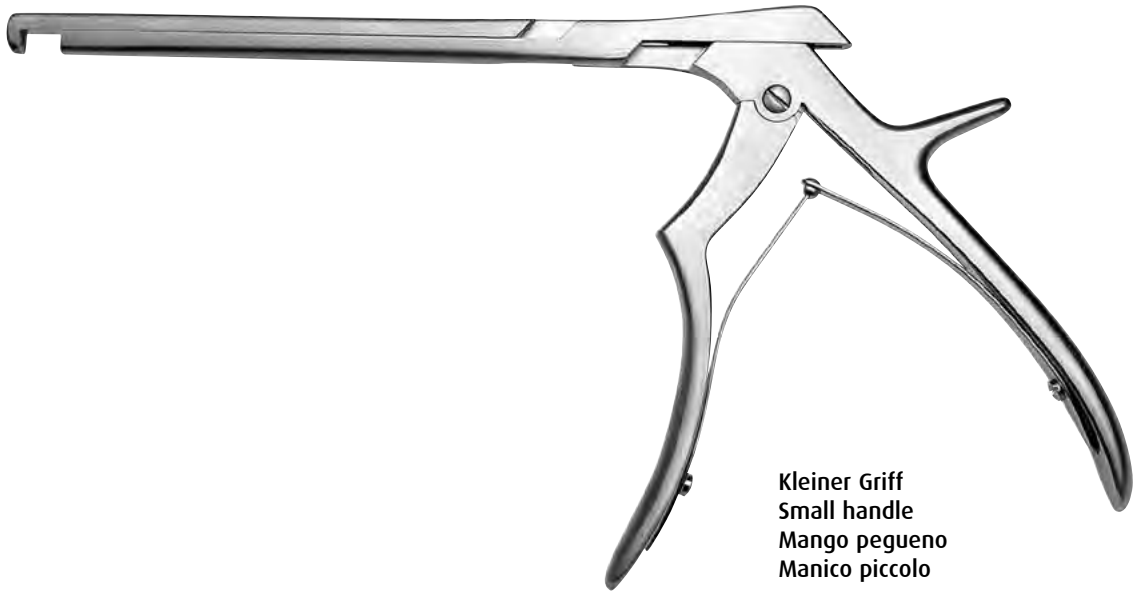

Kleiner Griff
 Small handle
 Mango pegueno
 Manico piccolo

KERRISON



Schaftlänge Length of shaft Longitud del vástago Lunghezza dell'asta	Bissbreite / Width of bite / Anchura de la boca / Larghezza del morso				
	2 mm	3 mm	4 mm	5 mm	6 mm
180 mm	1401-1002	1401-1003	1401-1004	1401-1005	1401-1006
200 mm	1401-1012	1401-1013	1401-1014	1401-1015	1401-1016

026

Laminektomie-Stanzen
Laminectomy Punches
Pinzas cortantes para laminectomía
Pinze per laminectomia

nicht zerlegbar
non detachable
non desmontable
non smontabile

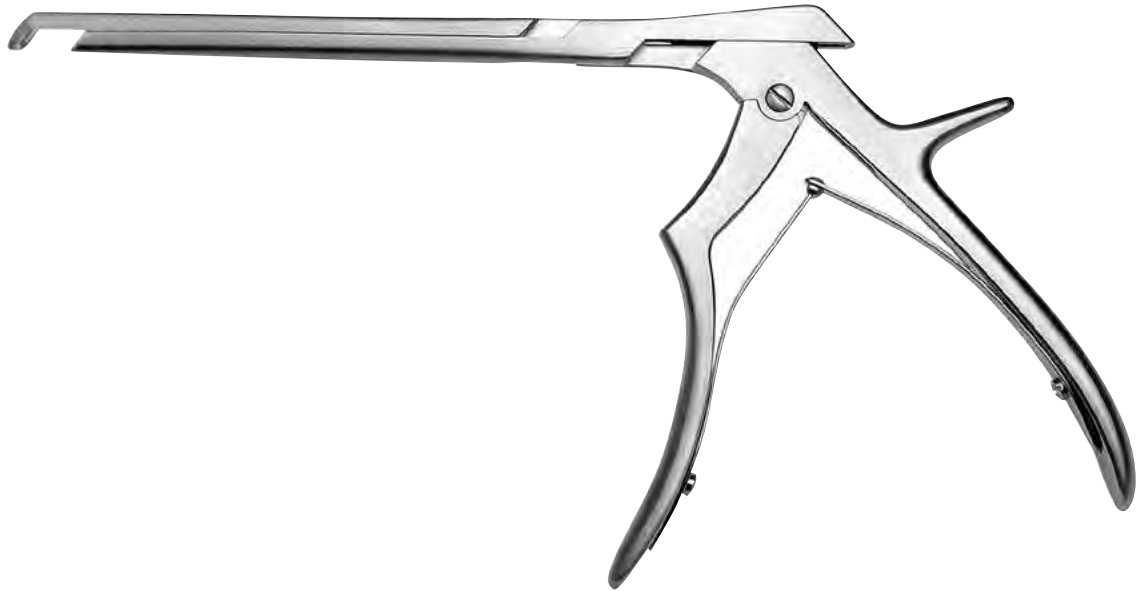

KERRISON

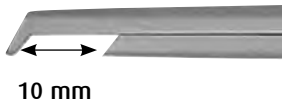

10 mm

130° (40°)

Schaftlänge Length of shaft Longitud del vástago Lunghezza dell'asta	Bissbreite / Width of bite / Anchura de la boca / Larghezza del morso			
	2 mm	3 mm	4 mm	5 mm
180 mm	1401-1102	1401-1103	1401-1104	1401-1105

- ein Teil
- einfach zu demontieren
- einfach zu reinigen
- einfach zusammenzufügen

Demontage Disassembly



Zuerst den Griff schließen ...
First close the handle ...



dann den Riegel nach unten drücken ...
than push the lever downwards ...



nun den Griff wieder öffnen ...
now open the handle ...

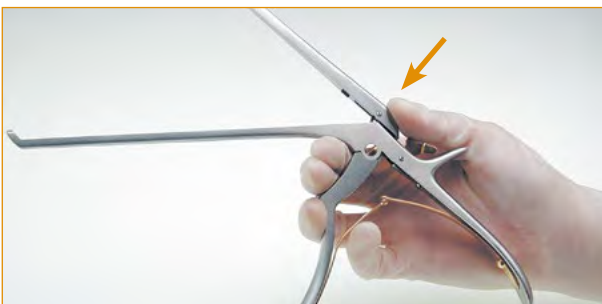

und hinten auf den Schaft drücken.
and push downwards at the end of shaft.

- one piece
- easy to disassemble
- easy to clean
- easy to assemble

Zusammenfügen Assembly



Zuerst Schaftteile ineinandersetzen ...
First push shaft parts into one other ...



dann den Griff schließen ...
than close the handle ...

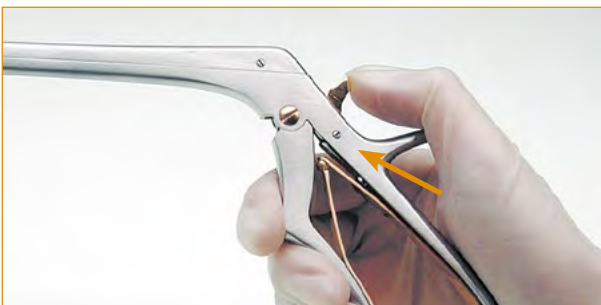

nun den Riegel nach oben drücken ...
now push the lever upwards ...



und den Griff wieder öffnen.
and finally open the handle.

Laminektomie-Stanzen
 Laminectomy Punches
 Pinzas cortantes para laminectomía
 Pinze per laminectomia

zerlegbar
 detachable
 desmontable
 smontabile

026

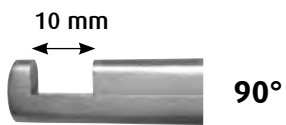
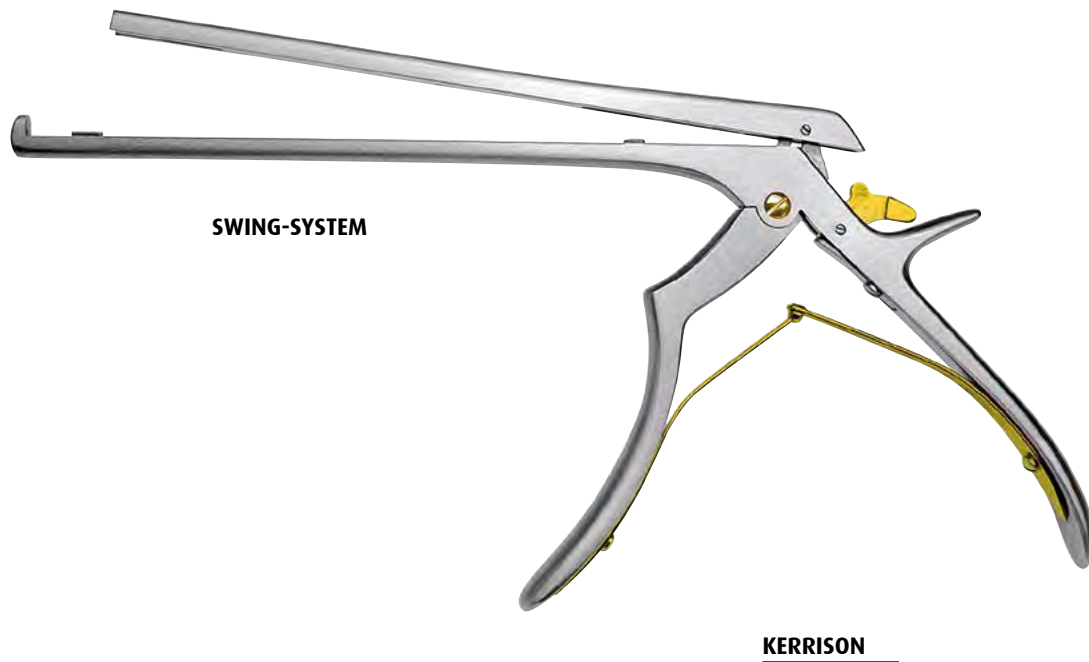

Schaftlänge Length of shaft Longitud del vástago Lunghezza dell'asta	Bissbreite / Width of bite / Anchura de la boca / Larghezza del morso					
	1 mm	2 mm	3 mm	4 mm	5 mm	6 mm
180 mm	1400-1051	1400-1052 E	1400-1053 E	1400-1054 E	1400-1055 E	1400-1056 E
200 mm	1400-1061	1400-1062 E	1400-1063 E	1400-1064 E	1400-1065 E	1400-1066 E
230 mm	1400-1071	1400-1072 E	1400-1073 E	1400-1074 E	1400-1075 E	1400-1076 E

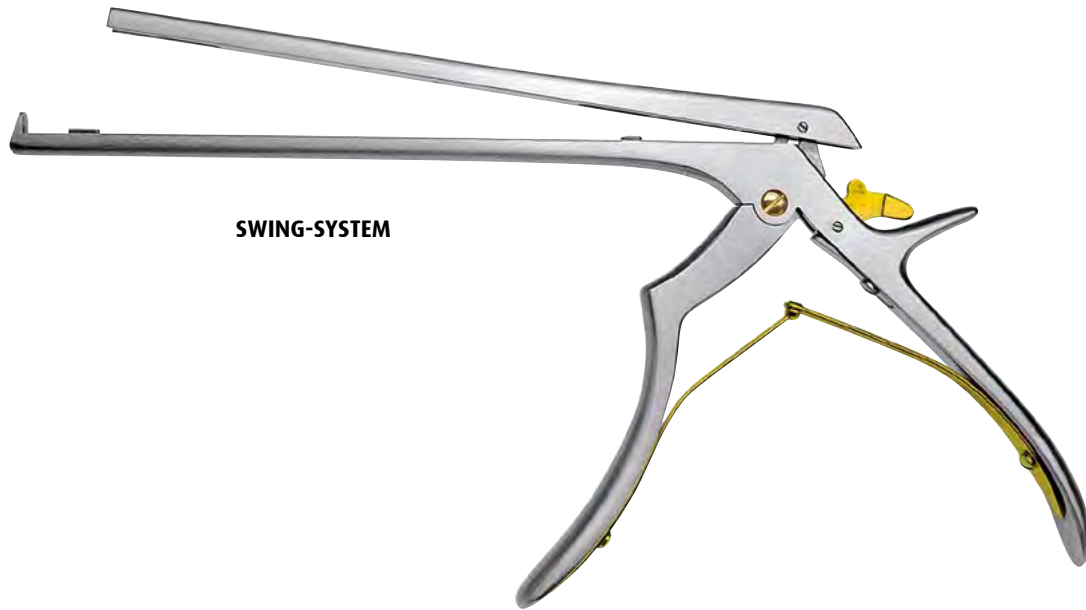

KERRISON

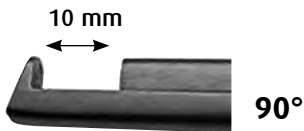

Dünnfuß (Mikro)
Thin footplate (Micro)
Lámina de punzonar estrecha (Micro)
Battente sottile

Schaftlänge Length of shaft Longitud del vástago Lunghezza dell'asta	Bissbreite / Width of bite / Anchura de la boca / Larghezza del morso				
	2 mm	3 mm	4 mm	5 mm	6 mm
180 mm	1400-1052 FE	1400-1053 FE	1400-1054 FE	1400-1055 FE	1400-1056 FE
200 mm	1400-1062 FE	1400-1063 FE	1400-1064 FE	1400-1065 FE	1400-1066 FE
230 mm	1400-1072 FE	1400-1073 FE	1400-1074 FE	1400-1075 FE	1400-1076 FE

Laminektomie-Stanzen
 Laminectomy Punches
 Pinzas cortantes para laminectomía
 Pinze per laminectomia

zerlegbar
 detachable
 desmontable
 smontabile

026

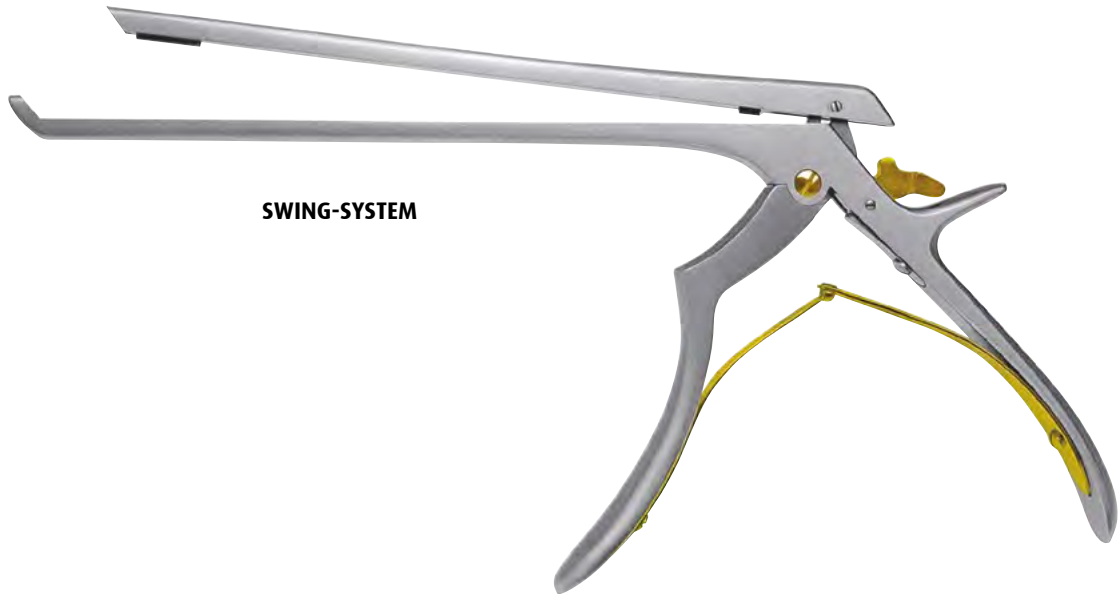

SWING-SYSTEM

KERRISON

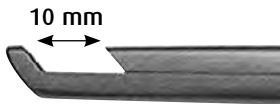

130° (40°)

Schaftlänge Length of shaft Longitud del vástago Lunghezza dell'asta	Bissbreite / Width of bite / Anchura de la boca / Larghezza del morso					
	1 mm	2 mm	3 mm	4 mm	5 mm	6 mm
180 mm	1400-1151	1400-1152	1400-1153	1400-1154	1400-1155	1400-1156
200 mm	1400-1161	1400-1162	1400-1163	1400-1164	1400-1165	1400-1166
230 mm	1400-1171	1400-1172	1400-1173	1400-1174	1400-1175	1400-1176

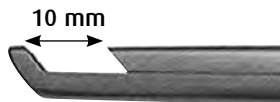

130° (40°)

mit Auswerfer
 with ejector
 con espulsor
 con espulsore

Schaftlänge Length of shaft Longitud del vástago Lunghezza dell'asta	Bissbreite / Width of bite / Anchura de la boca / Larghezza del morso			
	3 mm	4 mm	5 mm	6 mm
180 mm	1400-1153 E	1400-1154 E	1400-1155 E	1400-1156 E
200 mm	1400-1163 E	1400-1164 E	1400-1164 E	1400-1166 E
230 mm	1400-1173 E	1400-1174 E	1400-1175 E	1400-1176 E

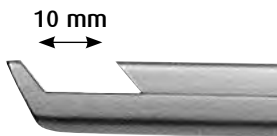
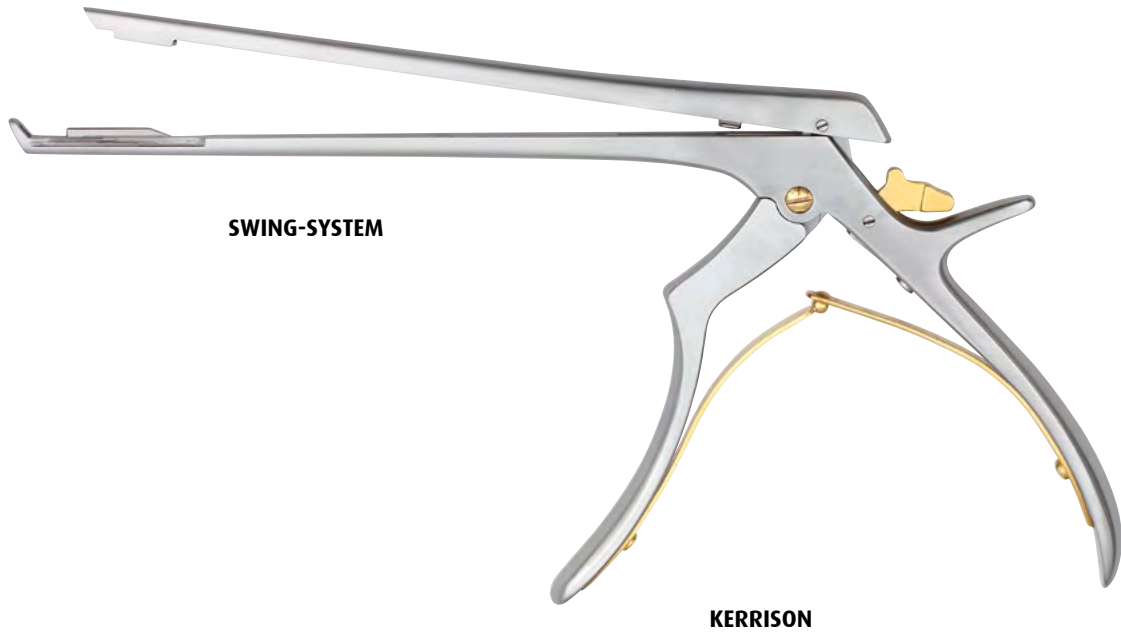

130° (40°)

Dünnpfuß (Mikro)
 Thin footplate (Micro)
 Lámina de punzonar estrecha (Micro)
 Battente sottile

Schaftlänge Length of shaft Longitud del vástago Lunghezza dell'asta	Bissbreite / Width of bite / Anchura de la boca / Larghezza del morso					
	1 mm	2 mm	3 mm	4 mm	5 mm	6 mm
180 mm	1400-1151 F	1400-1152 F	1400-1153 F	1400-1154 F	1400-1155 F	1400-1156 F
200 mm	1400-1161 F	1400-1162 F	1400-1163 F	1400-1164 F	1400-1165 F	1400-1166 F
230 mm	1400-1171 F	1400-1172 F	1400-1173 F	1400-1174 F	1400-1175 F	1400-1176 F

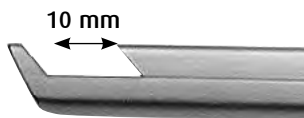

130° (40°)

Dünnpfuß (Mikro)
 Thin footplate (Micro)
 Lámina de punzonar estrecha (Micro)
 Battente sottile

mit Auswerfer
 with ejector
 con espulsor
 con espulsore

Schaftlänge Length of shaft Longitud del vástago Lunghezza dell'asta	Bissbreite / Width of bite / Anchura de la boca / Larghezza del morso			
	3 mm	4 mm	5 mm	6 mm
180 mm	1400-1153 FE	1400-1154 FE	1400-1155 FE	1400-1156 FE
200 mm	1400-1163 FE	1400-1164 FE	1400-1165 FE	1400-1166 FE
230 mm	1400-1173 FE	1400-1174 FE	1400-1175 FE	1400-1176 FE

Laminektomie-Stanzen
Laminectomy Punches
Pinzas cortantes para laminectomía
Pinze per laminectomia

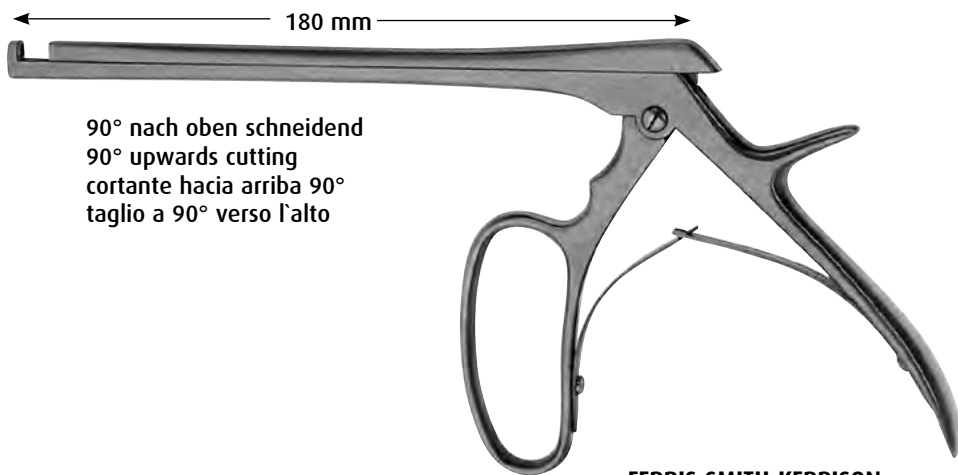

90° nach oben schneidend
 90° upwards cutting
 cortante hacia arriba 90°
 taglio a 90° verso l'alto

FERRIS-SMITH-KERRISON

1400-2703 3,0 mm

1400-2705 5,0 mm

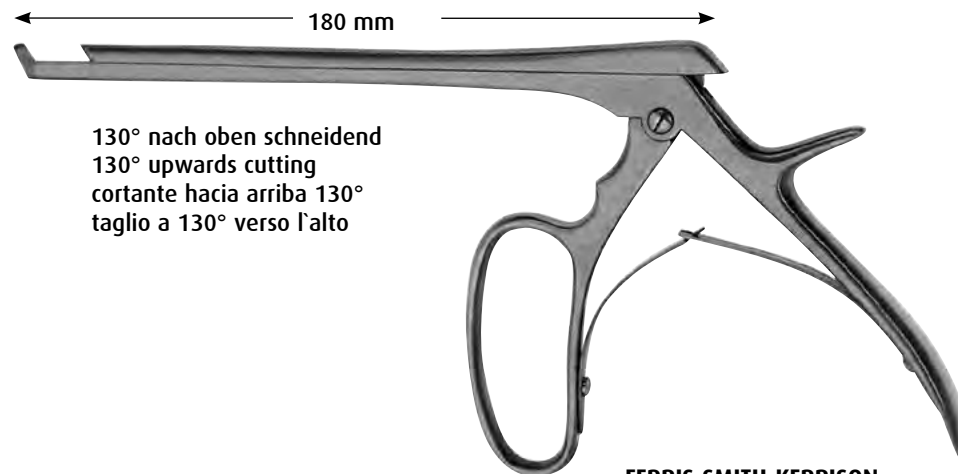

130° nach oben schneidend
 130° upwards cutting
 cortante hacia arriba 130°
 taglio a 130° verso l'alto

FERRIS-SMITH-KERRISON

a = 180 mm a = 200 mm

1400-2723 1400-2773

3,0 mm

1400-2725 1400-2775

5,0 mm

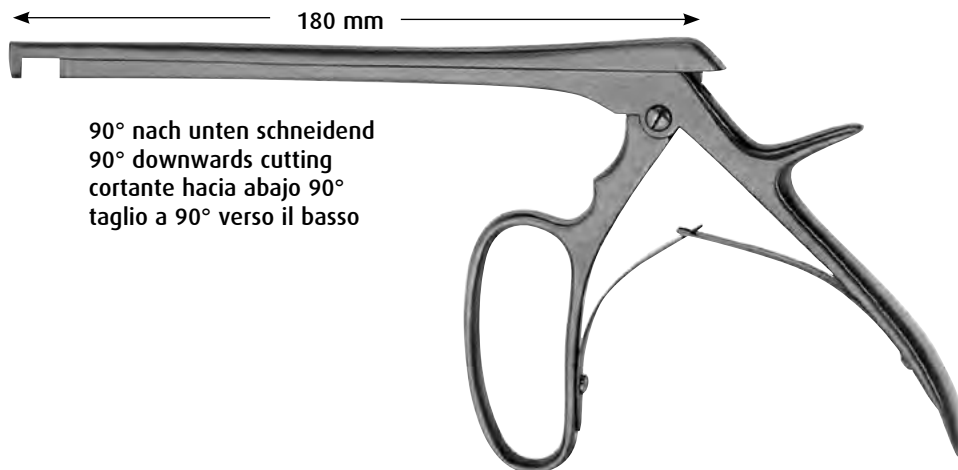

90° nach unten schneidend
 90° downwards cutting
 cortante hacia abajo 90°
 taglio a 90° verso il basso

FERRIS-SMITH-KERRISON

1400-2713 3,0 mm

1400-2715 5,0 mm

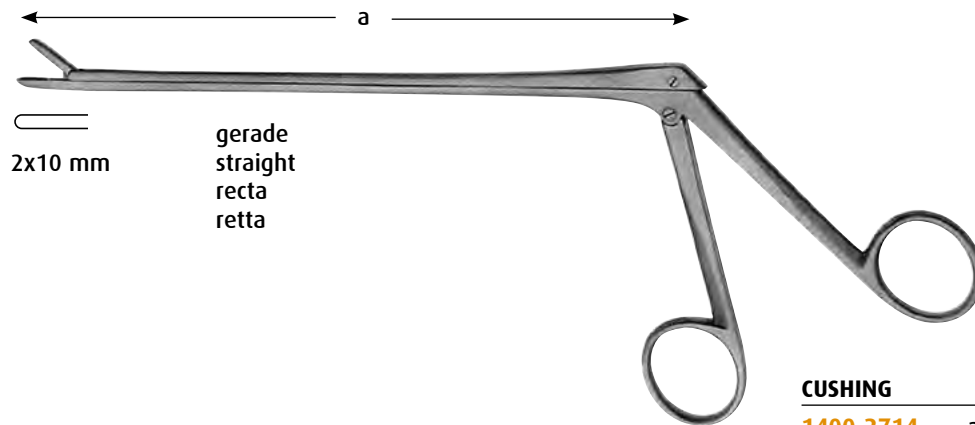

**CUSHING**

1400-2714	a = 130 mm
1400-2815	a = 150 mm
1400-2832	a = 180 mm

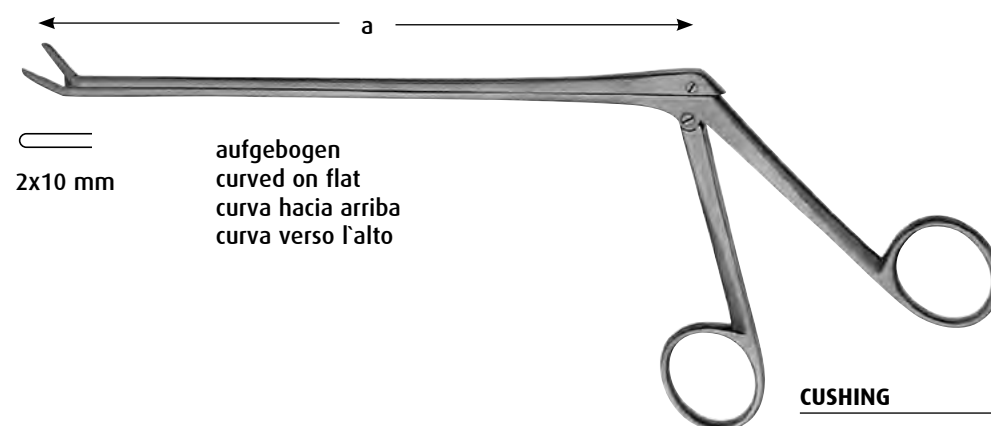
**CUSHING**

1400-2840	a = 130 mm
1400-2841	a = 150 mm
1400-2842	a = 180 mm

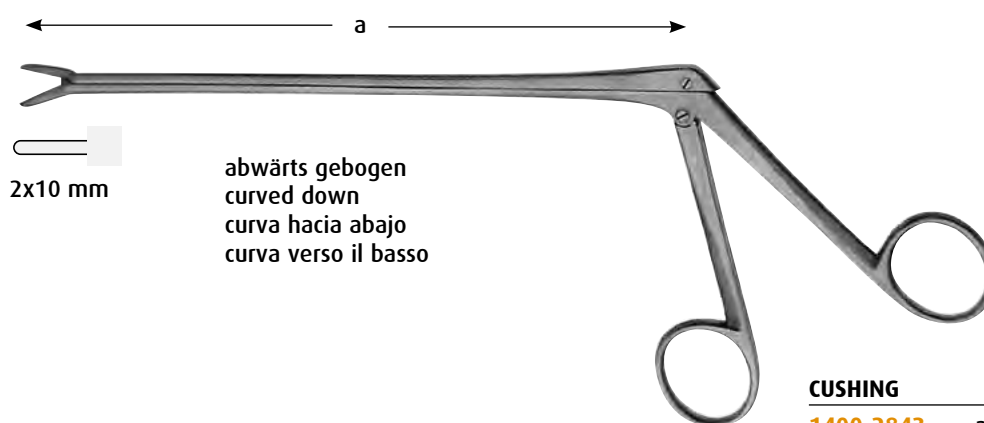
**CUSHING**

1400-2843	a = 130 mm
1400-2844	a = 150 mm
1400-2845	a = 180 mm

Laminektomie-Zangen
Laminectomy Rongeurs
Pinzas cortantes para laminectomía
Pinze per laminectomia

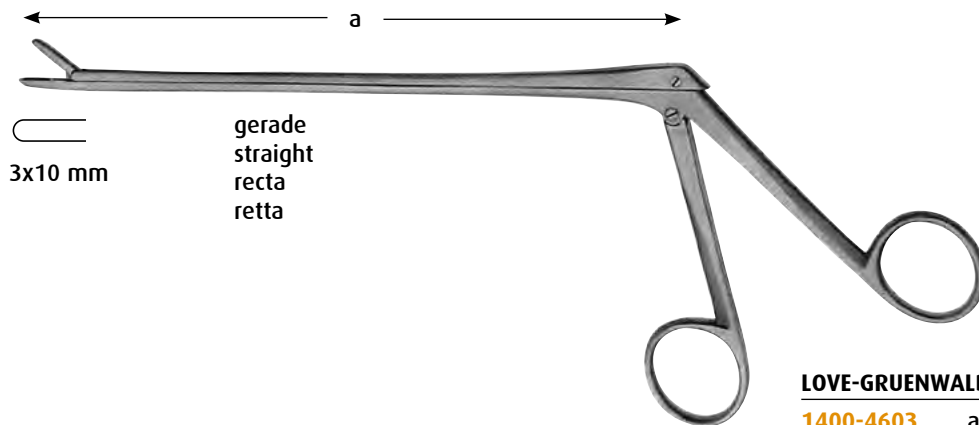

3x10 mm
 gerade
 straight
 recta
 retta

LOVE-GRUENWALD

- | | |
|-----------|------------|
| 1400-4603 | a = 130 mm |
| 1400-5003 | a = 150 mm |
| 1400-6603 | a = 180 mm |

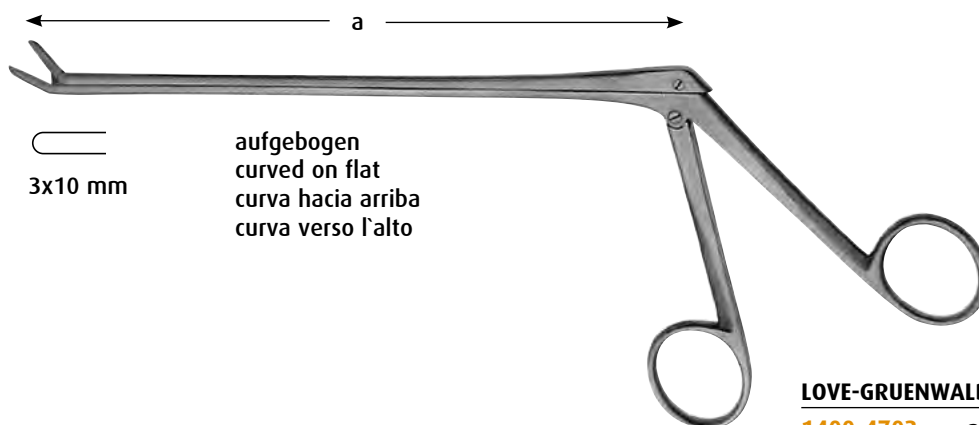

3x10 mm
 aufgebogen
 curved on flat
 curva hacia arriba
 curva verso l'alto

LOVE-GRUENWALD

- | | |
|-----------|------------|
| 1400-4703 | a = 130 mm |
| 1400-5103 | a = 150 mm |
| 1400-6703 | a = 180 mm |

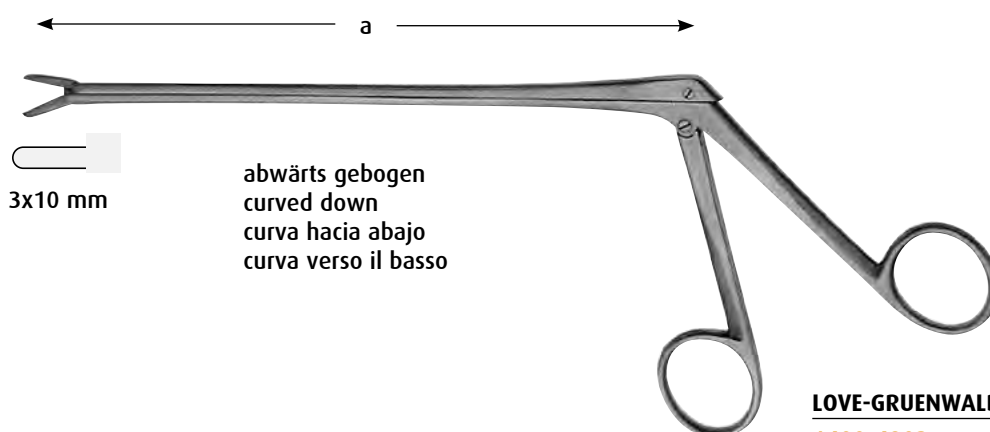

3x10 mm
 abwärts gebogen
 curved down
 curva hacia abajo
 curva verso il basso

LOVE-GRUENWALD

- | | |
|-----------|------------|
| 1400-4903 | a = 130 mm |
| 1400-5303 | a = 150 mm |
| 1400-6903 | a = 180 mm |

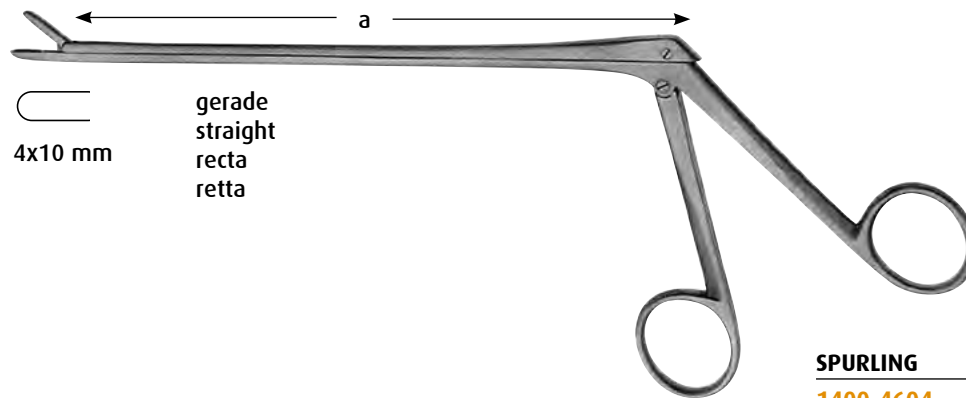
**SPURLING**

1400-4604	a = 130 mm
1400-5004	a = 150 mm
1400-6604	a = 180 mm

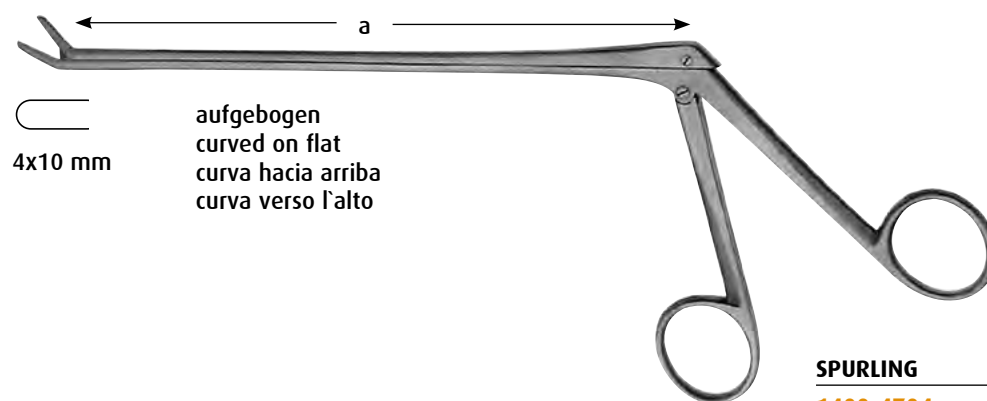
**SPURLING**

1400-4704	a = 130 mm
1400-5104	a = 150 mm
1400-6704	a = 180 mm

**SPURLING**

1400-4904	a = 130 mm
1400-5304	a = 150 mm
1400-6904	a = 180 mm

Laminektomie-Zangen
Laminectomy Rongeurs
Pinzas cortantes para laminectomía
Pinze per laminectomia

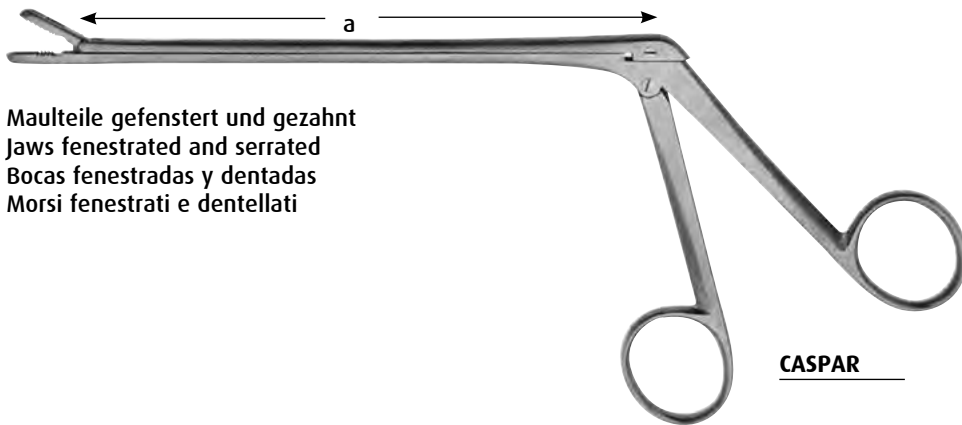

Maulteile gefenestert und gezahnt
 Jaws fenestrated and serrated
 Bocas fenestradas y dentadas
 Morsi fenestrati e dentellati

Schaftlänge Length of shaft Longitud del vástago Lunghezza dell'asta	Bissbreite / Width of bite / Anchura de la boca / Larghezza del morso				
a = 140 mm	1400-5402	1400-5403	1400-5404	1400-5405	1400-5406
a = 160 mm	1400-5602	1400-5603	1400-5604	1400-5605	1400-5606
a = 185 mm	1400-5802	1400-5803	1400-5804	1400-5805	1400-5806

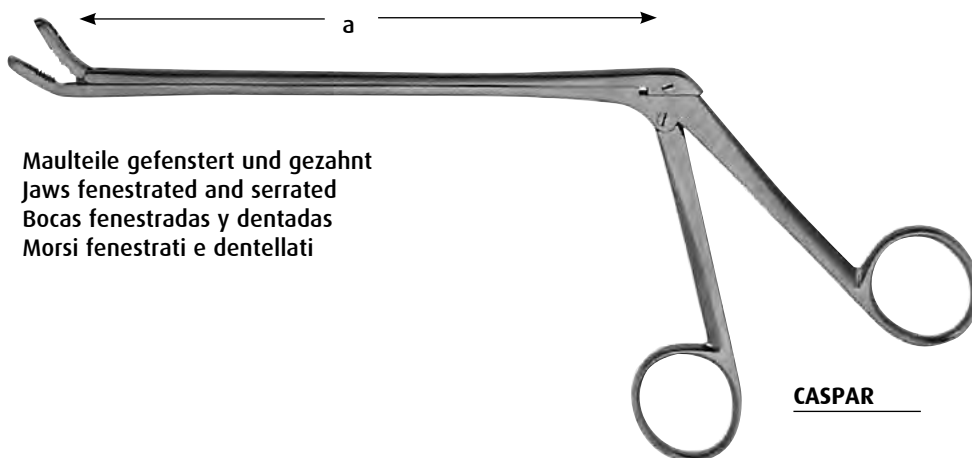





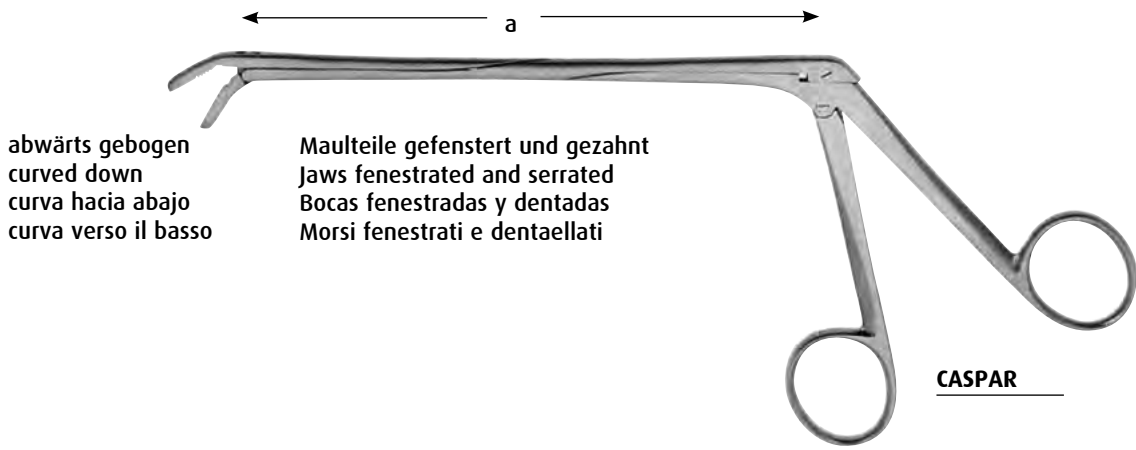

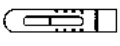
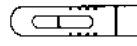

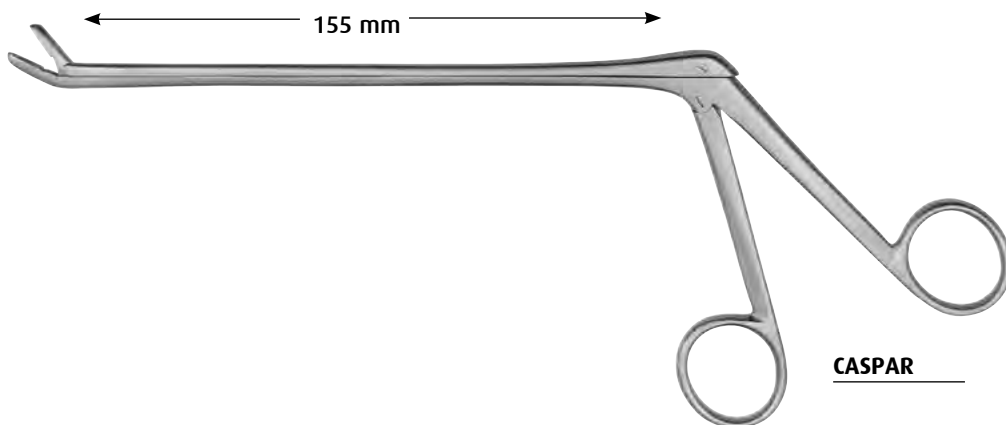
Maulteile gefenestert und gezahnt
 Jaws fenestrated and serrated
 Bocas fenestradas y dentadas
 Morsi fenestrati e dentellati

Schaftlänge Length of shaft Longitud del vástago Lunghezza dell'asta	Bissbreite / Width of bite / Anchura de la boca / Larghezza del morso		
a = 140 mm	1400-5503	1400-5504	1400-5505
a = 160 mm	1400-5703	1400-5704	1400-5705
a = 185 mm	1400-5903	1400-5904	1400-5905



Schaftlänge Length of shaft Longitud del vástago Lunghezza dell'asta	Bissbreite / Width of bite / Anchura de la boca / Larghezza del morso	
		
	3,0 x 12,0 mm	4,0 x 14,0 mm
a = 140 mm	1400-6103	1400-6104
a = 160 mm	1400-6302	1400-6304
a = 185 mm	1400-6503	1400-6504



	Bissbreite / Width of bite / Anchura de la boca / Larghezza del morso			
				
	2,0 x 12,0 mm	3,0 x 13,0 mm	4,0 x 14,0 mm	5,0 x 14,0 mm
	1400-7002	1400-7003	1400-7004	1400-7005
	1400-7012	1400-7013	1400-7014	1400-7015
	1400-7022	1400-7023	1400-7024	1400-7025

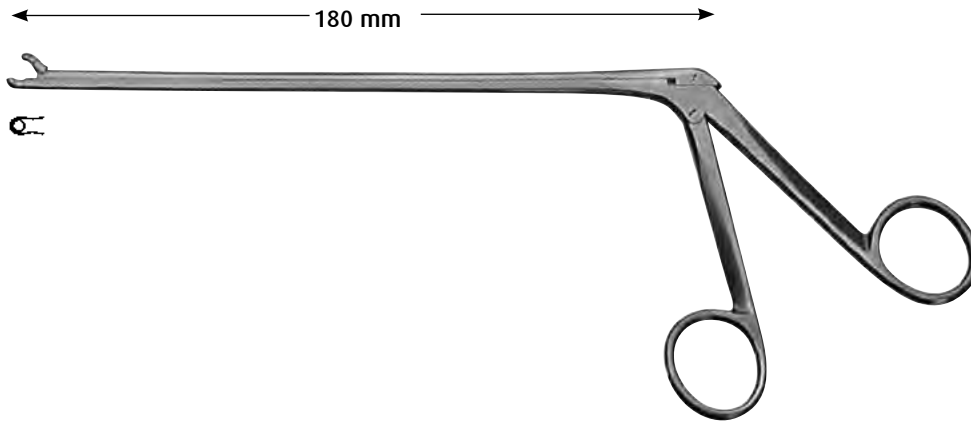

YASARGIL
1400-7622 Ø 2,0 mm

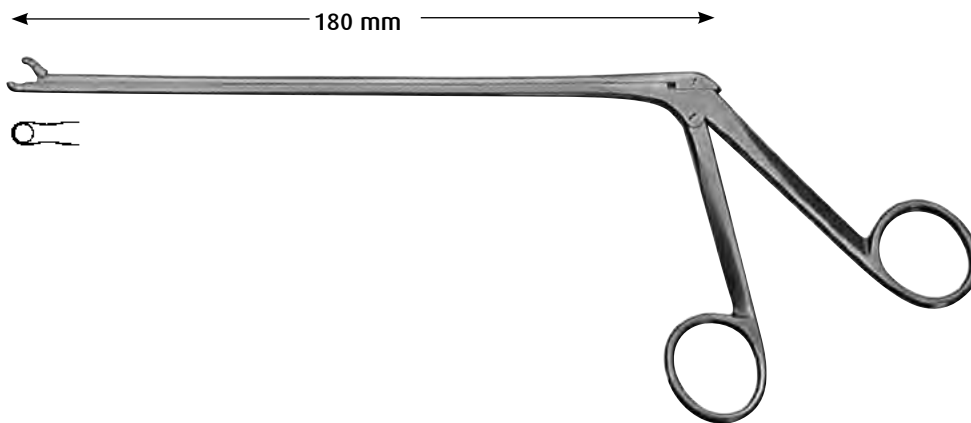

OLDBERG
1400-7735 Ø 3,5 mm

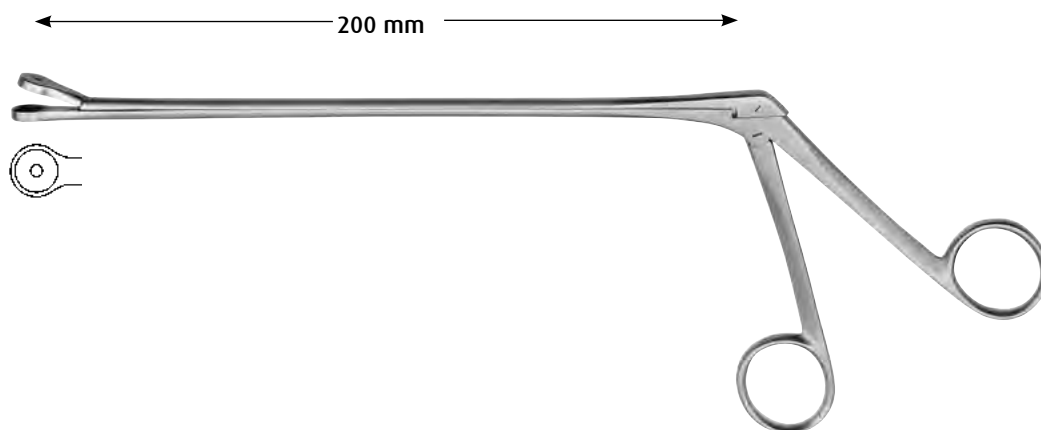



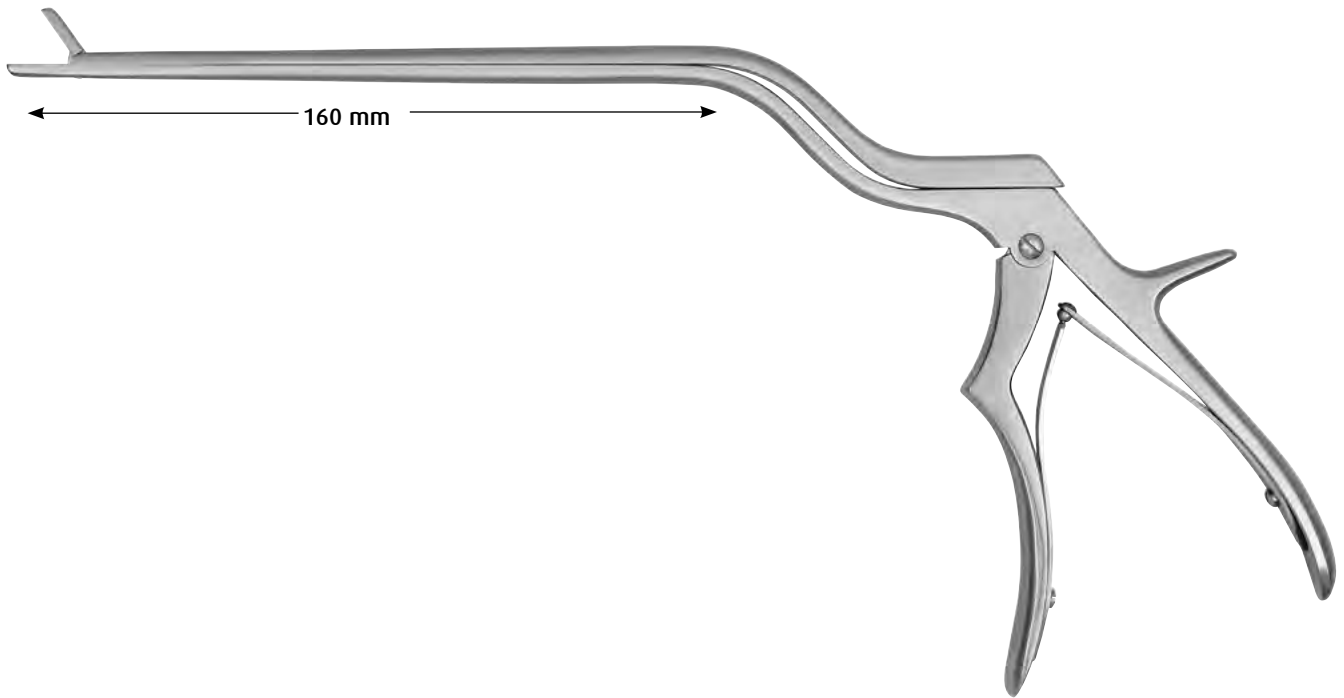

LANDOLT
1400-7409 Ø 9,0 mm

026

**Laminektomie-Zangen
Laminectomy Rongeurs
Pinzas cortantes para laminectomía
Pinze per laminectomia**



	Bissbreite / Width of bite / Anchura de la boca / Larghezza del morso		
			
	2,0 x 8,0 mm	3,0 x 9,0mm	4,0 x 10,0 mm
	1400-2002	1400-2003	1400-2004
	1400-2005	1400-2006	1400-2007

Laminektomie-Zangen
Laminectomy Rongeurs
Pinzas cortantes para laminectomía
Pinze per laminectomia

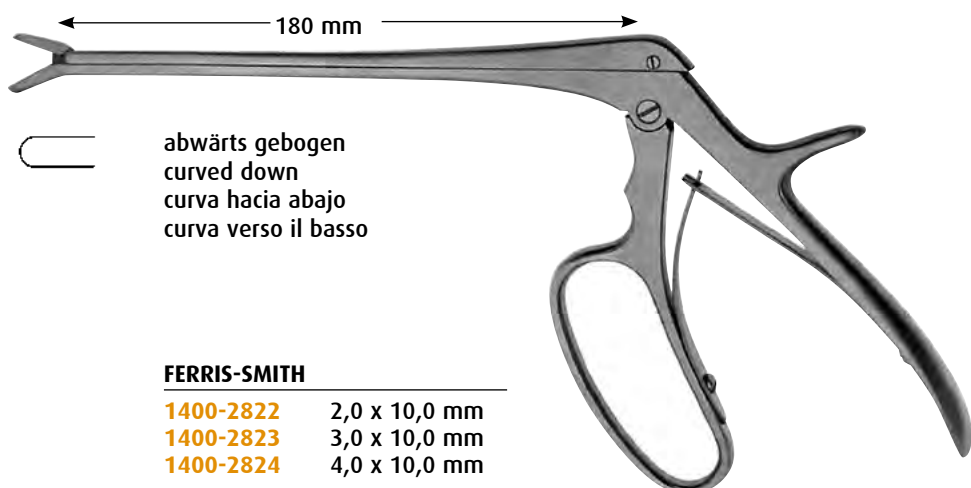
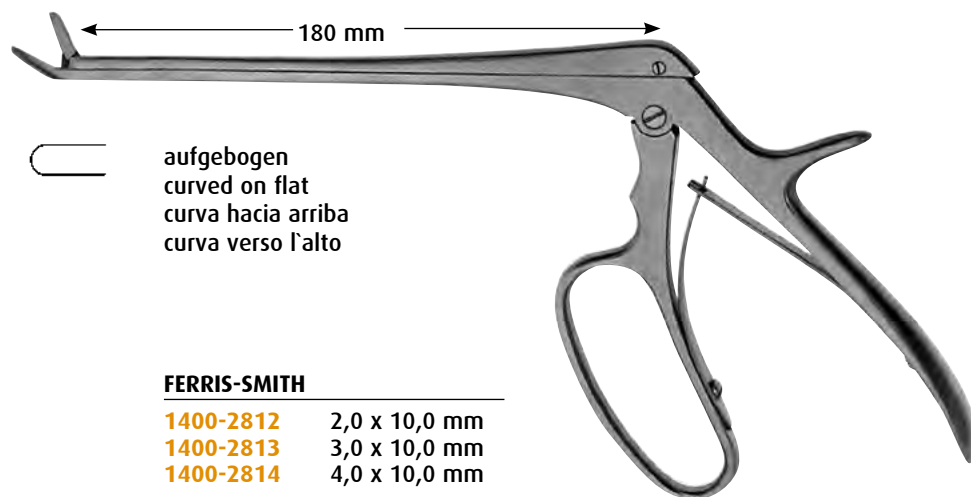
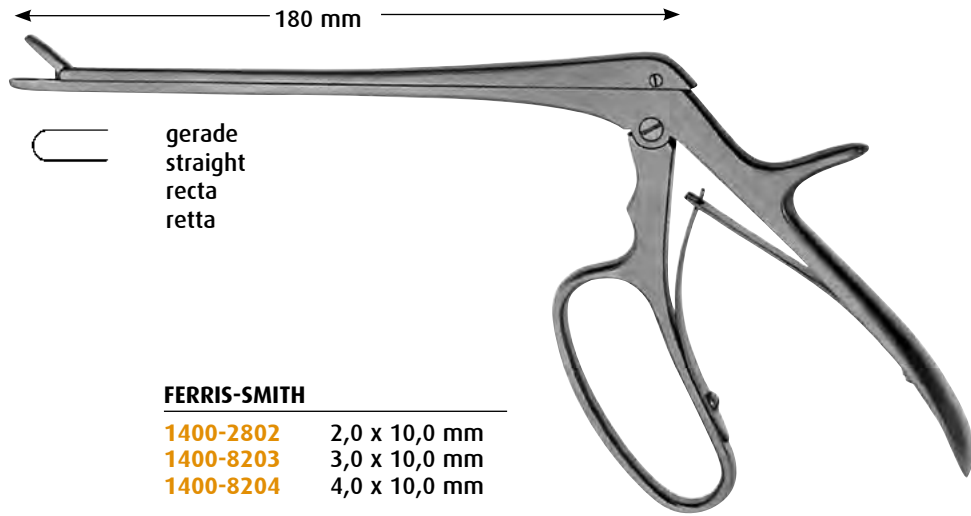

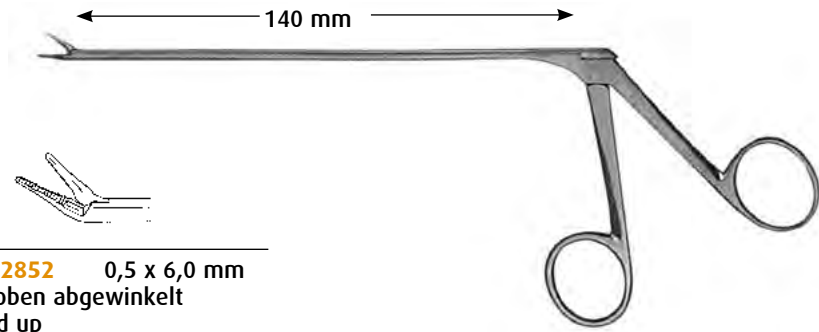

1400-2850 0,5 x 6,0 mm
 gerade
 straight
 recta
 retta

1400-2852 0,5 x 6,0 mm
 nach oben abgewinkelt
 angled up
 angulada hacia arriba
 angolata in alto



1400-2854 0,5 x 6,0 mm
 nach rechts gebogen
 curved to right
 curva a la derecha
 curve a destra

1400-2856 0,5 x 6,0 mm
 nach links gebogen
 curved to left
 curva a la izquierda
 curve a sinistra

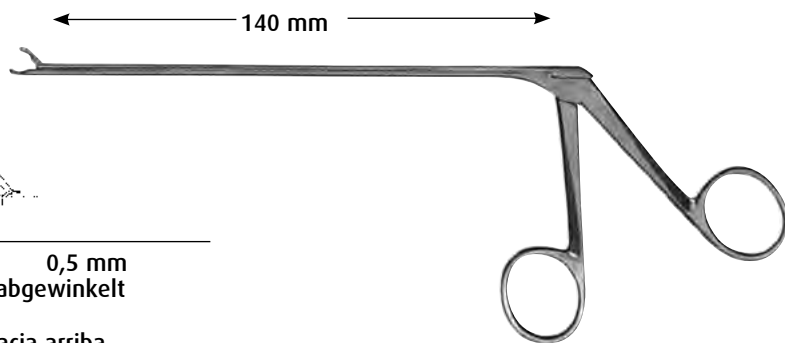

1400-2858 0,5 mm
1400-2860 1,0 mm
 gerade
 straight
 recta
 retta

1400-2862 0,5 mm
 nach oben abgewinkelt
 angled up
 angulada hacia arriba
 angolata in alto



1400-2864 0,5 mm
1400-2866 1,0 mm
 nach rechts gebogen
 curved to right
 curva a la derecha
 curve a destra

1400-2868 0,5 mm
1400-2870 1,0 mm
 nach links gebogen
 curved to left
 curva a la izquierda
 curve a sinistra

Mikro-Zangen für Neurochirurgie
Micro Forceps for Neurosurgery
Micro Pinzas para Neurocirugía
Micro Pinze per Neurochirurgia

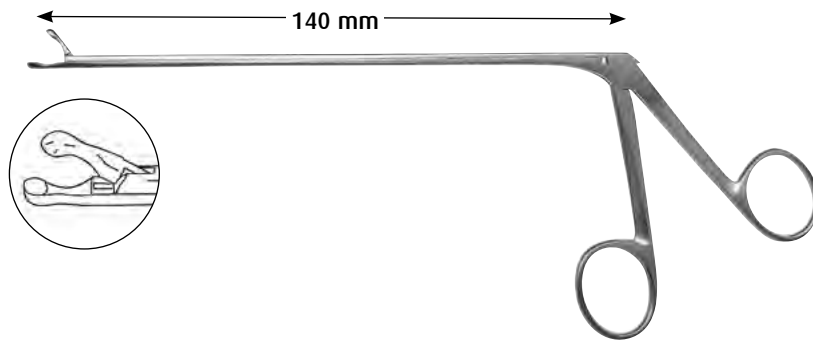

- | | | |
|------------------|----------|--|
| 1400-2872 | Ø 2,0 mm | |
| 1400-2874 | Ø 3,0 mm | |

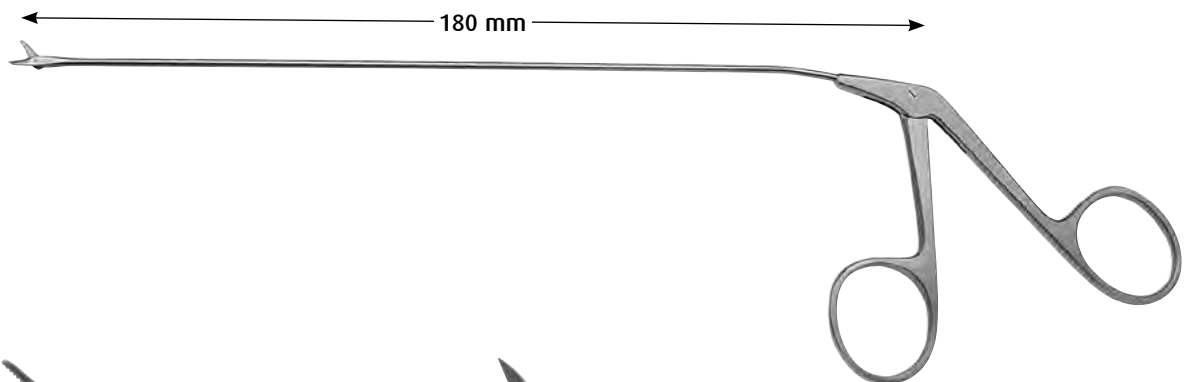

YASARGIL
1400-2876 Ø 2,0 mm



NICOLA
1400-2878 Ø 2,0 mm



NICOLA
1400-2880 Ø 2,0 mm

027

**Magen, Darm, Urologie
Stomach, Intestines, Urology
Estómago, Intestinos, Urología
Stomaco, Intestini, Urologia**





ALLIS-BABY

- 1157-6612 12,0 cm / 4³/₄"
- 1157-6714 14,0 cm / 5¹/₂"



ALLIS

- 1157-6614 15,0 cm / 6"
- 1157-6719 19,0 cm / 7¹/₂"



ALLIS

- 1157-6615 15,0 cm / 6"
- 1157-6619 19,0 cm / 7¹/₂"
- 1157-7022 22,0 cm / 8³/₄"
- 1157-6625 25,0 cm / 9³/₄"

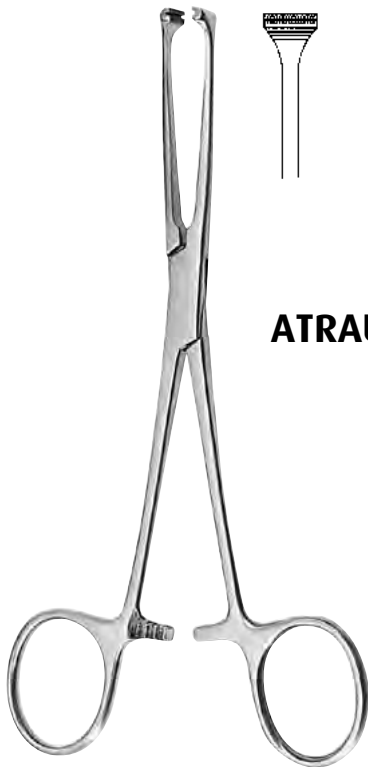

ATRAUMA

ALLIS

- 1157-6816 16,0 cm / 6¹/₄"
- 1157-6820 20,0 cm / 8"
- 1157-6825 25,0 cm / 9³/₄"
- 1157-6830 30,0 cm / 11¹/₄"



ALLIS-ADAIR

- 1157-7615 15,5 cm / 6"

Darm- und Gewebefäßzangen
Intestinal and Tissue Grasping Forceps
Pinzas intestinales y para tejidos
Pinze da presa per intestino e tessuti

027



BOYS-ALLIS
1157-7415 15,0 cm / 6"



JUDD-ALLIS
1157-6503 15,0 cm / 6"
1157-7219 19,0 cm / 7½"



THOMS-ALLIS
1157-7020 20,0 cm / 8"



ALLIS
1157-6622 20,0 cm / 8"

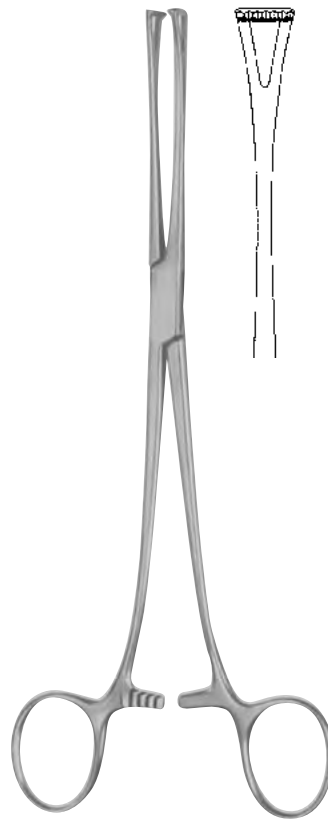

LOCKWOOD-ALLIS
1157-5820 20,0 cm / 8"

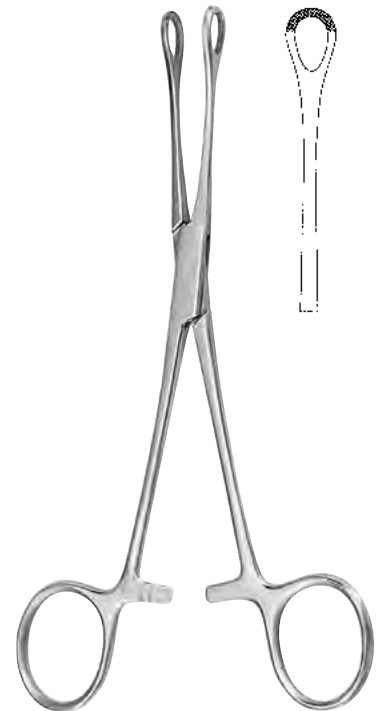

WILLIAMS
1157-4416 16,0 cm / 6¼"



LITTLEWOOD

1157-7319 18,5 cm / 7¹/₄"

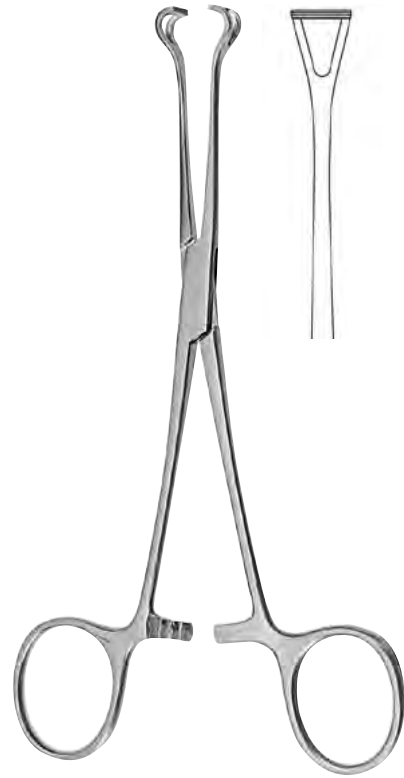

BABCOCK

1157-6014 14,0 cm / 5¹/₂"
1157-6016 16,0 cm / 6¹/₄"
1157-6018 18,0 cm / 7"
1157-6020 20,0 cm / 8"
1157-6024 24,0 cm / 9¹/₂"

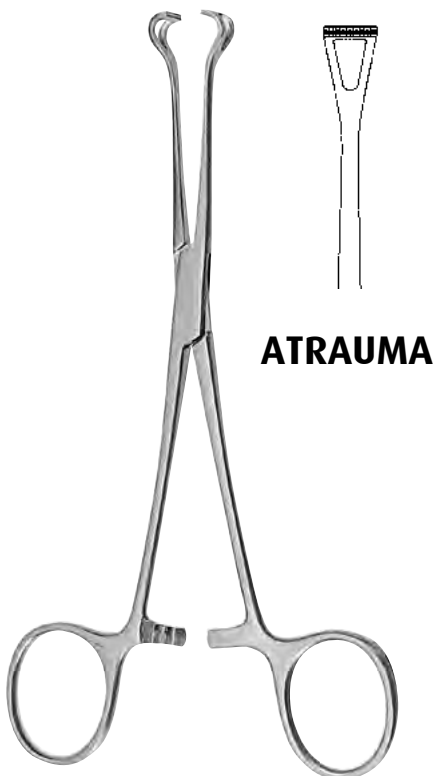

BABCOCK

1157-6216 16,0 cm / 6¹/₄"
1157-6220 20,0 cm / 8"



BABCOCK-TC

1157-6416 16,0 cm / 6¹/₄"
1157-6420 20,0 cm / 8"

Darm- und Gewebefäßzangen
Intestinal and Tissue Grasping Forceps
Pinzas intestinales y para tejidos
Pinze da presa per intestino e tessuti



DUVAL

1157-5018 18,0 cm / 7"
1157-5020 20,0 cm / 8"

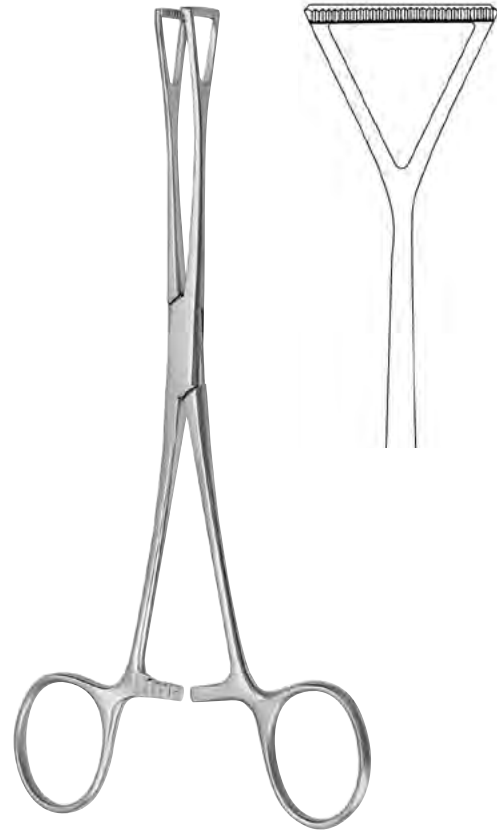

DUVAL

1157-5220 20,0 cm / 8"
1157-5223 23,0 cm / 9"



DUVAL-TC

1157-5320 20,0 cm / 8"

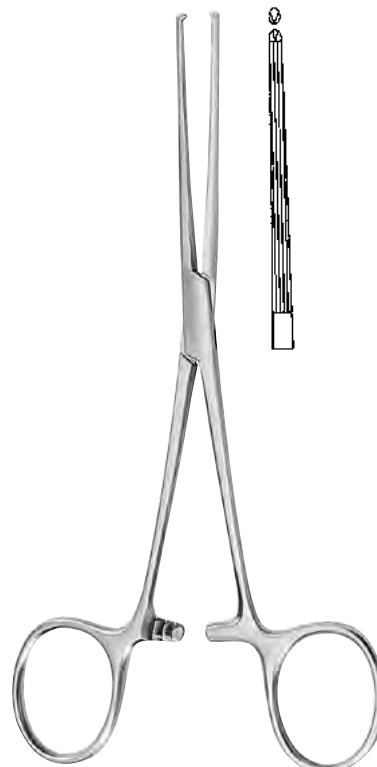

ALLEN

1331-0015 15,5 cm / 6"

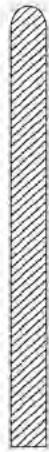

1331-0818

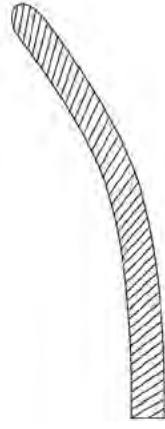

1331-0918

Darmklemmen
 Intestinal Clamp Forceps
 Pinzas-clamps intestinales
 Pinze intestinali

BABY-DOYEN

1331-0818 - 1331-0918

18,0 cm / 7"

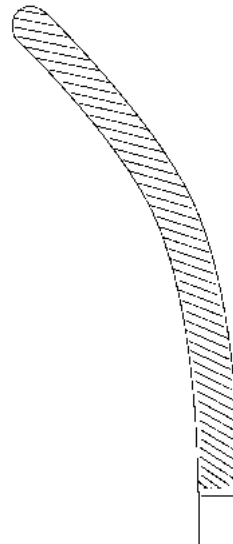
1331-1420
1331-26231331-1520
1331-2723**DOYEN**1331-1420 - 1331-1520
1331-2623 - 1331-272321,0 cm / 8¹/₄"
23,0 cm / 9"

Darmklemmen
Intestinal Clamps Forceps
Pinzas clamps intestinales
Pinze intestinali

027



1131-4421
 1131-4423
 1331-4425

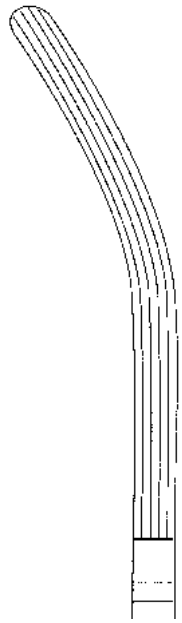

1131-4521
 1331-4523
 1331-4525

MAYO-ROBSON

1131-4421 - 1131-4521 21,0 cm / 8¹/₄"
 1131-4423 - 027-221-230 23,0 cm / 9"
 1331-4425 - 1331-4525 25,0 cm / 9³/₄"

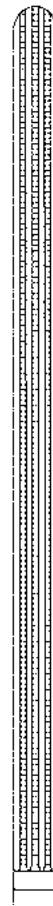

1331-3222
 1331-3225
 1331-3228

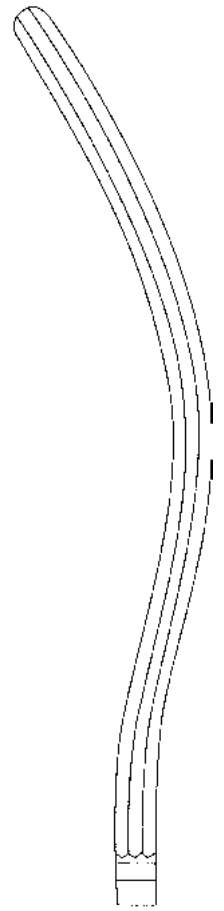

1331-3322
 1331-3325
 1331-3328

KOCHER

1331-3222 - 1331-3322 22,0 cm / 8³/₄"
 1331-3225 - 1331-3325 25,0 cm / 9³/₄"
 1331-3228 - 1331-3328 28,0 cm / 11"



1331-4633

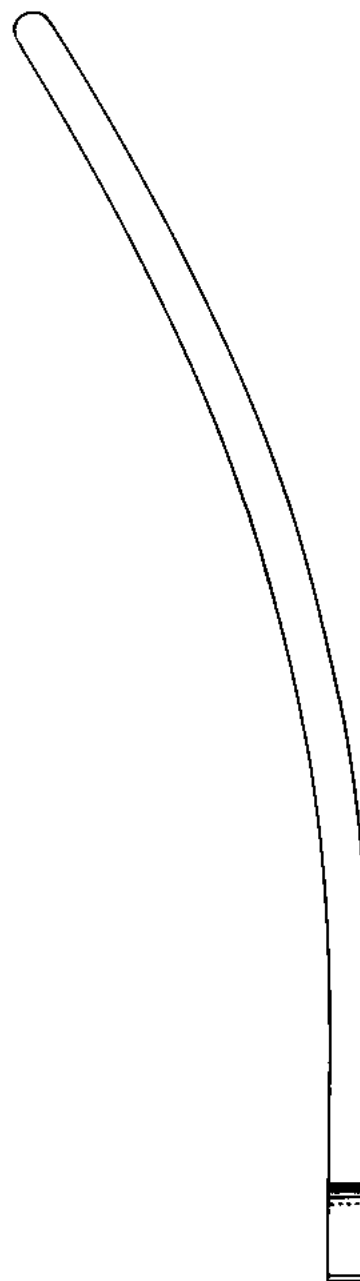

1331-4733

SCUDDER

1331-4633 - 1331-4733

33,0 cm / 13"

Darm- und Magenklammern
Intestinal and Stomach Clamp Forceps
Pinzas-clamps gastro-intestinales
Pinze per intestino e stomaco

027

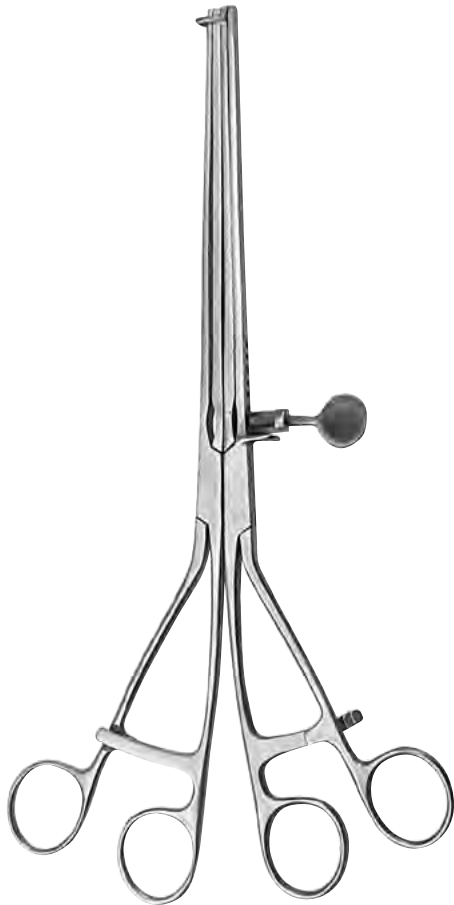

1331-6030

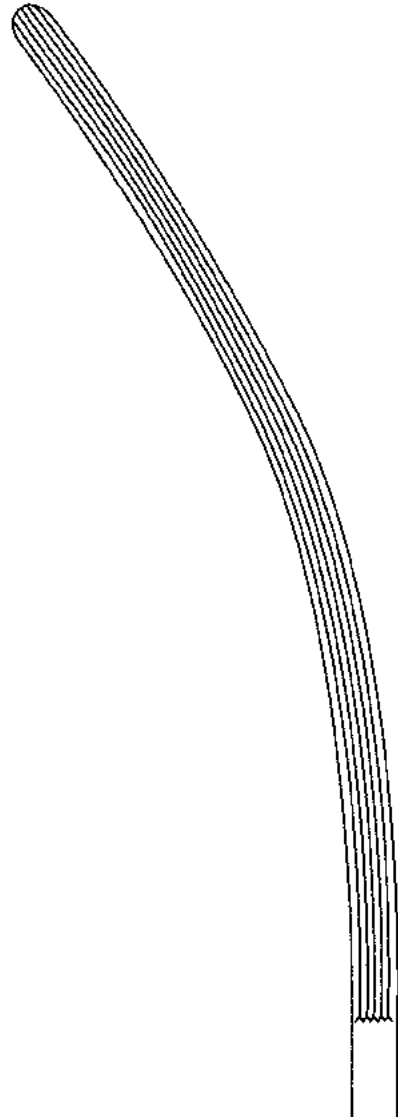

1331-6130

LANE

1331-6030 - 1331-6130

30,0 cm / 11³/₄"

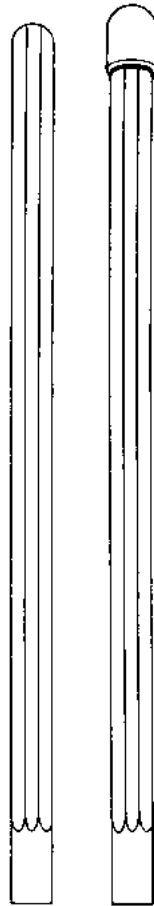

1331-4025
 1331-4130

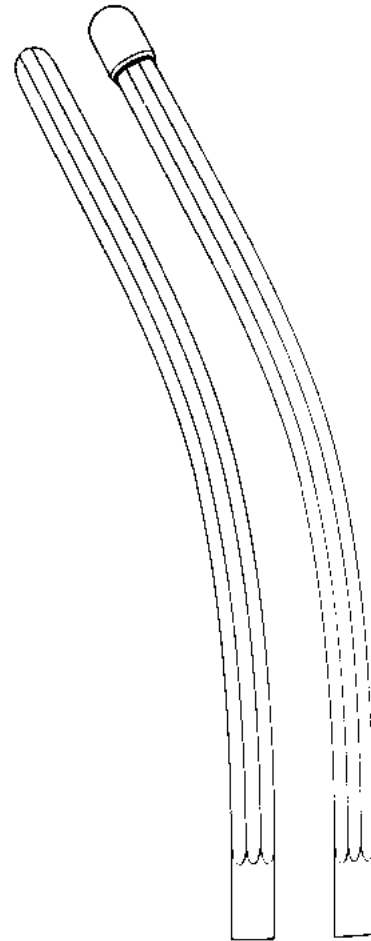

1331-4125
 1331-4230

NUSSBAUM

1331-4025 - 1331-4125
 1331-4130 - 1331-4230

25,0 cm / 9³/₄"
 30,0 cm / 11³/₄"

Darm- und Magenklammern
Intestinal and Stomach Clamp Forceps
Pinzas-clamps gastro-intestinales
Pinze per intestino e stomaco

027

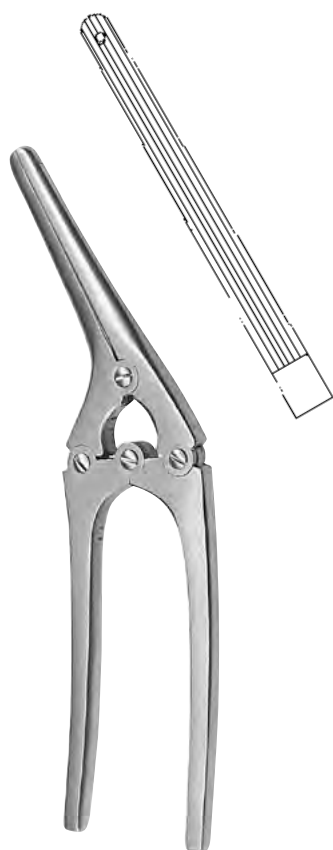

PAYR-BABY

1331-6718 15,0 cm / 6"

mit Stift
with pin
con espiga
con perno

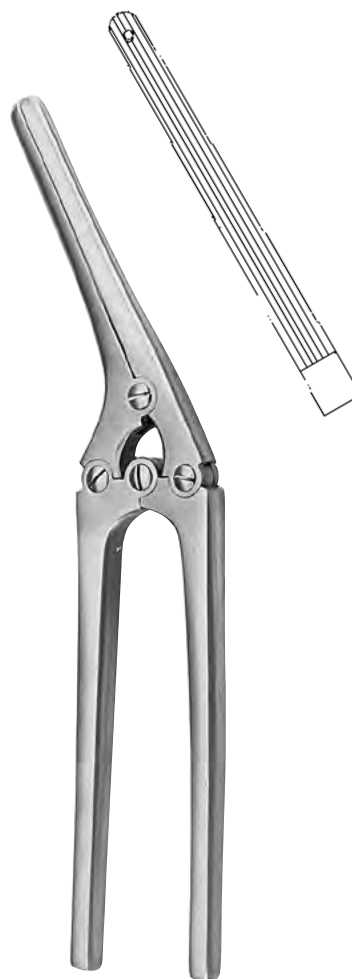

PAYR

1331-6720 21,0 cm / 8¹/₄"
1331-6727 29,0 cm / 11¹/₃"
1331-6731 35,0 cm / 13³/₄"

mit Stift
with pin
con espiga
con perno

**DE MARTEL-WOLFSON**

1331-1201	5,0 cm / 2"
1331-1202	7,0 cm / 2 1/2"
1331-1203	10,0 cm / 4"

**DE MARTEL-WOLFSON**

1331-1300	26,0 cm / 10 1/4"
------------------	-------------------

**DE MARTEL-WOLFSON**

1331-1308	8,5 cm / 3 1/2"
------------------	-----------------

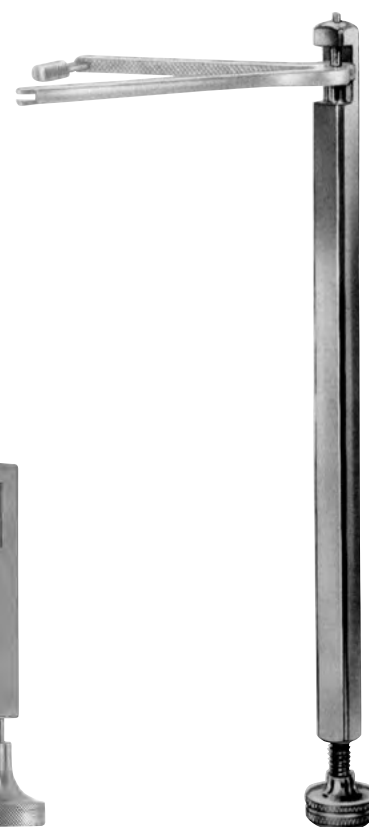
**DE MARTEL-WOLFSON**

1331-1323	23,0 cm / 9"
------------------	--------------

ATRAUMA



1157-3225 25,0 cm / 9³/₄"

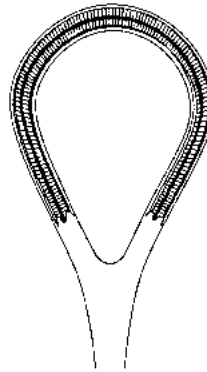

1157-3226 26,0 cm / 10¹/₄"



1157-5518 18,0 cm / 7"

schmal
 narrow
 estrecho
 stretto

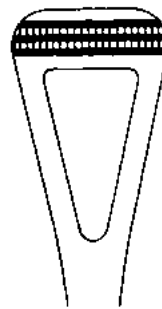

1157-5520 20,5 cm / 8"

mittel
 medium
 mediano
 medio

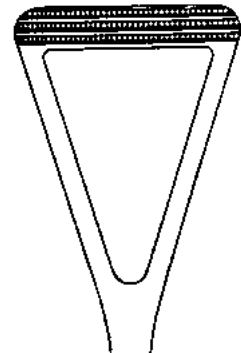

1157-5523 23,0 cm / 9"

breit
 wide
 ancho
 largo

SCHEIBE

ATRAUMA



1331-1013



1331-1017

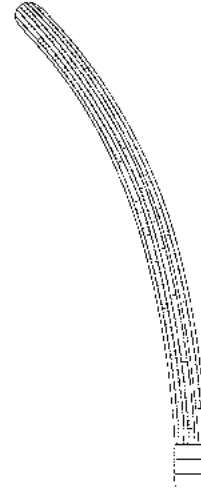

1331-1113

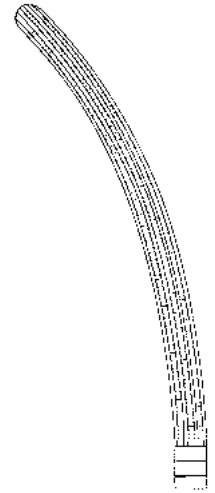

1331-1117

BABY-DOYEN

1331-1013 - 1331-1113

13,0 cm / 5¹/₈"

1331-1017 - 1331-1117

16,0 cm / 6¹/₄"

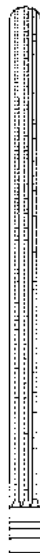

1331-1018



1331-1021



1331-1023

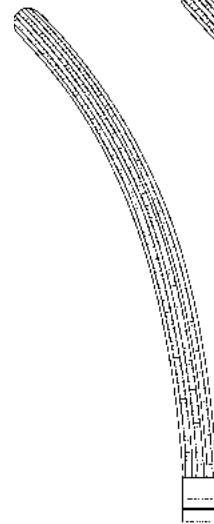

1331-1118



1331-1121

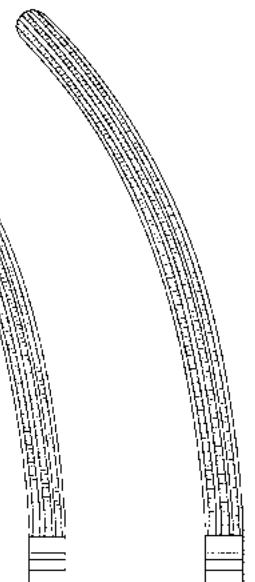

1331-1123

DOYEN

1331-1018 - 1331-1023

18,0 cm / 7"

1331-1021 - 1331-1121

21,0 cm / 8¹/₄"

1331-1118 - 1331-1123

23,0 cm / 9"

ATRAUMA



1331-4625



1331-4725

MAYO-ROBSON

1331-4625 - 1331-4725

25,0 cm / 9³/₄"



KOCHER

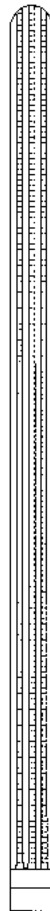

1331-3422
 1331-3425
 1331-3428

22,0 cm / 8³/₄"
 25,0 cm / 9³/₄"
 28,0 cm / 11"

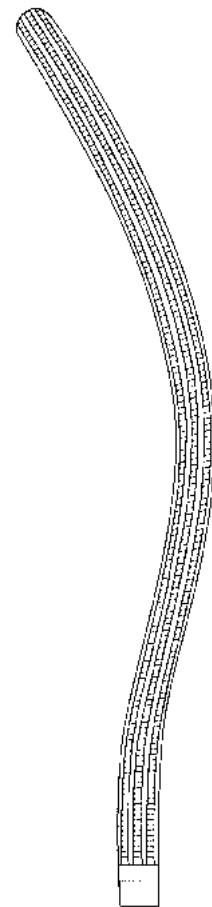

1331-3522
 1331-3525
 1331-3528

22,0 cm / 8³/₄"
 25,0 cm / 9³/₄"
 28,0 cm / 11"

027

Darm- und Magenklappen
Intestinal and Stomach Clamp Forceps
Pinzas-clamps intestinales y estomacales
Pinze per intestino e stomaco

ATRAUMA

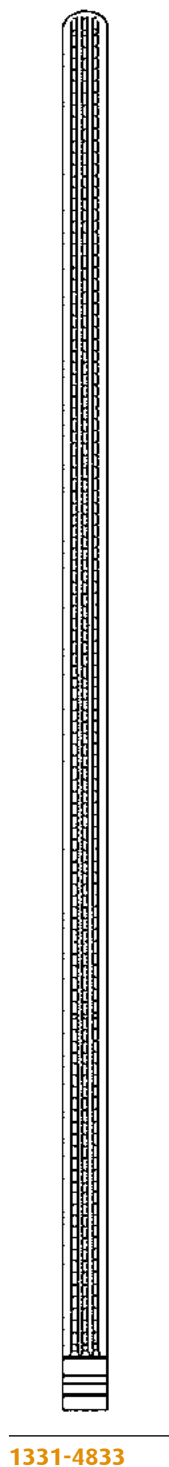

1331-4833

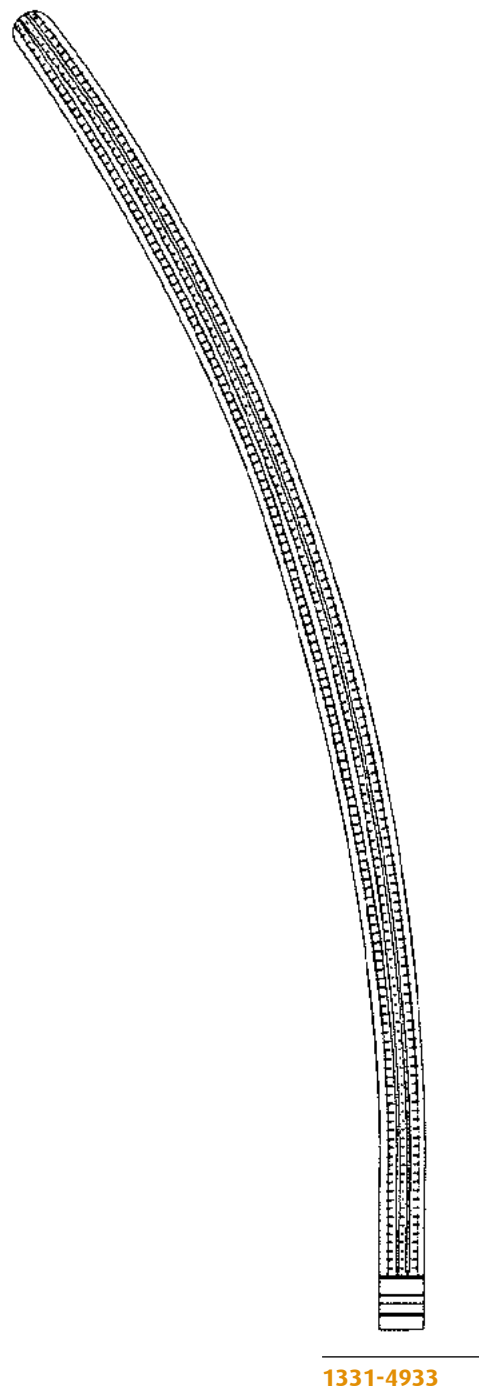

1331-4933

SCUDDER

1331-4833 - 1331-4933

33,0 cm / 13"

ATRAUMA



BRUNNER

1331-8524 24,0 cm / 9 1/2"

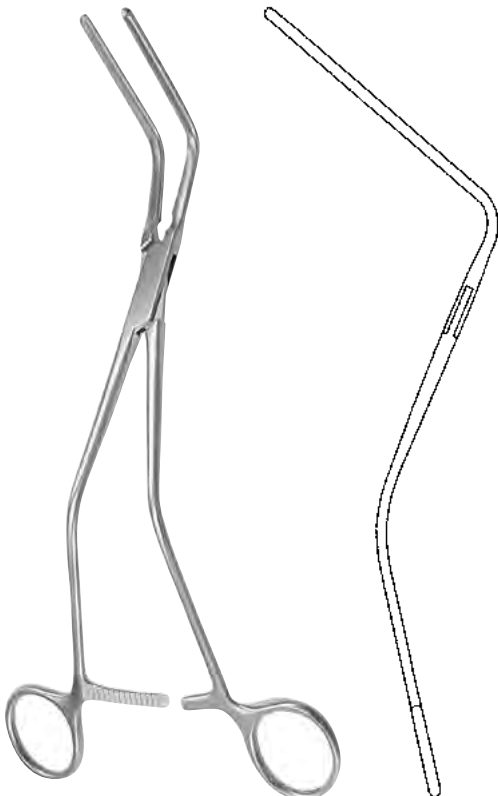

HAYES

1331-9126 - 1331-9128

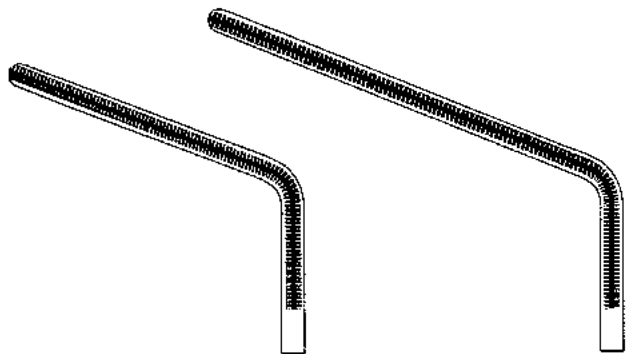

1331-9126 26,0 cm / 10"

1331-9128 28,0 cm / 11"

027

Rektum-Anastomosenklemmen
Sigmoid Anastomosis Forceps
Pinzas para anastomosis rectales
Pinze per anastomosi rettali

ATRAUMA

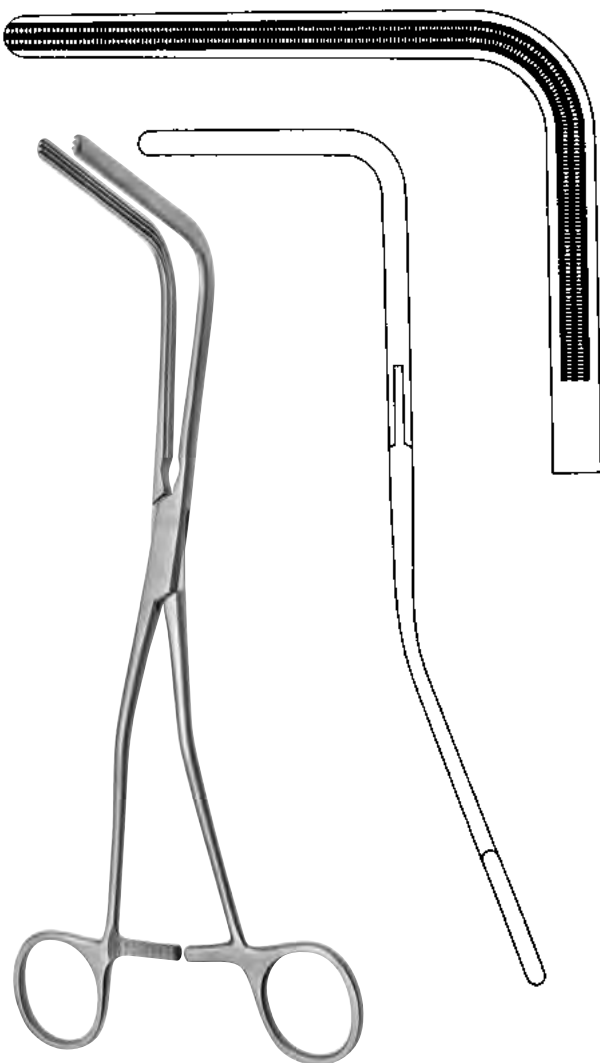

VEIDENHEIMER

1331-9125 25,0 cm / 9³/₄"



FEHLAND

1331-8709 24,0 cm / 9¹/₂"

Rektum-Anastomosenklemmen
Sigmoid Anastomosis Forceps
Pinzas para anastomoses rectales
Pinze per anastomosi rettali

027

ATRAUMA

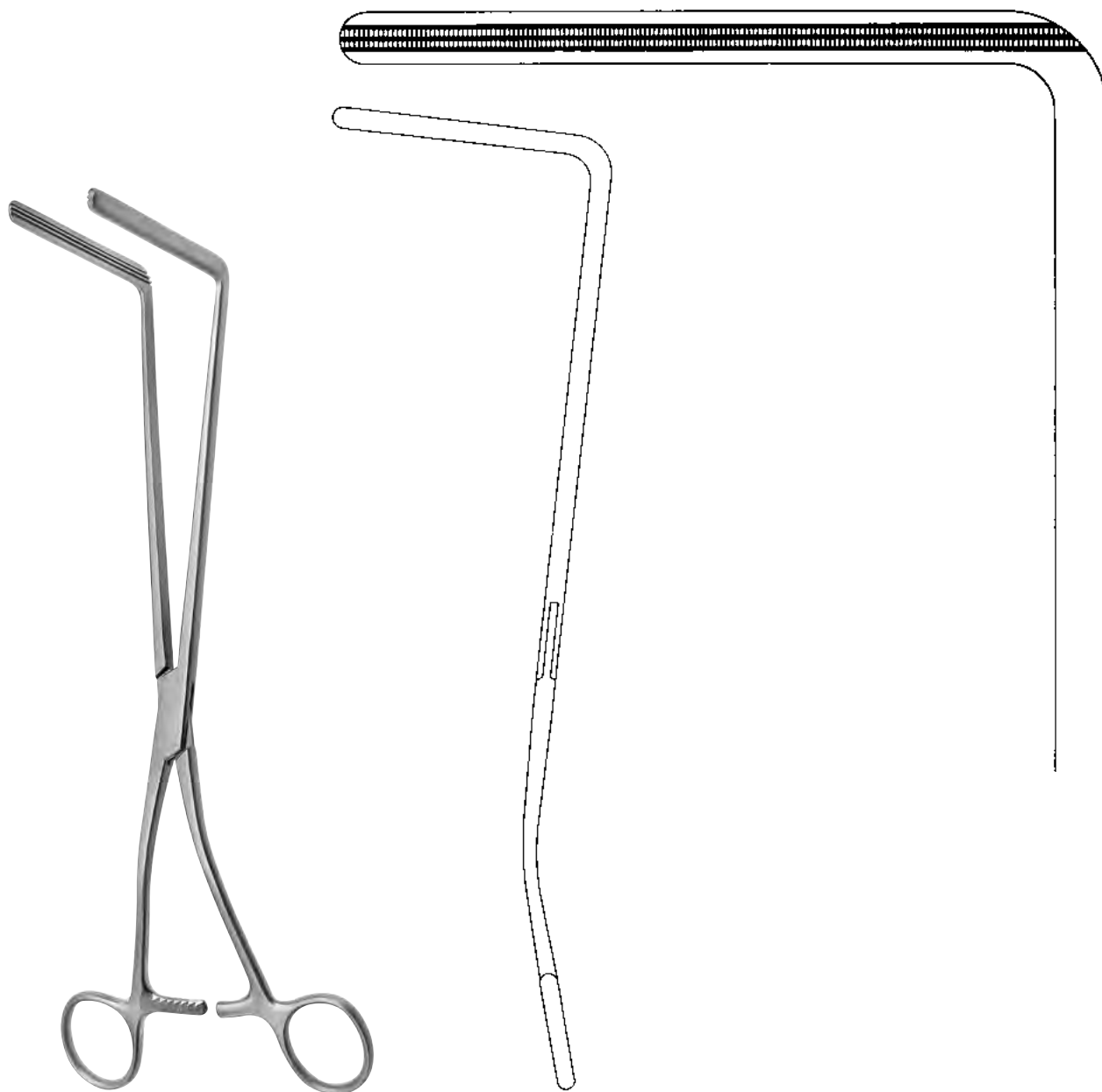

RESANO

1331-9426 30,0 cm / 11"

**CZERNY**

1333-0522 22,0 cm / 9 1/2"

**SIMS**

1333-0215 15,0 cm / 6"

**BODENHAMMER**

1333-0015 15,0 cm / 6"



PRATT

1333-0820 20,0 cm / 8"



70 x 22 mm

BARR

1333-0917 17,0 cm / 6³/₄"



MATHIEU

1333-1221 21,0 cm / 8 1/4"



SMITH BUIE

1333-2900 15,0 cm / 6"



SCHULZE-BERGMANN

1333-1019 - 1133-1025

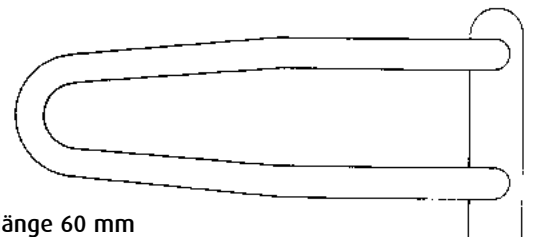

Valvenlänge 60 mm
 Length of Blades 60 mm
 Largo de valvas 60 mm
 Lunghezza di valvi 60 mm

1333-1019

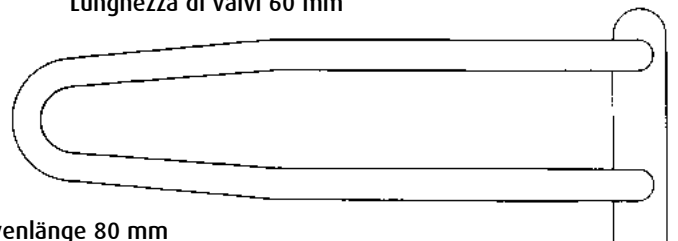

Valvenlänge 80 mm
 Length of Blades 80 mm
 Largo de valvas 80 mm
 Lunghezza di valvi 80 mm

1133-1023

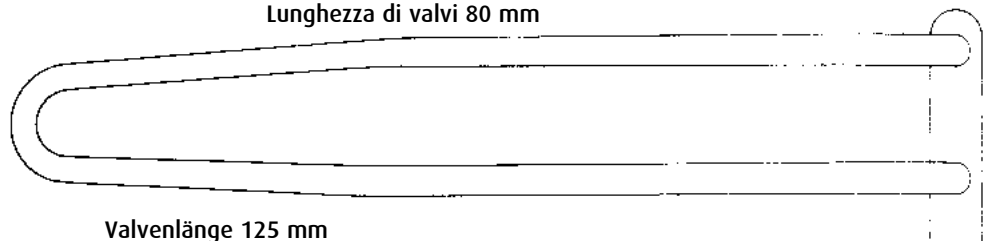

Valvenlänge 125 mm
 Length of Blades 125 mm
 Largo de valvas 125 mm
 Lunghezza di valvi 125 mm

1133-1025

Analspreizer, Sphinkteroskope, Anuskope
Rectal Retractor, Sphincteroscopes, Anoscopes
Separadores para el recto, Esfinteroscopios, Anoscopios
Dilatatori per l'ano e il retto, Sfinteroscopi, Anoscopi

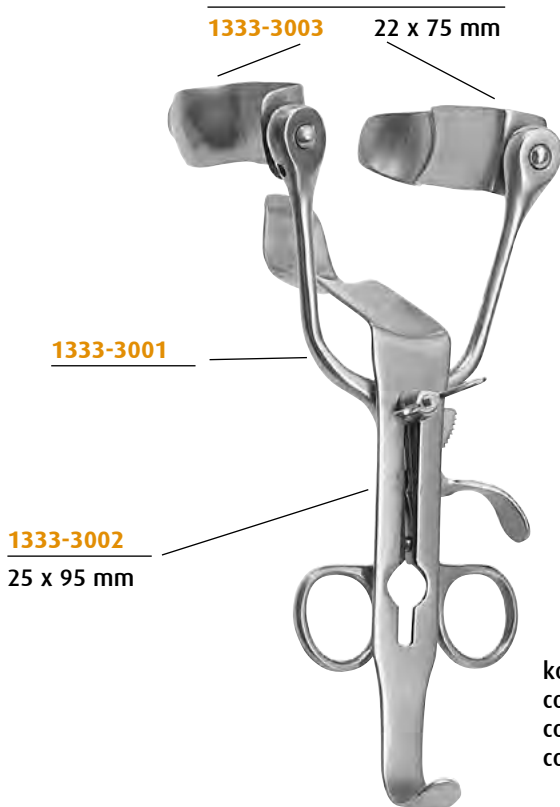

ALAN PARKS

1333-3050 13,5 cm / 5³/₈"
 komplett mit Kaltlichtträger
 complete with cold light carrier
 completo con portador para luz fria
 completo con supporto per luce fredda

komplett ohne Kaltlichtträger
 complete without cold light carrier
 completo sin portador para luz fria
 completo senza supporto per luce fredda

ALAN PARKS

1333-3000 13,5 cm / 5¹/₄"



1333-1623

Kunststoffobturator allein
 Obturator of plastic only
 Obturador de plastico suelto
 Otturatore di plastica solo

ohne Kaltlichtträger
 without cold light carrier
 sin portador para luz fria
 senza supporto per luce fredda

mit Kaltlichtträger
 with cold light carrier
 con portador para luz fria
 con supporto per luce fredda

IVES FANSLER

1333-1624 Ø 22 mm

IVES FANSLER

1333-1622 Ø 22 mm



HIRSCHMANN

1333-1701 Ø 16 x 65 mm
1333-1702 Ø 19 x 65 mm
1333-1703 Ø 22 x 70 mm

**KELLY**

1333-1821 Ø 21 x 50 mm
 1333-2027 Ø 27 x 50 mm

**FANSLER**

1333-1525 Ø 25 x 65 mm
 1333-1529 Ø 29 x 65 mm
 1333-1535 Ø 38 x 70 mm

**PRATT**

21,0 cm / 8 1/4"



1106-1701



1106-1702



1106-1703

Mastdarm-Biopsiezangen
Rectal Biopsy Forceps
Pinzas sacabocado para biopsia rectal
Pinze taglianti per biopsia rettale



YEOMAN

1333-6208 28,0 cm / 11"
1333-6215 35,0 cm / 13³/₄"
1333-6222 42,0 cm / 16¹/₂"

1333-6228 28,0 cm / 11"
1333-6235 35,0 cm / 13³/₄"
1333-6242 42,0 cm / 16¹/₂"



1333-6248 28,0 cm / 11"
1333-6255 35,0 cm / 13³/₄"
1333-6262 42,0 cm / 16¹/₂"

1333-6268 28,0 cm / 11"
1333-6275 35,0 cm / 13³/₄"
1333-6282 42,0 cm / 16¹/₂"

Haemorrhoiden-Ligator mit Ladekonus
Haemorrhoidal ligator with loading attachment
Ligador para hemorroides con cono de carga
Legatori emorroidali con carica a cono

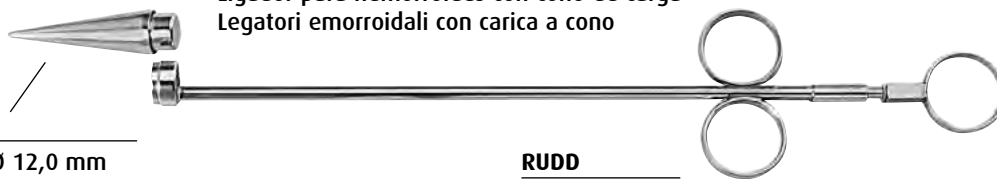

1333-5098 Ø 12,0 mm

RUDD

1333-5031

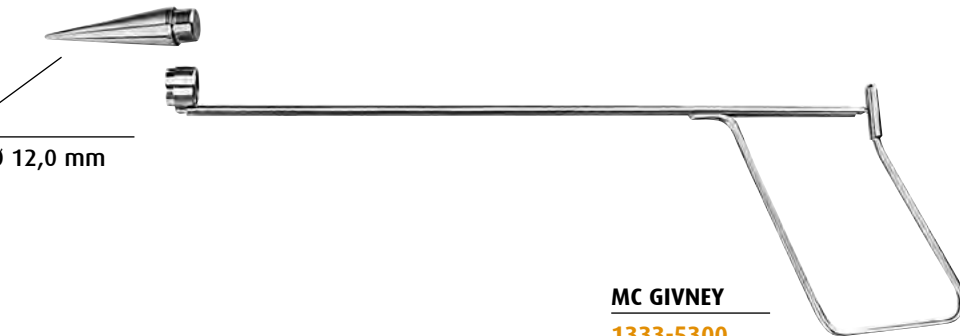

1333-5098 Ø 12,0 mm

MC GIVNEY

1333-5300

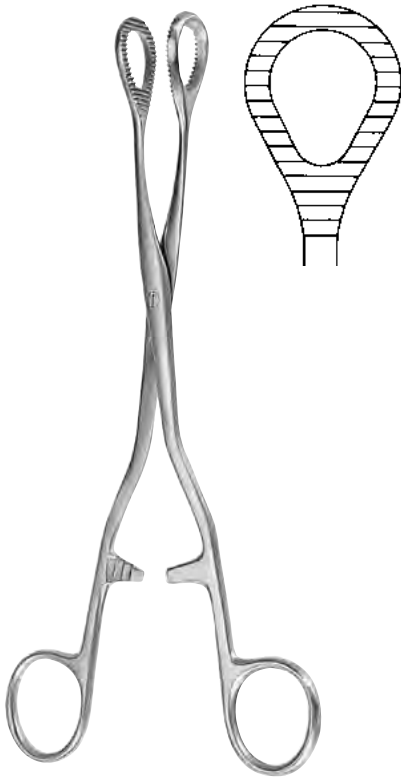

1333-5099
Gummiringe 100
Stück
Rubber rings 100 pieces
Anillos de goma 100 unidades
Anelli di gomma 100 pezzi

**HEYWOOD-SMITH**

1157-3022 21,0 cm / 8¹/₄"
1157-2825 25,0 cm / 9³/₄"

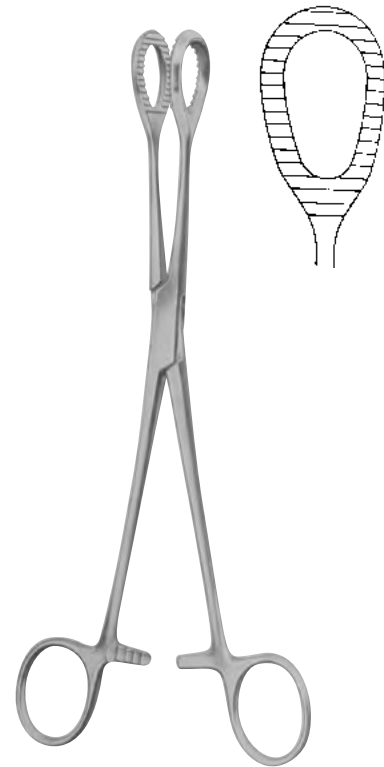
**HEYWOOD-SMITH**

1157-3021 21,0 cm / 8¹/₄"
1157-3020 25,0 cm / 9³/₄"

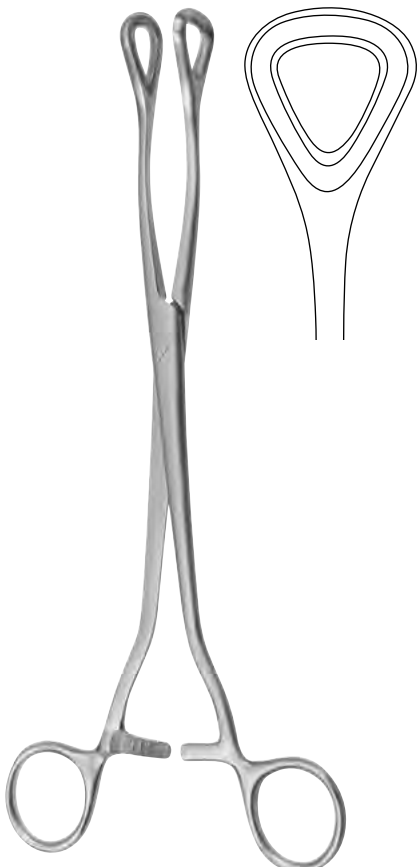
**LUER**

1157-8824 24,5 cm / 9²/₃"

**MC GIVNEY**

1333-5219 19,0 cm / 7¹/₂"

**MC GIVNEY**

1333-5218 19,0 cm / 7¹/₂"

Nierensteinzangen
Kidney Stone Forceps
Pinzas para los cálculos renales
Pinze per calcoli renali

027

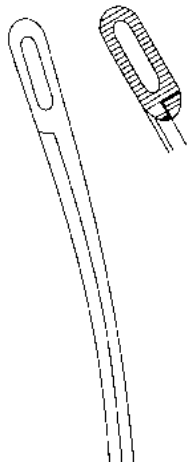

1342-0701 23,0 cm / 9"

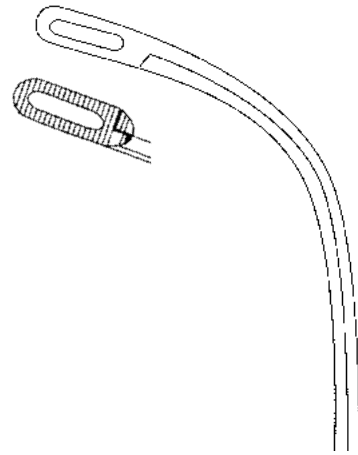

1342-0702 22,0 cm / 8⁵/₈"



RANDALL

1342-0701 - 1342-0704

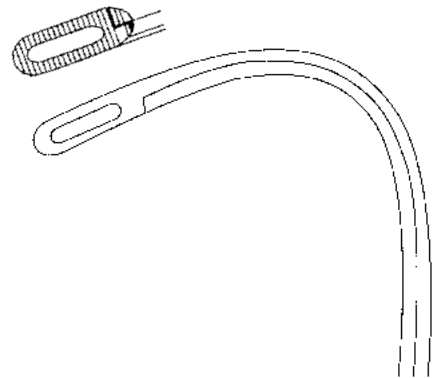

1342-0703 19,0 cm / 7¹/₂"

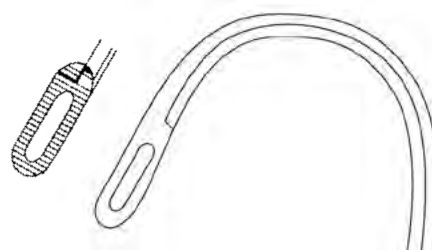

1342-0704 19,0 cm / 7¹/₂"

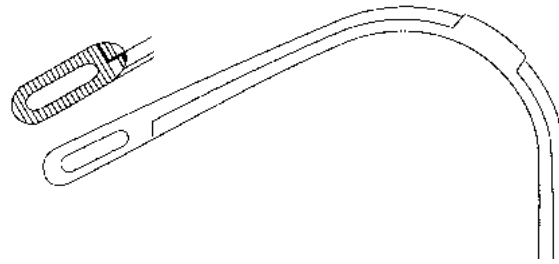

1342-0905

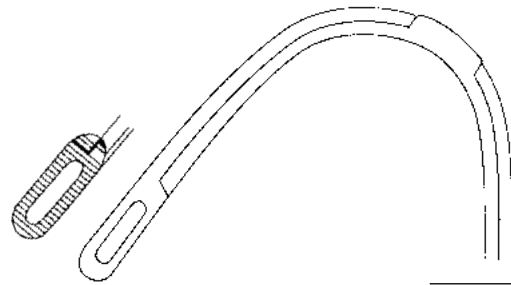

1342-0906

RANDALL

1342-0905 - 1342-0906

19,0 cm / 7 1/2"

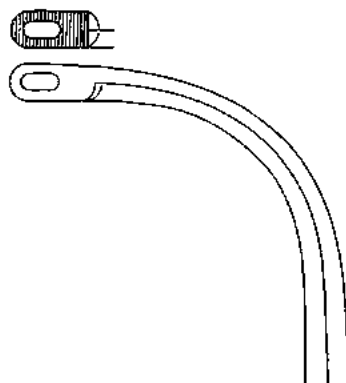

1342-0116 16,0 cm / 6 1/4"



1342-0117 17,0 cm / 6 3/4"

HEIMING

1342-0116 - 1342-0117

Nierenfistelzangen
Nephrostomy Forceps
Pinzas para nefrostomía
Pinze per nefrostomia

027

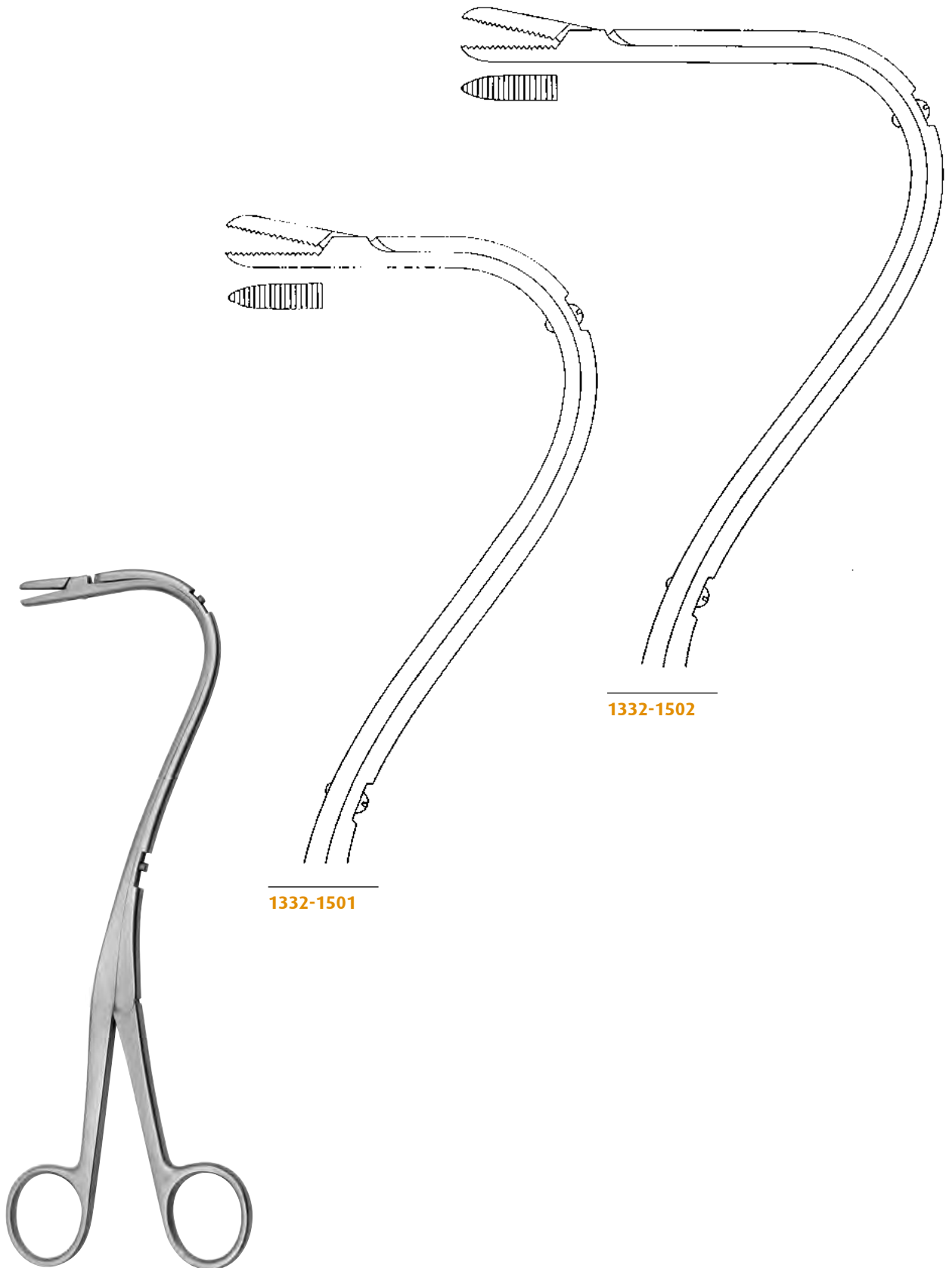

ELSÄSSER

1332-1501 - 1332-1502

21,0 cm / 8¹/₄"



1341-0201 Ø 1,0 mm



1341-0202 Ø 2,0 mm



1341-0203 Ø 3,0 mm



1341-0204 Ø 4,0 mm



1341-0205 Ø 5,0 mm



1341-0206 Ø 6,0 mm



1341-0207 Ø 7,0 mm



1341-0208 Ø 8,0 mm



1341-0209 Ø 9,0 mm



1341-0210 Ø 10,0 mm



1341-0211 Ø 11,0 mm



1341-0212 Ø 12,0 mm

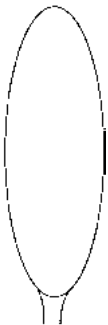

1341-0213 Ø 13,0 mm



biegsamer Schaft
malleable shaft
vastago maleable
asta malleabile

1341-0199

Satz à 9 Stück ø 3,0 -11,0 mm
set of 9 pieces ø 3,0 -11,0 mm
juego de 9 piezas ø 3,0 -11,0 mm
set di 9 pezzi ø 3,0 -11,0 mm

BAKES

1341-0201 - 1341-0213

30,0 cm / 11³/₄"

Gallensteinlöffel, Gallengangsonden

Gall Stone Scoops, Gall Duct Probes

Cucharilla para los cálculos biliares, sondas para el conducto biliar

Cucchiai per calcoli biliari, Dilatatori per condotti biliari

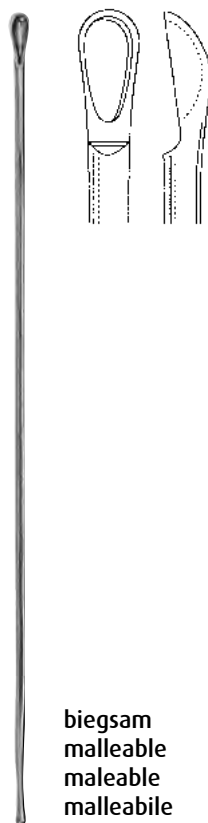

biegsam
malleable
maleable
malleabile

MOYNIHAN

1341-0536 34,0 cm / 13³/₄"



1341-0401 13 Charr.

1341-0402 18 Charr.



1341-0403 21 Charr.

federnd
flexible
flexible
flessibile

DESJARDINS

1341-0401 - 1341-0403 28,0 cm / 11"



biegsam
malleable
maleable
malleabile

MAYO

1341-0533 32,0 cm / 12¹/₂"



CZERNY

1341-0624 24,5 cm / 9⁵/₈"



TURNER-WARWICK

1341-0718 18,0 cm / 7"
1341-0719 19,0 cm / 7¹/₂"

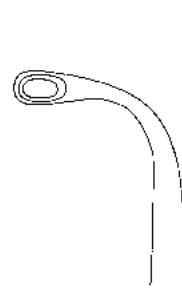

1341-0718

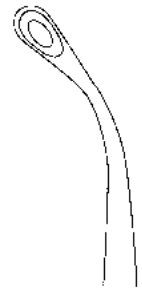

1341-0719



BLAKE

1342-4420 - 1342-4419 20,0 cm / 8"



1342-4419



MAYO-BLAKE

1342-4520 - 1342-4519 20,0 cm / 8"



1342-4519

Gallensteinzangen, Gallensteinlöffel
Gall Stone Forceps, Gall Stone Scoops
Pinzas para cálculos biliares, Cucharas para cálculos biliares
Pinze per calcoli biliari, Cucchiai per calcoli biliari

027



MIXTER

1342-4722 22,0 cm / 8³/₄"

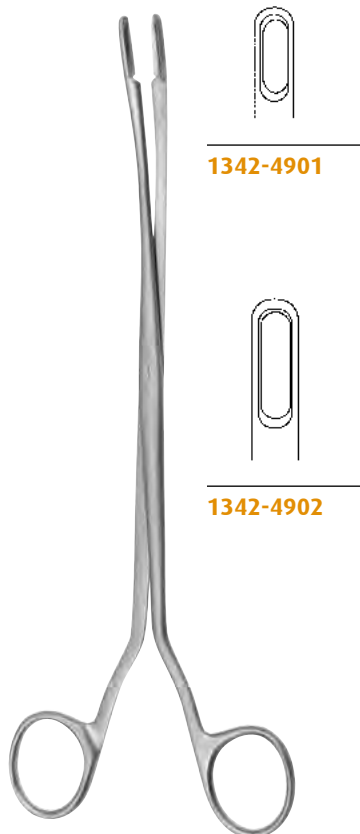

DESJARDINS

1342-4901 - 1342-4902 23,0 cm / 9"



STILLE

1342-5324 24,5 cm / 9²/₃"

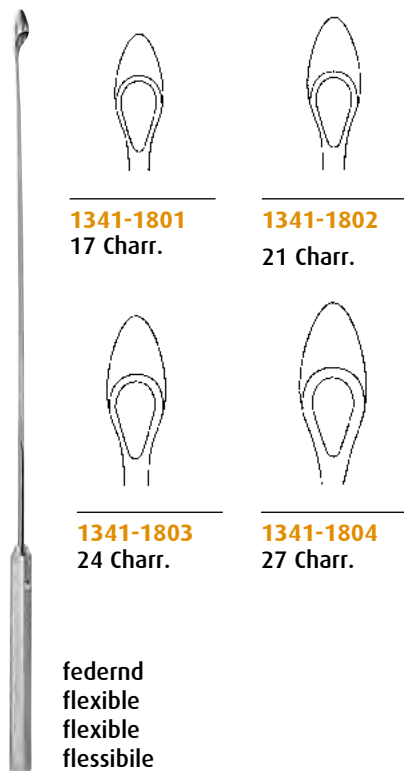

DESJARDINS

1341-1801 - 1341-1804 30,0 cm / 11³/₄"

federnd
flexible
flexible
flessibile

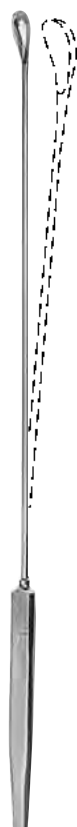

LUER-KÖRTE

1341-2001 - 1341-2008 32,0 cm / 12¹/₂"

Fig. 000

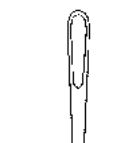

1341-2001
ø 2,5 mm

Fig. 00



1341-2002
ø 3,2 mm

Fig. 0



1341-2003
ø 4,2 mm

Fig. 1



1341-2004
ø 5,5 mm

Fig. 2



1341-2005
ø 6,7 mm

Fig. 3



1341-2006
ø 8,0 mm

Fig. 4



1341-2007
ø 11,0 mm

Fig. 5



1341-2008
ø 15,0 mm

biegsamer Schaft
malleable shaft
vastago maleable
asta malleabile



Gallenblasenlöffel
 Gall bladder scoope
 Cucharilla para la vesicula biliar
 Cucchiaio pre colecisti

MOORE

1341-3028 30,0 cm / 12"

**MAYO**

1341-3228 28,0 cm / 11"

**FERGUSSON**

1341-3401 21,5 cm / 8 1/2"

Prostatahaken, Blasenspatel
Prostatic Retractors, Bladder Retractor
Separadores para la prostata, Separadores vesicales
Retrattori prostatici, Divaricatori vescicali

027



YOUNG

1366-2301 21,0 cm / 8¹/₄"



YOUNG

1366-2302 22,0 cm / 8⁵/₈"



YOUNG

1366-2303 21,0 cm / 8¹/₄"

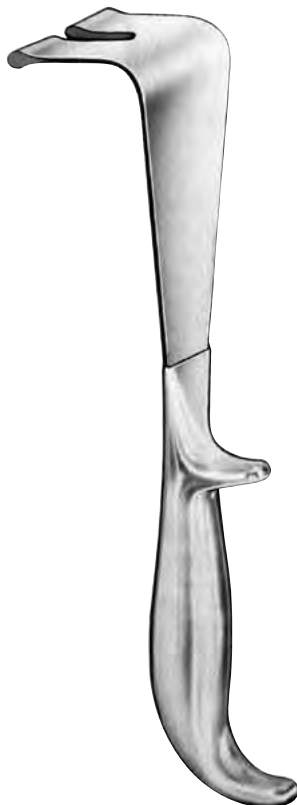

YOUNG

1366-2304 22,0 cm / 8⁵/₈"



YOUNG

1366-2305 20,0 cm / 8"

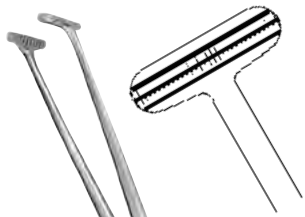

ATRAUMA



MILLIN

1366-5124 24,0 cm / 9 1/2"



ATRAUMA



MILLIN

1366-5125 24,0 cm / 9 1/2"

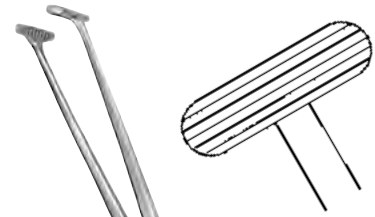

MILLIN

1366-5523 24,0 cm / 9 1/2"

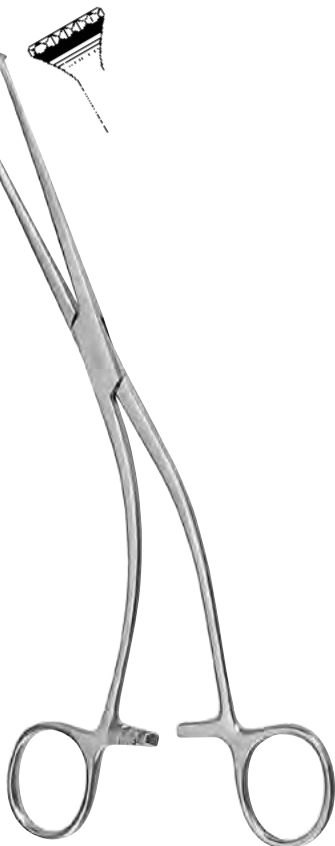

MILLIN

1366-5723 23,0 cm / 9"

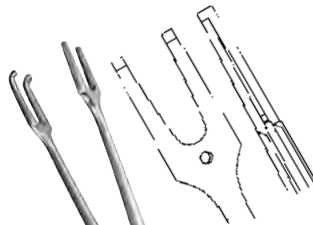

MILLIN

1366-5924 24,0 cm / 9 1/2"



MILLIN

1366-2200 28,5 cm / 11 1/4"

Blasenwundspreizer
Bladder Retractors
Separadores para la vejiga
Divaricatori vescicali

JUDD-MASSON

1366-1901

ohne Mittelblatt
 without central blade
 sin valva central
 senza valva centrale

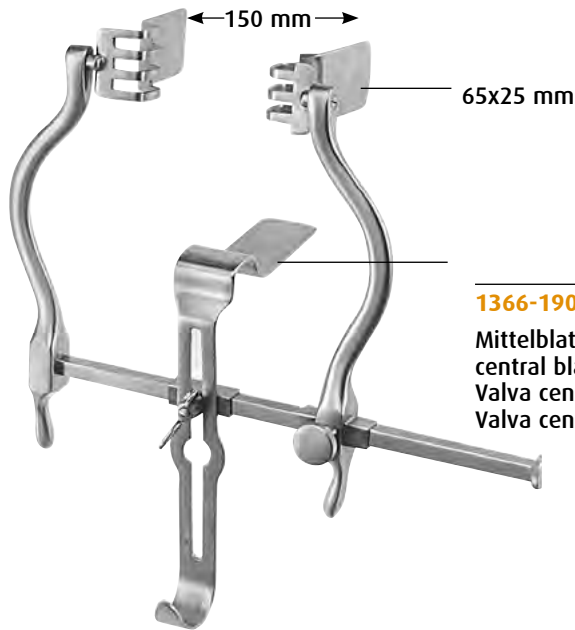

1366-1902

75x25 mm

Mittelblatt
 central blade
 Valva central
 Valva centrale

JUDD-MASSON

1366-1900

mit Mittelblatt
 with central blade
 con valva central
 con valva centrale

JUDD-MASSON

1366-2004

Seitenvalven
 lateral blades
 Valvas laterales
 Valva laterale

1366-2003

Seitenvalven
 lateral blades
 Valvas laterales
 Valva laterale

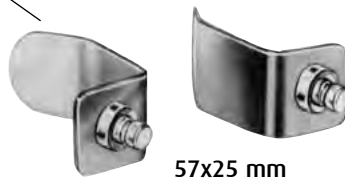

80x25 mm

57x25 mm

120x45 mm

1366-2001

Rahmen allein
 Frame only
 Cuadro suelto
 telaio solo

1366-2002

Mittelblatt
 central blade
 Valva central
 Valva centrale

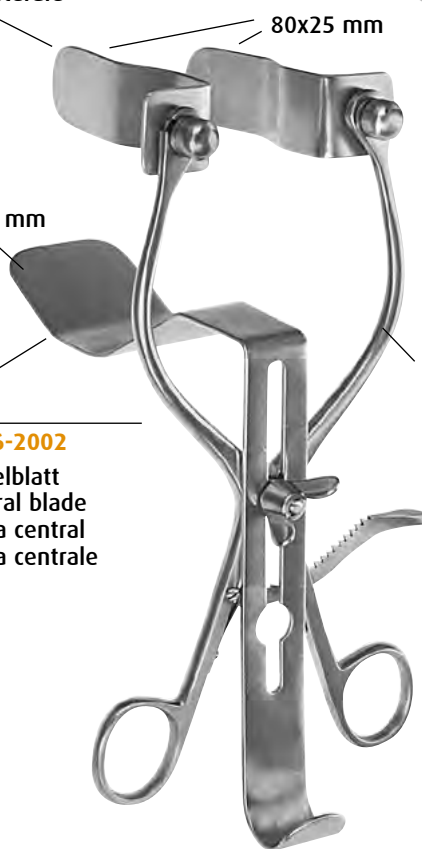

120x45 mm

80x25 mm

MILLIN

1366-2000

1366-2011

Kaltlichtaufsatz
 cold light carrier
 portador para luz fria
 supporto per luce fredda

MILLIN

1366-2010



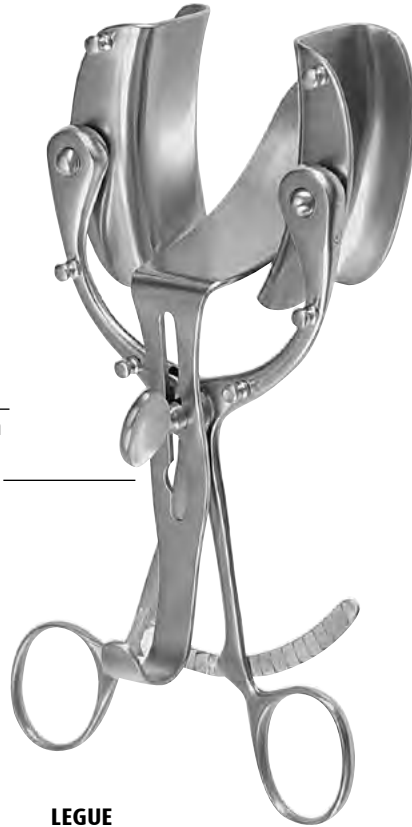

1366-1701 28 x 60 mm
 Seitenvlaven
 lateral blades
 Valvas laterales
 Valva laterale

1366-1702 70 x 32 mm
 Mittelvalve
 center blade
 Valva central
 Valva centrale

LEGUE

1366-1700



35 mm

LEGUEU

1366-2127 30,0 cm / 11¹/₄"



67 mm

KOCHER

1366-2526 27,0 cm / 10³/₄"

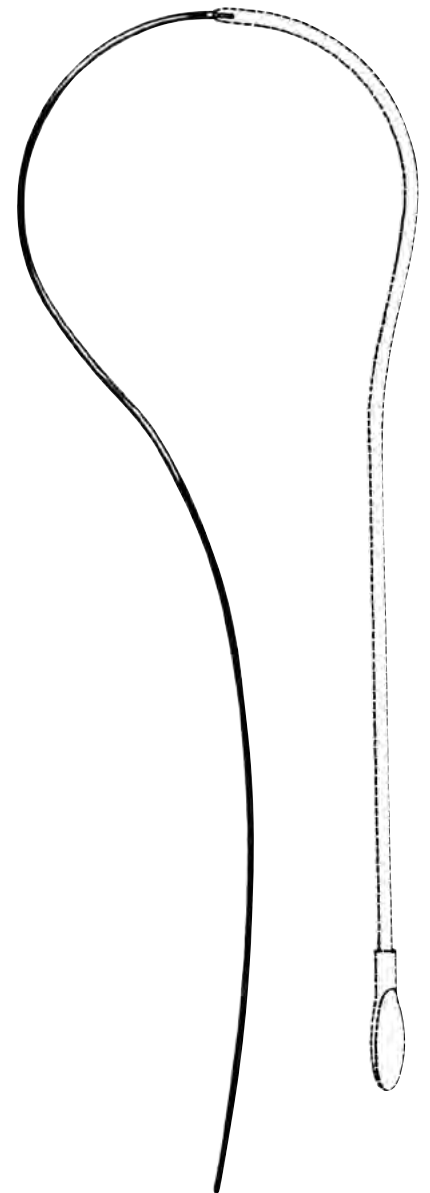
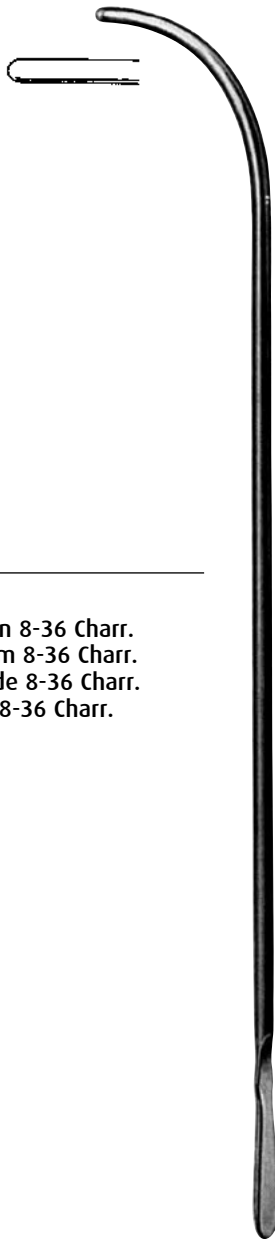

1361-0200

Satz komplett von 8-36 Charr.
Set complete from 8-36 Charr.
Juego completo de 8-36 Charr.
Set completo da 8-36 Charr.

VAN BUREN

1361-0208	Ø 2 ² / ₃ mm	Char. 8
1361-0210	Ø 3 ¹ / ₃ mm	Char. 10
1361-0212	Ø 4 mm	Char. 12
1361-0214	Ø 4 ² / ₃ mm	Char. 14
1361-0216	Ø 5 ¹ / ₃ mm	Char. 16
1361-0218	Ø 6 mm	Char. 18
1361-0220	Ø 6 ² / ₃ mm	Char. 20
1361-0222	Ø 7 ¹ / ₃ mm	Char. 22
1361-0224	Ø 8 mm	Char. 24
1361-0226	Ø 8 ² / ₃ mm	Char. 26
1361-0228	Ø 9 ¹ / ₃ mm	Char. 28
1361-0230	Ø 10 mm	Char. 30
1361-0232	Ø 10 ² / ₃ mm	Char. 32
1361-0234	Ø 11 ¹ / ₃ mm	Char. 34
1361-0236	Ø 12 mm	Char. 36

GUYON

1361-0012	Ø 4 mm	Char. 12
1361-0013	Ø 4 ¹ / ₃ mm	Char. 13
1361-0014	Ø 4 ² / ₃ mm	Char. 14
1361-0015	Ø 5 mm	Char. 15
1361-0016	Ø 5 ¹ / ₃ mm	Char. 16
1361-0017	Ø 5 ² / ₃ mm	Char. 17
1361-0018	Ø 6 mm	Char. 18
1361-0019	Ø 6 ¹ / ₃ mm	Char. 19
1361-0020	Ø 6 ² / ₃ mm	Char. 20
1361-0021	Ø 7 mm	Char. 21
1361-0022	Ø 7 ¹ / ₃ mm	Char. 22
1361-0023	Ø 7 ² / ₃ mm	Char. 23
1361-0024	Ø 8 mm	Char. 24
1361-0025	Ø 8 ¹ / ₃ mm	Char. 25
1361-0026	Ø 8 ² / ₃ mm	Char. 26
1361-0027	Ø 9 mm	Char. 27
1361-0028	Ø 9 ¹ / ₃ mm	Char. 28
1361-0029	Ø 9 ² / ₃ mm	Char. 29
1361-0030	Ø 10 mm	Char. 30

FILIFORM

1361-0103	Char. 3
1361-0104	Char. 4
1361-0105	Char. 5
1361-0106	Char. 6



für Männer
for male
para hombres
per uomini

27,0 cm / 10³/₄"

1361-1208	Char. 8	ø 2 ² / ₃ mm
1361-1210	Char. 10	ø 3 ¹ / ₃ mm
1361-1212	Char. 12	ø 4 mm
1361-1214	Char. 14	ø 4 ² / ₃ mm
1361-1216	Char. 16	ø 5 ¹ / ₃ mm
1361-1218	Char. 18	ø 6 mm
1361-1220	Char. 20	ø 6 ² / ₃ mm
1361-1222	Char. 22	ø 7 ¹ / ₃ mm
1361-1224	Char. 24	ø 8 mm



für Frauen
for female
para mujeres
per donne

15,0 cm / 6"

1361-1006	Char. 6	ø 2 mm
1361-1007	Char. 7	ø 2 ¹ / ₃ mm
1361-1009	Char. 8	ø 2 ² / ₃ mm
1361-1009	Char. 9	ø 3 mm
1361-1010	Char. 10	ø 3 ¹ / ₃ mm
1361-1011	Char. 11	ø 3 ² / ₃ mm
1361-1012	Char. 12	ø 4 mm
1361-1013	Char. 13	ø 4 ¹ / ₃ mm
1361-1014	Char. 14	ø 4 ² / ₃ mm
1361-1015	Char. 15	ø 5 mm
1361-1016	Char. 16	ø 5 ¹ / ₃ mm
1361-1018	Char. 18	ø 6 mm
1361-1020	Char. 20	ø 6 ² / ₃ mm
1361-1022	Char. 22	ø 7 ¹ / ₃ mm
1361-1024	Char. 24	ø 8 mm



OTIS

1366-3000

komplett im Holzetui
mit dilatator, 2 Messer und 3 Ansätzen
complete in wooden case
with dilator, 2 knives 3 tips
completo en caja de madera
con dilatador, 2 cuchillos y 3 puntas
completo in contenitore di legno
con dilatatore, 2 coltelli e 3
punte



OTIS

1366-3001

Ersatzmesser
Replacement knife
cuchillo de repuesto
Coltello di ricambio



**COMCO**

1367-6508	ø 8,0 mm
1367-6511	ø 11,0 mm
1367-6513	ø 13,0 mm
1367-6516	ø 16,0 mm
1367-6521	ø 21,0 mm
1367-6525	ø 26,0 mm
1367-6532	ø 32,0 mm

**KNUTSON-KOCH****1367-6631**

Konus
 Cone
 Cono
 Cono

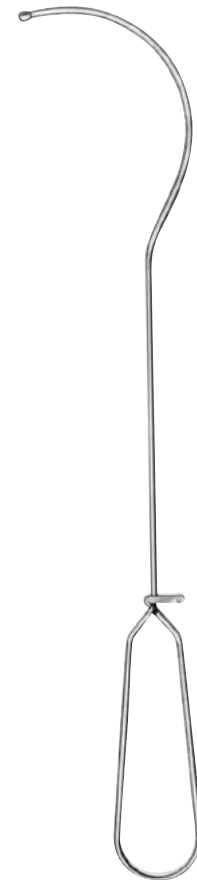
KNUTSON**1367-6630****MOGEN****1367-6675** 7,5 cm / 3"**GUYON****1360-7039** 39,0 cm / 16"**GUYON****1360-7135** 35,0 cm / 13³/₄"

Penisklemmen, Fremdkörperzange
Penis Clamp, Foreign Body Forceps
Compresor urétral, Pinzas para cuerpos extraños
Serrapene, Pinze per corpi estranei

027



STRAUSS

1360-6011 11,0 cm / 4¹/₃"



STOCKMANN

1360-5008 8,0 cm / 3¹/₄"



MATHIEU

1360-8019 20,0 cm / 8"
1360-8028 28,0 cm / 11"

030

**Gynäkologie, Geburtshilfe
Gynecology, Obstetrics
Ginecología, Ostetricia
Ginecologia, Ostetricia**



für Jungfrauen
for virgins
para virgenes
per vergini



Schweizer Modell
Swiss pattern
Modelo suizo
Modello svizzero

CUSCO

1350-0701	80x22 mm
1350-0702	100x25 mm
1350-0703	105x27 mm

seitliche Stellschraube
lateral fixation screw
tornillo de sujeto lateral
vite di regolazione laterale



CUSCO

1350-0301	75x17 mm
-----------	----------



zentrale Stellschraube
central fixation screw
tornillo de sujeto central
vite di regolazione centrale

CUSCO

1350-0601	75x32 mm
1350-0602	85x35 mm
1350-0603	100x37 mm



seitliche Stellschraube
lateral fixation screw
tornillo de sujeto lateral
vite di regolazione laterale

CUSCO

1350-0711	75x32 mm
1350-0712	85x35 mm
1350-0713	100x35 mm



CUSCO STANDARD

1350-0500	80x24 mm
1350-0501	80x32 mm
1350-0502	85x36 mm
1350-0503	110x37 mm



für Kinder
 for children
 para niñas
 per bambini

COLLIN

1350-0001	55x10 mm
-----------	----------



COLLIN

1350-0103	55x10 mm
1350-0101	65x20 mm

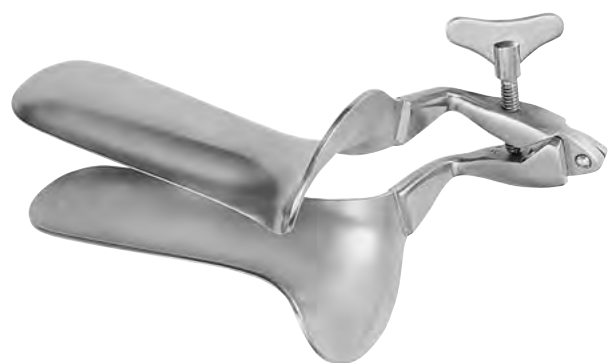

COLLIN

1350-0201	85x30 mm
1350-0202	100x35 mm
1350-0203	110x40 mm

**GRAVE**

1350-1301	75x20 mm
1350-1302	95x35 mm
1350-1303	115x35 mm

**PEDERSON**

1350-1401	75x13 mm
1350-1402	100x22 mm
1350-1403	120x25 mm

**SEMM**

1350-0801	90x14-18 mm
1350-0802	100x17-20 mm
1350-0803	100x25-30 mm

**SEYFFERT**

1350-0901	100x17 mm	Fig.1
1350-0902	110x33 mm	Fig.2



TRELAT

1350-1001	85x33 mm	Fig.1
1350-1002	95x35 mm	Fig.2
1350-1003	115x43 mm	Fig.3

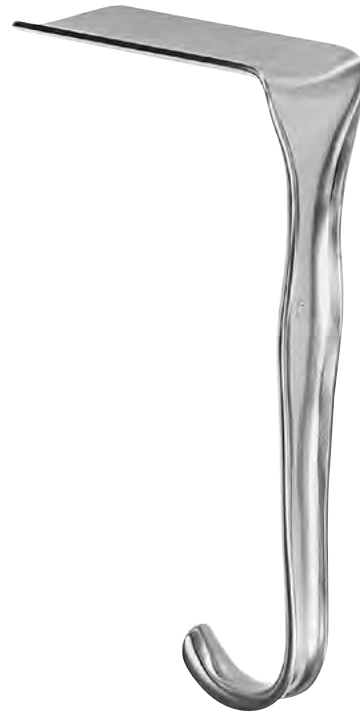

JACKSON

1350-8501	75x35 mm	Fig.1
1350-8502	90x35 mm	Fig.2
1350-8503	100x35 mm	Fig.3

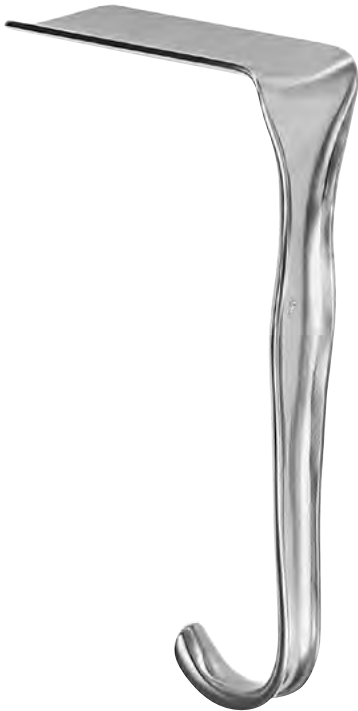

JACKSON

1350-8575	75x40 mm	Fig.1
1350-8590	90x40 mm	Fig.2
1350-8599	100x40 mm	Fig.3



EASTMAN

1350-7501	75x35 mm	Fig.1
1350-7502	90x35 mm	Fig.2
1350-7503	100x35 mm	Fig.3



EASTMAN

1350-7601	75x40 mm	Fig.1
1350-7602	90x40 mm	Fig.2
1350-7603	100x40 mm	Fig.3



SIMS
1350-1900

Satz
Set
Juego
Set



60x30 mm

60x25 mm

SIMS
1350-1901 12,5 cm / 5"



70x35 mm

70x30 mm

SIMS
1350-1902 15,0 cm / 6"



80x40 mm

80x35 mm

SIMS
1350-1903 17,5 cm / 7"



SIMS
1350-1801 Fig.1 70x25 mm
1350-1802 Fig.2 85x30 mm
1350-1803 Fig.3 100x40 mm

Scheidenspekula
Vaginal Specula
Espéculos vaginales
Specoli vaginali

030



KRISTELLER

1350-3101	70x27 mm
1350-3102	75x30 mm
1350-3103	90x36 mm



KRISTELLER

1350-3201	75x23 mm
1350-3202	80x26 mm
1350-3203	95x32 mm



KRISTELLER

	Satz/Set/juego/set
1350-3001	70x27 mm + 75x23 mm
1350-3002	75x30 mm + 80x26 mm
1350-3003	90x36 mm + 95x32 mm



tiefes Spekulum
deep speculum
espéculo profundo
Specolo profondo

KRISTELLER

1350-5101	110x27 mm
1350-5102	110x30 mm
1350-5103	110x36 mm



KRISTELLER

1350-5201	115x23 mm
1350-5202	115x26 mm
1350-5203	115x32 mm



KRISTELLER

	Satz/Set/juego/set
1350-5001	110x27 mm + 115x23 mm
1350-5002	110x30 mm + 115x26 mm
1350-5003	110x36 mm + 115x32 mm

flaches Spekulum
flat speculum
espéculo plano
specolo piatto

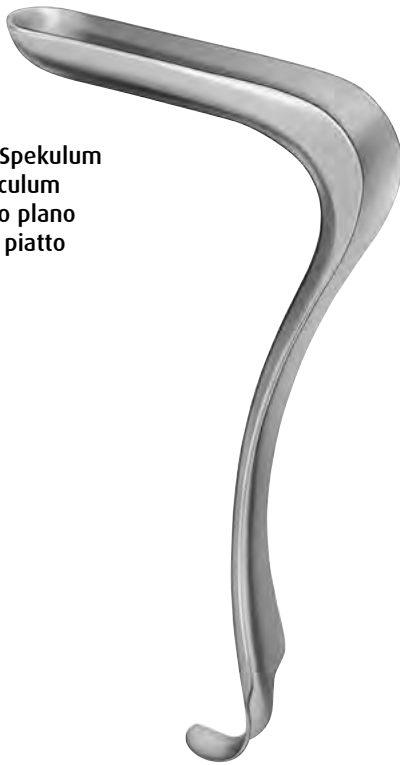

KRISTELLER

1350-6101	110x27 mm
1350-6102	110x30 mm
1350-6103	110x36 mm



KRISTELLER

1350-6201	115x23 mm
1350-6202	115x26 mm
1350-6203	115x32 mm



KRISTELLER

	Satz/Set/juego/set
1350-6001	110x27 mm + 115x23 mm
1350-6002	110x30 mm + 115x26 mm
1350-6003	110x36 mm + 115x32 mm



KRISTELLER

1350-4101 110x18 mm
1350-4102 110x21 mm



KRISTELLER

1350-4201 115x14 mm
1350-4202 115x17 mm



KRISTELLER Satz/Set/juego/set

1350-4001 110x18 mm + 115x14 mm
1350-4002 110x21 mm + 115x17 mm



KRISTELLER
1350-3301 130x40 mm



KRISTELLER
1350-3401 135x36 mm



KRISTELLER Satz/Set/juego/set
1350-6301 130x40 mm + 135x36 mm



KRISTELLER
1350-3100 70x15 mm



KRISTELLER
1350-3200 75x10 mm



KRISTELLER Satz/Set/juego/Set
1350-3000 70x15 mm + 75x10 mm

**KALLMORGEN**

1350-7011 70x40 mm
1350-7012 90x40 mm

**KALLMORGEN**

1350-7021 70x33 mm
1350-7022 90x33 mm

**KALLMORGEN**

Satz/Set/juego/set

1350-7001 70x40 mm + 70x33 mm
1350-7002 90x40 mm + 90x33 mm



Spekulum allein
Speculum only
Espèculo suelto
Specolo solo

MATHIEU

1350-8003 95x16-26 mm
1350-8001 95x16-30 mm



Halter allein
Retractor only
Valva suelta
Valva sola

MATHIEU

1350-8004 100x11/21 mm
1350-8002 100x14/27 mm

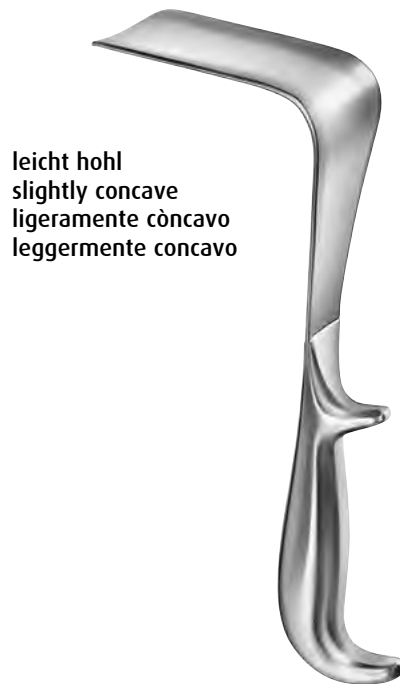

leicht hohl
slightly concave
ligeramente còncavo
leggermente concavo

DOYEN

1350-8201	55x35	mm	Fig.1	24,0 cm / 9 ¹ / ₂ "
1350-8202	85x35	mm	Fig.2	24,0 cm / 9 ¹ / ₂ "
1350-8203	115x35	mm	Fig.3	24,0 cm / 9 ¹ / ₂ "
1350-8301	55x45	mm	Fig.1	24,0 cm / 9 ¹ / ₂ "
1350-8302	85x45	mm	Fig.2	24,0 cm / 9 ¹ / ₂ "
1350-8303	115x45	mm	Fig.3	24,0 cm / 9 ¹ / ₂ "
1350-8304	160x45	mm	Fig.4	24,0 cm / 9 ¹ / ₂ "
1350-8401	55x60	mm	Fig.1	24,0 cm / 9 ¹ / ₂ "
1350-8402	85x60	mm	Fig.2	24,0 cm / 9 ¹ / ₂ "
1350-8403	115x60	mm	Fig.3	24,0 cm / 9 ¹ / ₂ "
1350-8404	160x60	mm	Fig.4	24,0 cm / 9 ¹ / ₂ "

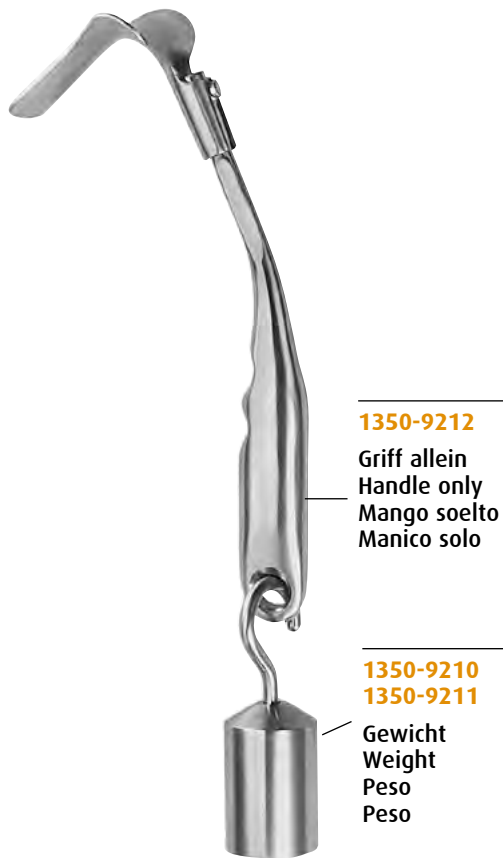

1350-9212
Griff allein
Handle only
Mango soelto
Manico solo

1350-9210 400g
1350-9211 800g

Gewicht
Weight
Peso
Peso

SCHERBAK

1350-9100

komplett
complete
completo
completo



Fig. 1

1350-9201 80x30 mm

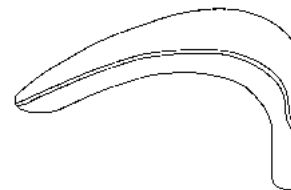

Fig. 2

1350-9202 85x35 mm



Fig. 3

1350-9203 90x40 mm

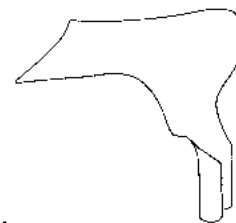

Fig. 4

1350-9204 55x40/60 mm



Fig. 5

1350-9205 70x45/70 mm

mit festem Gewicht
with fixed weight
con peso fijo
con peso fisso



AUVARD
1350-9300 90x45 mm

mit abnehmbarem Gewicht
with detachable weight
con peso desmontable
con peso smontabile



AUVARD
1350-9301 80x38 mm

80x42 mm

mit abnehmbarem Auffangsieb
with removable strainer
con tamiz desmontable
con filtro smontabile



WEISSBARTH
1350-9400 21,0 cm / 8¹/₄"

**BREISKY**

1350-8720	100x20 mm	30,0 cm / 12"
1350-8725	100x25 mm	30,0 cm / 12"
1350-8730	100x30 mm	30,0 cm / 12"
1350-8735	100x35 mm	30,0 cm / 12"
1350-8740	100x40 mm	30,0 cm / 12"
1350-8820	130x20 mm	32,0 cm / 12 ³ / ₄ "
1350-8825	130x25 mm	32,0 cm / 12 ³ / ₄ "
1350-8830	130x30 mm	32,0 cm / 12 ³ / ₄ "
1350-8835	130x35 mm	32,0 cm / 12 ³ / ₄ "
1350-8840	130x40 mm	32,0 cm / 12 ³ / ₄ "
1350-8940	155x40 mm	35,0 cm / 14"

LANDAU

1350-8629	100x28 mm	29,0 cm / 11 ¹ / ₂ "
1350-8638	100x38 mm	29,0 cm / 11 ¹ / ₂ "

DOYEN

1350-8170	25,0 cm / 9"
------------------	--------------



HEGAR

1351-0001	Ø 1,0 mm	18,5 cm / 7 ¹ / ₄ "
1351-0002	Ø 2,0 mm	18,5 cm / 7 ¹ / ₄ "
1351-0003	Ø 3,0 mm	18,5 cm / 7 ¹ / ₄ "
1351-0004	Ø 4,0 mm	18,5 cm / 7 ¹ / ₄ "
1351-0005	Ø 5,0 mm	18,5 cm / 7 ¹ / ₄ "
1351-0006	Ø 6,0 mm	18,5 cm / 7 ¹ / ₄ "
1351-0007	Ø 7,0 mm	18,5 cm / 7 ¹ / ₄ "
1351-0008	Ø 8,0 mm	18,5 cm / 7 ¹ / ₄ "
1351-0009	Ø 9,0 mm	18,5 cm / 7 ¹ / ₄ "
1351-0010	Ø 10,0 mm	18,5 cm / 7 ¹ / ₄ "
1351-0011	Ø 11,0 mm	18,5 cm / 7 ¹ / ₄ "
1351-0012	Ø 12,0 mm	18,5 cm / 7 ¹ / ₄ "
1351-0013	Ø 13,0 mm	18,5 cm / 7 ¹ / ₄ "
1351-0014	Ø 14,0 mm	18,5 cm / 7 ¹ / ₄ "
1351-0015	Ø 15,0 mm	18,5 cm / 7 ¹ / ₄ "
1351-0016	Ø 16,0 mm	18,5 cm / 7 ¹ / ₄ "
1351-0017	Ø 17,0 mm	18,5 cm / 7 ¹ / ₄ "
1351-0018	Ø 18,0 mm	18,5 cm / 7 ¹ / ₄ "
1351-0019	Ø 19,0 mm	18,5 cm / 7 ¹ / ₄ "
1351-0020	Ø 20,0 mm	18,5 cm / 7 ¹ / ₄ "
1351-0021	Ø 21,0 mm	18,5 cm / 7 ¹ / ₄ "
1351-0022	Ø 22,0 mm	18,5 cm / 7 ¹ / ₄ "
1351-0023	Ø 23,0 mm	18,5 cm / 7 ¹ / ₄ "
1351-0024	Ø 24,0 mm	18,5 cm / 7 ¹ / ₄ "
1351-0025	Ø 25,0 mm	18,5 cm / 7 ¹ / ₄ "
1351-0026	Ø 26,0 mm	18,5 cm / 7 ¹ / ₄ "
1351-0027	Ø 27,0 mm	18,5 cm / 7 ¹ / ₄ "
1351-0028	Ø 28,0 mm	18,5 cm / 7 ¹ / ₄ "
1351-0029	Ø 29,0 mm	18,5 cm / 7 ¹ / ₄ "
1351-0030	Ø 30,0 mm	18,5 cm / 7 ¹ / ₄ "

HEGAR

1351-0501	Ø 1,5 mm	18,5 cm / 7 ¹ / ₄ "
1351-0502	Ø 2,5 mm	18,5 cm / 7 ¹ / ₄ "
1351-0503	Ø 3,5 mm	18,5 cm / 7 ¹ / ₄ "
1351-0504	Ø 4,5 mm	18,5 cm / 7 ¹ / ₄ "
1351-0505	Ø 5,5 mm	18,5 cm / 7 ¹ / ₄ "
1351-0506	Ø 6,5 mm	18,5 cm / 7 ¹ / ₄ "
1351-0507	Ø 7,5 mm	18,5 cm / 7 ¹ / ₄ "
1351-0508	Ø 8,5 mm	18,5 cm / 7 ¹ / ₄ "
1351-0509	Ø 9,5 mm	18,5 cm / 7 ¹ / ₄ "
1351-0510	Ø 10,5 mm	18,5 cm / 7 ¹ / ₄ "
1351-0511	Ø 11,5 mm	18,5 cm / 7 ¹ / ₄ "
1351-0512	Ø 12,5 mm	18,5 cm / 7 ¹ / ₄ "
1351-0513	Ø 13,5 mm	18,5 cm / 7 ¹ / ₄ "
1351-0514	Ø 14,5 mm	18,5 cm / 7 ¹ / ₄ "
1351-0515	Ø 15,5 mm	18,5 cm / 7 ¹ / ₄ "
1351-0516	Ø 16,5 mm	18,5 cm / 7 ¹ / ₄ "
1351-0517	Ø 17,5 mm	18,5 cm / 7 ¹ / ₄ "

**HEGAR**

1351-0714 Ø 4,0 - Ø 17,0 mm

Satz, in Metalletui
 Set, in metal case
 Juego, en caja metalica
 Set, in scatola metallica
 (14 dilators)

HEGAR

1351-0726 Ø 1,0 - Ø 26,0 mm

Satz, in Metalletui
 Set, in metal case
 Juego, en caja metalica
 Set, in scatola metallica
 (26 dilators)

**HEGAR**

1351-0814 Ø 4,0 - Ø 17,0 mm

Satz, in Lederetui
 Set, in leather pouch
 Juego, en estuche de piel
 Set, in scatola de pelle
 (14 dilators)

HEGAR

1351-0826 Ø 1,0 - Ø 26,0 mm

Satz, in Lederetui
 Set, in leather pouch
 Juego, en estuche de piel
 Set, in scatola de pelle
 (26 dilators)

Uterus-Dilatatoren
Uterine Dilators
Dilatadores uterinos
Dilatatori uterini

030



HEGAR

- 1351-1101** Ø 3,0/4,0-Ø 17,0/18,0 mm (8 dilators)
1351-1102 Ø 1,0/2,0-Ø 25,0/26,0 mm (13 dilators)

Satz ohne auskochbare Stoffrolltasche

Set without bilable canvas roll

Juego sin bolsa de tela esterilizable por ebullición

Set senza busta di tela sterilizzabile

HEGAR

- 1351-1103** Ø 3,0/4,0-Ø 17,0/18,0 mm (8 dilators)
1351-1104 Ø 1,0/2,0-Ø 25,0/26,0 mm (13 dilators)

Satz in auskochbare Stoffrolltasche

Set in bilable canvas roll

Juego en bolsa de tela esterilizable por ebullición

Set in busta di tela sterilizzabile

HEGAR

1351-1002	Ø 1,0/ 2,0 mm	20,0 cm / 8"
1351-1004	Ø 3,0/ 4,0 mm	20,0 cm / 8"
1351-1006	Ø 5,0/ 6,0 mm	20,0 cm / 8"
1351-1008	Ø 7,0/ 8,0 mm	20,0 cm / 8"
1351-1010	Ø 9,0/10,0 mm	20,0 cm / 8"
1351-1012	Ø 11,0/12,0 mm	20,0 cm / 8"
1351-1014	Ø 13,0/14,0 mm	20,0 cm / 8"
1351-1016	Ø 15,0/16,0 mm	20,0 cm / 8"
1351-1018	Ø 17,0/18,0 mm	20,0 cm / 8"
1351-1020	Ø 19,0/20,0 mm	20,0 cm / 8"
1351-1022	Ø 21,0/22,0 mm	20,0 cm / 8"
1351-1024	Ø 23,0/24,0 mm	20,0 cm / 8"
1351-1026	Ø 25,0/26,0 mm	20,0 cm / 8"



HEGAR

- 1351-1107** Ø 3,0/4,0-Ø 17,0/18,0 mm

Satz in Metalletui

Set in metalcase

Juego en caja metalica

Set in scatola metallica

(8 dilators)



HANK

1351-1510	Ø 4,5/ 5,0 mm	Fig. 9/10
1351-1512	Ø 5,5/ 6,0 mm	Fig.11/12
1351-1514	Ø 6,5/ 7,0 mm	Fig.13/14
1351-1516	Ø 7,5/ 8,0 mm	Fig.15/16
1351-1518	Ø 8,5/ 9,0 mm	Fig.17/18
1351-1520	Ø 9,5/10,0 mm	Fig.19/20



HANK

1351-1500 Ø 4,5/5,0-Ø 9,5/10,0 mm (6 dilators)

Satz in auskochbarer Stoffrolltasche
 Set in boilable canvas roll
 Juego en bolsa de tela esterilizable por ebullición
 Set in busta di tela sterilizzabile



PRATT

1351-1215	Ø 4,5/ 5,0 mm	Charr. 13/15
1351-1219	Ø 5,5/ 6,0 mm	Charr. 17/19
1351-1223	Ø 7,5/ 8,0 mm	Charr. 21/23
1351-1227	Ø 8,5/ 9,0 mm	Charr. 25/27
1351-1231	Ø 9,5/10,0 mm	Charr. 29/31
1351-1235	Ø 11,5/12,0 mm	Charr. 33/35
1351-1239	Ø 12,5/13,0 mm	Charr. 37/39
1351-1243	Ø 13,5/14,0 mm	Charr. 41/43

1351-1208 Ø 3,0/4,0-Ø 17,0/18,0 mm (8 dilators)

Satz in auskochbarer Stoffrolltasche

Set in boilable canvas roll

Juego en bolsa de tela esterilizable por ebullición

Set in busta di tela sterilizzabile



biegsam
 malleable
 maleable
 malleabile

SIMS

1351-2132 32,0 cm / 12¹/₂"



starr
 rigid
 rigido
 rigido

SIMS

1351-2032 32,0 cm / 12¹/₂"



biegsam
 malleable
 maleable
 malleabile

MARTIN

1351-2332 32,0 cm / 12¹/₂"



graduiert
 graduated
 graduado
 graduato

COLLIN

1351-2428 28,0 cm / 11"



VALLEIX

1351-2425 25,0 cm / 10"



BRAUN

1352-0026 28,0 cm / 11"

Hakenzangen
Uterine Tenaculum Forceps
Pinzas para coger el cuello del útero
Pinze per abbassare il collo dell'utero

030



STAUDE-MOORE

1352-0817 17,0 cm / 6³/₄"

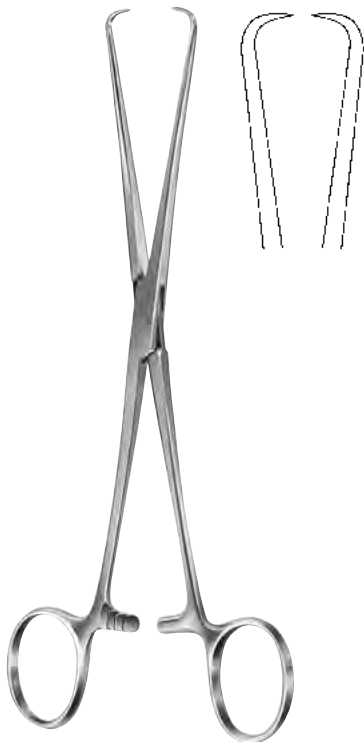

BARRETT

1352-1018 18,0 cm / 7"

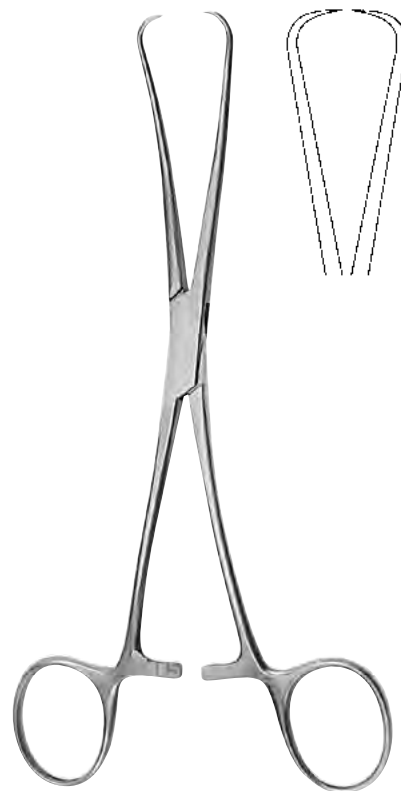

JARCHO

1352-1020 20,0 cm / 8"



SCHROEDER

1352-0425 25,0 cm / 9³/₄"

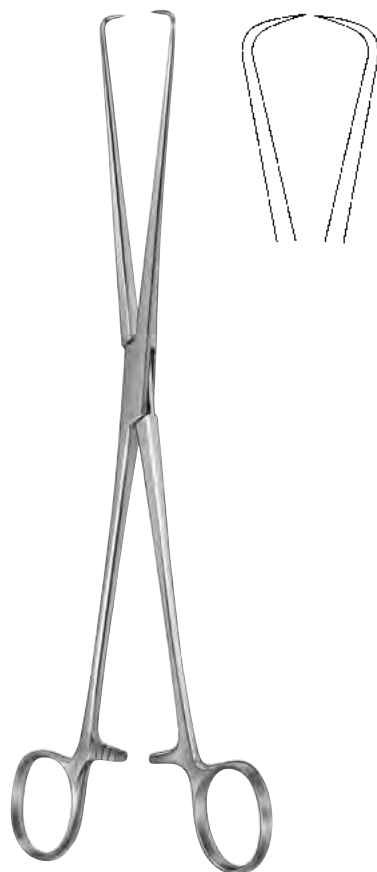

BRAUN

1352-0625 25,0 cm / 9³/₄"

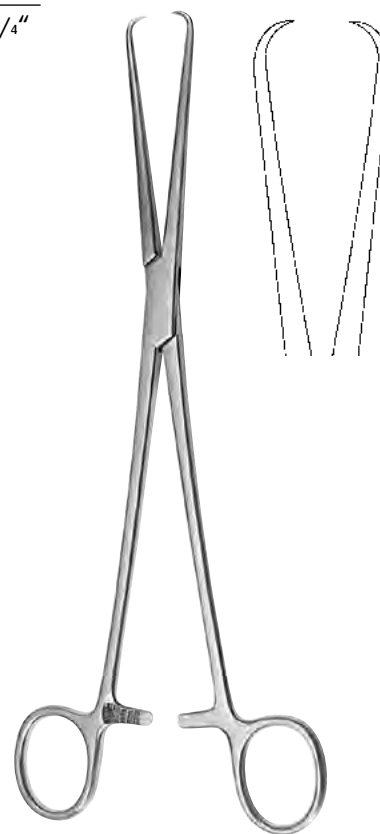

POZZI

1352-1026 25,5 cm / 10¹/₄"

Hakenzangen
Uterine Tenaculum Forceps
Pinzas para coger el cuello del útero
Pinze per abbassare il collo dell'utero

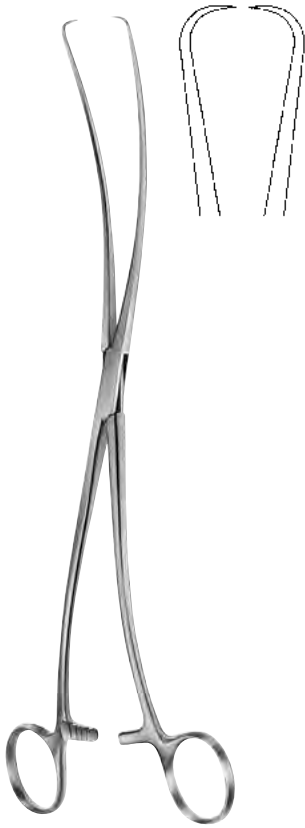

DUPLAY

1352-0928 28,0 cm / 11"



Amniotom
 Amniotome
 Amniótomo
 Amniotomo

BEACHAM

1352-1226 26,0 cm / 10¹/₄"



SKENE

1352-1124 24,0 cm / 9¹/₂"



SCHROEDER

1352-1424 25,0 cm / 9³/₄"



SCHROEDER

1352-1524 25,0 cm / 9¹/₂"



3x4 Zähne
 3x4 teeth
 3x4 dientes
 3x4 denti

TEALE

1352-1723 23,0 cm / 9"

Hakenzangen
Uterine Tenaculum Forceps
Pinzas para coger el cuello del útero
Pinze per abbassare il collo dell'utero

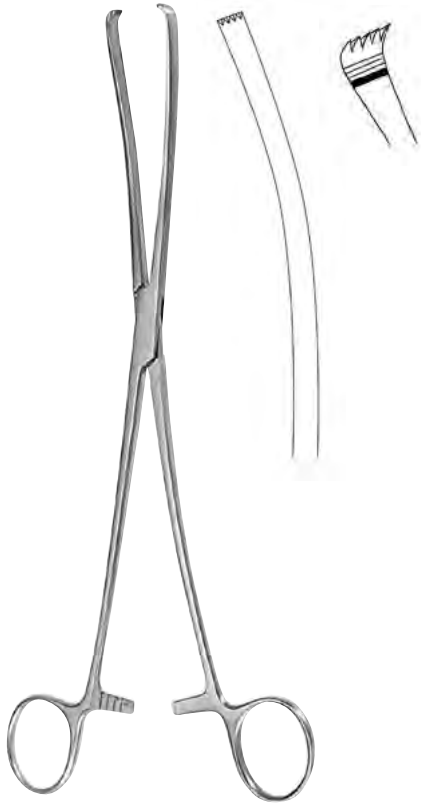

IOWA
 1352-1926 26,0 cm / 10¹/₄"



6 mm
 1352-2006

8 mm
 1352-2008

10 mm
 1352-2010

MUSEUX
 1352-2006 - 1352-2010 24,0 cm / 9¹/₂"



6 mm
 1352-2106

8 mm
 1352-2108

10 mm
 1352-2110

MUSEUX
 1352-2106 - 1352-2110 24,0 cm / 9¹/₂"



JACOBS
 1352-2221 21,0 cm / 8¹/₄"



JACOBS
 1352-2321 21,0 cm / 8¹/₄"

Hakenzangen
Uterine Tenaculum Forceps
Pinzas para coger el cuello del útero
Pinze per abbassare il collo dell'utero

030

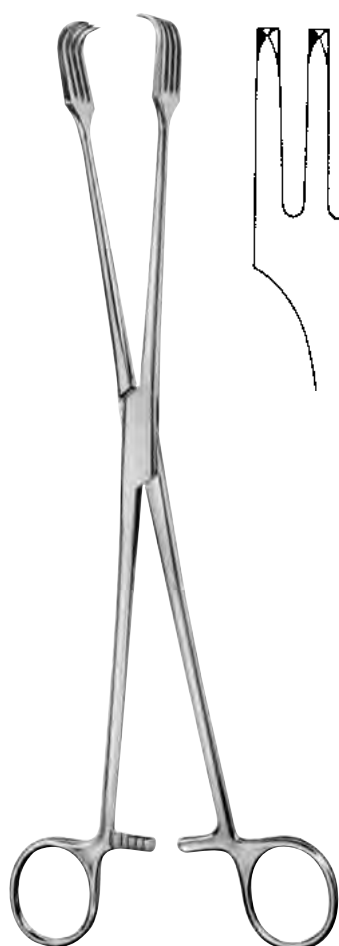

1352-2428 26,0 cm / 10¹/₄"

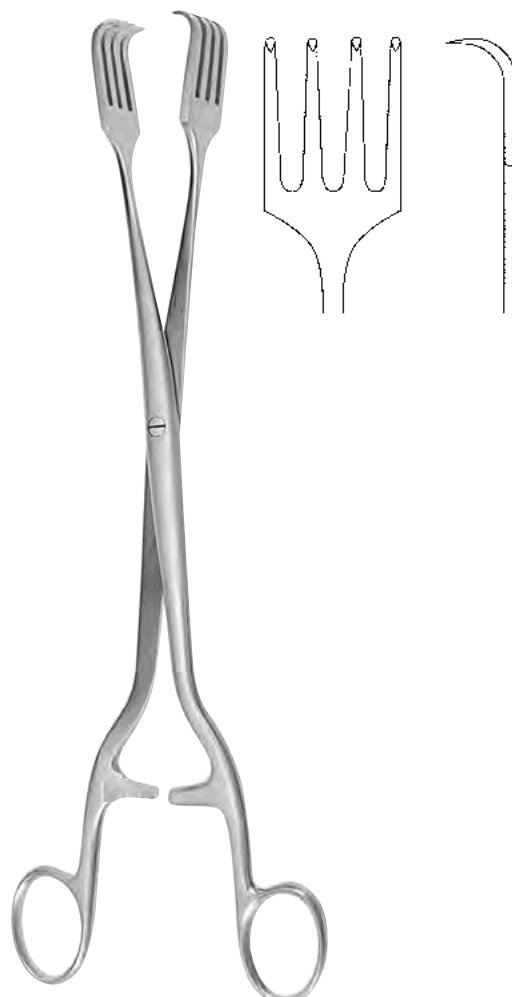

PRATT
1352-2527 28,0 cm / 11"

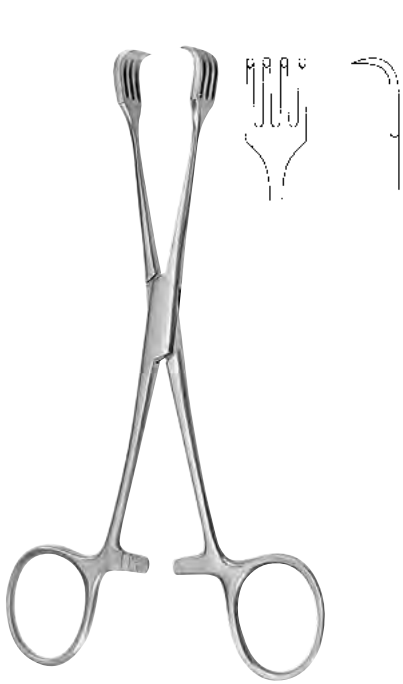
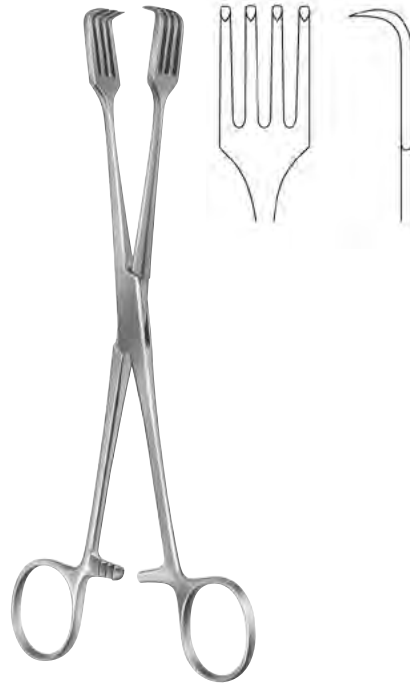
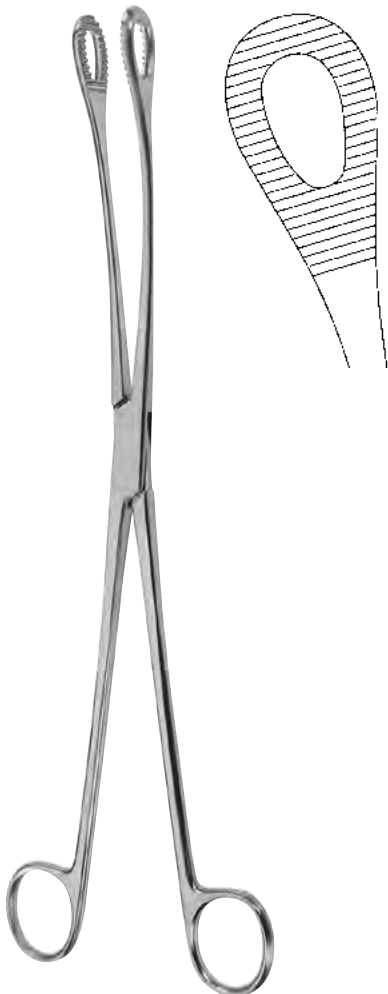
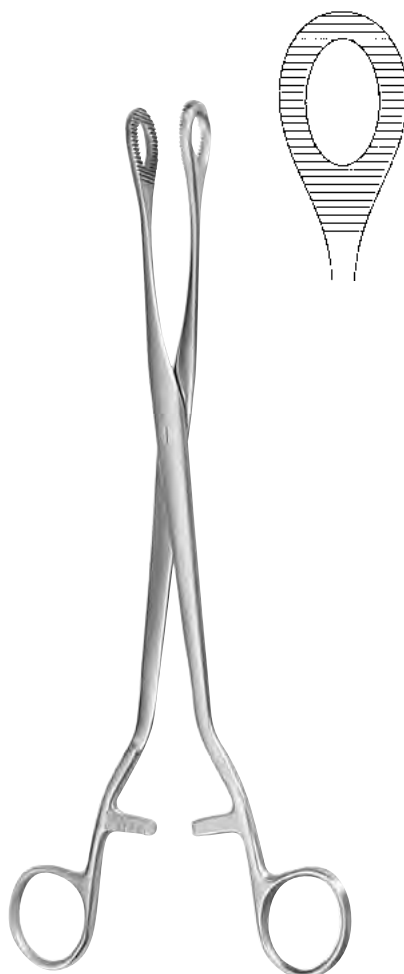
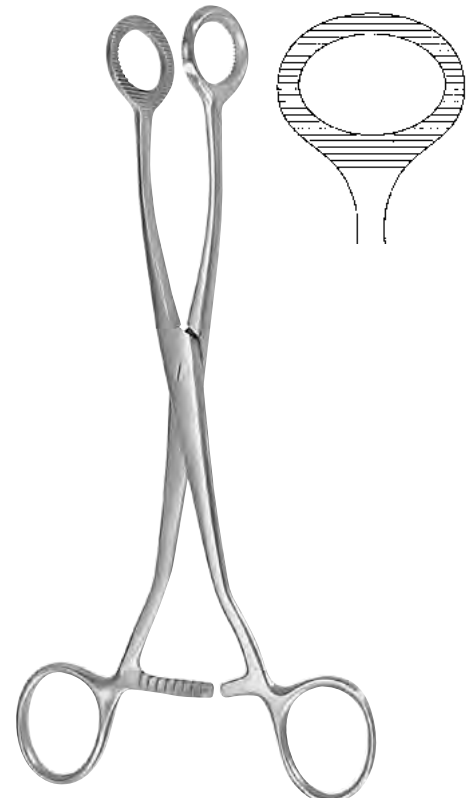
**BRAUN****1352-2803** 15,5 cm / 6"**CZERNY****1352-2621** 20,5 cm / 8"**KELLY****1157-2532** 32,0 cm / 12¹/₂"**NOTO****1157-2627** 27,0 cm / 10⁵/₈"**DOYEN****1352-2220** 20,0 cm / 8"

Uterusfaßzangen
Uterine Elevating Forceps
Pinzas para el útero
Pinze per afferrare l'utero

030

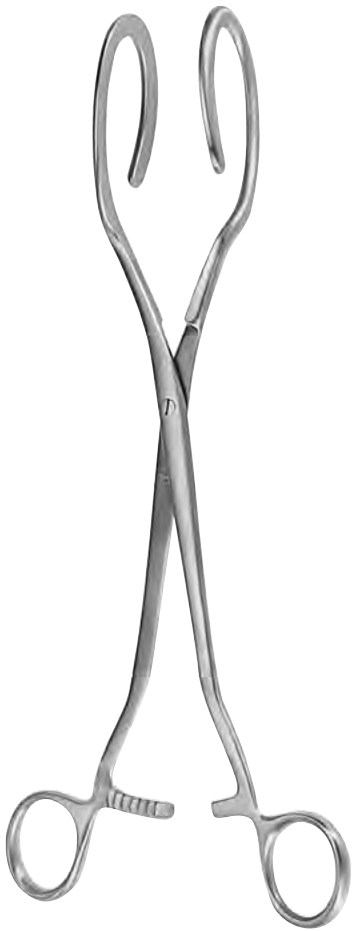

DARTIGUES

1352-3027 27,0 cm / 10³/₄"



SOMER

1352-3123 23,0 cm / 9"



COLLIN

1352-3225 25,0 cm / 9³/₄"

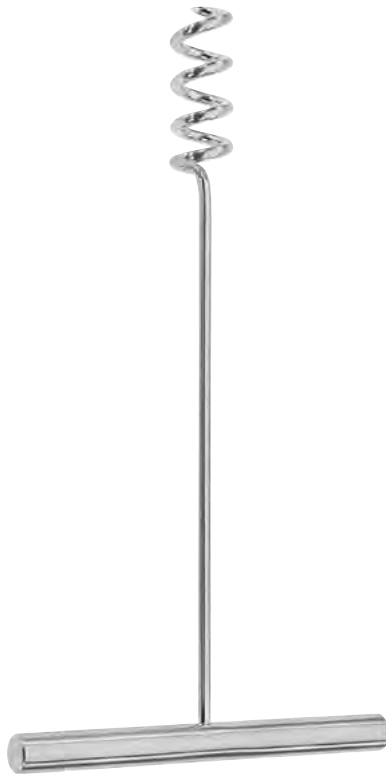

DOYEN
 1352-3417 17,0 cm / 6³/₄"

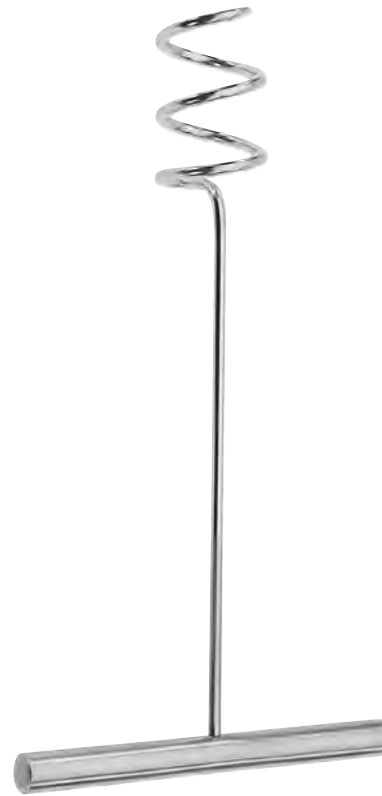

DOYEN
 1352-3317 17,0 cm / 6³/₄"



1161-3101



1161-3105



1161-3100



1161-3106



1161-3104

EMMET

1161-3101 - 1161-3104 22,0 cm / 8³/₄"

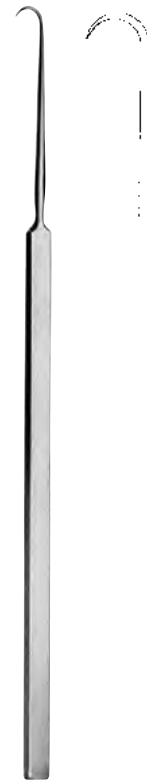

SIMON

1161-3102 22,0 cm / 8³/₄"

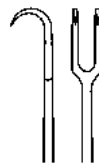

SIMON

1161-3103 22,0 cm / 8³/₄"

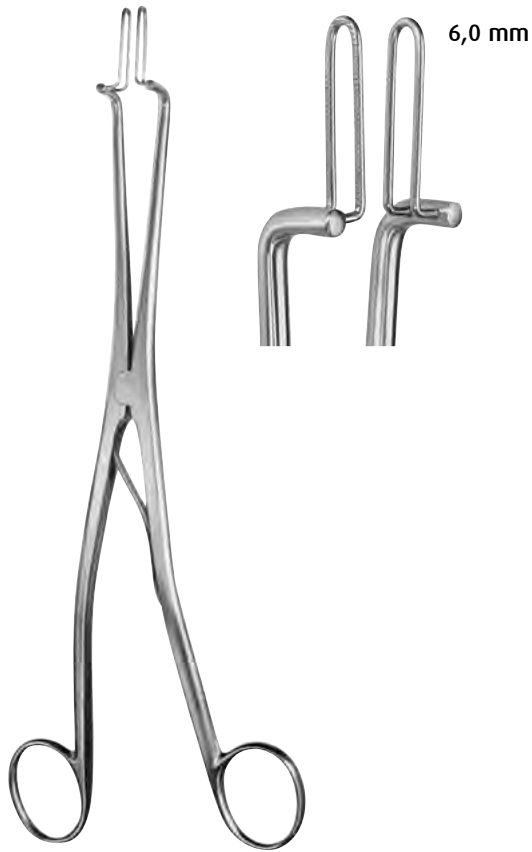

KOGAN
 1350-9724 24,0 cm / 9 1/2"



KOGAN
 1350-9824 24,0 cm / 9 1/2"



KOGAN
 1350-0924 - 1350-0925 28,0 cm / 11"



1350-0924



1350-0926



1350-0925



GOODELL

1351-0034 34,0 cm / 13¹/₂"

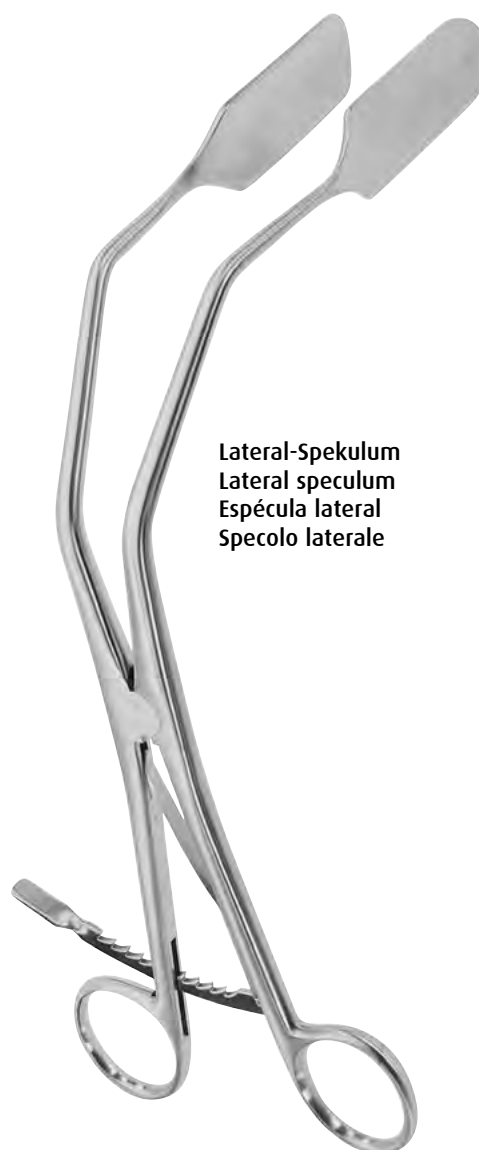

Lateral-Spekulum
Lateral speculum
Espécula lateral
Specolo laterale

1351-0160 60x22 mm 25,0 cm / 10"
1351-0172 72x22 mm 25,0 cm / 10"

Biopsieküretten
Biopsy Curettes
Curetas para biopsià
Curette per biopsia

030



RANDALL
1353-0304 23,0 cm / 9" Ø 4,0 mm



NOVAK
1353-0102 23,0 cm / 9" Ø 2 mm
1353-0104 23,0 cm / 9" Ø 4 mm



KEVORKIAN
1353-0504 30,0 cm / 12"



KEVORKIAN
1353-0604 30,0 cm / 12"



KEVORKIAN
1353-0404 30,0 cm / 12"



GELLHORN
 1354-0923 23,0 cm / 9"



FAURE
 1354-0121 21,0 cm / 8 1/4"



SCHUBERT
 1354-0221 21,0 cm / 8 1/4"
 1354-0229 29,0 cm / 11 1/2"



SCHUBERT
 1354-0326 26,0 cm / 10 1/4"



THOMS-GAYLOR

1354-0722 22,0 cm / 8³/₄"
1354-0724 24,0 cm / 9¹/₂"

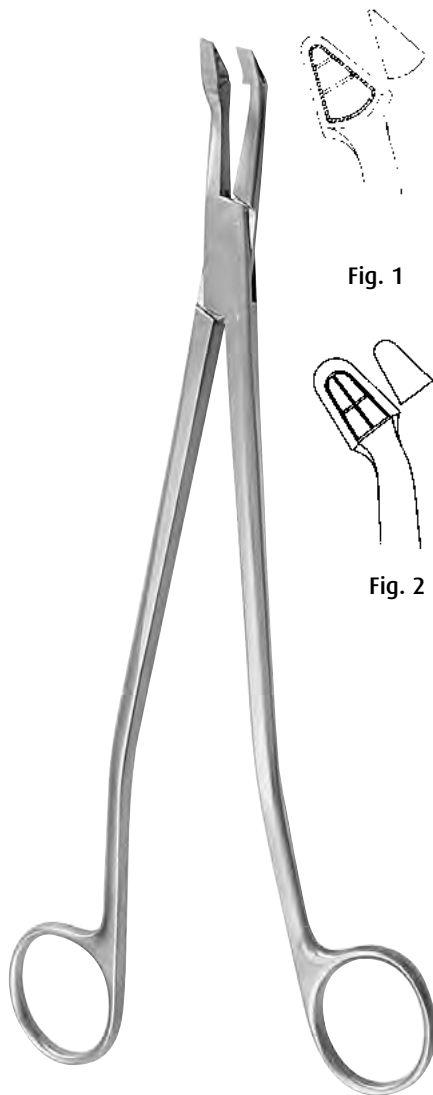

Fig. 1

Fig. 2

VAN DOREN

1354-0524 25,0 cm / 9³/₄" Fig. 1
1354-0626 25,0 cm / 9³/₄" Fig. 2



VAN DOREN

1354-0625 25,5 cm / 10"

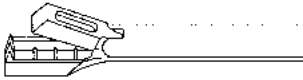
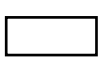
**KEVORKIAN**

1354-1624 25,0 cm / 10" 3x9 mm

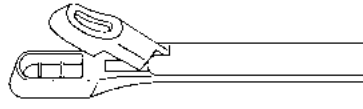
**EPPENDORFER**

1354-1423 20,0 cm / 8" 4x8 mm

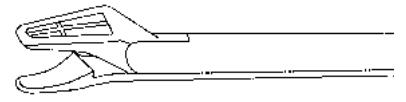
**ALEXANDER**

1354-1028 28,0 cm / 11"

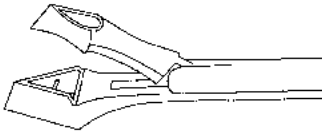
**SCHUMACHER**

1354-1201 24,0 cm / 9½" 4,5x7 mm

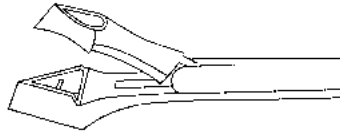
**SCHUMACHER**

1354-1202 24,0 cm / 9½" 6x9 mm

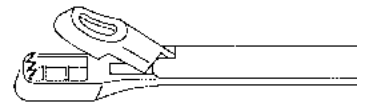
**WITTNER**

1354-2023 23,0 cm / 9" 4,5x8 mm

**WITTNER**

1354-2123 23,0 cm / 9" 4,5x8 mm

Uterus Biopsiezangen
Cervical Biopsy and Specimen Forceps
Pinzas saca-bocados para biopsia
Pinze per la biopsia cervicale e da prelievo

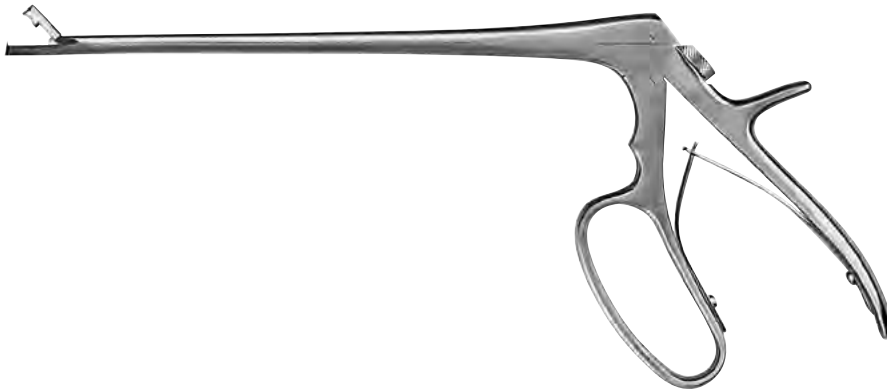

TISCHLER-MORGAN

1354-5022 21,0 cm / 8¹/₄" 7x3 mm
1354-5025 25,0 cm / 9³/₄" 7x3 mm



MINI-TOWNSEND

1354-6021 21,0 cm / 8¹/₄" 2,3x5 mm



BABY-TISCHLER

1354-4820 21,0 cm / 8¹/₄" 2,3x5 mm



TISCHLER-KEVORKIAN

1354-4222 21,0 cm / 8¹/₄" 3x9 mm



KEVORKIAN-PACIFIC

1354-4422 21,0 cm / 8¹/₄" 3x8 mm

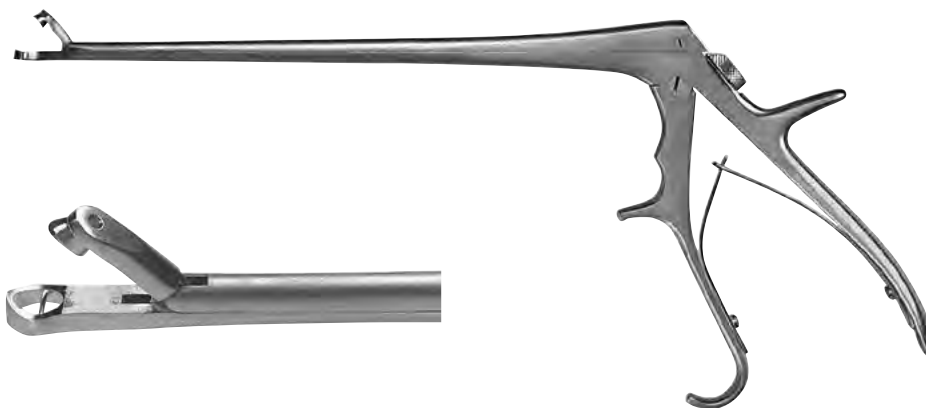

BURKE

1354-4022 21,0 cm / 8¹/₄" 7x5 mm



1354-6000
 Griff allein
 handle only
 manico solo
 mango suelto

Aufsätze allein
 Tips only
 Puntas sueltas
 Punti solo

1354-6001 Fig.1
1354-6003 Fig.3
1354-6002 Fig.4
1354-6005 Fig.5
 komplett
 complete
 completo
 completo



TISCHLER MORGAN
1354-6101 Fig.1



TOWNSEND
1354-6103 Fig.3



KEVORKIAN
1354-6102 Fig.4



**MINI-TOWNSEND
 (BABY-TISCHLER)**
1354-6105 Fig.5

Probeexzisionszangen, IUP-Fasszangen
Uterine Biopsy Forceps, IUP Grasping Forceps
Pinze para biopsia, Pinzas para coger intra-uterinos
Pinze per biopsia, Pinze intra-uterine

030

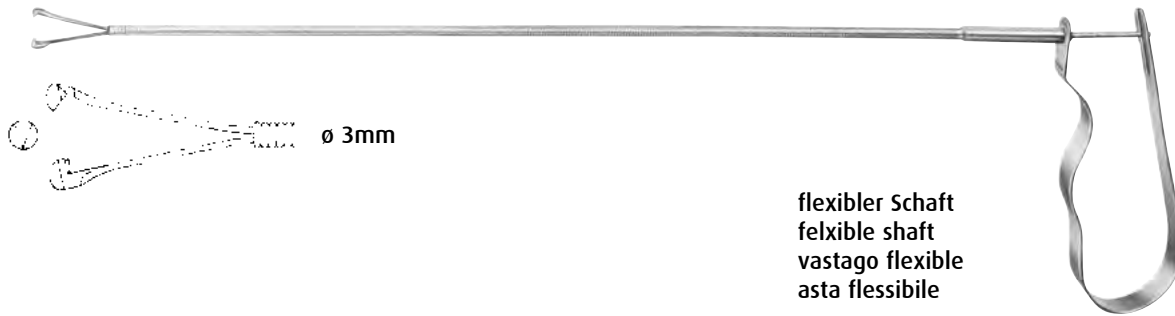

flexibler Schaft
 flexible shaft
 vastago flexible
 asta flessibile

SERPENTINE

1354-8022 22,0 cm / 8³/₄"
1354-8028 28,5 cm / 11¹/₄"



SCHUMACHER

1357-7103

Aufsatz allein
 Tip only
 Punta suelta
 Punta, sola

SCHUMACHER

1357-7003 25,0 cm / 9³/₄"

komplett
 complete
 completo
 completo



scharf, fest
 sharp, rigid
 cortante, rigido
 tagliente, rigido



1355-0501

Fig.1



1355-0502

Fig.2



1355-0503

Fig.3

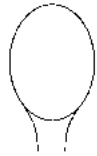

1355-0504

Fig.4



1355-0505

Fig.5



1355-0506

Fig.6

SIMON

1355-0501 - 1355-0506

25,0 cm / 9³/₄"



scharf, fest
 sharp, rigid
 cortante, rigido
 tagliente,
 rigido



1355-0201

Fig.1



1355-0202

Fig.2



1355-0203

Fig.3

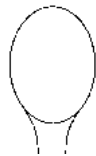

1355-0204

Fig.4



1355-0205

Fig.5



1355-0206

Fig.6

SCHROEDER

1355-0201 - 1355-0206

30,0 cm / 11³/₄"

scharf, fest
 sharp, rigid
 cortante, rigido
 tagliente, rigido

scharf, biegsam
 sharp, malleable
 cortante, malleabile
 tagliente, malleabile

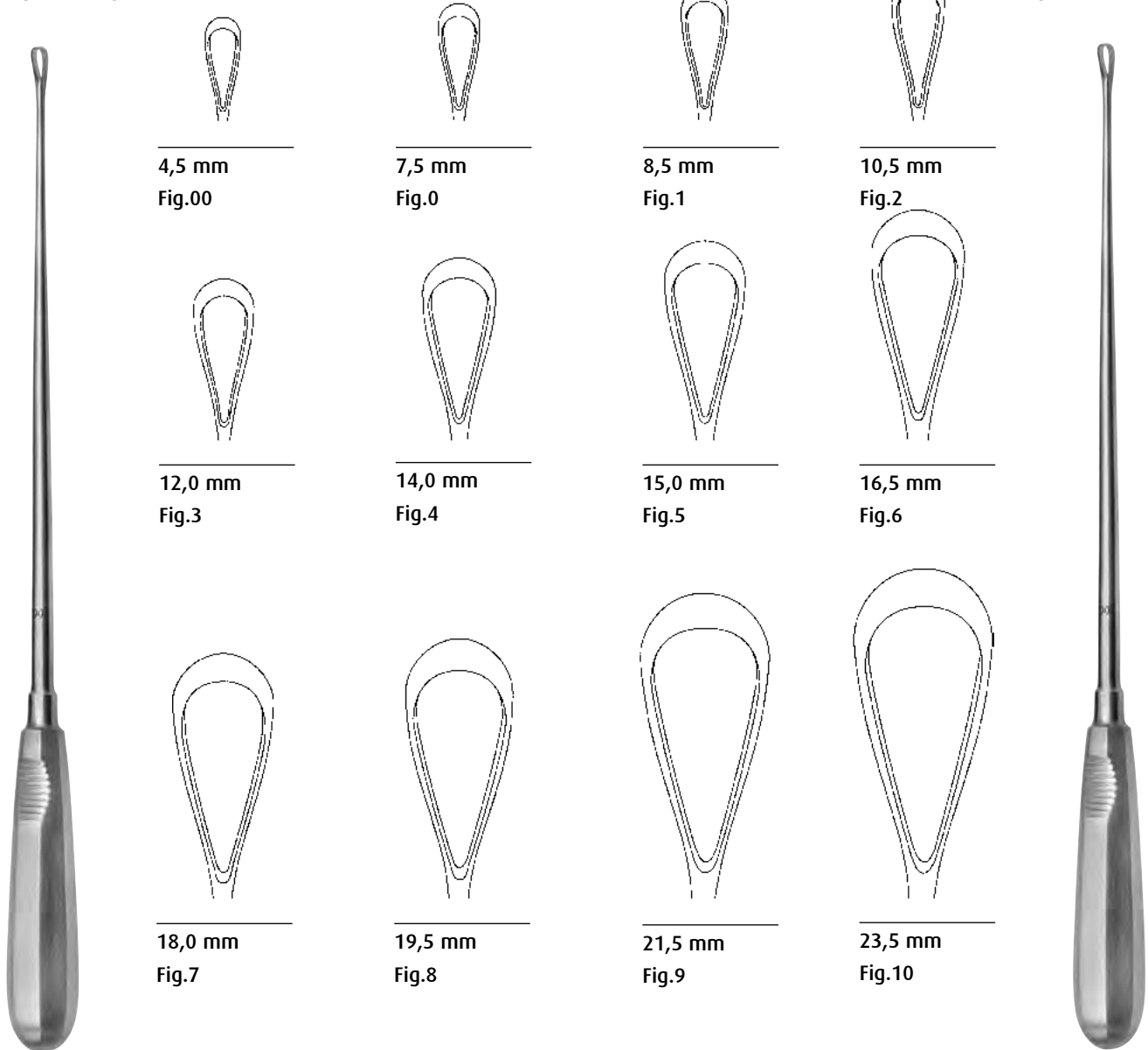

RECAMIER

1355-1504	Fig.00	31,0 cm / 12 ¹ / ₄ "
1355-1507	Fig.0	31,0 cm / 12 ¹ / ₄ "
1355-1508	Fig.1	31,0 cm / 12 ¹ / ₄ "
1355-1510	Fig.2	31,0 cm / 12 ¹ / ₄ "
1355-1012	Fig.3	31,0 cm / 12 ¹ / ₄ "
1355-1514	Fig.4	31,0 cm / 12 ¹ / ₄ "
1355-1515	Fig.5	31,0 cm / 12 ¹ / ₄ "
1355-1516	Fig.6	31,0 cm / 12 ¹ / ₄ "
1355-1518	Fig.7	31,0 cm / 12 ¹ / ₄ "
1355-1519	Fig.8	31,0 cm / 12 ¹ / ₄ "
1355-1521	Fig.9	31,0 cm / 12 ¹ / ₄ "
1355-1523	Fig.10	31,0 cm / 12 ¹ / ₄ "

RECAMIER

1355-1608	Fig.1	31,0 cm / 12 ¹ / ₄ "
1355-1610	Fig.2	31,0 cm / 12 ¹ / ₄ "
1355-1612	Fig.3	31,0 cm / 12 ¹ / ₄ "
1355-1614	Fig.4	31,0 cm / 12 ¹ / ₄ "
1355-1615	Fig.5	31,0 cm / 12 ¹ / ₄ "
1355-1616	Fig.6	31,0 cm / 12 ¹ / ₄ "
1355-1618	Fig.7	31,0 cm / 12 ¹ / ₄ "
1355-1619	Fig.8	31,0 cm / 12 ¹ / ₄ "



stumpf, fest
 blunt, rigid
 romo, rigida
 smusso, rigido

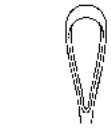

4,5 mm
 Fig.00



7,5 mm
 Fig.0



8,5 mm
 Fig.1



10,5 mm
 Fig.2



12,0 mm
 Fig.3



14,0 mm
 Fig.4



15,0 mm
 Fig.5

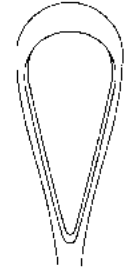

16,5 mm
 Fig.6

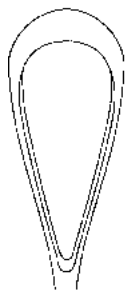

18,0 mm
 Fig.7

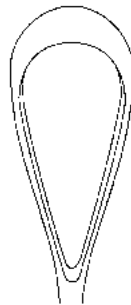

19,5 mm
 Fig.8

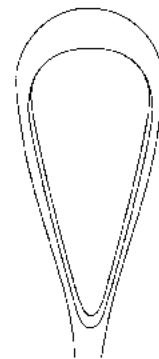

21,5 mm
 Fig.9

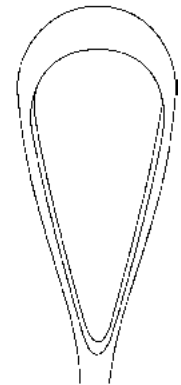

23,5 mm
 Fig.10

RECAMIER

1355-2505	Fig.00	31,0 cm / 12 ¹ / ₄ "
1355-2507	Fig.0	31,0 cm / 12 ¹ / ₄ "
1355-2508	Fig.1	31,0 cm / 12 ¹ / ₄ "
1355-2510	Fig.2	31,0 cm / 12 ¹ / ₄ "
1355-2512	Fig.3	31,0 cm / 12 ¹ / ₄ "
1355-2514	Fig.4	31,0 cm / 12 ¹ / ₄ "
1355-2515	Fig.5	31,0 cm / 12 ¹ / ₄ "
1355-2516	Fig.6	31,0 cm / 12 ¹ / ₄ "
1355-2518	Fig.7	31,0 cm / 12 ¹ / ₄ "
1355-2519	Fig.8	31,0 cm / 12 ¹ / ₄ "
1355-2521	Fig.9	31,0 cm / 12 ¹ / ₄ "
1355-2523	Fig.10	31,0 cm / 12 ¹ / ₄ "

Uterusküretten
Uterine Curettes
Curetas uterinas
Curette uterine

030

scharf, fest
 sharp, rigid
 cortante, rigido
 tagliente, rigido

scharf, biegsam
 sharp, malleable
 cortante, maleable
 tagliente, malleable

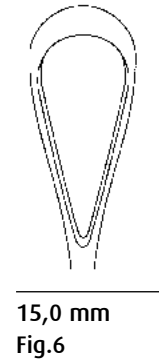
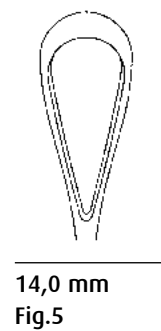
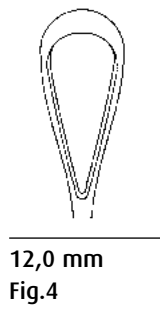
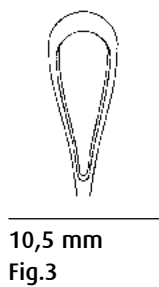
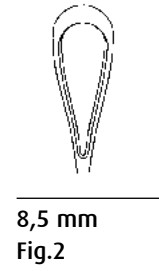
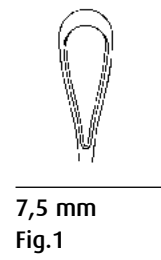
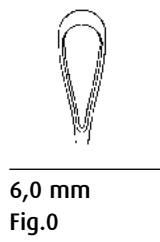
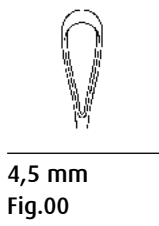

SIMS

1355-2005	Fig.00	28,0 cm / 11"
1355-2006	Fig.0	28,0 cm / 11"
1355-3001	Fig.1	28,0 cm / 11"
1355-3002	Fig.2	28,0 cm / 11"
1355-3003	Fig.3	28,0 cm / 11"
1355-3004	Fig.4	28,0 cm / 11"
1355-3005	Fig.5	28,0 cm / 11"
1355-3006	Fig.6	28,0 cm / 11"

SIMS

1355-2107	Fig.1	28,0 cm / 11"
1355-2108	Fig.2	28,0 cm / 11"
1355-2109	Fig.3	28,0 cm / 11"
1355-2111	Fig.4	28,0 cm / 11"
1355-2112	Fig.5	28,0 cm / 11"
1355-2114	Fig.6	28,0 cm / 11"

stumpf, fest
 blunt, rigid
 romo, rigida
 smusso, rigido



4,5 mm
 Fig.00



6,0 mm
 Fig.0



7,5 mm
 Fig.1



8,5 mm
 Fig.2



10,5 mm
 Fig.3



12,0 mm
 Fig.4



14,0 mm
 Fig.5



15,0 mm
 Fig.6

SIMS

1355-2205	Fig.00	28,0 cm / 11"
1355-2206	Fig.0	28,0 cm / 11"
1355-2207	Fig.1	28,0 cm / 11"
1355-2208	Fig.2	28,0 cm / 11"
1355-2209	Fig.3	28,0 cm / 11"
1355-2210	Fig.4	28,0 cm / 11"
1355-2211	Fig.5	28,0 cm / 11"
1355-2212	Fig.6	28,0 cm / 11"

stumpf, fest
 blunt, rigid
 romo, rigida
 smusso, rigido

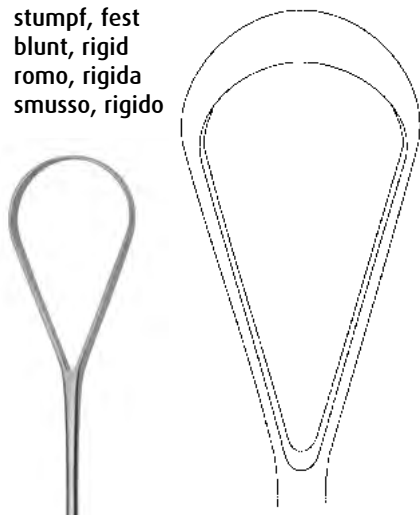

34,5 mm
 Fig.1

scharf, biegsam
 sharp, malleable
 cortante, maleable
 tagliente, malleabile

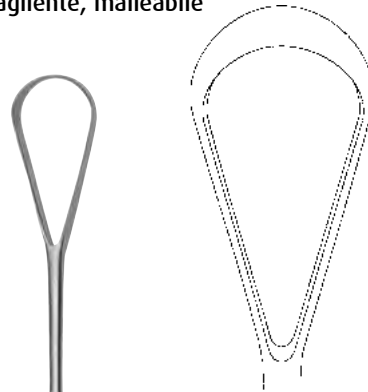

23,5 mm
 Fig.1

stumpf, biegsam
 blunt, malleable
 romo, maleable
 smusso, malleabile

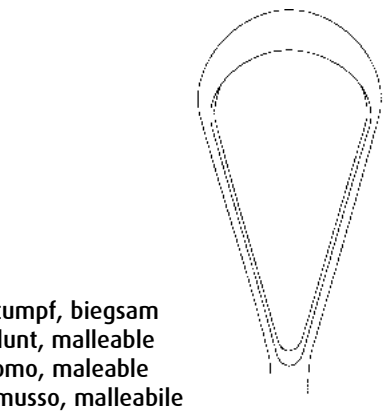

23,5 mm
 Fig.1

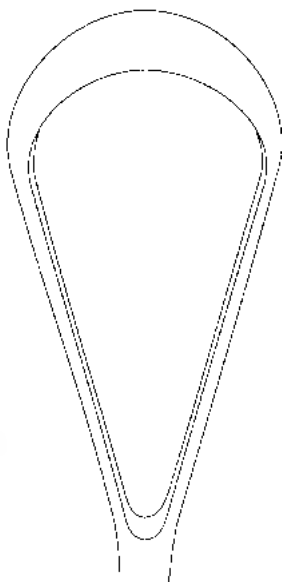

39,5 mm
 Fig.2

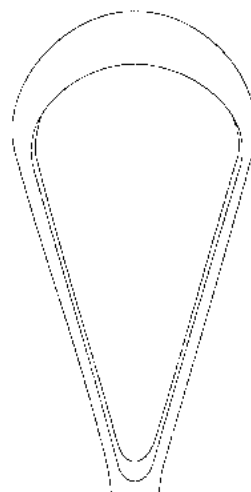

28,5 mm
 Fig.3

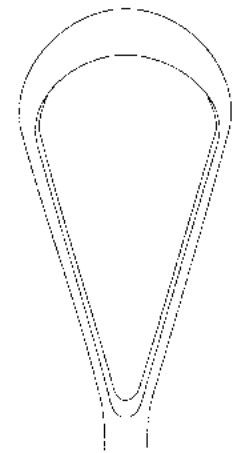

26,0 mm
 Fig.2

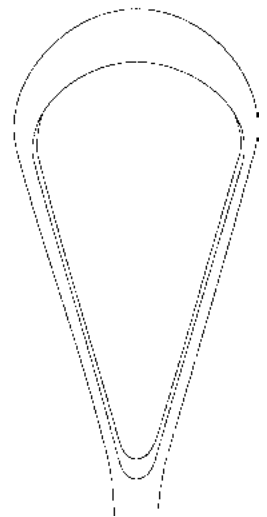

28,5 mm
 Fig.3

RECAMIER

- 1355-2534 36,0 cm / 14¹/₄" Fig.1
- 1355-2539 36,0 cm / 14¹/₄" Fig.2

BUMM

- 1355-1623 31,0 cm / 12¹/₄" Fig.1
- 1355-1628 31,0 cm / 12¹/₄" Fig.3

BUMM

- 1355-2623 31,0 cm / 12¹/₄" Fig.1
- 1355-2626 31,0 cm / 12¹/₄" Fig.2
- 1355-2628 31,0 cm / 12¹/₄" Fig.3

030

Uteruslöffel
Uterine Scoopes
Curetas uterinas
Curette uterine

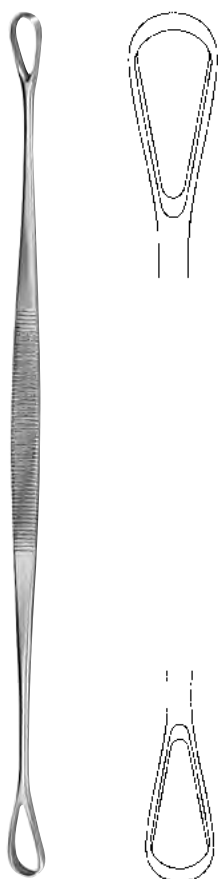

scharf/stumpf
sharp/blunt
cortante/romo
tagliante/smusso

BLAKE

1352-0227

27,0 cm / 10³/₄''

Absaugküretten
Suction Curettes
Curetas aspiradoras
Curette per aspirazione

030



1353-0903 Ø 3,0 mm



1353-0904 Ø 4,5 mm



1353-0906 Ø 6,0 mm



1353-0908 Ø 8,0 mm



1353-0910 Ø 10,0 mm



1353-0912 Ø 12,0 mm



1353-0914 Ø 14,0 mm

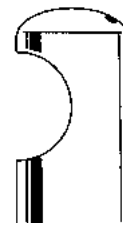

1353-0950 12,0 cm, 4³/₄"

Kupplungsstück
Coupling Piece
Pieza de acoplamiento
Pezzo di collegamento

1353-0951

Dichtungsring (Paar) für Kupplungsstück
Gasket rings (pair) for coupling piece
Anillos de cierre (par) para pieza de acoplamiento
Anelli di tenuta (paio) per pezzo di collegamento

1353-0903 - 1353-0914 29,0 cm / 11¹/₂"

**SCHULTZE****1353-2100**

Komplett im Holzetui
Complete in wooden case
Completo en estuche de madera
Completo in scatola di legno

**SCHULTZE****1353-2200****DRUCK****1353-2300**

Manometer allein
Manometer only
Manometro solo
Manometro solo



MARTIN

1357-0134 34,0 cm / 13³/₈"



COLLIN

1357-0335 35,0 cm / 13³/₄"

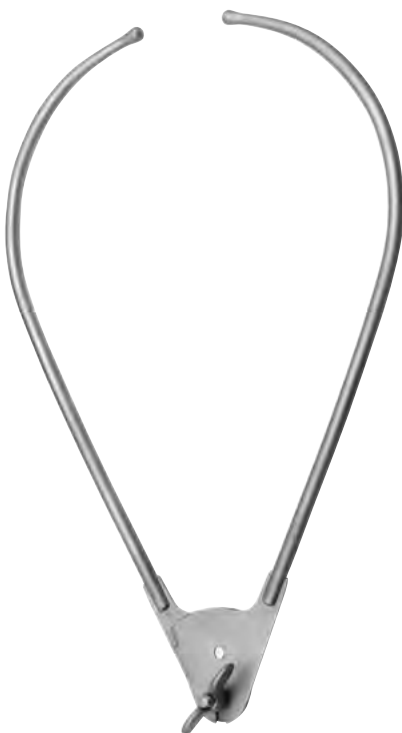

COLLYER

1357-0530 30,0 cm / 13³/₄"

**WRIGLEY**

1357-2129 28,0 cm / 11"

**SIMPSON**

1357-1323 23,0 cm / 9"
1357-1330 30,0 cm / 1³/₄"

**SIMPSON-BRAUN**

1357-1336 36,0 cm / 14¹/₈"

**DE LEE**

1357-1036 36,0 cm / 4¹/₄"



MCLEAN-TUCKER

1357-1639 39,0 cm / 15¹/₂"



MCLEAN-LUIKART

1357-1636 39,0 cm / 15¹/₂"



NAEGELE

1357-1136 36,0 cm / 14¹/₄"
1357-1140 40,0 cm / 16"



KIELLAND

1357-1541 41,0 cm / 16¹/₂"



PIPER

1357-1744 44,0 cm / 17¹/₄"



SELLHEIM

1357-3128 28,0 cm / 11"



GREEN-ARMYTAGE

1357-3221 21,0 cm / 8¹/₄"

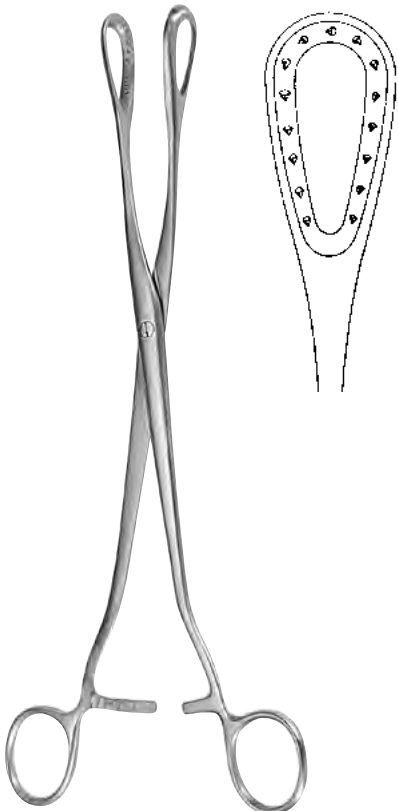

SAENGER

1357-5227 27,0 cm / 10³/₄"

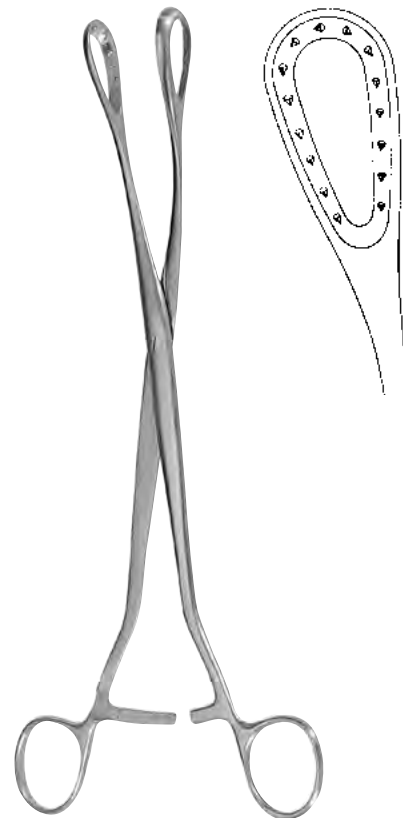

SAENGER

1357-5327 27,0 cm / 10³/₄"

Plazenta- und Abortuszangen
Placenta and Ovum Forceps
Pinzas para aborto y placenta
Pinze per placenta e per ovaie

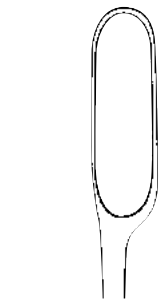
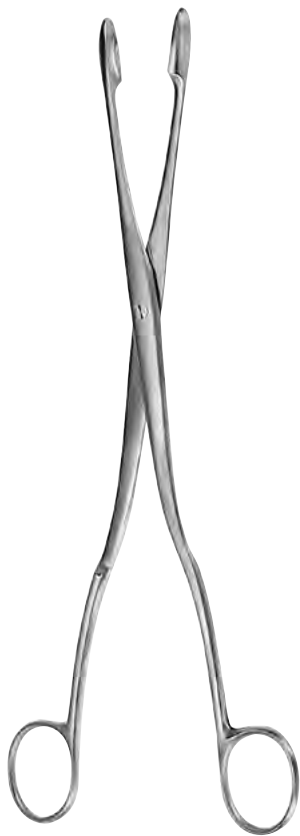

1357-5001 Fig.1



1357-5002 Fig.2

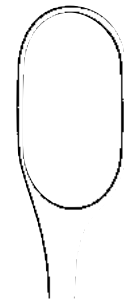

1357-5003 Fig.3



1357-5102 Fig.1



1357-5103 Fig.2



1357-5103 Fig.3

WINTER

1357-5001 - 1357-5103

28,0 cm / 11"



1357-5112 Fig.2

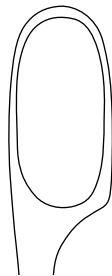

1357-5113 Fig.3

WINTER

1357-5112 - 1357-5113

28,0 cm / 11"



14 mm

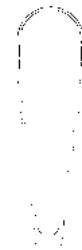

Fig.1

1357-5104

18 mm

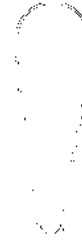

Fig. 2

1357-5418

20 mm



Fig. 3

1357-5420

stumpf, Rückseite gerieft
 blunt, backside serrated
 romo, dorso estriado
 smusso, dorso scanalato

CUZZI

1357-5104 - 1357-5420

30,0 cm / 11³/₄"

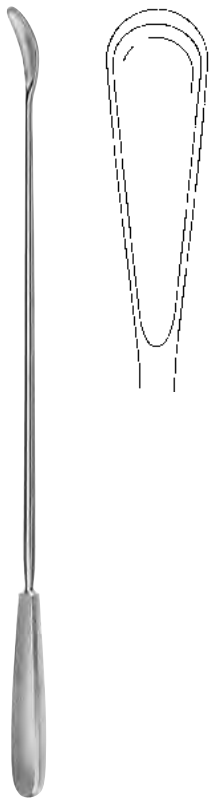
**WALLICH**

1353-0242 42,0 cm / 17"

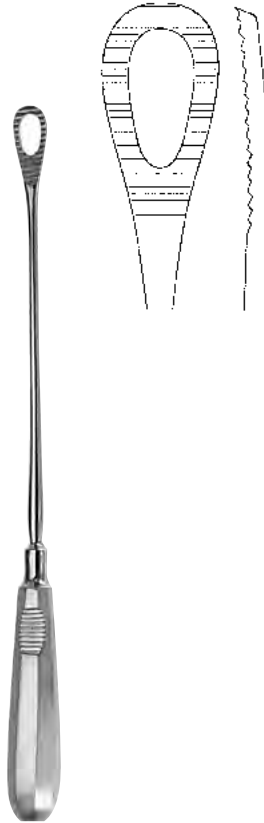
**PESTALOZZA**

1357-5630 30,0 cm / 11³/₄"

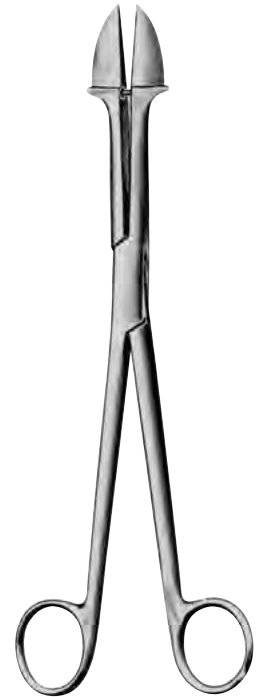
**SMELLIE**

1357-3625 25,0 cm / 10"

**BRAUN**

1357-3530 30,0 cm / 11³/₄"

**COLLIN**

1357-3709 9,0 cm / 3¹/₂"

**KANE**

1357-3909 8,5 cm / 3¹/₄"



BRAUN
1357-3842 42,0 cm / 16¹/₂"

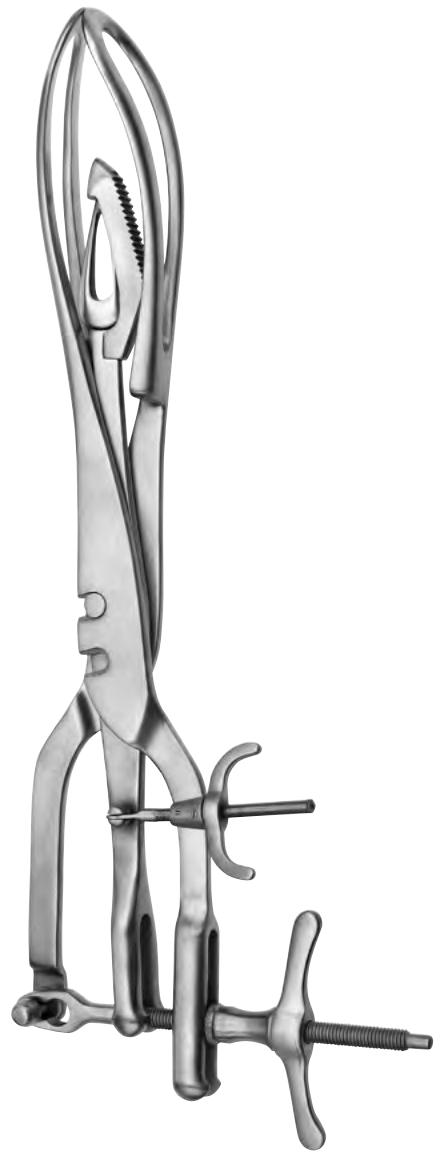

TARNIER
1357-3846 46,0 cm / 18"

032

**Ophthalmologie
Ophthalmology
Oftalmología
Ophthalmologia**



ungeeicht
 un calibrated
 no calibrado
 non calibrato



SCHIOETZ

1100-3801
 mit gerader Skala
 with straight scale
 con escala recta
 con scala retta

1100-3802
 mit gebogener Skala
 with curved scale
 con escala inclinada
 con scala inclinata

BARRAQUER (COLIBRI)

1100-3803 3,0 cm / 1¹/₄"
 für Kinder
 for children
 para niños
 per bambini

BARRAQUER (COLIBRI)

1100-3804 4,0 cm / 1¹/₂"
 für Erwachsene
 for adults
 para adultos
 per adulti

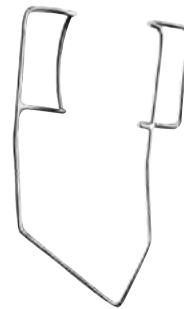

BOWMAN

1100-3805 7,0 cm / 2³/₄"

MELLINGER

1100-3806 5,0 cm / 2"
 für Kinder
 for children
 para niños
 per bambin



MELLINGER

1100-3807 7,0 cm / 2³/₄"
 für Erwachsene
 for adults
 para adultos
 per adulti



MELLINGER-AXENFELD

1100-3808 7,0 cm / 2³/₄"



MELLINGER-AXENFELD

1100-3809 7,0 cm / 2³/₄"



CASTROVIEJO

1100-3810 8,0 cm / 3¹/₈"

Lidinstrumente, Nahtspatel
Lid Instruments, Suturing Spatula
Instrumentos para párpados, Espátula para sutura
Strumenti per palpebra, Spatole per sutura



DESMARRES
1161-2709 13,0 cm / 5¹/₈"

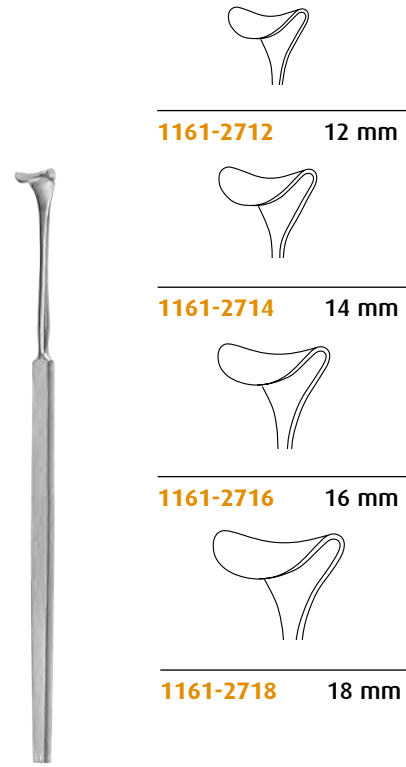

DESMARRES
1161-2712 - 1161-2718 13,0 cm / 5¹/₈"

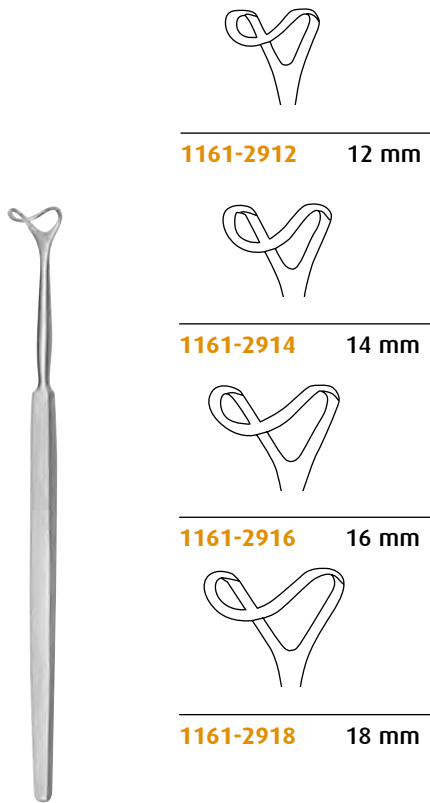

DESMARRES
1161-2912 - 1161-2918 13,0 cm / 5¹/₈"



JAEGER
1161-3011 11,0 cm / 4¹/₂"



FIG.0
1103-0000



FIG.1
1103-0001

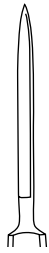

FIG.2
1103-0002



FIG.3
1103-0003

GRAEFE

1103-0000 - 1103-0003

13,0 cm / 5 1/8"



FIG.1
1103-0101



FIG.2
1103-0102

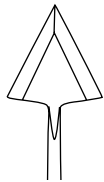

FIG.3
1103-0103



JAEGER-GRIESHABER

1103-0101 - 1103-0103



1103-8101



1103-8102



1103-8103



KNAPP

1103-8101 - 1103-8103

Verschiedene Augenmesser
Varios Eye Knives
Varios cuchillos oculares
Diversi coltelli per oculistica

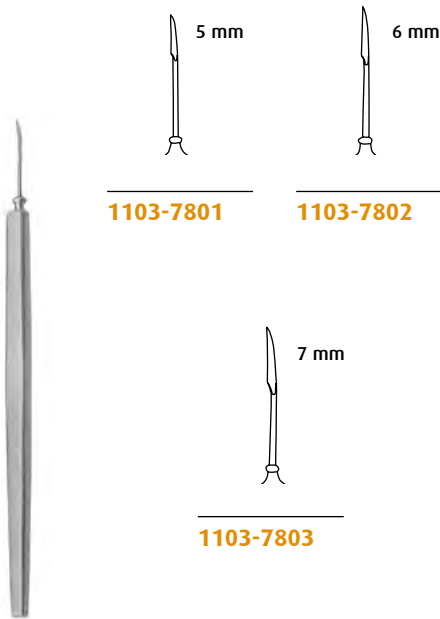

ZIEGLER

1103-7801 - 1103-7803 13,0 cm / 5¹/₈"

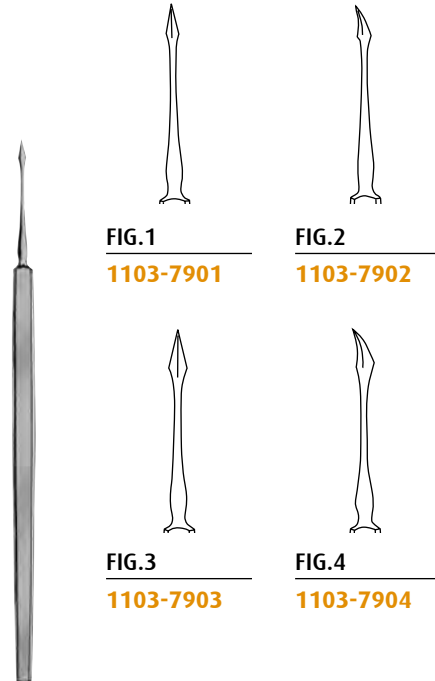

1103-7901 - 1103-7904 13,0 cm / 5¹/₈"

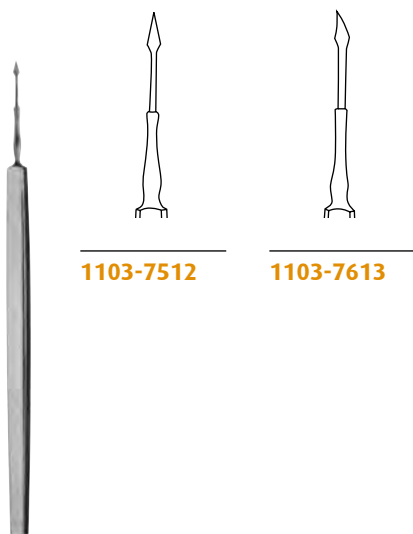

BOWMAN

1103-7512 - 1103-7613 12,0 cm / 4³/₄"

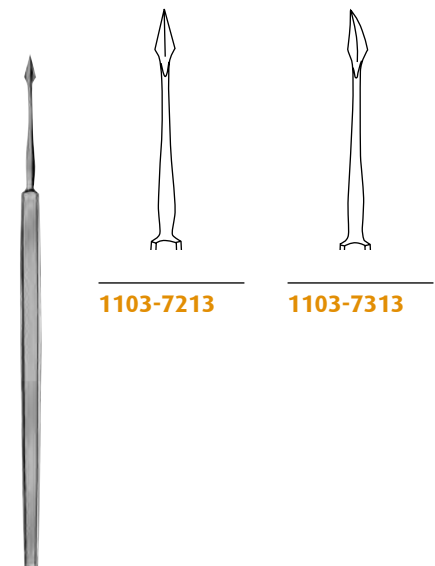

1103-7213 - 1103-7313 13,0 cm / 5¹/₈"



WALTON
 1103-7701



WALTON
 1103-7702



MEYER
 1103-7703

1103-7701 - 1103-7703

12,0 cm / 4³/₄"



STANDARD

1103-8200

Fremdkörperschlinge und Magnet
 in Umsteckhülse

Foreign Body Remover and Magnetic
 Eye Probe, in reversible handle

Lazo para cuerpos extraños e Imã,
 en mango reversible

Laccio per corpi estranei e Calamita,
 in manico reversibile



1103-8201



1103-8202

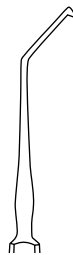

1103-8203

GRAEFE

1103-8201 - 1103-8203

13,0 cm / 5¹/₈"



1161-6501

scharf
 shap
 agudo
 acuto



1161-6601

stumpf
 blunt
 romo
 smusso

GRAEFE

1161-6501 - 1161-6601

12,0 cm / 4³/₄"

Feine Wundhäkchen
Fine Hooklets
Ganchos y Ganchitos finos
Uncini sottile

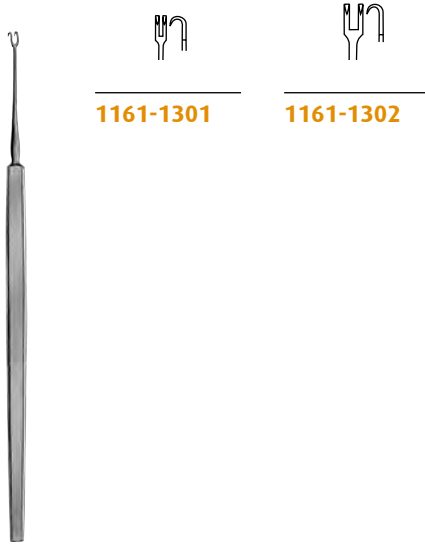

1161-1301

1161-1302

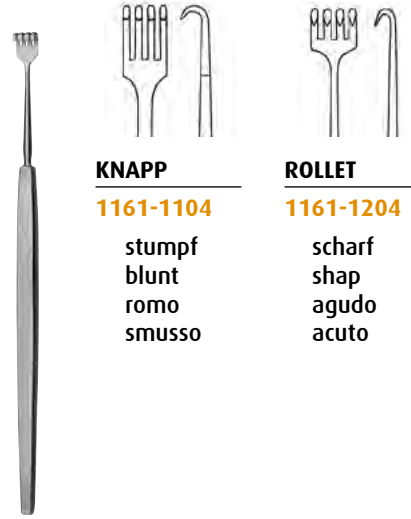

KNAPP

1161-1104

stumpf
blunt
romo
smusso

ROLLET

1161-1204

scharf
shap
agudo
acuto

GUTHRIE

1161-1301 12,0 cm / 4³/₄"
1161-1302 13,0 cm / 5¹/₈"

1161-1104 - 1161-1204 13,0 cm / 5¹/₈"

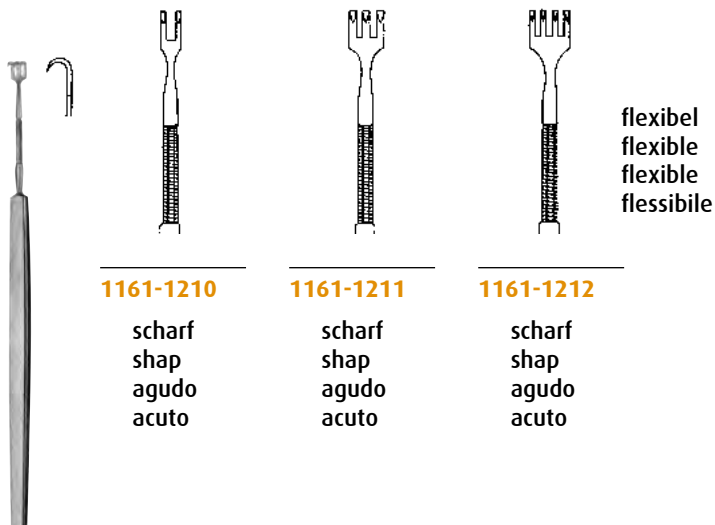

1161-1210

scharf
shap
agudo
acuto

1161-1211

scharf
shap
agudo
acuto

1161-1212

scharf
shap
agudo
acuto

flexibel
flexible
flexible
flessibile

KNAPP-ROLLET

1161-1210 - 1161-1212 13,0 cm / 5¹/₈"

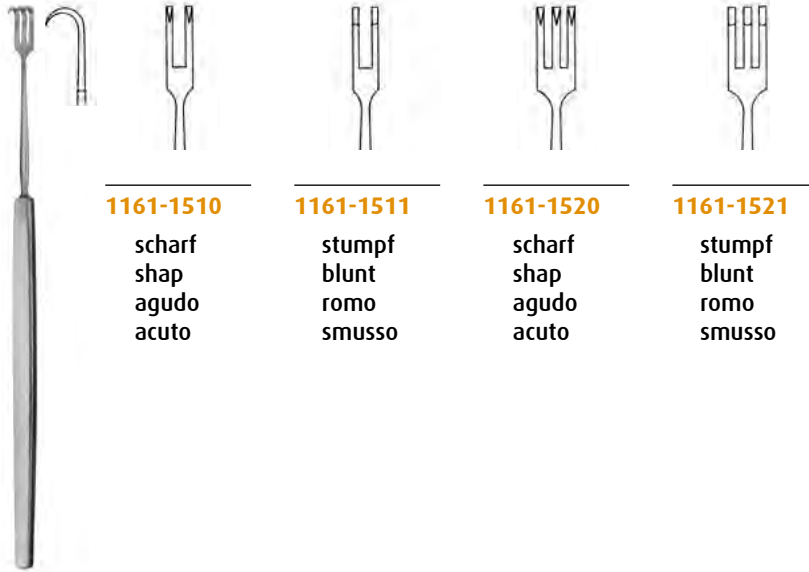

1161-1510

scharf
shap
agudo
acuto

1161-1511

stumpf
blunt
romo
smusso

1161-1520

scharf
shap
agudo
acuto

1161-1521

stumpf
blunt
romo
smusso

AXENFELD

1161-1510 - 1161-1521

15,0 cm / 6"

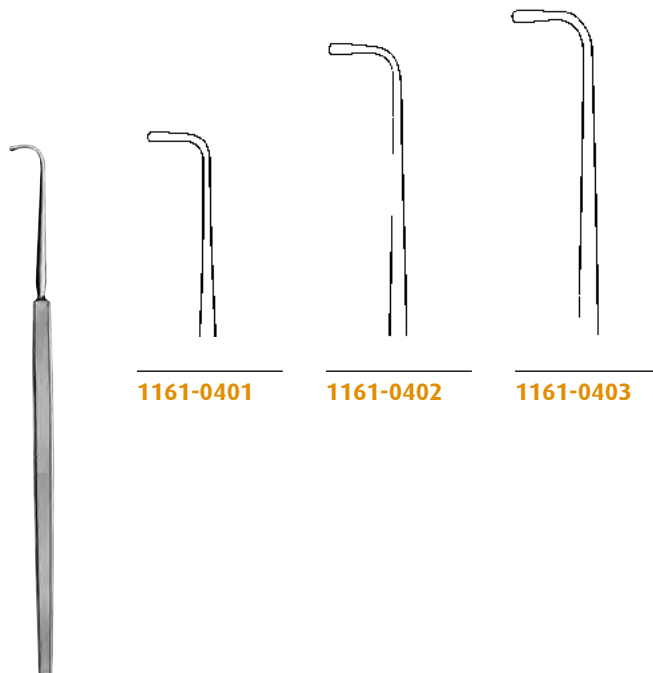

1161-0401

1161-0402

1161-0403

GRAEFE

1161-0401 13,0 cm / 5¹/₈"

1161-0402 14,0 cm / 5¹/₂"

1161-0403 15,0 cm / 6"

Spatelbreite
 Width of spatula
 anchura de espátula
 larghezza della spatola

0,5 mm

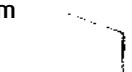

1161-1308 8 mm



1161-1310 10 mm



1161-1312 12 mm

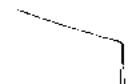

1161-1314 14 mm

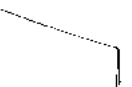

1161-1316 16 mm

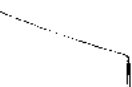

1161-1318 18 mm



CASTROVIEJO-BARRAQUER

1161-1308 - 1161-1318



CASTROVIEJO-BARRAQUER

1161-1408 - 1161-1418

Spatelbreite
 Width of spatula
 anchura de espátula
 larghezza della spatola

1,0 mm



1161-1408 8 mm



1161-1410 10 mm

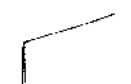

1161-1412 12 mm



1161-1414 14 mm

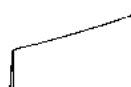

1161-1416 16 mm

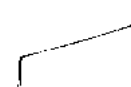

1161-1418 18 mm



ELSCHNIG
 1161-1130

CASTROVIEJO
 1161-1132

CASTROVIEJO
 1161-1140

1161-1130 - 1161-1132 13,0 cm / 5¹/₈"
 1161-1140 14,0 cm / 5¹/₂"

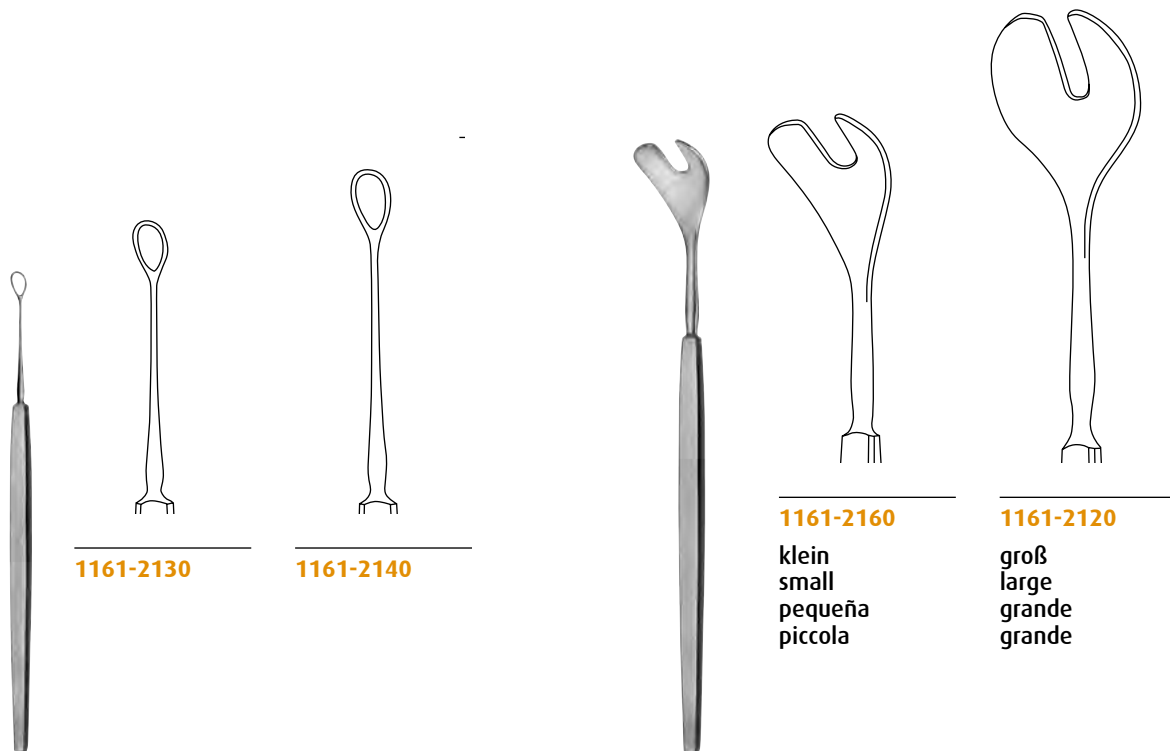

1161-2130

1161-2140

1161-2160
 klein
 small
 pequeña
 piccola

1161-2120
 groß
 large
 grande
 grande

WEBER
 1161-2130 13,0 cm / 5¹/₈"
 1161-2140 14,0 cm / 5¹/₂"

WELLS
 1161-2160 16,0 cm / 6¹/₄"
 1161-2120 20,0 cm / 8"

**Chalationslöffel
Chalazion Currettes
Cucharillas para chalazión
Cucchiai per calazio**

032

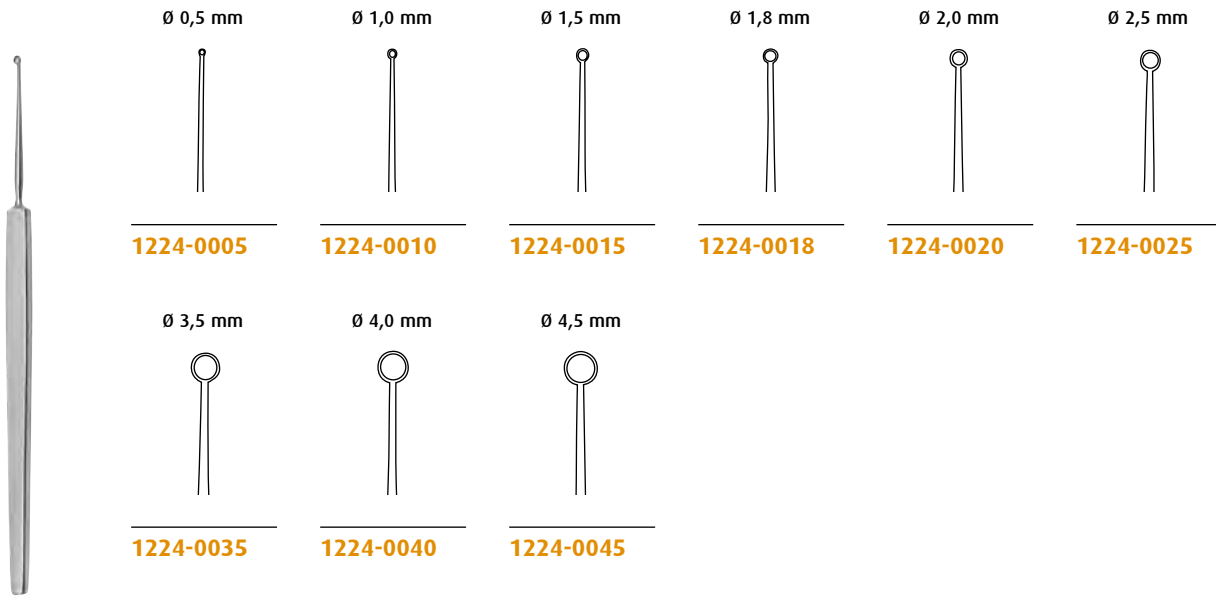

MEYHOEFER

1224-0005 - 1224-0045

13,0 cm / 5¹/₈"

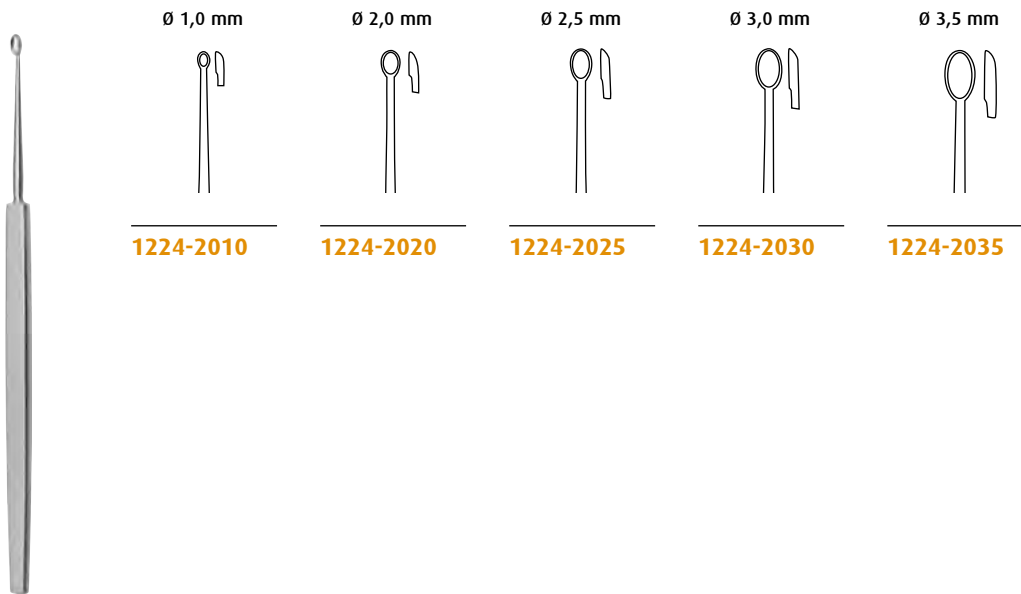

HEBRA

1224-2010 - 1224-2035

13,0 cm / 5¹/₈"

**CASTROVIEJO**

1225-1010 1,0 mm

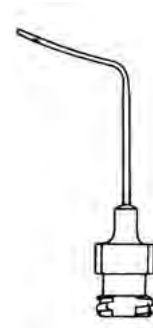
**CASTROVIEJO**

1225-1010 1,5 mm

**LUER LOCK**

1225-3027 27 Gauch

**LUER LOCK**

1225-3030 30 Gauch

**1226-2020**

Griff allein
 Handle only
 Mango suelto
 Manico solo

Ø 1,5 mm

**1226-3015**

Ø 2,0 mm

**1226-3020****ELLIOT****1226-2015**

Satz komplett bestehend aus:

- 1 Griff Art.-Nr. 1226-2020
- 2 Trephinen Ø 1,5 mm, Art.-Nr. 1226-3015
- 2 Trephinen Ø 2,0 mm, Art.-Nr. 1226-3020

Set complete consisting of:

- 1 Handle Ref.-No. 1226-2020
- 2 Trephines Ø 1,5 mm, Ref.-No. 1226-3015
- 2 Trephinen Ø 2,0 mm, Ref.-No. 1226-3020

Juego completo compuesto de.

- 1 Griff Ref.-No. 1226-2020
- 2 Trépanos Ø 1,5 mm, Ref.-No. 1226-3015
- 2 Trépanos Ø 2,0 mm, Ref.-No. 1226-3020

Set completo composto da:

- 1 Manico Ref.-No. 1226-2020
- 2 Trapani Ø 1,5 mm, Ref.-No. 1226-3015
- 2 Trapani Ø 2,0 mm, Ref.-No. 1226-3020

Stanzen, Meißel, Meßzirkel
Punches, Chisels, Measuring Caliper
Pinzas saca-bocados, Cinceles, Compases para medición
Pinze tagliante, Sgorbie, compassi per misurare

032



HOLTH

1402-5802 9,0 cm / 3 1/2"



WEST

1402-5804 16,0 cm / 6 1/4"



WEST

1402-5904 16,0 cm / 6 1/4"



CASTROVIEJO

1220-0206

Meßbereich: 15 mm
 Measuring Range: 15 mm
 Alcance de medición: 15 mm
 Campo di misura: 15 mm



CASTROVIEJO

1220-0208

Meßbereich: 20 mm
 Measuring Range: 20 mm
 Alcance de medición: 20 mm
 Campo di misura: 20 mm

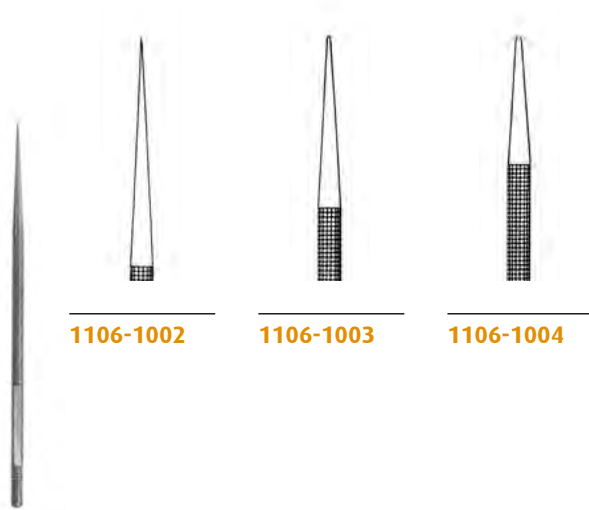

1106-1002

1106-1003

1106-1004

WILDER

1106-1002 - 1106-1004

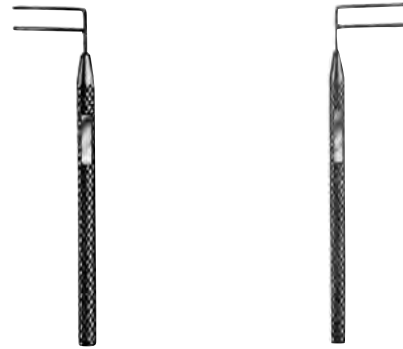

HARMS

1106-1006

links
left
izquierda
sinistra

HARMS

1106-1008

rechts
right
derecha
destra



zylindrisch/geknöpft
cylindrical/pointed
cilindrico/abotonado
cilindrico/abbottonato

Neusilber
German silver
plata alemana
in argerto



zylindrisch
cylindrical
cilindrico
cilindrico

Neusilber
German silver
plata alemana
in argerto



geknöpft
pointed
abotonado
abbottonato

Neusilber
German silver
plata alemana
in argerto

BOWMAN	FIG.	
1106-0870	0/0	0,8 mm
1106-0871	1/1	0,9 mm
1106-0872	2/2	1,1 mm
1106-0873	3/3	1,3 mm
1106-0874	4/4	1,4 mm
1106-0875	5/5	1,5 mm
1106-0876	6/6	1,6 mm
1106-0877	7/7	1,8 mm
1106-0878	8/8	1,9 mm

BOWMAN	FIG.	
1106-0880	00/0	0,7/0,8 mm
1106-0881	0/1	0,8/0,9 mm
1106-0882	1/2	0,9/1,1 mm
1106-0883	2/3	1,1/1,3 mm
1106-0884	3/4	1,3/1,4 mm
1106-0885	4/5	1,4/1,5 mm
1106-0886	5/6	1,5/1,6 mm
1106-0887	6/7	1,6/1,8 mm
1106-0888	7/8	1,8/1,9 mm

BOWMAN	FIG.	
1106-0901	00/0	0,7/0,8 mm
1106-0902	0/1	0,8/0,9 mm
1106-0903	1/2	0,9/1,1 mm
1106-0904	2/3	1,1/1,3 mm
1106-0905	3/4	1,3/1,4 mm
1106-0906	4/5	1,4/1,5 mm
1106-0907	5/6	1,5/1,6 mm
1106-0908	6/7	1,6/1,8 mm
1106-0909	7/8	1,8/1,9 mm

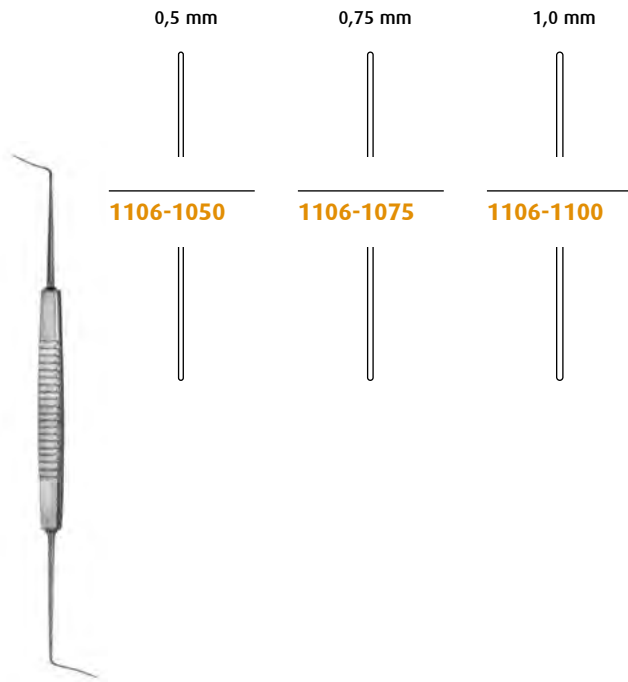

CASTROVIEJO

1106-1050 - 1106-1100



Flachmeißel
Chisel
Cinzel
Scalpello

DIX

1106-1120 12,0 cm / 4³/₄"



Hohlmeißel
Gouge
Gubia
Sgorbie

DIX

1106-1121 12,0 cm / 4³/₄"

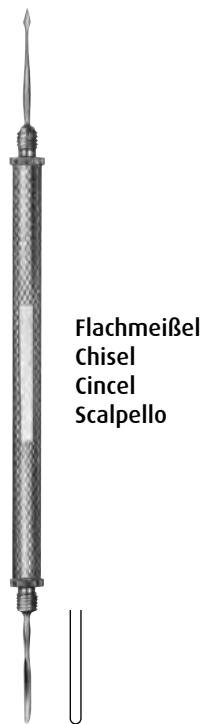

Flachmeißel
Chisel
Cinzel
Scalpello

1106-1413 13,0 cm / 5¹/₈"

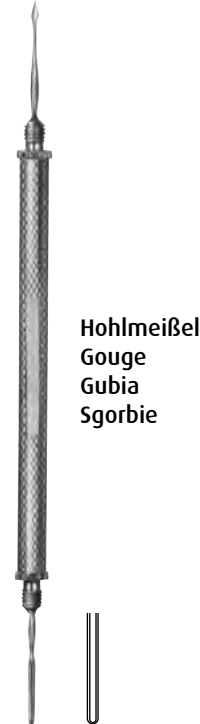

Hohlmeißel
Gouge
Gubia
Sgorbie

1106-1613 13,0 cm / 5¹/₈"

1,0 mm



1130-3210



1130-3310



1131-3110



1131-3210

GRAEFE

1130-3210 - 1131-3210

7,0 cm / 2³/₄"



1130-3601



1130-3602



1130-3603



1131-3601



1131-3602



1131-3603

STEVENS

1130-3601 - 1131-3603

10,5 cm / 4¹/₂"

Irispinzetten, Fixierpinzetten
Iris Forceps, Fixation Forceps
Pinzas para iris, Pinzas de fijación
Pinze per iride, Pinze per fissare



MOD. BONN

1136-8607 7,0 cm / 2³/₄"
1136-8610 10,0 cm / 4"



BISHOP-HARMAN

1227-2408 - 1227-2808 8,5 cm / 3¹/₂"



1227-2408



1227-2508



1227-2608

fein
fine
fina
fina



1227-2808

fein
fine
fina
fina

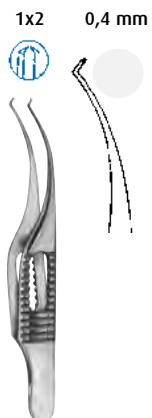

BARRAQUER-KATZIN

1227-2810 7,0 cm / 2³/₄"

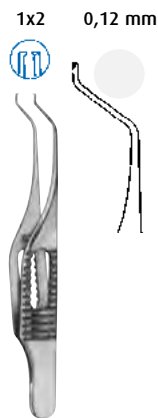

TROUTMAN (COLIBRI)

1227-2812 7,5 cm / 3"



BARRAQUER (COLIBRI)

1227-2814 7,0 cm / 2³/₄"



BARRAQUER-KATZIN (COLIBRI)

1227-2816 7,0 cm / 2³/₄"

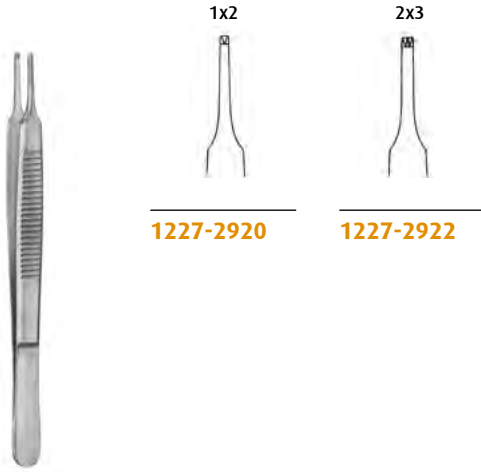



1227-2920

1227-2922

LESTER

1227-2920 - 1227-2922



9,0 cm / 3 1/2"

 <p>gerade straight recta retta</p>	1x2		
			
			Zahnbreite width of teeth ancho de diente larghezza di dente
		1136-0706 1136-0708 1136-0710 1136-0712 1136-0714	0,12 mm 0,3 mm 0,5 mm 1,0 mm 1,5 mm

CASTROVIEJO

1136-0706 - 1136-0714

10,0 cm / 4"

 <p>abgewinkelt angled angulada angolare</p>			
			Zahnbreite width of teeth ancho de diente larghezza di dente
		1336-0805 1336-0810 1336-0815	0,5 mm 1,0 mm 1,5 mm

CASTROVIEJO

1336-0805 - 1336-0815

10,0 cm / 4"

**Nahtpinzetten,
Suture Forceps
Pinzas para sutura
Pinze per sutura**

032

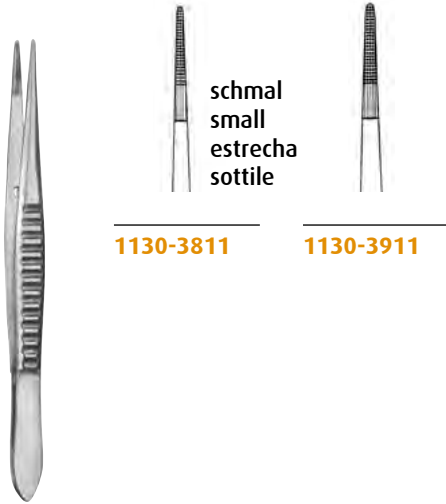

1130-3811

1130-3911

BONACCOLTO

1130-3811 - 1130-3911

10,0 cm / 4"

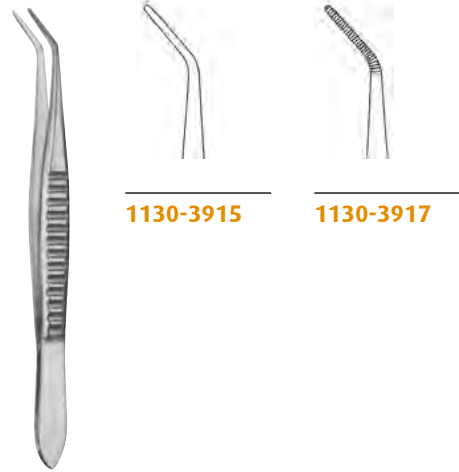

1130-3915

1130-3917

NUGENT

1130-3915 - 1130-3917

10,0 cm / 4"



SNELLEN

1130-3920

10,0 cm / 4"



SNELLEN

1130-3922

10,0 cm / 4"

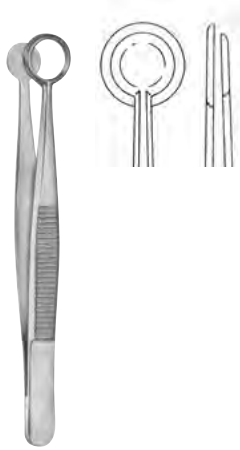

AYER
1130-4019 9,0 cm / 3 1/2"

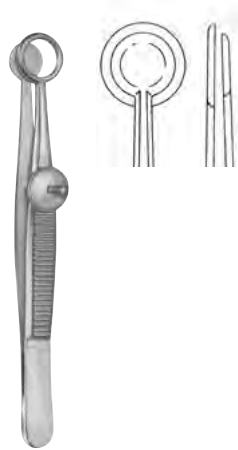

AYER
1130-4021 9,0 cm / 3 1/2"

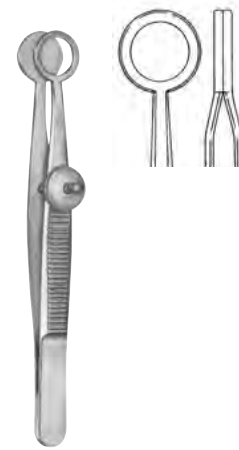

LAMBERT
1130-4023 9,0 cm / 3 1/2"

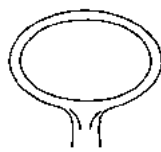

1227-1001

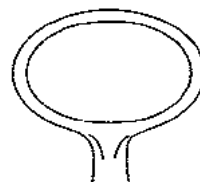

1227-1002

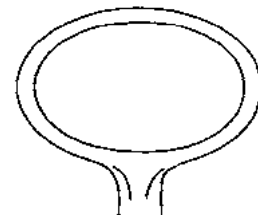

1227-1003

DESMARRES
1227-1001 - 1227-1003 9,0 cm / 3 1/2"



links
 left
 izquierda
 sinistra

KATZIN-BARRAQUER

1116-3505 10,0 cm / 4"



rechts
 right
 derecha
 destro

KATZIN-BARRAQUER

1116-3506 10,0 cm / 4"



1115-9410



1115-9411

1115-9410 - 1115-9411

10,0 cm / 4"



CASTROVIEJO

1115-9703 10,0 cm / 4"



CASTROVIEJO

1115-9704 10,0 cm / 4"



AEBLI

1115-9313 10,0 cm / 4"



1115-9712

1115-9613

1115-9713

NOYES

1115-9712 - 1115-9713

12,0 cm / 4³/₄"

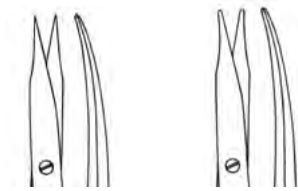

1116-3121

1116-3122

spitz
pointed
aguda
acuto

stumpf
blunt
roma
smusso

WESTCOTT

1116-3121 - 1116-3122

11,0 cm / 4¹/₂"



CASTROVIEJO

1115-9309 9,0 cm / 3¹/₂"

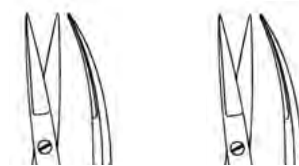

1115-9310

1115-9311

spitz
pointed
aguda
acuto

stumpf
blunt
roma
smusso

CASTROVIEJO

1115-9310 - 1115-9311 10,0 cm / 4"

**Iridektomiescheren,
Iridectomy Scissors
Tijeras para iridectomia
Forbici per iridectomia**



1116-4316



1116-4416

VANNAS

1116-4316 - 1116-4416

8,0 cm / 3¹/₄"



1115-9901



1115-9902



1115-9904

VANNAS-MOD. TÜBINGEN

1115-9901 - 1115-9904

8,5 cm / 3¹/₂"



1115-9805



1115-9807

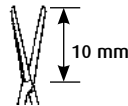

1115-9810

BARRAQUER

1115-9805 - 1115-9810

5,5 cm / 2¹/₄"



links
 left
 izquierda
 sinistra

CASTROVIEJO
 1115-9600 10,0 cm / 4"



rechts
 right
 derecha
 destra

CASTROVIEJO
 1115-9601 10,0 cm / 4"



links
 left
 izquierda
 sinistra

CASTROVIEJO
 1115-9610 11,0 cm / 4 1/2"



rechts
 right
 derecha
 destra

CASTROVIEJO
 1115-9611 11,0 cm / 4 1/2"

034

Otologie
Otology
Otología
Otologia

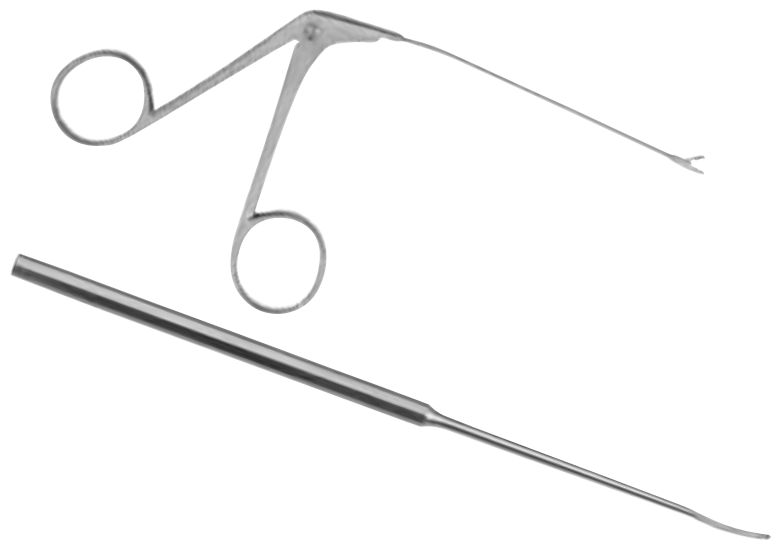



WULLSTEIN
1274-5101 - 1274-5104

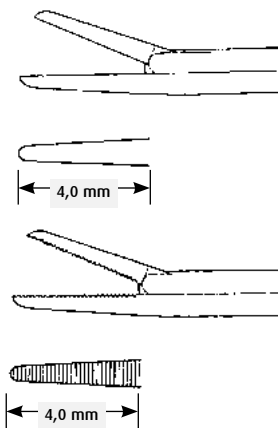

1274-0001 - 1274-0005



1274-5101

4,0 mm x 1,0 mm
 geriefte Maulteile, gerade
 serrated jaws, straight
 bocas estriadas, recta
 morsi scanalati, rette



1274-5102

4,0 mm x 1,0 mm
 geriefte Maulteile, aufgebogen
 serrated jaws, curved up
 bocas estriadas, curva hacia arriba
 morsi scanalati, curve verso l'alto



1274-5103

4,0 mm x 1,0 mm
 geriefte Maulteile, rechts gebogen
 serrated jaws, curved to the right
 bocas estriadas, curva a la derecha
 morsi scanalati, curve verso destra



1274-5104

4,0 mm x 1,0 mm
 geriefte Maulteile, links gebogen
 serrated jaws, curved to the left
 bocas estriadas, curva a la izquierda
 morsi scanalati, curve verso sinistra

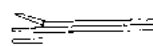

1274-0001

4,0 mm x 0,8 mm
 glatt, gerade
 smooth, straight
 lisa, recta,
 liscia, retta

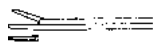

1274-0002

4,0 mm x 0,8 mm
 gerieft, gerade
 serrated, straight
 estriada, recta,
 con scanalura, retta



1274-0003

4,0 mm x 0,8 mm
 aufgebogen, gerieft
 bent upwards, serrated
 curva por arriba, estriada
 curva in alto, con scanallatura

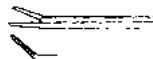

1274-0004

4,0 mm x 0,8 mm
 rechts, gerieft
 righth, serrated
 derecha, estriada
 estra, con scanallatura

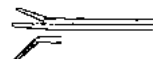

1274-0005

4,0 mm x 0,8 mm
 links, gerieft
 left, serrated
 izquierda, estriada
 sinistra, con scanallatura

Mikro-Ohrzängchen
Micro Ear Forceps
Micro Pinzas auriculares
Micro Pinze auricolari

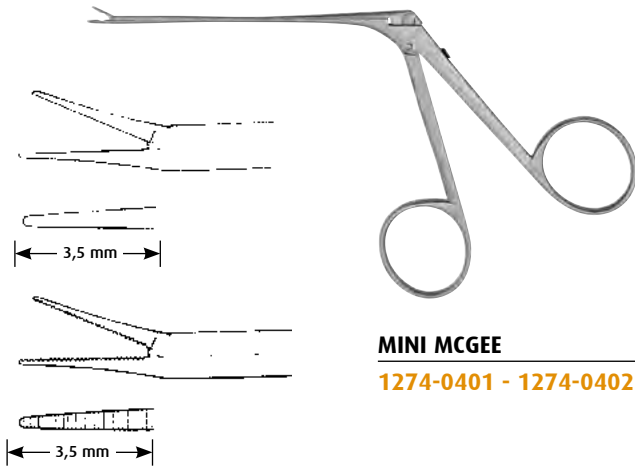

MINI MCGEE

1274-0401 - 1274-0402



1274-0401

3,5 mm x 0,6 mm
 glatt, gerade
 smooth, straight
 lisa, recta
 liscia, retta



1274-0402

3,5 mm x 0,6 mm
 gerieft, gerade
 serrated, straight
 estriada, recta
 con scanalatura, retta

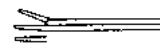
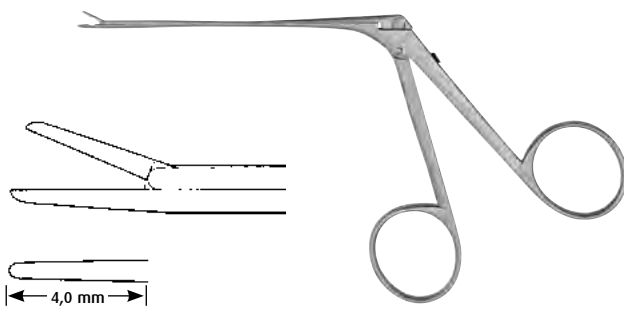

1274-0201

4,0 mm x 0,6 mm
 glatt, gerade
 smooth, straight
 lisa, recta
 liscia, retta

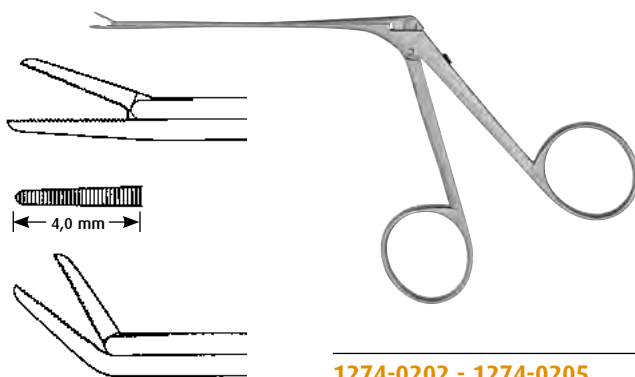

1274-0202 - 1274-0205



1274-0202

4,0 x 0,6 mm
 gerieft, gerade
 serrated, straight
 estriada, recta,
 con scanalura, retta



1274-0203

4,0 x 0,6 mm
 aufgebogen, gerieft
 bent upwards, serrated
 curva por arriba, estriada
 curva in alto, con scanallatura



1274-0204

4,0 x 0,6 mm
 rechts, gerieft
 righth, serrated
 derrecha, estriada
 estra, con scanallatura

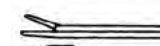

1274-0205

4,0 x 0,6 mm
 links, gerieft
 left, serrated
 izquierda, estriada
 sinistra, con scanallatura

1,0 x 0,9 mm
 Löffel
 cup
 cucharilla
 cucchiaio

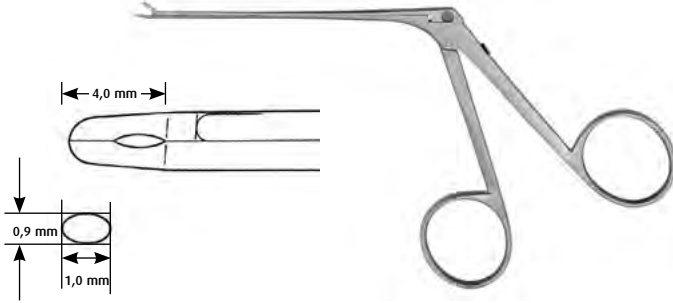

1274-0601 - 1274-0604

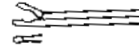

4,0 mm
 gerade
 straight
 recta
 retta

1274-0601



4,0 mm
 aufgebogen
 curved up
 curva por arriba
 curva in alto

1274-0602

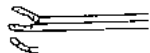

4,0 mm
 rechts
 right
 derecha
 destra

1274-0603

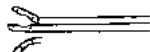

4,0 mm
 links
 left
 izquierda
 sinistra

1274-0604

0,6 x 0,5 mm
 Löffel
 cup
 cucharilla
 cucchiaio

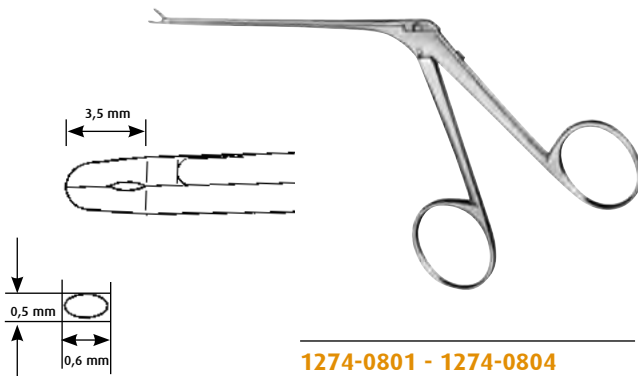

1274-0801 - 1274-0804

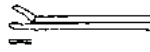

3,5 mm
 gerade
 straight
 recta
 retta

1274-0801

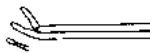

3,5 mm
 aufgebogen
 curved up
 curva por arriba
 curva in alto

1274-0802

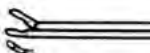

3,5 mm
 rechts
 right
 derecha
 destra

1274-0803



3,5 mm
 links
 left
 izquierda
 sinistra

1274-0804

Mikro-Ohrscheren
Micro Ear Scissors
Micro Tijeras auriculares
Micro Forbici auricolari

sehr fein
 very fine
 muy fina
 molto delicata

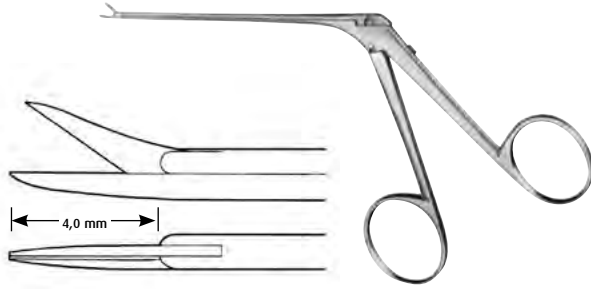

BELLUCCI
 1274-1100 - 1274-1106

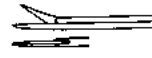

gerade
 straight
 recta,
 retta

1274-1100



aufgebogen
 curved up
 curva por arriba
 curva in alto

1274-1102

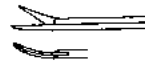

rechts
 right
 derecha
 destra

1274-1104



links
 left
 izquierda
 sinistra

1274-1106

0,8 mm
 Schaft
 shaft
 vastago
 gambo

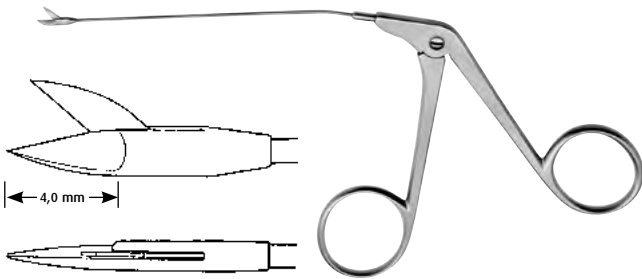

WULLSTEIN
 1274-5501 - 1274-5504

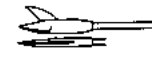

gerade
 straight
 recta
 retta

1274-5501



aufgebogen
 curved up
 curva por arriba
 curva in alto

1274-5502

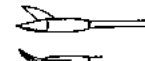

rechts
 right
 derecha
 destra

1274-5503



links
 left
 izquierda
 sinistra

1274-5504

Mikro-Ohrzängchen
Micro Ear Forceps
Micro Pinzas auriculares
Micro Pinze auricolari

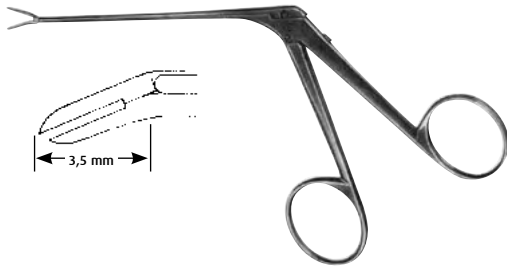

MC GEE

1274-2201 - 1274-2202

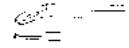

1274-2201

3,5 x 0,8 mm
 abgebogen
 curved downward
 curva por abajo
 curva in basso

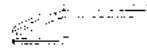

1274-2202

6,0 x 0,8 mm
 abgebogen
 curved downward
 curva por abajo
 curva in basso



WULLSTEIN

1274-5301 - 1274-5304



1274-5301

runde Maulteile, ø 1,0 mm, gerade
 round cup jaws, ø 1,0 mm, straight
 copas redondas, ø 1,0 mm, recta
 morsi rotondi, ø 1,0 mm, retta



1274-5302

runde Maulteile, ø 1,0 mm, aufgebogen
 round cup jaws, ø 1,0 mm, curved up
 copas redondas, ø 1,0 mm, curva hacia arriba
 morsi rotondi, ø 1,0 mm, curve verso l'alto



1274-5303

runde Maulteile, ø 1,0 mm, rechts gebogen
 round cup jaws, ø 1,0 mm, curved to the right
 copas redondas, ø 1,0 mm, curva a la derecha
 morsi rotondi, ø 1,0 mm, curve verso destra



1274-5304

runde Maulteile, ø 1,0 mm, links gebogen
 round cup jaws, ø 1,0 mm, curved to the left
 copas redondas, ø 1,0 mm, curva a la izquierda
 morsi rotondi, ø 1,0 mm, curve verso sinistra

Hammerkopfzängchen
Malleus Nipper
Pinza para cabezal del malèolo
Pinz per testa del martelletto

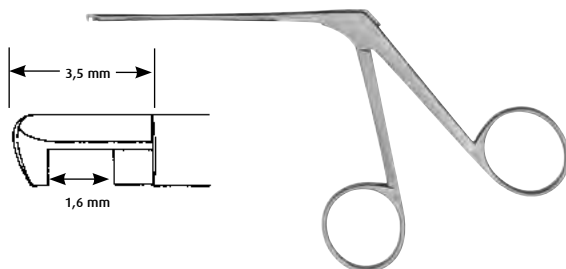

HOUSE-DIETER

1274-2602 - 1274-2601

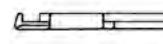

1274-2602

3,5 x 1,6 mm
 oben schneidend
 up-cutting
 corte arriba
 tagliente in alto

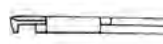

1274-2601

3,5 x 1,6 mm
 unten schneidend
 down-cutting
 corte abajo
 tagliente in basso

Mikro-Ohrzängchen
Micro Ear Forceps
Micro Pinzas auriculares
Micro Pinze auricolari

Hammerkopfzängchen
 Malleus Nipper
 Pinza para cabezal del malèolo
 Pinz per testa del martelletto

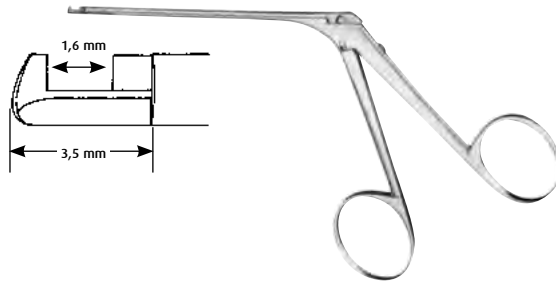

HOUSE-DIETER

1274-2604 - 1274-2603

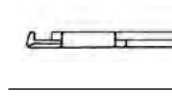

3,5 mm x 1,6 mm
 rechts schneidend
 right-cutting
 corte derecho
 tagliente a destra

1274-2604

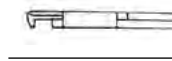

3,5 mm x 1,6 mm
 links schneidend
 left-cutting
 corte izquierdo
 tagliente a sinistra

1274-2603

Einführungszängchen
 Introducing Forceps
 Pinza para introducir
 Pinza per introduzione

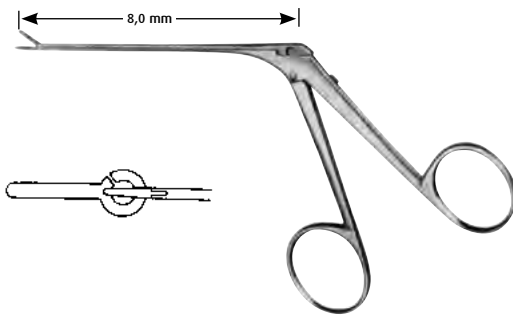

FULLER

1274-2801



WULLSTEIN

1274-5305 - 1274-5308



ovale Maulteile, ø 1,0 mm, gerade
 oval cup jaws, ø 1,0 mm, straight
 copas ovales, ø 1,0 mm, recta
 morsi ovale, ø 1,0 mm, retta

1274-5305



ovale Maulteile, ø 1,0 mm, aufgebogen
 oval cup jaws, ø 1,0 mm, curved up
 copas ovales, ø 1,0 mm, curva hacia arriba
 morsi ovali, ø 1,0 mm, curve verso l'alto

1274-5306



ovale Maulteile, ø 1,0 mm, rechts gebogen
 oval cup jaws, ø 1,0 mm, curved to the right
 copas ovales, ø 1,0 mm, curva a la derecha
 morsi ovali, ø 1,0 mm, curve verso destra

1274-5307



ovale Maulteile, ø 1,0 mm, links gebogen
 oval cup jaws, ø 1,0 mm, curved to the left
 copas ovales, ø 1,0 mm, curva a la izquierda
 morsi ovali, ø 1,0 mm, curve verso sinistra

1274-5308



SCHUKNECHT

1275-0202 16,0 cm / 6¹/₄"

Rollenmesser
 Rotary Knife
 Cuchillo redondo
 Coltello rotondo



SCHUKNECHT

1275-0012 16,0 cm / 6¹/₄"

Sichelmesser
 Sickle Knife
 Cuchillos de hoz
 Coltello falcato come sinechia



WULLSTEIN

1275-0003 16,0 cm / 6¹/₄"

Sichelmesser
 Sickle Knife
 Cuchillos de hoz
 Coltello falcato come sinechia



TABB

1275-0004 16,0 cm / 6¹/₄"

Schleimhautmesser
 Mucosa Knife
 Cuchillo para mucosa
 Coltello per mucosa



PLESTER

1275-0101 16,0 cm / 6¹/₄"

Lappenmesser
 Flap Knife
 Cuchillo para lóbulos
 Coltello per lobi

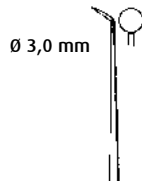

FIG. 1
1275-0302

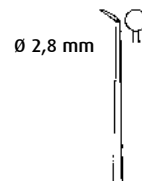

FIG. 2
1275-0303

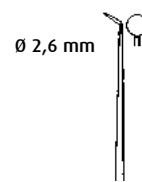

FIG. 3
1255-0304

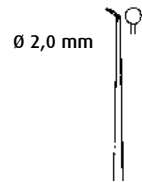

FIG. 4
1275-0306

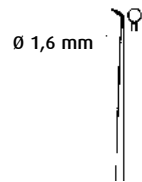

FIG. 5
1275-0307

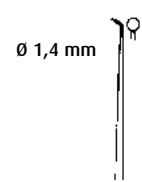

FIG. 6
1275-0308

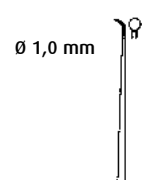

FIG. 7
1275-0309

ROSEN

1275-0302 - 1275-0309 16,0 cm / 6¹/₄"

Rundschnittmesser
 Circular Cut Knives
 Cuchillos para cortes redondos
 coltelli circolari

Mikro-Ohrnadeln, Mikro-Ohrhäkchen
Micro Ear Needles, Micro Ear Hooks
Micro Aguja auriculares, Mirco Ganchitos auriculares
Micro Aghi auricolari, Micro Uncini auricolari

034



BARBARA
1275-1001



BARBARA
1275-1002



BARBARA
1275-1003



ROSEN
1275-1004



25°

BARBARA
1275-1005 0,3 mm
1275-1006 0,6 mm
1275-1007 1,0 mm



45°

BARBARA
1275-1008 0,3 mm
1275-1009 0,6 mm
1275-1010 1,0 mm
1275-1011 1,2 mm
1275-1018 1,5 mm
1275-1019 2,0 mm
1275-1020 2,5 mm



90°

BARBARA
1275-1012 0,3 mm
1275-1013 0,6 mm
1275-1015 1,0 mm
1275-1025 1,2 mm
1275-1026 1,5 mm
1275-1027 2,0 mm
1275-1028 2,5 mm



BARBARA
1275-1021 0,5 mm
1275-1016 1,0 mm



1275-1001 - 1275-1016 16,0 cm / 6¹/₄"



1275-1101	0,3 mm
1275-1102	0,6 mm
1275-1103	1,0 mm

1275-1111	0,3 mm
1275-1112	0,6 mm
1275-1113	1,0 mm

MC GEE

1275-1302	0,5 mm
1275-1303	1,0 mm



MC GEE

1275-1312	0,5 mm
1275-1313	1,0 mm

BARBARA

1275-1401	
------------------	--

ROSEN

1275-1501	
------------------	--

1275-1101 - 1275-1501 15,5 cm / 6"

Mikro-Ohrhäkchen
Micro Ear Hooks
Micro Ganchitos auriculares
Micro Uncini auricolari



1275-1711 0,3 mm



1275-1712 0,6 mm



1275-1713 1,0 mm



1275-1731 0,3 mm



1275-1732 0,6 mm



1275-1733 1,0 mm

1275-1711 - 1275-1733 15,5 cm / 6"

45°

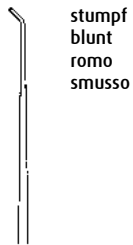

stumpf
blunt
romo
smusso

SHEA

1275-1745 2,0 mm

Sondierhaken
Exploring Hook
Ganchito explorador
Uncino di sondaggio

90°

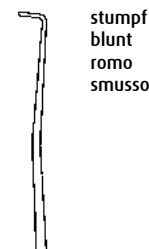

stumpf
blunt
romo
smusso

AUSTIN

1275-1790 3,0 mm

Attikusdissektor
Attic Dissector
Disecador para el ático
Dissettore per l'attico



1275-1791



nach rechts abgewinkelt
 angled to right
 angulada por derecha
 angulata a destra



1275-1792

nach links abgewinkelt
 angled to left
 angulada por izquierda
 angulata a sinistra



1275-1793

nach rechts abgewinkelt
 angled to right
 angulada por derecha
 angulata a destra



1275-1794

nach links abgewinkelt
 angled to left
 angulada por izquierda
 angulata a sinistra

FISCH

1275-1791 - 1275-1794

15,5 cm / 6"



2,0 mm

ROSEN

1275-0404 15,5 cm / 6"

Mikro-Ohrraspatorium
 Micro Ear Periosteal Elevator
 Micro legra auricular
 Micro Raspatore auricolare



1275-0635

3,5 mm



1275-0640

4,0 mm



1275-0645

4,5 mm



1275-0650

5,0 mm

HOUSE

1275-0635 - 1275-0650 15,5 cm / 6"

Mikro-Messsonde
 Micro Measuring Rod
 Micro sonda para medir
 Micro Sonda per misurare

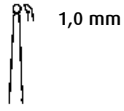

1,0 mm

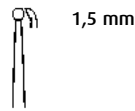

1,5 mm

1275-2201

1275-2202

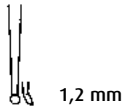

1,2 mm



1,8 mm

HOUSE

1275-2201 - 1275-2202

15,0 cm / 6"

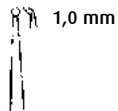

1,0 mm

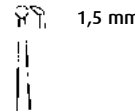

1,5 mm

1275-2203

1275-2204

stark abgewinkelt
 strong angled
 angulada fuerte
 angulata forte

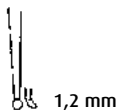

1,2 mm



1,8 mm

HOUSE

1275-2203 - 1275-2204

15,0 cm / 6"



HARTMANN Fig. 0-2
1271-0400 3,6 cm / 1 1/2"

Ohrspekula, Satz für Kinder
Ear Specula, set for children
Spéculums auriculares, juego para niños
Specoli auricolari, set per bambini

Fig. 0
1271-0403 3,0 mm

Fig. 1
1271-0404 4,0 mm

Fig. 2
1271-0405 5,0 mm

Fig. 3
1271-0406 6,0 mm

Fig. 4
1271-0408 7,5 mm



HARTMANN Fig. 2-4
1271-0402 3,6 cm / 1 1/2"

HARTMANN Fig. 1-4
1271-0500 3,6 cm / 1 1/2"
Ohrspekula, Satz für Erwachsene
Ear Specula, set for adults
Spéculums auriculares, juego para adultos
Specoli auricolari, set per adulti



TOYNBEE Fig. 2-4
1271-0801 3,6 cm / 1 1/2"

TOYNBEE Fig. 1-4
1271-0800 3,6 cm / 1 1/2"

Ohrspekula, Satz für Erwachsene
Ear Specula, set for adults
Spéculums auriculares, juego para adultos
Specoli auricolari, set per adulti



schwarz
black
negro
nero

FARRIOR Fig. 1-7
1271-0810 3,6 cm / 1 1/2"

Ohrspekula, Satz bestehend aus 7 Stück
Ear Specula, set consisting of 7 pieces
Spéculums auriculares, juego consiste de 7 piezas
Specoli auricolari, set composto di 7 pezzi

Fig. 1
1271-0804 4,0 mm

Fig. 2
1271-0805 5,0 mm

Fig. 3
1271-0806 6,0 mm

Fig. 4
1271-0807 7,5 mm

Fig. 1
1271-0811 5,5 mm

Fig. 3
1271-0813 7,5 mm

Fig. 5
1271-0815 9,5 mm

Fig. 7
1271-0817 11,5 mm

Fig. 2
1271-0812 6,5 mm

Fig. 4
1271-0814 8,5 mm

Fig. 6
1271-0816 10,5 mm

Ohrspekula
Ear Specula
Espéculos auriculares
Specoli auricolari



oval, schwarz
 oval, black
 ovalado, negro
 ovale, nero

ZÖLLNER Fig. 1-6
1271-0100 3,8 cm / 1 1/2"

Ohrspekula, Satz bestehend aus 6 Stück
 Ear Specula, set consisting of 6 pieces
 Spéculums auriculares, juego consiste de 6 piezas
 Specoli auricolari, set composto di 6 pezzi

Fig. 1
1271-0101 5,5 x 6,5 mm

Fig. 2
1271-0102 6,5 x 7,5 mm

Fig. 3
1271-0103 7,5 x 8,5 mm

Fig. 4
1271-0104 8,5 x 9,5 mm

Fig. 5
1271-0105 9,5 x 10,5 mm

Fig. 6
1271-0106 10,5 x 11,5 mm

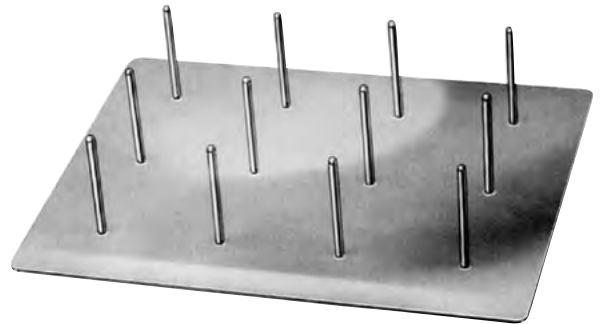

1271-1099
 Ohrspekulaständer
 Ear Specula Storage Rack
 Soporte para espéculos auriculares
 Supporto per specoli auricolari



BOUCHERON Fig. 1-4
1271-0604

Ohrspekula, Satz bestehend aus 4 Stück
 Ear Specula, set consisting of 4 pieces
 Spéculums auriculares, juego consiste de 4 piezas
 Specoli auricolari, set composto di 4 pezzi

Fig. 1
1271-0605 4,2 mm

Fig. 2
1271-0606 5,2 mm

Fig. 3
1211-0607 6,2 mm

Fig. 4
1271-0606 7,2 mm

ALUMINIUM

1270-0500

Alu-Stimmgabel-Satz komplett im Etui bestehend aus 1270-0502 bis 1270-0506

Set of Tuning Forks (Alu) complete in case consisting of 1270-0502 till 1270-0506

Juego de diapasones (aluminio) completo en estuche compuesto de 1270-0502 hasta 1270-0506

Set da diapason (alluminio) completo in astuccio composto da 1270-0502 fino a 1270-0506



ALUMINIUM
1270-0502 c128

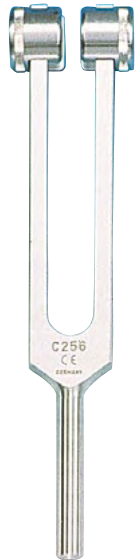

ALUMINIUM
1250-0503 C256



ALUMINIUM
1270-0503 C512



ALUMINIUM
1270-0505 C1024



ALUMINIUM
1270-0506 C2048

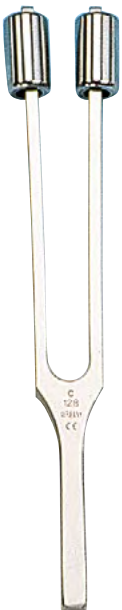

HARTMANN
1270-0004 c128



HARTMANN
1270-0005 c1256



HARTMANN
1270-0103 c2512



HARTMANN
1270-0104 c31024



HARTMANN
1270-0105 c42048



HARTMANN

1270-0700

Stimmgabel-Satz komplett im Etui bestehend aus 1270-0004 bis 1270-0105
Set of Tuning forks complete in case consisting of 1270-0004 till 1270-0105
Juego de diapasones completo en estuche compuesto de 1270-0004 hasta 1270-0105
Set da diapason completo in astuccio composito da 1270-0004 fino a 1270-0105



HARTMANN
1270-0101 c128



HARTMANN
1270-0102 c1256



HARTMANN
1270-0507 c54096

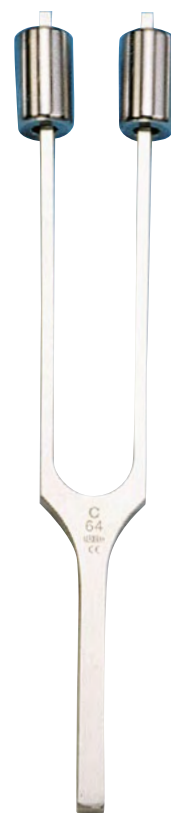

HARTMANN
1270-0503 c64



LUCAE
1270-0401 c128



LUCAE
1270-0402 c1256



LUCAE
1270-0403 c2512



LUCAE
1270-0404 c31024



LUCAE
1270-0405 c42048



LUCAE
1270-0406 c54096

verschiebbar bis h 240
movable up to h 240
regulable hasta h 240
regolabile fino a h 240

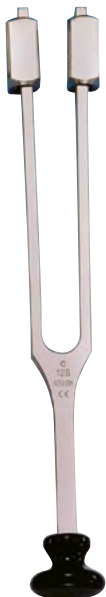

LUCAE
1270-1201 c128

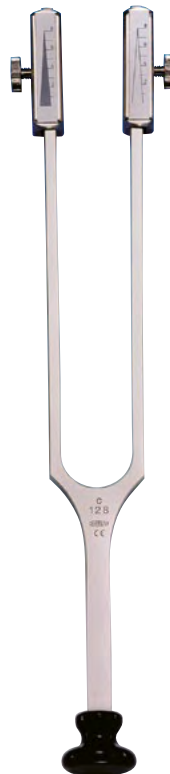

RYDEL-SEIFFERT
1270-0801 C64/c128

auch für Neurologie
also for neurology
para neurologia
per neurologia

mit Dämpfer = C64
with Dampers = C64
con sordinas = C64
con sordine = C64

ohne Dämpfer = c128
without dampers = c128
sin sordinas = c128
senza sordine = c128

ALUMINIUM-STIMMGABEL mit Perkussionshammer,
Nadelrad, Nadel und Pinsel im Etui

ALUMINIUM-Tuning Fork with Percussion hammer,
pin wheel, needle and brush in case

ALUMINIO-Diapason con martillo para percusion, rueda
de agujas, aguja y pincel en festuche

ALLUMINIO-Diapason con martello di riflesso, ruota
per l'ago, ago e pennello in astuccio



NEURO
1270-1800

Stimmgabeln, Lärmtrommel
Tuning Forks, Noise Apparatus
Diapasones, Ensordecdor
Diapason, Assordatore

034

verschiebbar bis g194
movable up to g194
regulable hasta g194
regolabile fino a g194



KÖNIG

1270-1501 A109



1270-1001 a1440



BARANY

1270-2000

1270-2001
Ohrolive, allein
Ear piece, only
Oliva, suelta
Oliva, sola



Fig. 1

1270-3101



Fig. 2

1270-3102



Fig. 3

1270-3103

HARTMANN

1270-3101 - 1270-3103

15,0 cm / 6"



offenes Ende
 open tip
 punta abierta
 punta aperta

KRAUSE

1273-5116

18,5 cm / 7¹/₄"



geschlossenes Ende
 closed tip
 punta cerrada
 punta chiusa

KRAUSE-VOSS

1273-5316

18,5 cm / 7¹/₄"

Schnürerschlingen, Bündel mit 12 Stück
 Snare loops, bundle with 12 pieces
 Asas de alambre, manajo de 12 piezas
 Lacci di filo di metallo, manello die 12 pezzi



7,5 cm

1273-5912 Ø 0,20 mm
 1273-5913 Ø 0,25 mm
 1273-5914 Ø 0,30 mm



TROELTSCH (WILDE)
1134-0112 12,0 cm / 4³/₄"



TROELTSCH (WILDE)
1134-0312 12,0 cm / 4³/₄"



LUCAE
1134-0714 14,0 cm / 5¹/₂"



LUCAE
1134-0716 16,0 cm / 6¹/₄"

**TILLEY**

1266-0113 14,0 cm / 5¹/₂"

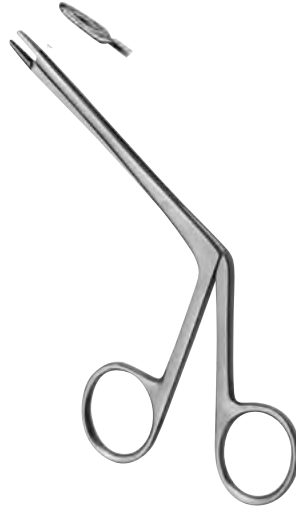
**LITTAUER**

1266-0213 12,0 cm / 4³/₄"



feines Modell
fine model
modelo fino
modello fino

HARTMANN

1272-0612 12,0 cm / 4³/₄"

**HARTMANN**

1272-0814 14,0 cm / 5¹/₂"

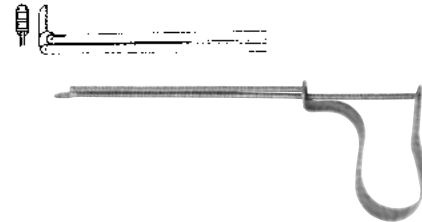
**QUIRE**

1272-0009 10,0 cm / 4³/₈"

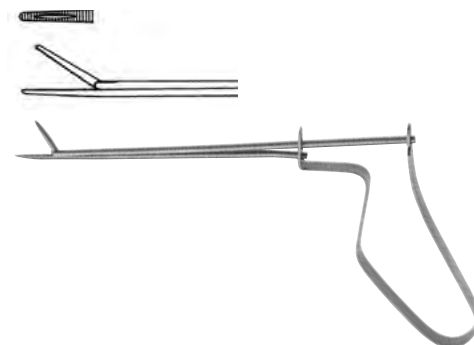
**BUCK**

1272-0209 11,0 cm / 4³/₈"

Ohrpolypenzangen
 Ear Polypus Forceps
 Pinzas para pólipos auriculares
 Pinze per polipi auricolari

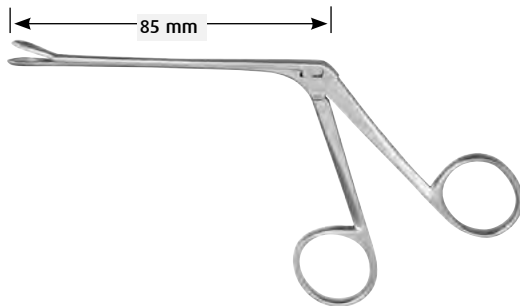
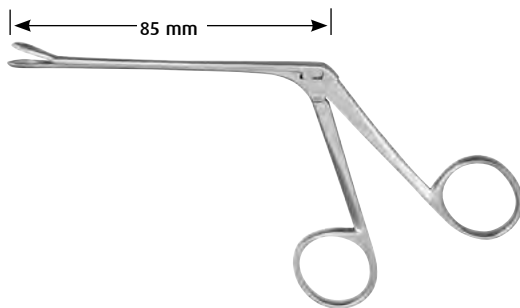

HARTMANN-WULLSTEIN
1272-1101 8,5 cm

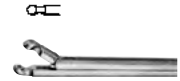

HARTMANN-WULLSTEIN
1272-2501 Ø 1,0 mm / 8,5 cm



HARTMANN
1272-1408 8,5 cm



HARTMANN
1272-1708 8,5 cm

HARTMANN
1272-1414 14,0 cm / 5 1/2"

Schaftlänge 140 mm
 Shaft length 140 mm
 longitud del vástago 140 mm
 lunghezza del gambo 140 mm

HARTMANN
1272-1714 14,0 cm / 5 1/2"

Schaftlänge 140 mm
 Shaft length 140 mm
 longitud del vástago 140 mm
 lunghezza del gambo 140 mm

HARTMANN
1272-1416 16,0 cm / 6 1/4"

Schaftlänge 160 mm
 Shaft length 160 mm
 longitud del vástago 160 mm
 lunghezza del gambo 160 mm

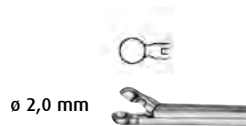

Ø 2,0 mm
HARTMANN
1272-2601 8,5 cm / 3 1/4"

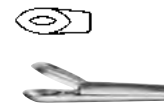

STRÜMPEL
1272-3008 8,5 cm / 3 1/4"



Ø 2,5 mm
HARTMANN
1272-2602 8,5 cm / 3 1/4"

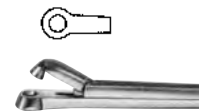

HARTMANN-HOFFMANN
1272-2620 8,5 cm / 3 1/4"



Ø 3,0 mm
HARTMANN
1272-2603 8,5 cm / 3 1/4"



||
 1400-0015 1,5 mm

∩
 1400-0022 2,0 mm

∩
 1400-0030 3,0 mm

CITELLI

1400-0015 - 1400-0030 17,0 cm / 6³/₄"



1 mm Schnitt
 1 mm cut
 corte 1 mm
 taglio 1 mm

BEYER

1400-0210 14,0 cm / 5¹/₂"



2 mm Schnitt
 2 mm cut
 corte 2 mm
 taglio 2 mm

BEYER

1400-0218 19,0 cm / 7¹/₂"

Ohrküretten
 Ear Cures
 Curetas auriculares
 Curette auricolari

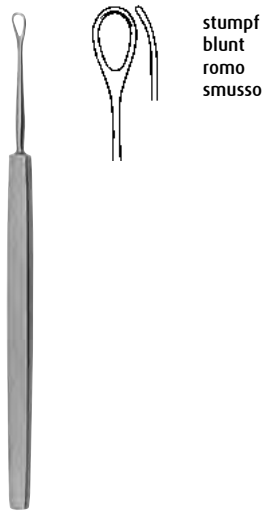

stumpf
 blunt
 romo
 smusso

LANGENBECK

1271-5513 13,0 cm / 5"



1271-6001



1271-6002

SHAPLEIGH

1271-6001 - 1271-6002 15,0 cm / 6"



gerade stumpf
 straight blunt
 recto romo
 retto smusso



gerade scharf
 straight sharp
 recto agudo
 retto acuto



FIG. 00

1271-5002



FIG. 0

1271-5003



FIG. 1

1271-5004



FIG. 2

1271-5005



FIG. 3

1271-5006



FIG. 4

1271-5007



FIG. 5

1271-5008



FIG. 00

1271-5202



FIG. 0

1271-5203



FIG. 1

1271-5204



FIG. 2

1271-5205



FIG. 3

1271-5206



FIG. 4

1271-5207



FIG. 5

1271-5208

BUCK

1271-5002 - 1271-5208



gebogen stumpf
 curved blunt
 curva romo
 curvo smusso

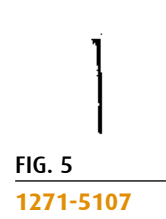
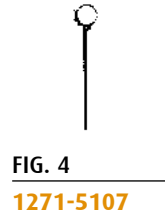
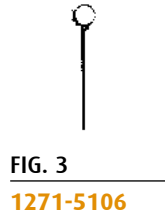
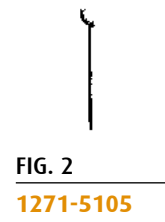
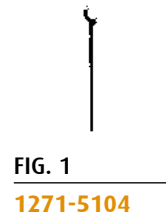
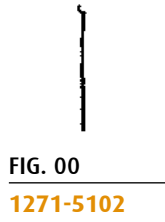

gebogen scharf
 curved sharp
 curva agudo
 curvo acuto

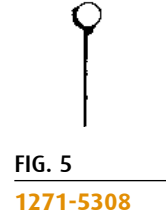
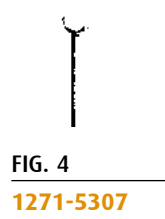
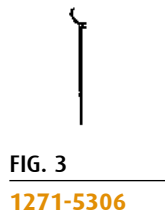
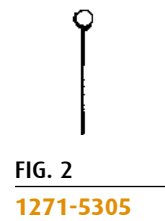
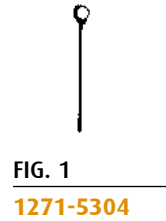
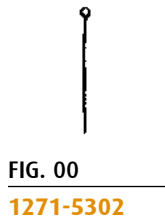

BUCK
1271-5102 - 1271-5308



JANSEN
1241-6215 15,0 cm / 6"

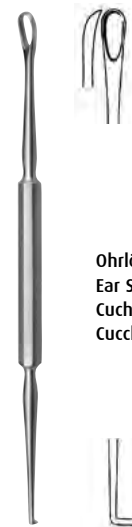

Ohrlöffel und Hähchen
 Ear Scoop/Hook
 Cucharilla/ganchito auricular
 Cucchiaino auricolare

GROSS
1271-6512 12,0 cm / 4³/₄"



klein
small
pequeño
piccolo

1271-5601



mittel
medium
mediano
medio

1271-5602



groß
large
grande
grande

1271-5603

BILLEAU

1271-5601 - 1271-5603

16,0 cm / 6¹/₄"

Ohrschlinge
Ear Loop
Asa auricular
Ansa auricolare



Fig.0

1271-5800



Fig.1

1271-5801



Fig.2

1271-5802

WEBER-LOCH

1271-5800 - 1271-5802

14,5 cm / 5³/₄"

Ohrschlinge
Ear Loop
Asa auricular
Ansa auricolare



MOLDENHAUER

1271-6916

16,5 cm / 6¹/₂"

Fremdkörperhebel
Foreign Body Lever
Elevador para cuerpos extraños
Leva per corpi estranei



ZAUFAL

1271-6716

16,0 cm / 6¹/₂"

Fremdkörperhebel
Foreign Body Lever
Elevador para cuerpos extraños
Leva per corpi estranei



HARTMANN

1271-7516

16,0 cm / 6"

Ohrhäkchen
Ear Hooklet
Ganchito auricular
Uncino auricolare

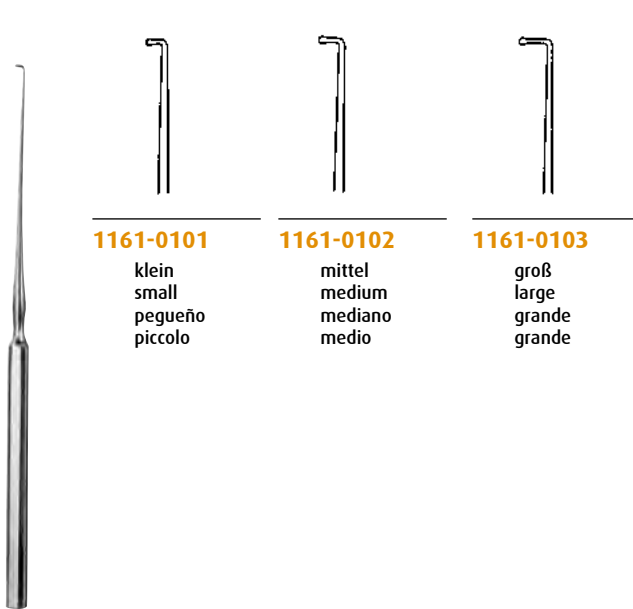

1161-0101

klein
small
pequeño
piccolo

1161-0102

mittel
medium
mediano
medio

1161-0103

groß
large
grande
grande

LUCAE

1161-0101 - 1161-0103 14,0 cm / 5 1/2"

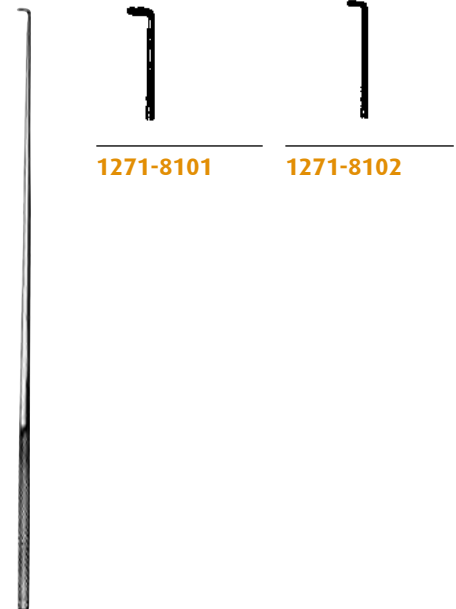

1271-8101

1271-8102

DAY

1271-8101 - 1271-8102 16,0 cm / 6 3/4"

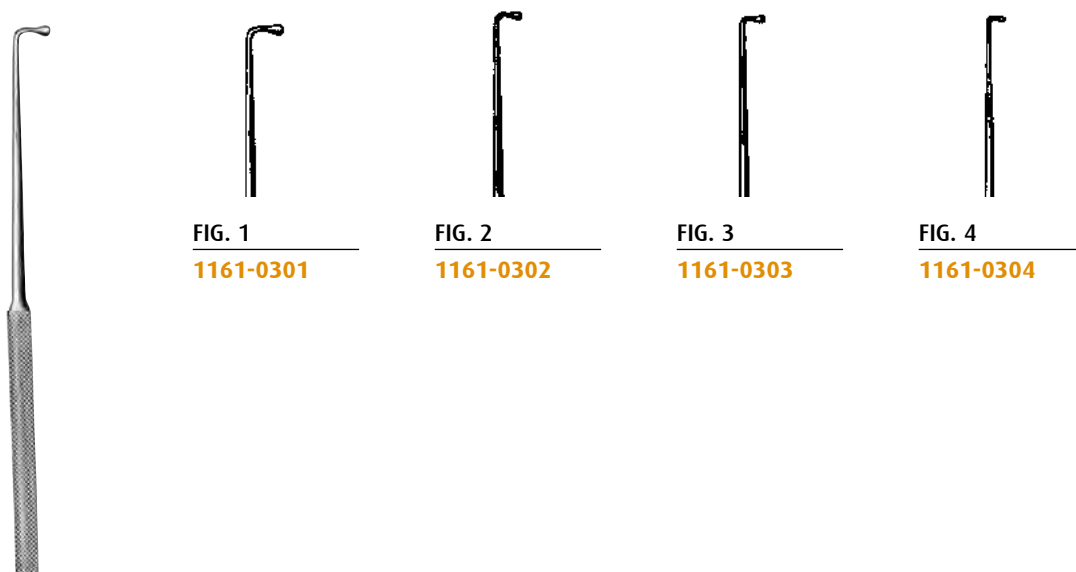

FIG. 1

1161-0301

FIG. 2

1161-0302

FIG. 3

1161-0303

FIG. 4

1161-0304

WAGNER

1161-0301 - 1161-0304 14,0 cm / 5 1/2"

Trommelfellnadeln
Tympanum Needles
Agujas para tímpano
Aghi per timpano



POLITZER

1273-0916 16,0 cm / 6 1/2"

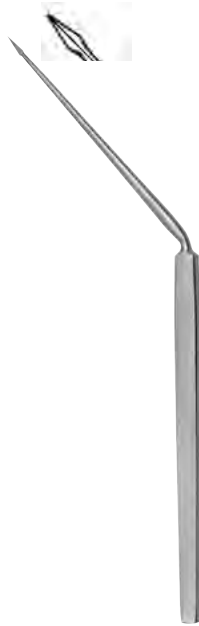

Nadel quergestellt
 needle horizontally
 aguja en posición horizontal
 ago orizzontale

POLITZER

1273-1116 16,0 cm / 6 1/4"



POLITZER

1273-1118 15,0 cm / 6"

Furunkelmesser
 Furuncle Knife
 cuchillo para furúnculos
 Coltello per foruncoli



POLITZER

1273-0816 18,0 cm / 7"



LUCAE

1273-1402 18,0 cm / 7"



LUCAE

1273-1403 18,0 cm / 7"



LEMPERT
1273-2018 20,5 cm / 8"



LEMPERT
1273-2020 18,0 cm / 7"



LEMPERT
1404-6900 - 1404-6904 20,0 cm / 8"

FIG. 0
1404-6900

FIG. 00
1404-6901

FIG. 1
1404-6902

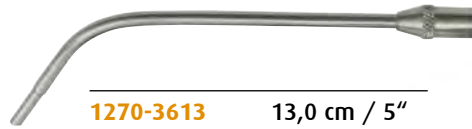

FIG. 2
1404-6903

FIG. 3
1404-6904



1270-3608 11,0 cm / 4"

Ohrkanüle
Ear cannula
Cánula auricular
Cannula auricolare



1270-3613 13,0 cm / 5"

Ohrkanüle
Ear cannula
Cánula auricular
Cannula auricolare



1270-3611 8,0 cm / 3 1/8"

Ohrkanüle
Ear cannula
Cánula auricular
Cannula auricolare

1270-3650

Ventilball
Valve Rubber Bulb
Pera de goma con valva
Pallone in gomma con valva

1270-3601 30 ccm

Ersatzflasche
Spare Bottle
Frasco suelto
Bottiglia di ricambio

KABIERSKE

1270-3600

komplett mit 3 Kanülen und Gummiball
complete with 3 cannulas and rubber bulb
completo con 3 cánulas y pera de goma
completo con 3 cannule e pera di gomma



UNIVERSAL

1270-3900

Komplett mit beweglicher Düse, Nasenolive, Schraubflasche und Gebläse
Complete with moveable tube, Nose Olive, screw bottle and rubber bulb
Completo con tubo mòvil, oliva nasal, botella con rosca y pera de goma
Completo con tubo mobile, oliva nasale, bottiglia con filettatura e pera di gomma



1270-3403

Einsteckkonus
Connecting Nozzle
Cono de conexión
Cono di connessione



Ø 4 mm

1270-3404

Ohrolive
Ear olive
Oliva auricular
Oliva auricolare



Ø 15 mm

1270-3415

Nasololive
Nose Olive
Oliva nasal
Oliva nasale



Ø 17 mm

1270-3417

Nasololive
Nose Olive
Oliva nasal
Oliva nasale



Ø 22 mm

1270-3422

Nasololive
Nose Olive
Oliva nasal
Oliva nasale

POLITZER

1270-3450

komplett mit 3 Nasenoliven Art.-Nr. 1270-3415 - 1270-3422
complete with 3 nasal olives ref. 1270-3415 - 1270-3422
completo con 3 olivas nasales ref. 1270-3415 - 1270-3422
completo con 3 olive nasali rif. 1270-3415 - 1270-3422



POLITZER

1270-3402

komplett mit 4 Nasenoliven Art.-Nr. 1270-3404 - 1270-3422 in Kunststoffbox
complete with 4 nasal olives ref. 1270-3404 - 1270-3422 in plastic box
completo con 4 olivas nasales ref. 1270-3404 - 1270-3422 en caja plástica
completo con 4 olive nasali rif. 1270-3404 - 1270-3422 in scatola di plastica



1270-4405 50 ml

komplett mit Teller und 2 Ansätzen
complete with protection disc and 2 tips
completo con disco protector y 2 puntas
completo con disco protettivo e 2 punte



1270-4407 75 ml

komplett mit Teller und 2 Ansätzen
complete with protection disc and 2 tips
completo con disco protector y 2 puntas
completo con disco protettivo e 2 punte



1270-4410 100 ml

komplett mit Teller und 2 Ansätzen
complete with protection disc and 2 tips
completo con disco protector y 2 puntas
completo con disco protettivo e 2 punte



1270-4415 150 ml

komplett mit Teller und 2 Ansätzen
complete with protection disc and 2 tips
completo con disco protector y 2 puntas
completo con disco protettivo e 2 punte



1270-4200 10 ml

selbstfüllend in Kunststofftasche
self filling in plastic pouch
auto-rellena en bolsa plástica
auto-riempente in borsa di plastica



1270-4203

Verbindungsschlauch komplett mit Ventilaufsatz
und Saugansatz
Flexible Tube complete with Valve attachment
and suction nozzle
Tubo de conexión completo con Válvula de
conexión y pieza de succión
Tubo di connessione, completo con valvola
diconnessione e aspiratore



1270-4202

Ventilaufsatz
Valve Attachment
Válvula de conexión
Valvola di connessione



1270-4204

Saugansatz
Suction Nozzle
Pieza de succión
Aspiratore



1270-4205

Schutzeller
Protecting Disc
Disco protector
Disco protettivo



1270-4206

Metallolive
Metal Olive
Oliva metálica
Oliva in metallo



1270-4207

Konischer Ansatz
Conical Tip
Punta cónica
Punta conica



1270-4208

Geknöpfte Ansatz
Button ended Tip
Punta de botón
Punta a bottone



1270-4209

Gewindeansatz
Threaded Tip
Punta de rosca
Punta filettata

035

**Rhinologie
Rhinology
Rinología
Rinologia**

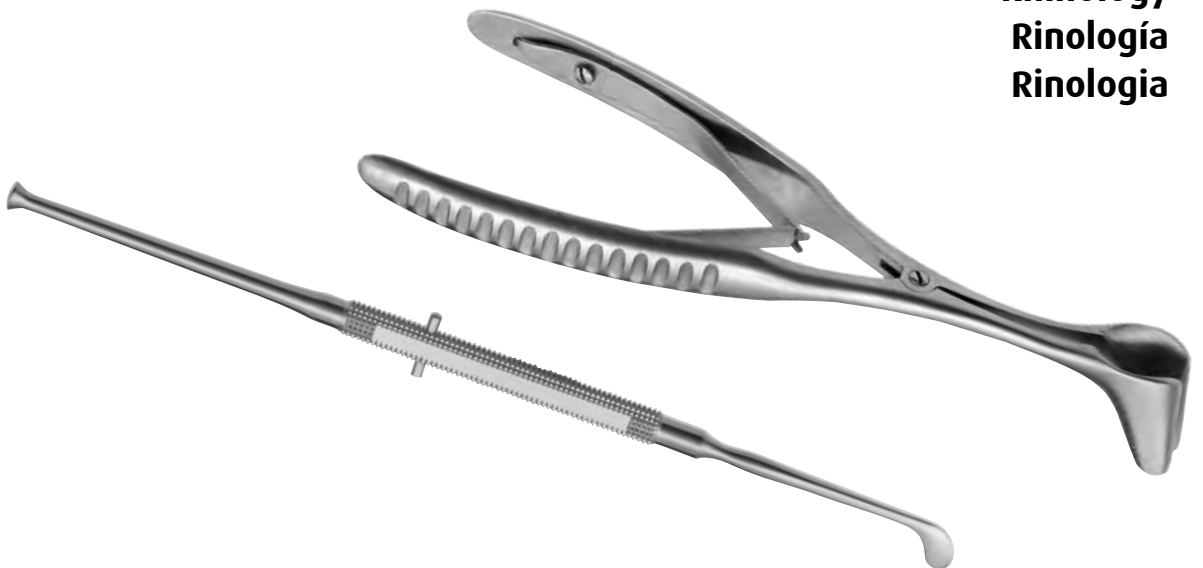



GOLDSMITH (THUDICHUM)

1265-0001 - 1265-0003 6,5 cm / 2 1/2"



Fig.1

1265-0001 21,0 x 9,5 mm



Fig.2

1265-0002 21,0 x 10,5 mm

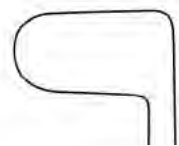

Fig.3

1265-0003 21,0 x 11,5 mm



HARTMANN-HALLE

1265-0901 - 1265-0903 15,0 cm / 6"

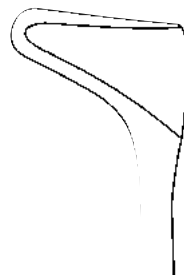

FIG. 1

1265-0901



FIG. 2

1265-0902



FIG. 3

1265-0903

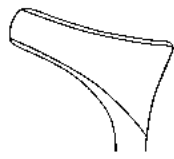

Fig.1
 1265-1301

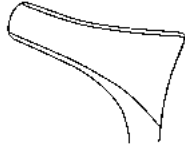

Fig.2
 1265-1302

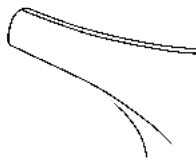

Fig.3
 1265-1303

HARTMANN

1265-1301 - 1265-1303

15,0 cm / 6"



Fig.1
 1265-1501



Fig.2
 1265-1502

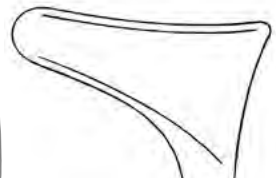
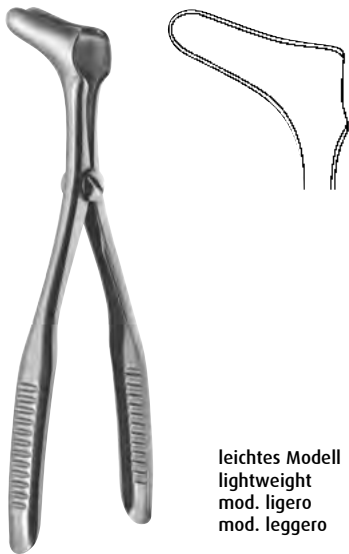

Fig.3
 1265-1503

MOD. WIEN

1265-1501 - 1265-1503

14,5 cm / 5 1/4"



leichtes Modell
 lightweight
 mod. ligero
 mod. leggero

MOD. WIEN

1265-1504 13,5 cm / 5 1/4"



Fig.1
 1265-0701



Fig.2
 1265-0702

TIECK-HALLE

1265-0701 - 1265-0702

13,0 cm / 5 1/8"

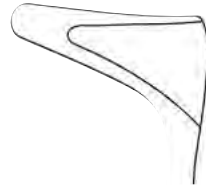

FIG. 1
1265-2501 35 mm

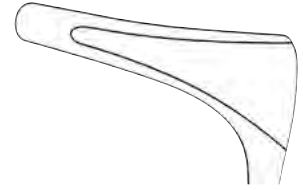

FIG. 2
1265-2502 50 mm

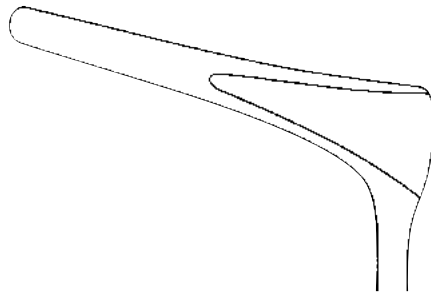

FIG. 3
1265-2503 75 mm

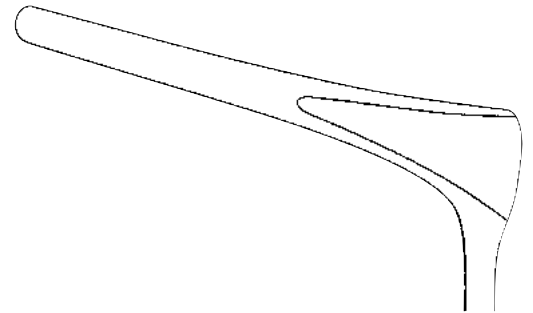

FIG. 4
1265-2504 90 mm

KILIAN

1265-2501 - 1265-2504 13,0 cm / 5 1/8"

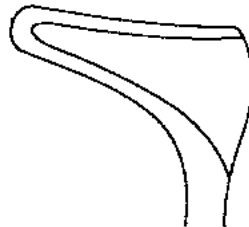

FIG. 1
1265-2801 35 mm

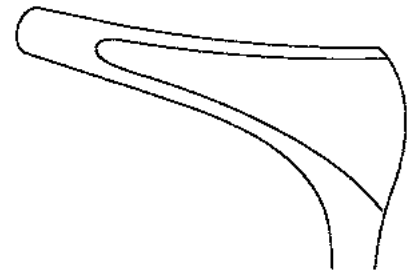

FIG. 2
1265-2802 50 mm

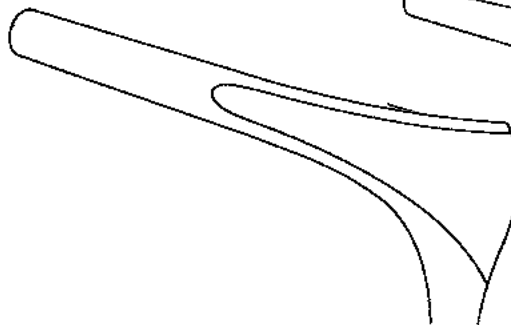

FIG. 3
1265-2803 75 mm

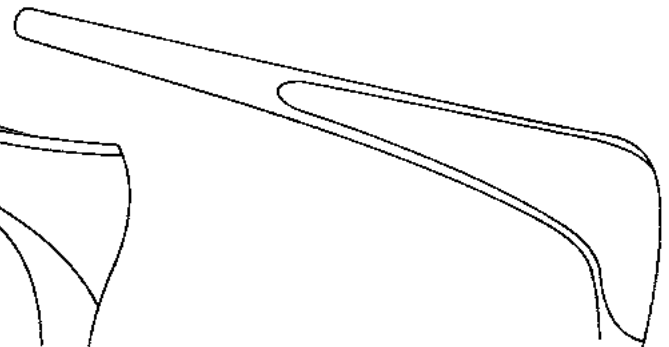

FIG. 4
1265-2804 90 mm

COTTLE

1265-2801 - 1265-2804 13,5 cm / 5 1/4"

Nasenspekula, Polypenschnürer
Nasal Specula, Polypus Snares
Espèculos nasales, Polipótomos
Specoli nasali, Serranodi per polipi



BECKMANN Fig.1
1265-1914 13,0 cm / 5¹/₈"



BECKMANN Fig.2
1265-1915 14,0 cm / 5"

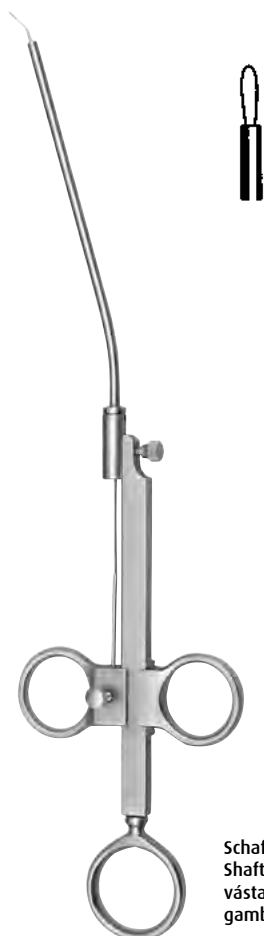

Schaft Ø 3 mm
 Shaft Ø 3 mm
 västago Ø 3mm
 gambo Ø 3 mm

KRAUSE
1266-2126 26,0 cm / 10¹/₄"



Schaft Ø 3 mm
 Shaft Ø 3 mm
 västago Ø 3mm
 gambo Ø 3 mm

KRAUSE-VOSS
1266-2326 26,0 cm / 10¹/₄"

mit 2 Ansätzen
 with 2 caps
 con 2 appliques
 con 2 punta

Schnürschlingen Ø 0,30 mm
 Bündel mit 12 Stück
 Snare loops Ø 0,30 mm
 Bundle with 12 pieces
 Asas de alambre Ø 0,30 mm
 Manajo de 12 piezas
 Lacci di filo di metallo Ø 0,30 mm
 Manello di 12 pezzi



1266-2730 10,0 cm

**TRÖLTSCH**

1134-0115 15,0 cm / 6"

**TRÖLTSCH**

1134-0118 18,0 cm / 7"

**JANSEN (GRÜNWALD)**1134-1718 18,0 cm / 7"
1134-1720 20,0 cm / 8"**WESTMACOTT**

1266-0420 20,0 cm / 8"

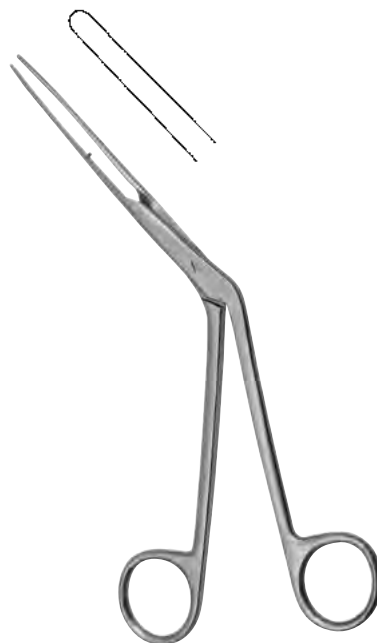
**LUBET-BARBON**1266-0320 18,5 cm / 7¹/₄"**HARTMANN**1266-0716 16,0 cm / 6¹/₄"

Nasenpolypenzangen, Septumzangen
Nasal Polypus Forceps, Septum Forceps
Pinzas para pólipos nasales, Pinzas para tabique nasal
Pinze per polipi nasali, Pinze per il setto nasale

035



HARTMANN
1266-0720 20,0 cm / 8"

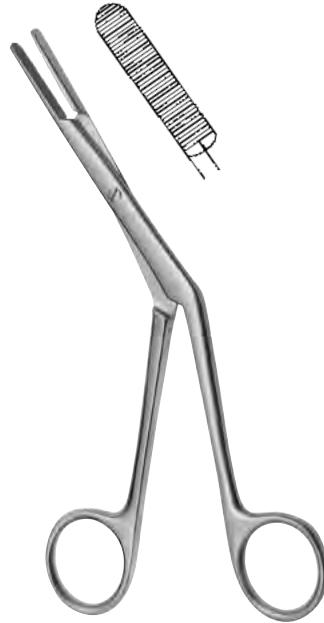

KILLIAN
1266-0917 17,0 cm / 6³/₄"



HEYMANN
1268-0402 18,0 cm / 7"

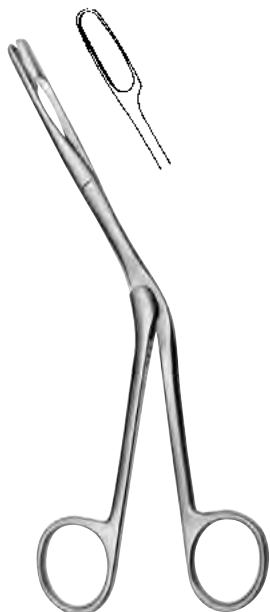

KNIGHT
1268-0619 18,0 cm / 7"

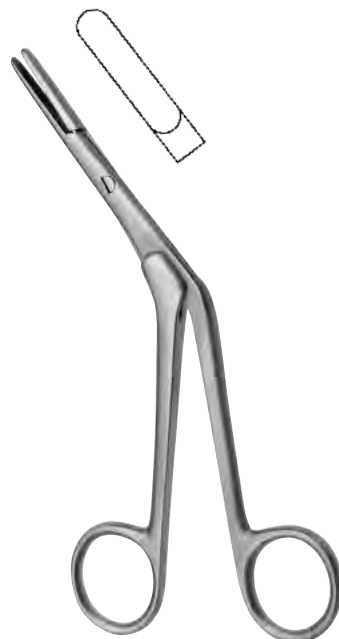

CRAIG
1268-0101 16,0 cm / 6¹/₄"



1268-0301
 links gebogen
 left curved
 curva por izquierda
 curva a sinistra



1268-0302
 rechts gebogen
 right curved
 curva por derecha
 curva a destra

1268-0301 - 1268-0302 16,0 cm / 6¹/₄"

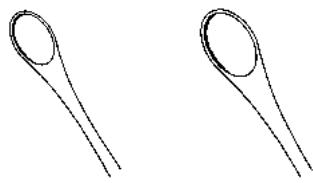

FIG. 1
1268-0701

FIG. 2
1268-0702

LUC
1268-0701 - 1268-0702 19,0 cm / 7 1/2"

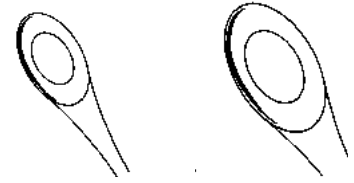
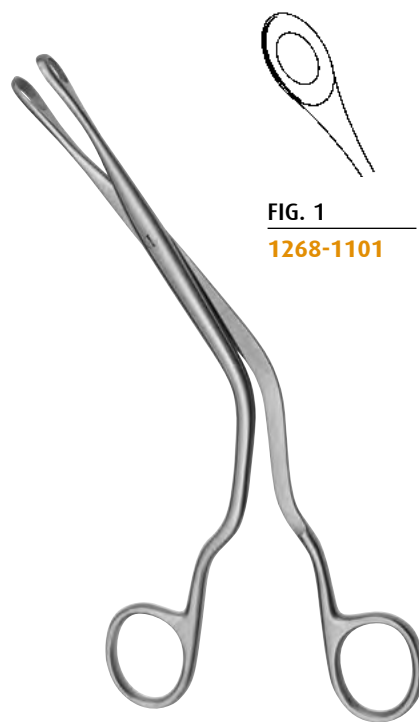

FIG. 1
1268-1101

FIG. 2
1268-1102

LUC
1268-1101 - 1268-1102 19,0 cm / 7 1/2"



FIG. 1
1268-1301



FIG. 2
1268-1302



FIG. 3
1268-1303



FIG. 4
1268-1304

BRUENINGS
1268-1301 - 1268-1304 19,0 cm / 7 1/2"

Siebbeinzangen, scharfe Nasenzangen
Ethmoid Bone Forceps, Nasal Cutting Forceps
Pinzas para etmoides, Pinzas nasales cortantes
Pinze etmoidali, Pinze taglienti per il naso

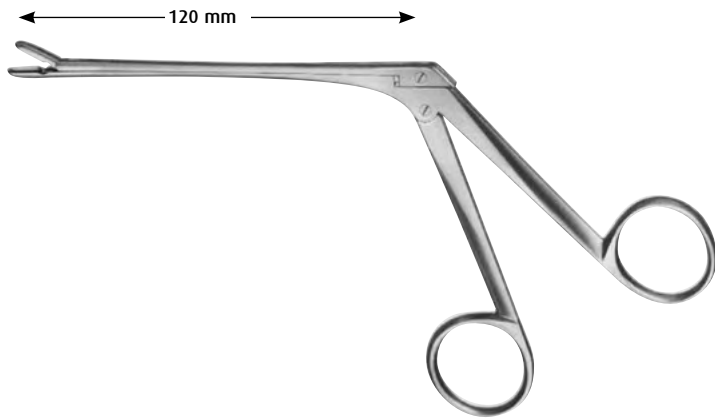

3 x 8 mm



1400-4403

gerade
straight
recto
retto

3 x 8 mm



1400-4503

aufgebogen
bent upwards
curva por arriba
curva in alto

TAKAHASHI

1400-4403 - 1400-4503

19,0 cm / 7 1/2"

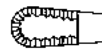
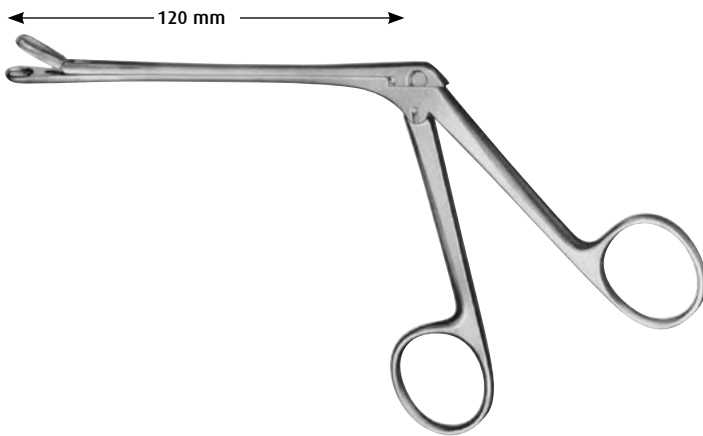

WATSON-WILLIAMS

1400-4203

gerade
straight
recto
retto



1400-4201

gerade
straight
recto
retto

1400-4203 - 1400-4201

19,0 cm / 7 1/2"

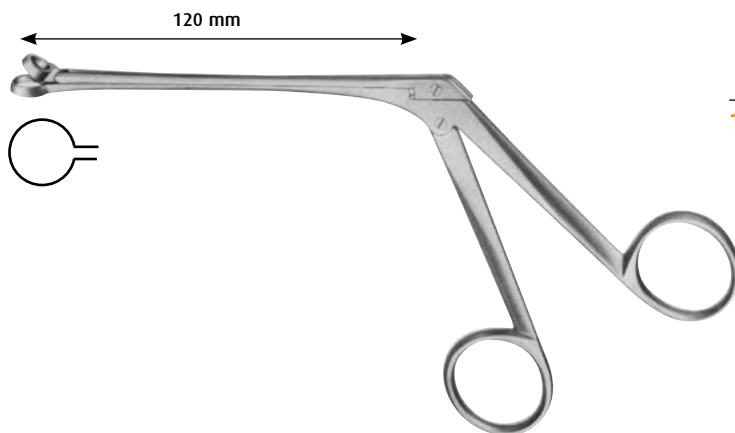

1400-4005 Ø 5 mm



1400-4007 Ø 7 mm



1400-4009 Ø 9 mm



1400-4011 Ø 11 mm

HARTMANN

1400-4005 - 1400-4011

19,0 cm / 7 1/2"

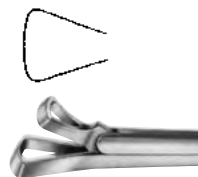

Maulbreite 8,0 mm
jaw width 8,0 mm
anchura de la boca 8,0 mm
larghezza della bocca 8,0 mm

SCHMEDEN

1400-4112 19,0 cm / 7 1/2"

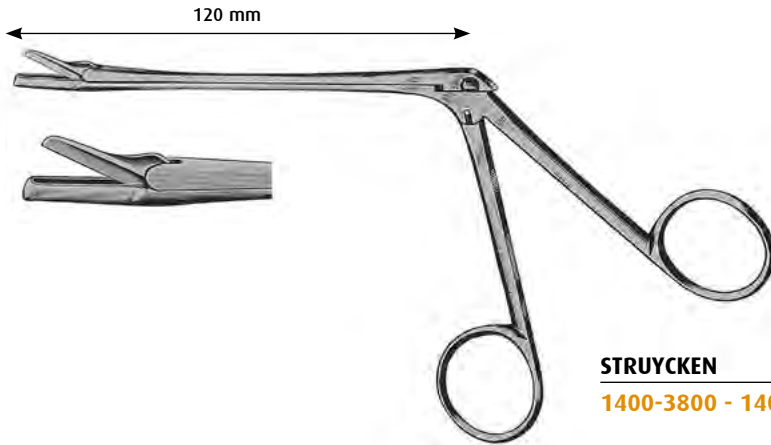

STRUYCKEN

1400-3800 - 1400-3801

19,0 cm / 7 1/2"

FIG. 1

1400-3800

Maulbreite 1,0 mm
 jaw width 1,0 mm
 anchura de la boca 1,0 mm
 larghezza della bocca 1,0 mm

FIG. 2

1400-3801

Maulbreite 1,5 mm
 jaw width 1,5 mm
 anchura de la boca 1,5 mm
 larghezza della bocca 1,5 mm

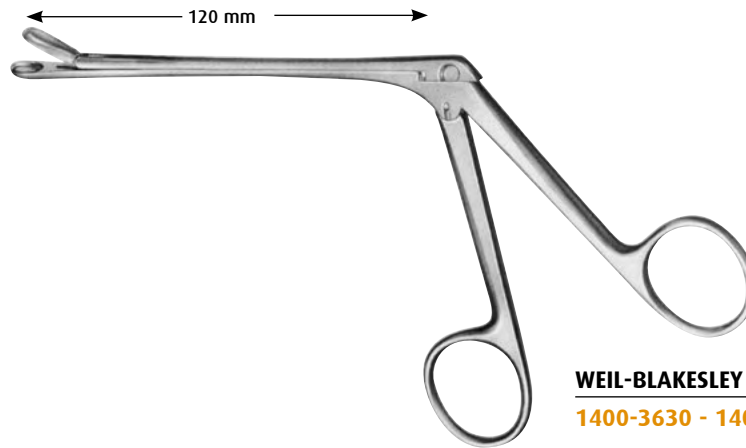

WEIL-BLAKESLEY

1400-3630 - 1400-3663

19,0 cm / 7 1/2"



FIG. 1

1400-3630

Maulbreite 3,0 mm
 jaw width 3,0 mm
 anchura de la boca 3,0 mm
 larghezza della bocca 3,0 mm



FIG. 2

1400-3636

Maulbreite 3,5 mm
 jaw width 3,5 mm
 anchura de la boca 3,5 mm
 larghezza della bocca 3,5 mm

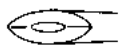

FIG. 3

1400-3642

Maulbreite 4,5 mm
 jaw width 4,5 mm
 anchura de la boca 4,5 mm
 larghezza della bocca 4,5 mm



FIG. 4

1400-3648

Maulbreite 5,0 mm
 jaw width 5,0 mm
 anchura de la boca 5,0 mm
 larghezza della bocca 5,0 mm



FIG. 5

1400-3658

Maulbreite 5,5 mm
 jaw width 5,5 mm
 anchura de la boca 5,5 mm
 larghezza della bocca 5,5 mm



mit Hals
 with neck
 con cuello
 con collo

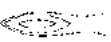

FIG. 1

1400-3659

Maulbreite 3,0 mm
 jaw width 3,0 mm
 anchura de la boca 3,0 mm
 larghezza della bocca 3,0 mm



FIG. 2

1400-3660

Maulbreite 3,5 mm
 jaw width 3,5 mm
 anchura de la boca 3,5 mm
 larghezza della bocca 3,5 mm

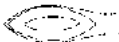

FIG. 3

1400-3661

Maulbreite 4,5 mm
 jaw width 4,5 mm
 anchura de la boca 4,5 mm
 larghezza della bocca 4,5 mm



FIG. 4

1400-3662

Maulbreite 5,0 mm
 jaw width 5,0 mm
 anchura de la boca 5,0 mm
 larghezza della bocca 5,0 mm

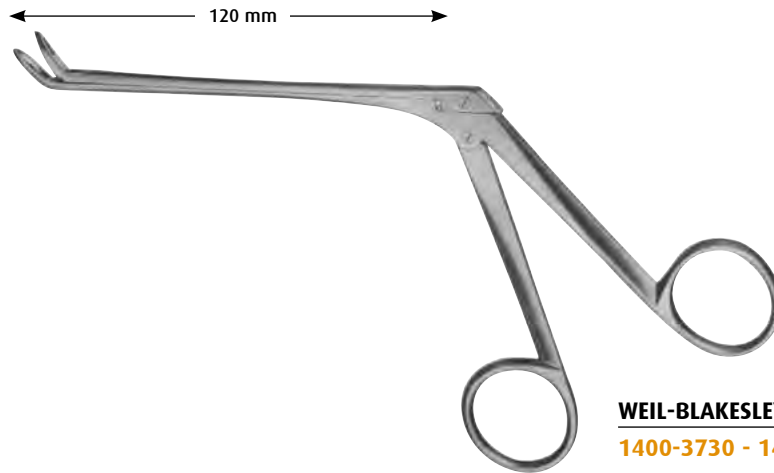

FIG. 5

1400-3663

Maulbreite 5,5 mm
 jaw width 5,5 mm
 anchura de la boca 5,5 mm
 larghezza della bocca 5,5 mm

Scharfe Nasenzangen
 Nasal Cutting Forceps
 Pinzas nasales cortantes
 Pinze taglienti per il naso



WEIL-BLAKESLEY

1400-3730 - 1400-3748

19,0 cm / 7 1/2"



45°



FIG. 1

1400-3730

Maulbreite 3,0 mm
 jaw width 3,0 mm
 anchura de la boca 3,0 mm
 larghezza della bocca 3,0 mm

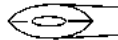

FIG. 2

1400-3736

Maulbreite 3,5 mm
 jaw width 3,5 mm
 anchura de la boca 3,5 mm
 larghezza della bocca 3,5 mm



FIG. 3

1400-3742

Maulbreite 4,5 mm
 jaw width 4,5 mm
 anchura de la boca 4,5 mm
 larghezza della bocca 4,5 mm

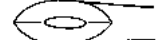
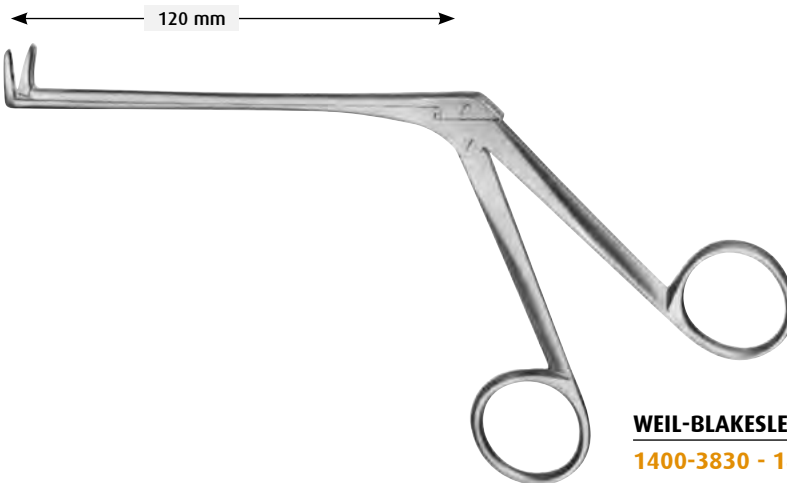

FIG. 4

1400-3748

Maulbreite 5,0 mm
 jaw width 5,0 mm
 anchura de la boca 5,0 mm
 larghezza della bocca 5,0 mm



WEIL-BLAKESLEY

1400-3830 - 1400-3848

19,0 cm / 7 1/2"

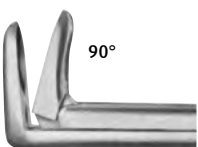

90°



FIG. 1

1400-3830

Maulbreite 3,0 mm
 jaw width 3,0 mm
 anchura de la boca 3,0 mm
 larghezza della bocca 3,0 mm



FIG. 2

1400-3836

Maulbreite 3,5 mm
 jaw width 3,5 mm
 anchura de la boca 3,5 mm
 larghezza della bocca 3,5 mm



FIG. 3

1400-3842

Maulbreite 4,5 mm
 jaw width 4,5 mm
 anchura de la boca 4,5 mm
 larghezza della bocca 4,5 mm

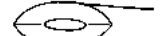
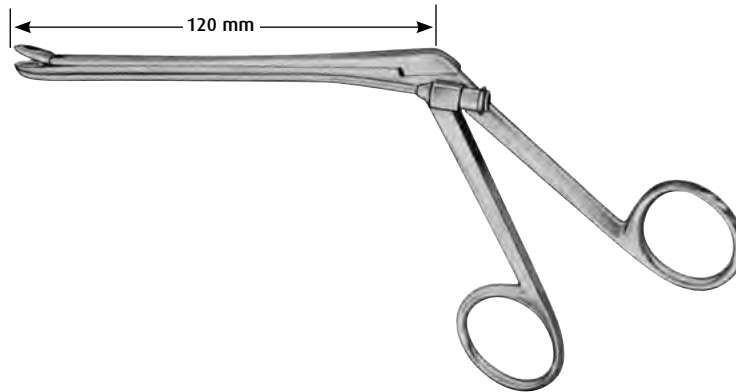

FIG. 4

1400-3848

Maulbreite 5,0 mm
 jaw width 5,0 mm
 anchura de la boca 5,0 mm
 larghezza della bocca 5,0 mm



WEIL-BLAKESLEY

1400-3630 A - 1400-4048 A 19,0 cm / 7 1/2"

gerade
straight
recta
retta



1400-3630 A 2,5 mm

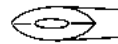

1400-3636 A 3,6 mm



1400-3648 A 4,8 mm

45° aufgebogen
45° up curved
45° curva arriba
45° curva in alto



1400-3730 A 2,5 mm



1400-3736 A 3,6 mm



1400-3748 A 4,8 mm

90° aufgebogen
90° up curved
90° curva arriba
90° curva in alto



1400-3830 A 2,5 mm

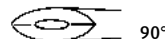

1400-3836 A 3,6 mm



1400-3848 A 4,8 mm

rechts gebogen
right curved
curva por derecha
curva a destra



1400-3930 A 2,5 mm

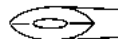

1400-3936 A 3,6 mm

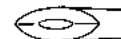

1400-3948 A 4,8 mm

links gebogen
left curved
curva por izquierda
curva a sinistra



1400-4030 A 2,5 mm



1400-4036 A 3,6 mm

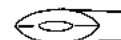

1400-4048 A 4,8 mm

Scharfe Nasenzangen, Antrumstanzen
Nasal Cutting Forceps, Antrum Punches
Pinzas nasales cortantes, Pinzas sacabocados para seno maxilar
Pinze taglienti per il naso, Pinze tagliente per seno mascellare

035

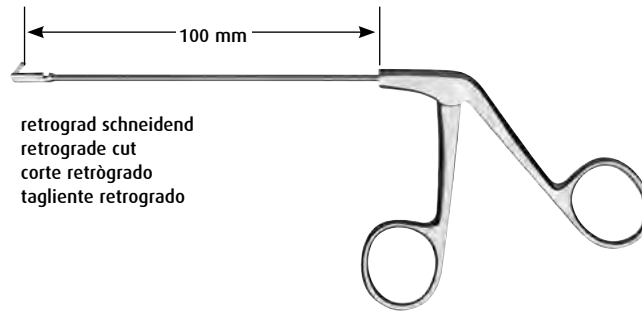

retrograd schneidend
 retrograde cut
 corte retrògrado
 tagliente retrogrado

STAMMBERGER

1267-9410 - 1267-9412

Antrumstanze
 Antrum Punch
 Pinza saca-bocado para seno maxilar
 Pinza tagliente per seno mascellare

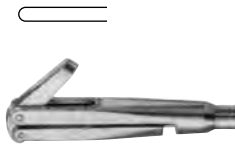

1267-9410 2 mm
 oben schneidend
 up cutting
 cortante por arriba
 tagliente in alto



1267-9411 2 mm
 rechts schneidend
 righth cutting
 cortante a la derecha
 tagliente a destra



1267-9412 2 mm
 links schneidend
 left cutting
 cortante a la izquierda
 tagliente a sinistra

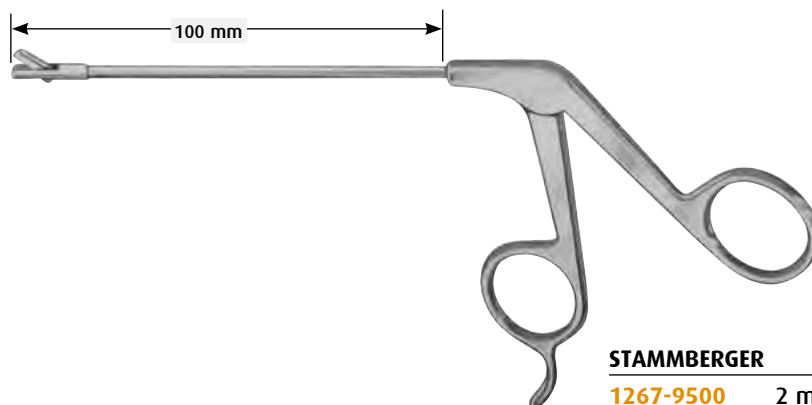

STAMMBERGER

1267-9500 2 mm

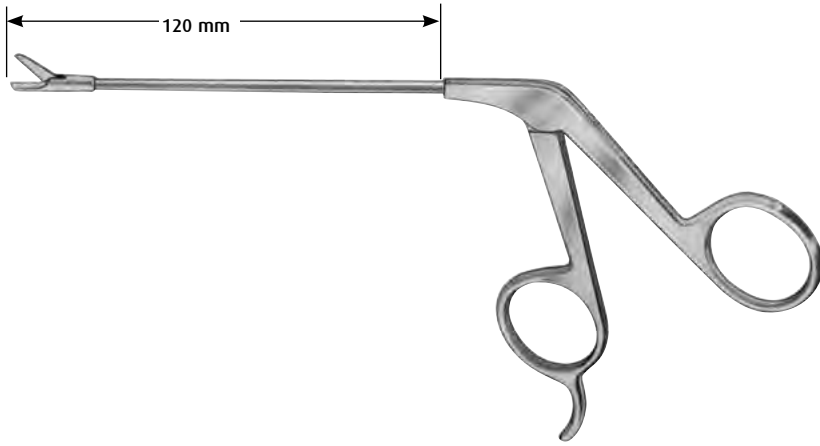

1276-0000 - 1276-0002



1276-0000 Ø 5 mm

gerade schneidend
straight cutting
cortante recto
tagliente retto

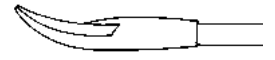

1276-0001 Ø 5 mm

rechts gebogen schneidend
right curved cutting
cortante curva derecha
tagliente curva destra

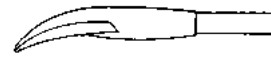

1276-0002 Ø 5 mm

links gebogen schneidend
left curved cutting
cortante curva izquierda
tagliente curva sinistra

MICRO

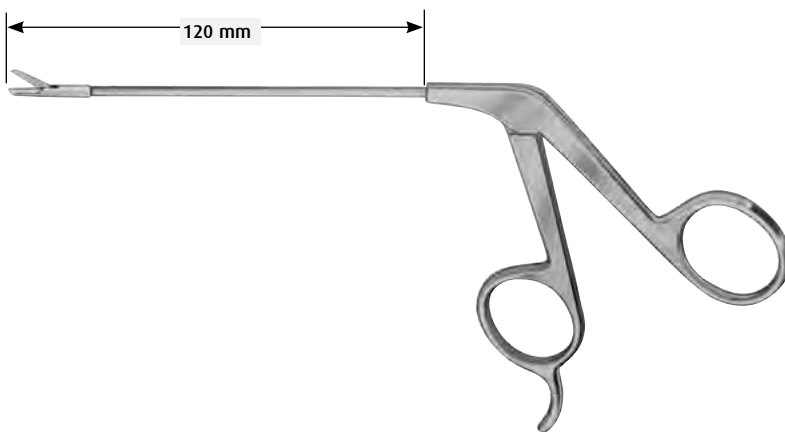

1276-1001 - 1276-1003



1276-1001 Ø 3,5 mm

gerade schneidend
straight cutting
cortante recto
tagliente retto



1276-1002 Ø 3,5 mm

rechts gebogen schneidend
right curved cutting
cortante curva derecha
tagliente curva destra

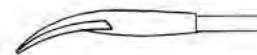

1276-1003 Ø 3,5 mm

links gebogen schneidend
left curved cutting
cortante curva izquierda
tagliente curva sinistra

Septumzangen
Septum Forceps
Pinzas para tabique nasal
Pinze per il setto nasale

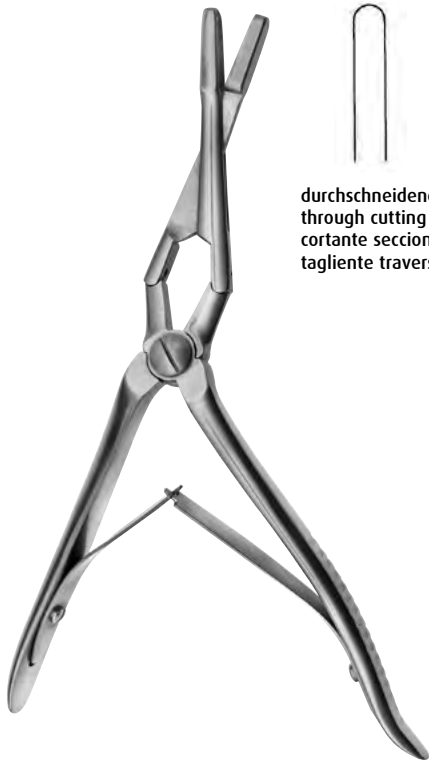

durchschneidend
 through cutting
 cortante seccional
 tagliante trasverso

MIDDLETON-JANSEN
1268-3002 19,0 cm / 7½"



MIDDLETON-JANSEN
1268-3001 19,0 cm / 7½"



eine Schneide gezahnt
 one toothed cutting edge
 una hoja dentada
 una lama dentata

CAPLAN
1268-4120 20,0 cm / 8"



RUBIN
1268-4421 21,0 cm / 8¼"



1268-4499
 Schutzkappe
 Protection Cap
 Caperuza protectora
 Calotta protettiva

140 mm



1400-0640

oben schneidend
up cutting
cortante por arriba
tagliente in alto



1400-0740

unten schneidend
down cutting
cortante por abajo
tagliente in basso

HAJEK

1400-0640 - 1400-0740

14,0 cm / 5 1/2"

140 mm



1400-0635

oben schneidend
up cutting
cortante por arriba
tagliente in alto



1400-0735

unten schneidend
down cutting
cortante por abajo
tagliente in basso

HAJEK-KOFLER

1400-0635 - 1400-0735

14,0 cm / 5 1/2"

Antrumstanzen, Keilbeinstanzen
Antrum Punches, Sphenoid Bone Punches
Pinzas sacabocadas para seno maxilar, Pinzas sacabocados para esfenoides
Pinze taglianti per seno mascellare, Pinze taglianti per seno sfenoidale



3x3 mm



1400-0403

oben schneidend
up cutting
cortante por arriba
tagliante in alto

4x4 mm



1400-0404

oben schneidend
up cutting
cortante por arriba
tagliante in alto

5x5 mm



1400-0405

oben schneidend
up cutting
cortante por arriba
tagliante in alto

6x6 mm



1400-0406

oben schneidend
up cutting
cortante por arriba
tagliante in alto

KERRISON

1400-0403 - 1400-0406

17,0 cm / 6³/₄"



1400-0015 1,5 mm



1400-0022 2,0 mm



1400-0030 3,0 mm

CITELLI

1400-0015 - 1400-0030

17,0 cm / 6³/₄"

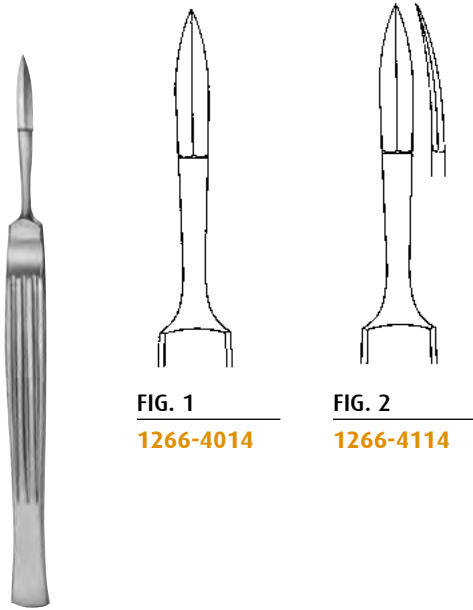

JOSEPH
 1266-4014 - 1266-4114 16,0 cm / 6 1/4"

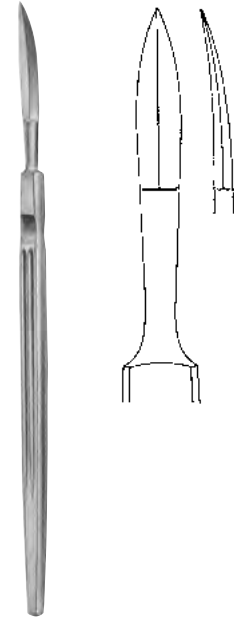

FOMON
 1266-4516 16,0 cm / 6 1/4"

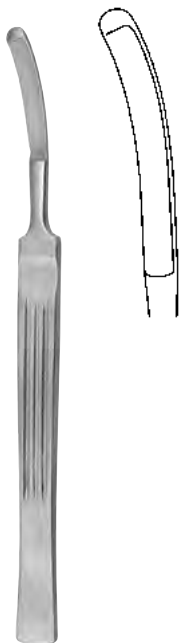

CONVERSE
 1266-4916 16,0 cm / 6 1/4"



JOSEPH
 1266-5015 15,0 cm / 6"



COTTLE
 1266-5215 15,0 cm / 6"

Septummesser
Septum Knives
Cuchillos para tabique nasal
Bisturi per il setto nasale

035



Mukosamesser
Mucosa Knife
cuchillo para mucosa
Bisturi per mucosa

FREER

1266-4615 16,5 cm / 6¹/₂"

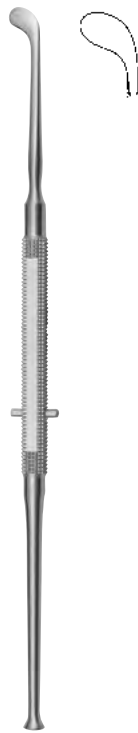

FREER

1266-6903 19,0 cm / 7¹/₂"

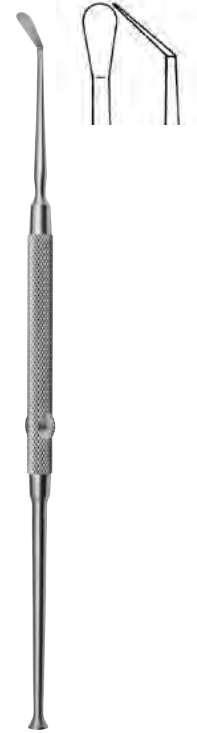

FREER

1266-6819 19,0 cm / 7¹/₂"

035

Septummesser, Schwingmesser
Septum Knives, Swivel Knives
Cuchillos para tabique nasal
Bisturi per il setto nasale



1267-1003 3,0 mm



1267-1004 4,0 mm



1267-1005 5,0 mm

BALLENGER

1267-1003 - 1267-1005 21,0 cm / 8¹/₄"

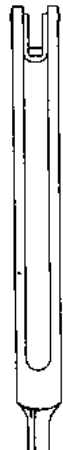

1267-1103 3,0 mm



1267-1104 4,0 mm

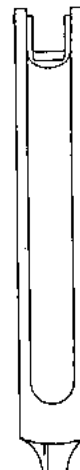

1267-1105 5,0 mm

BALLENGER

1267-1103 - 1267-1105 21,0 cm / 8¹/₄"

Septumelevatoren
Septum Elevators
Elevadores para tabique nasal
Elevatori per il setto nasale



Septummesser
 Septum Knife
 Cuchillo para tabique nasal
 Bisturi per il setto nasale

BRUENINGS

1266-4216 16,5 cm / 6 1/2"



1266-8304

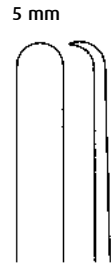

1266-8305

MC KENTY

1266-8304 - 1266-8305 15,0 cm / 6"

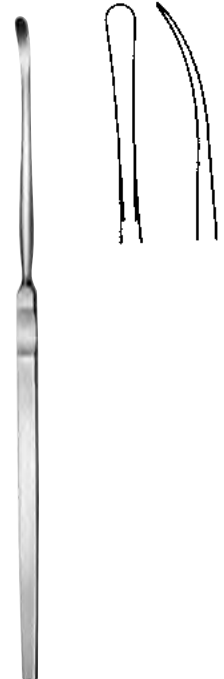

3,5 mm

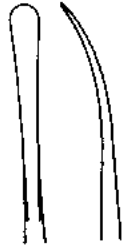

HALLE

1266-5518 16,0 cm / 6 1/4"



4 mm



JOSEPH

1403-5617 16,0 cm / 6 1/4"

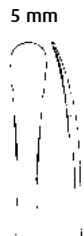

1403-5919

scharf
 sharp
 agudo
 acuto



1403-5819

stumpf
 blunt
 romo
 smusso

FREER

1403-5919 - 1403-5819 19,0 cm / 7 1/2"



5 mm

scharf / stumpf
 sharp / blunt
 agudo / romo
 acuto / smusso

FREER

1266-6318 18,0 cm / 7"

5 mm



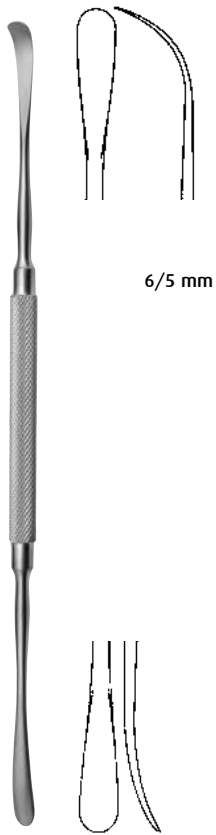

6/5 mm

FREER

1206-6520 20,5 cm / 8"



4 / 4 mm

MC KENTY

1266-7819 22,0 cm / 8³/₄"

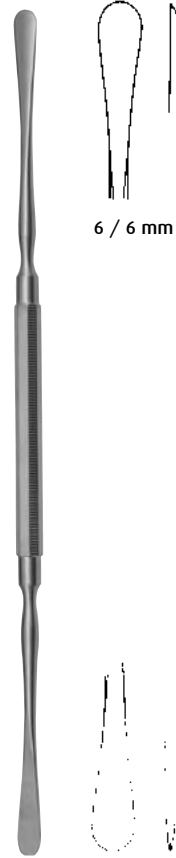

6 / 6 mm

BALLENGER-HAJEK

1266-7920 22,0 cm / 8³/₄"

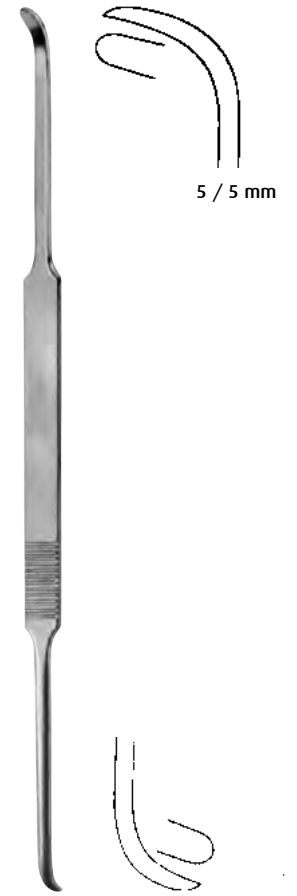

5 / 5 mm

COTTLE

1266-9322 23,5 cm / 9¹/₄"

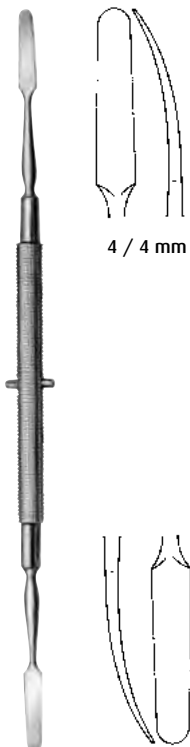

4 / 4 mm

KILIAN

1403-6318 18,0 cm / 7"

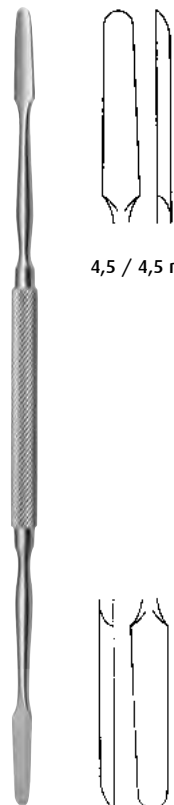

4,5 / 4,5 mm

KILIAN

1403-6322 22,0 cm / 8³/₄"

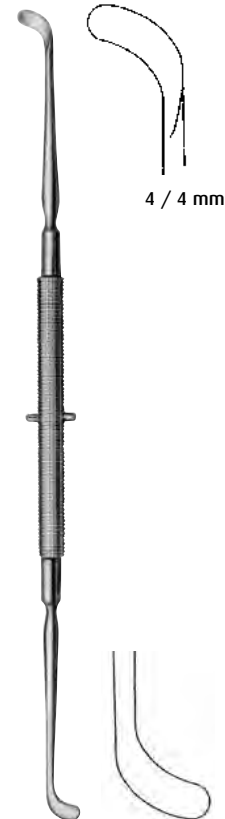

4 / 4 mm

PENNINGTON

1266-7321 21,5 cm / 7¹/₄"

Periostelevatorien
Periosteal Elevators
Legras para periostio
Elevatori per il perisoto

035



4 / 4 mm

ROGER

1266-7519 19,5 cm / 7³/₄"



4 mm

JOSEPH-MASING

1266-8822 21,5 cm / 8¹/₂"

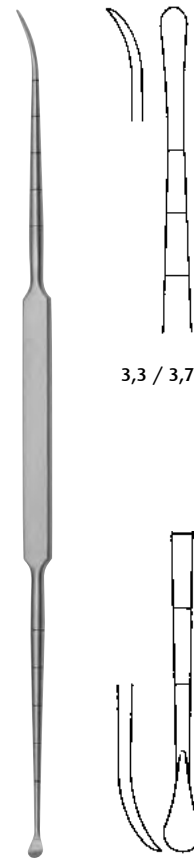

3,3 / 3,7 mm

COTTLE

1266-8121 22,0 cm / 8³/₄"

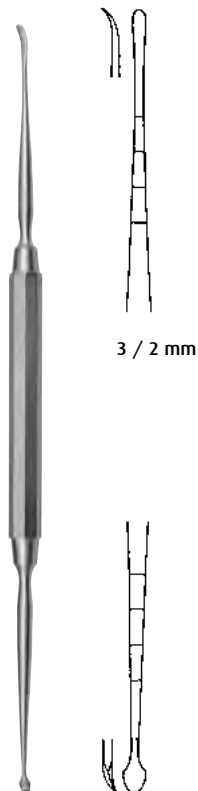

3 / 2 mm

MASING

1266-8122 21,0 cm / 8¹/₄"

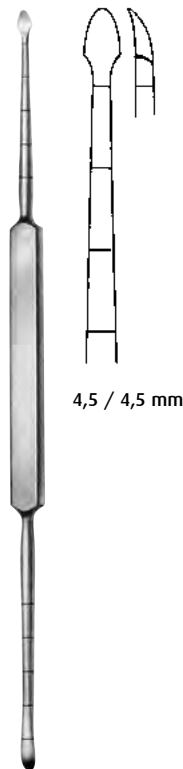

4,5 / 4,5 mm

COTTLE

1266-7921 21,0 cm / 8¹/₄"

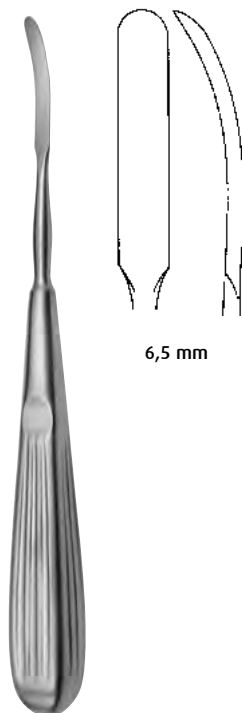

6,5 mm

JOSEPH

1266-8716 16,0 cm / 8¹/₄"

035

**Septummeißel
Septum Chisels
Cinceles para tabique nasal
Scalpello per il setto nasale**



FREER

1402-5503 16,0 cm / 6¹/₄"



FREER

1402-5504 16,0 cm / 6¹/₄"

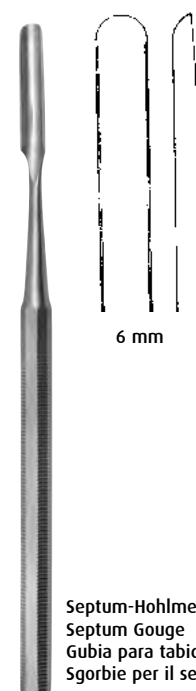

Septum-Hohlmeißel
Septum Gouge
Gubia para tabique nasal
Sgorbie per il setto nasale

FREER

1402-5606 15,0 cm / 6"

Septum-Hohlmeißel
 Septum Gouges
 Gubias para tabique nasal
 Sgorbie per il setto nasale

035



1267-0412 2 mm



1267-0414 4 mm



1267-0416 6 mm



1267-0418 8 mm

BALLENGER

1267-0412 - 1267-0418 15,0 cm / 6"

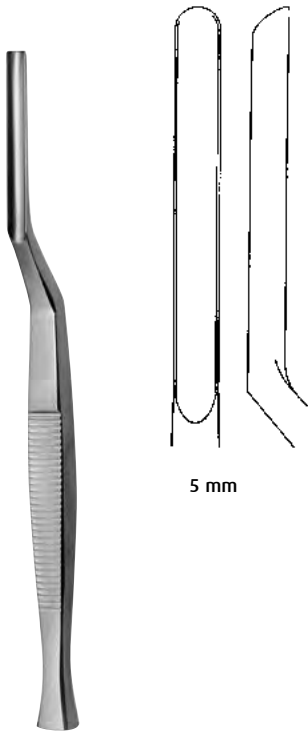

5 mm

KILLIAN

1267-0517 16,0 cm / 6 1/4"

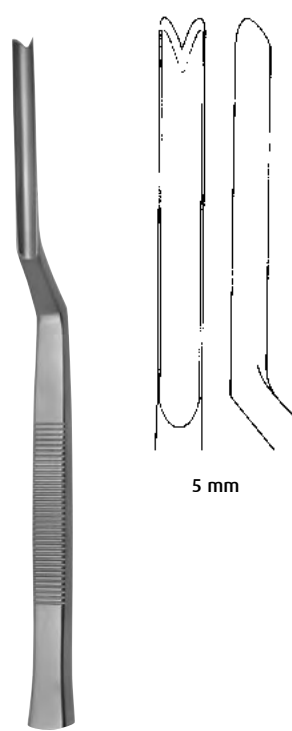

5 mm

KILLIAN

1267-0717 16,0 cm / 6 1/4"

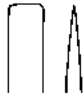

1267-2004 4 mm



1267-2007 7 mm



1267-2009 9 mm



1267-2012 12 mm

COTTLE

1267-2004 - 1267-2012 18,0 cm / 7"

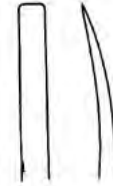

6 mm

COTTLE

1267-2106 18,0 cm / 7"



1267-2704 4 mm



1267-2707 7 mm



1267-2709 9 mm



1267-2712 12 mm

COTTLE

1267-2704 - 1267-2712 18,0 cm / 7"

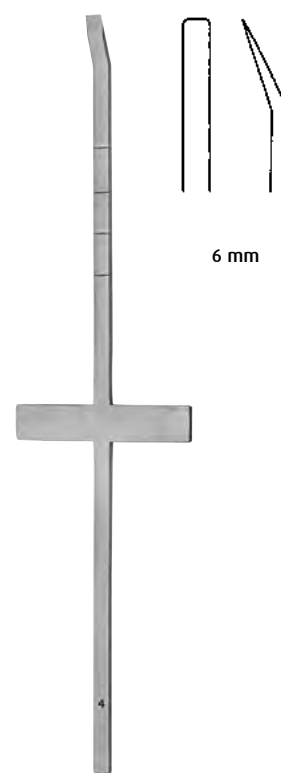

6 mm

COTTLE

1267-2806 18,0 cm / 7"

**Osteotome
Osteotomes
Osteótomos
Osteotomi**

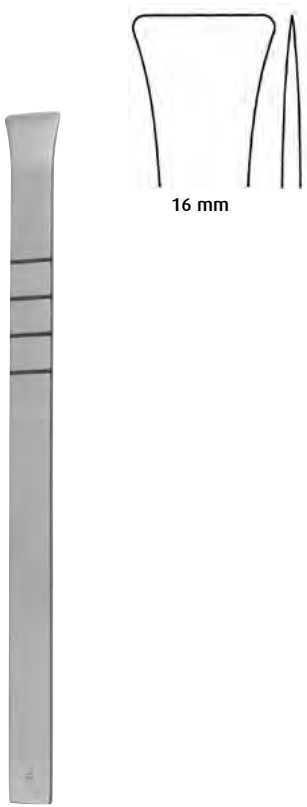

16 mm



16 mm

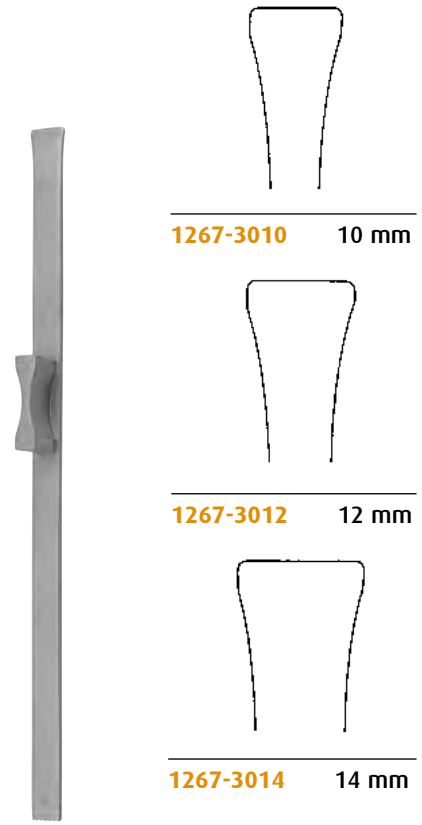

1267-3010 10 mm

1267-3012 12 mm

1267-3014 14 mm

COTTLE
1267-2614 18,0 cm / 7"

COTTLE
1267-2616 18,0 cm / 7"

RUBIN
1267-3010 - 1267-3014 18,0 cm / 7"

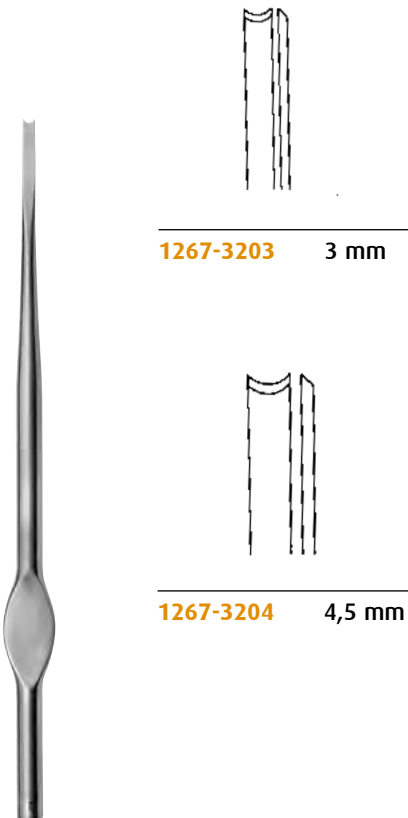

1267-3203 3 mm

1267-3204 4,5 mm

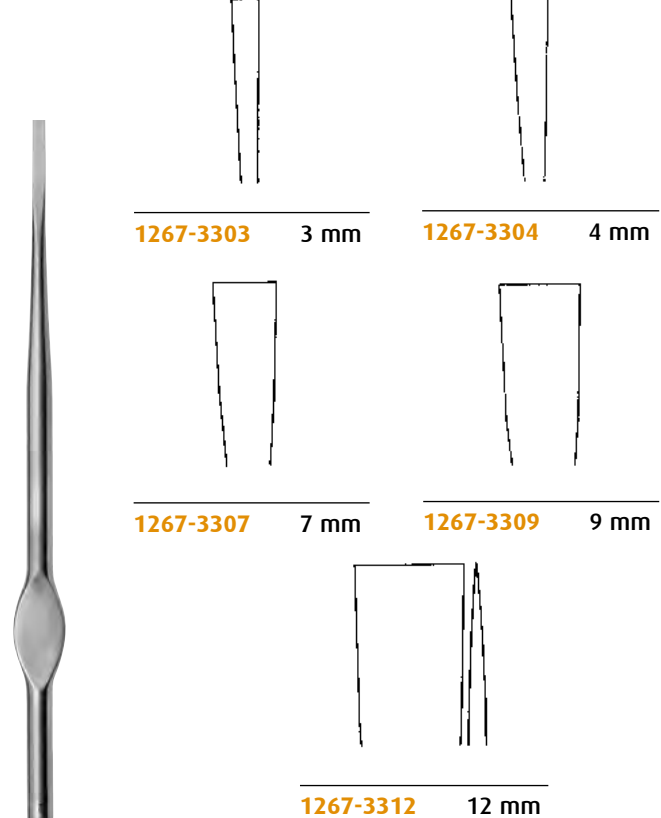

1267-3303 3 mm

1267-3304 4 mm

1267-3307 7 mm

1267-3309 9 mm

1267-3312 12 mm

WALTER
1267-3203 - 1267-3204 19,0 cm / 7 1/2"

WALTER
1267-3303 - 1267-3312 19,0 cm / 7 1/2"

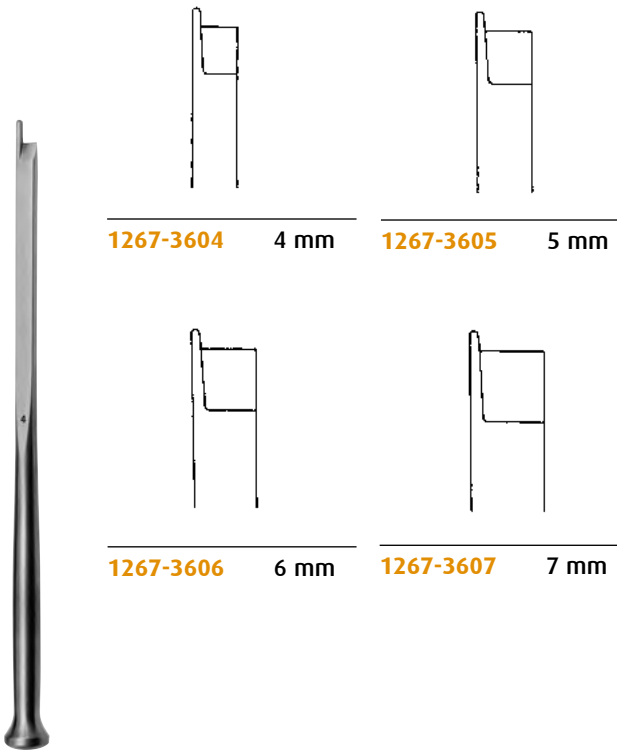

1267-3604 4 mm

1267-3605 5 mm

1267-3606 6 mm

1267-3607 7 mm

FOMON

1267-3604 - 1267-3607 16,0 cm / 6 1/4"

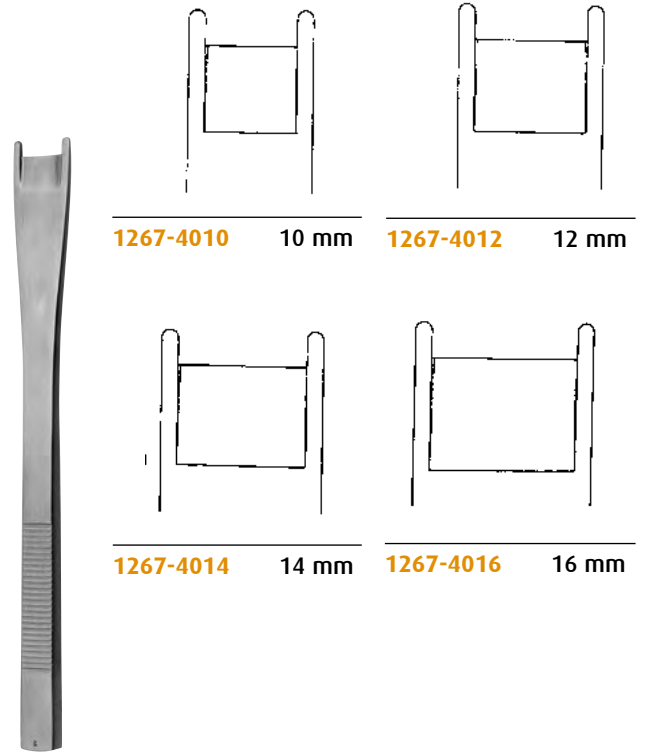

1267-4010 10 mm

1267-4012 12 mm

1267-4014 14 mm

1267-4016 16 mm

CINELLI

1267-4010 - 1267-4016 16,0 cm / 6 1/4"

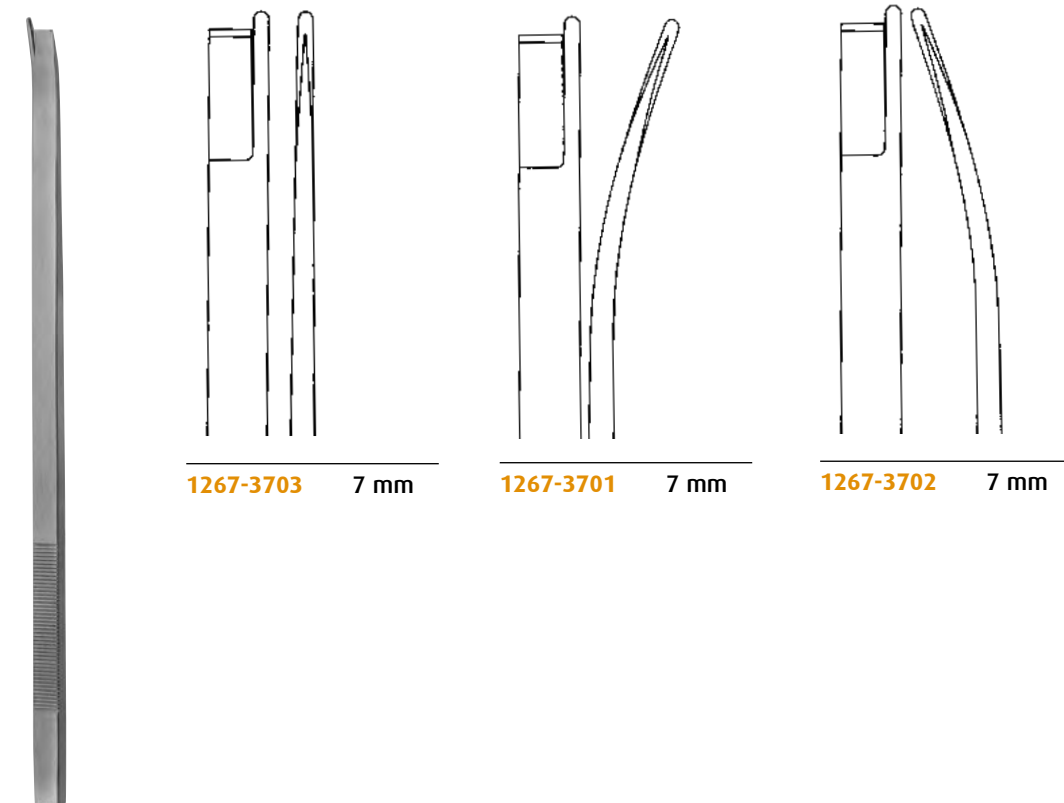

1267-3703 7 mm

1267-3701 7 mm

1267-3702 7 mm

NEIVERT-ANDERSON

1267-3703 - 1267-3702 20,5 cm / 8"



1267-3402 2 mm



1267-3403 3 mm



1267-3404 4 mm



1267-3405 5 mm



1267-3406 6 mm



1267-3407 7 mm



1267-3408 8 mm



1267-3410 10 mm



1267-3412 12 mm

SHEEHAN

1267-3402 - 1267-3412

15,0 cm / 6"



5 mm

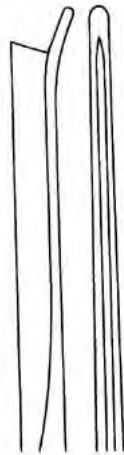

1267-4101

gerade
straight
recto
retto

5 mm

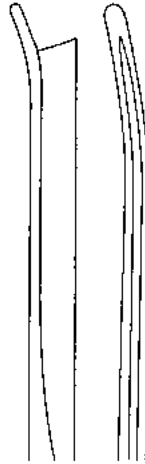

1267-4102

rechts
right
derecho
destra

5 mm

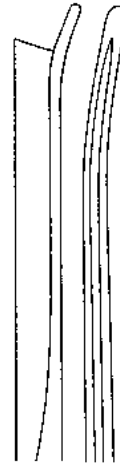

1267-4103

links
left
izquierdo
sinistra

SILVER

1267-4101 - 1267-4103

18,0 cm / 7"

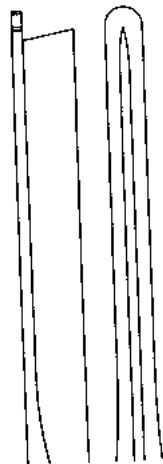

PARKES

1267-4201 16,0 cm / 6 1/4"



links abgewinkelt
angeled to left
angulado por izquierdo
anguato a sinistra

JOSEPH

1267-5101 17,0 cm / 6³/₄"



rechts abgewinkelt
angeled to right
angulado por derecho
anguato a destra

JOSEPH

1267-5102 17,0 cm / 6³/₄"



1267-5201

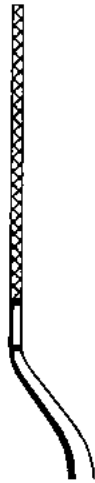

1267-5203



1267-5202

Arbeitslänge 40 mm
working length 40 mm
longitud de la punta 40 mm
lunghezza utile 40 mm

JOSEPH

1267-5201 - 1267-5202 19,0 cm / 7¹/₂"

Knorpelquetsche
Cartilage Crusher
Machacadora
Torchio per cartilagine

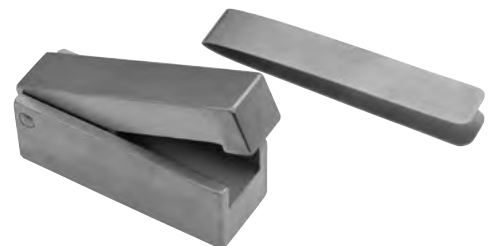

COTTLE

1267-5600

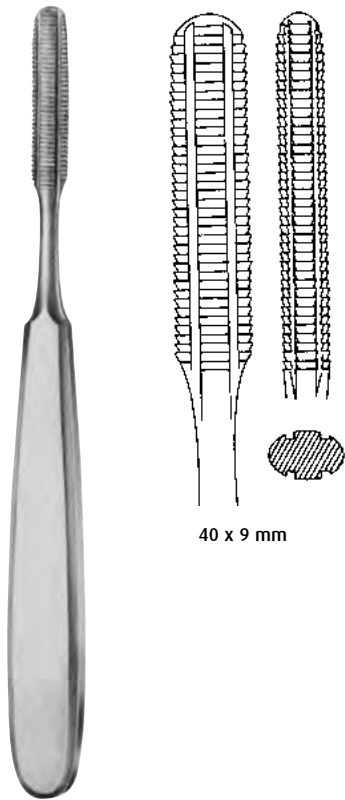

40 x 9 mm

MALTZ

1404-4218 17,5 cm / 7"

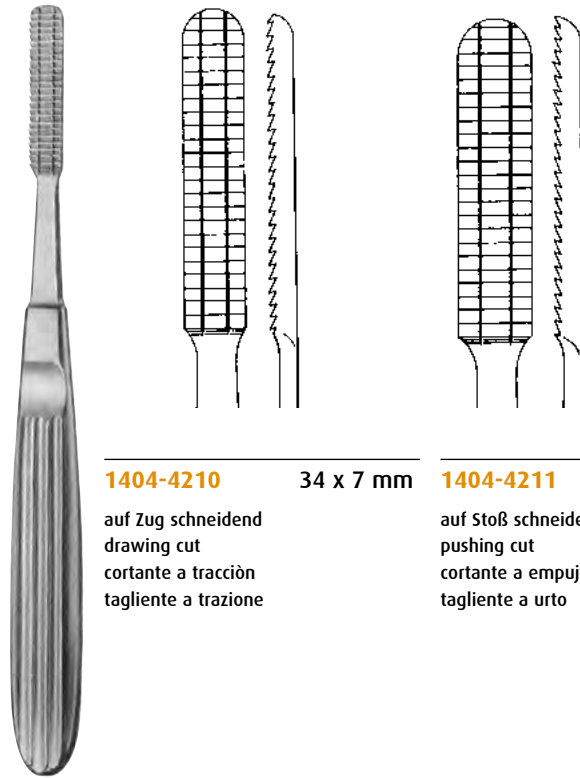

1404-4210

34 x 7 mm

auf Zug schneidend
 drawing cut
 cortante a tracciòn
 tagliente a trazione

1404-4211

34 x 7 mm

auf Stoß schneidend
 pushing cut
 cortante a empuje
 tagliente a urto

MALTZ

1404-4210 - 1404-4211 17,0 cm / 6³/₄"

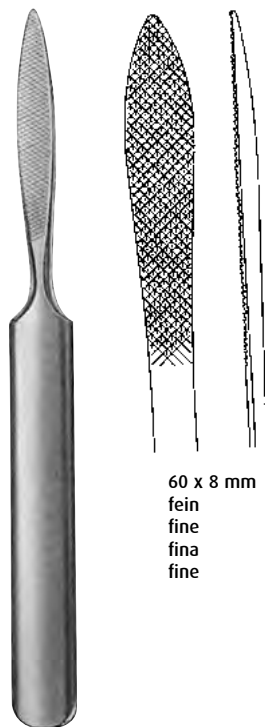

60 x 8 mm
 fein
 fine
 fina
 fine

JOSEPH

1404-4001 16,0 cm / 6¹/₄"

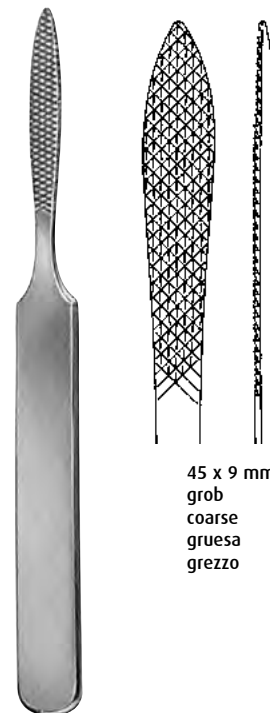

45 x 9 mm
 grob
 coarse
 gruesa
 grezzo

JOSEPH

1404-4002 16,0 cm / 6¹/₄"

Nasenraspeln, Knochenfeilen, Antrumraspeln

Nasal Rasps, Bone Files, Antrum Rasps

Escofinas nasales, Limas para huesos, Escofinas para el antro

Raspe nasali, Lime per ossa, Raspe per seno mascellare

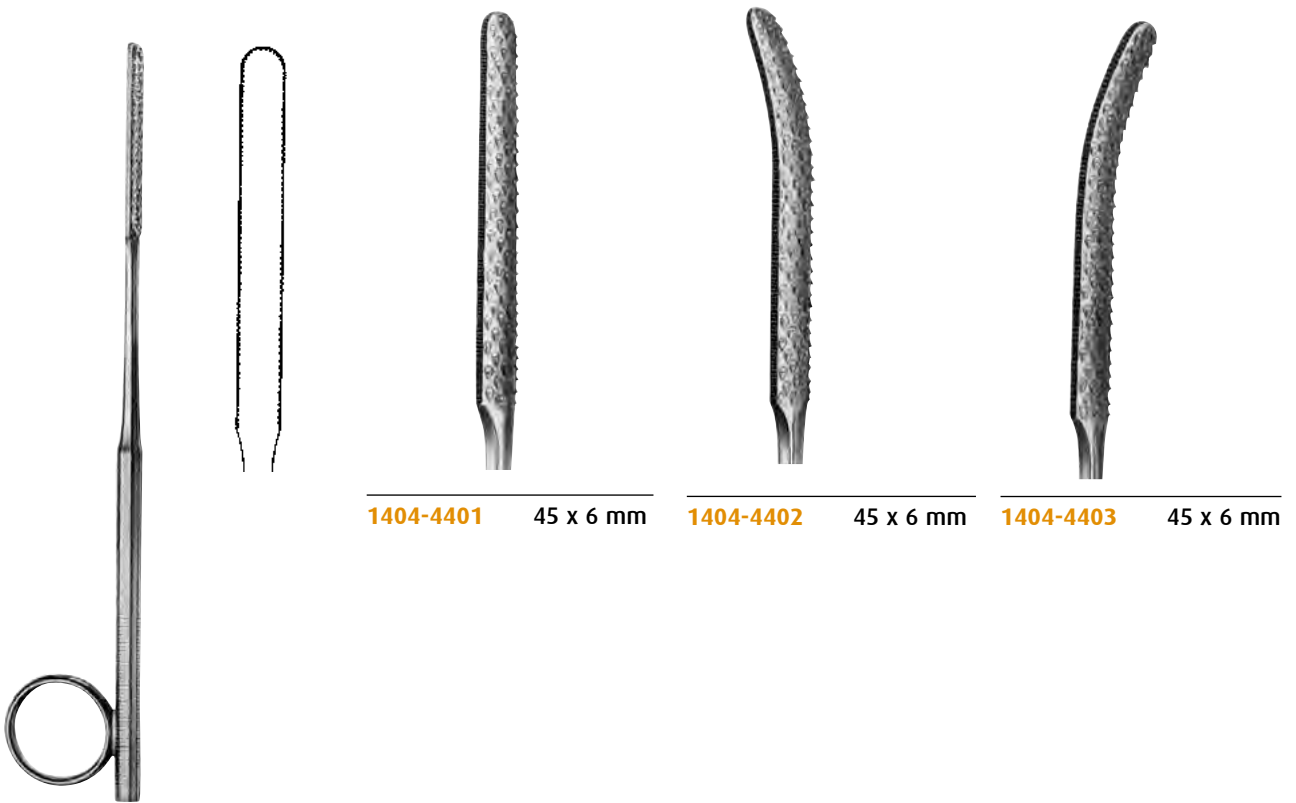

1404-4401 45 x 6 mm

1404-4402 45 x 6 mm

1404-4403 45 x 6 mm

GALLAHER

1404-4401 - 1404-4403

17,0 cm / 6³/₄"

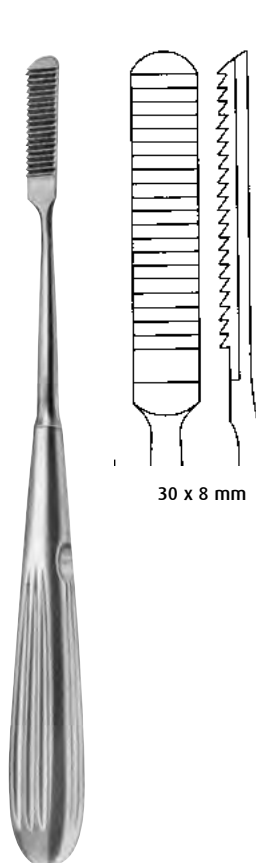

30 x 8 mm

COTTLE

1404-4221 21,0 cm / 8¹/₄"

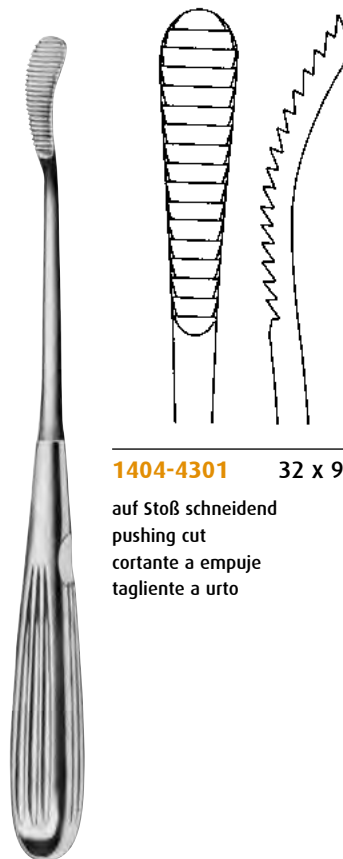

1404-4301 32 x 9 mm

auf Stoß schneidend
pushing cut
cortante a empuje
tagliante a urto

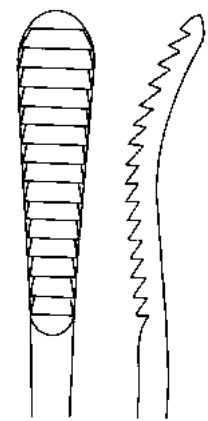

1404-4302 32 x 9 mm

auf Zug schneidend
drawing cut
cortante a traccion
tagliante a trazione

AUFRIEHT

1404-4301 - 1404-4302

21,0 cm / 8¹/₄"

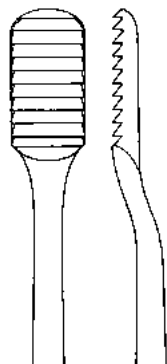

1404-4101
 auf Zug schneidend
 drawing cut
 cortante a traccion
 tagliente a trazione

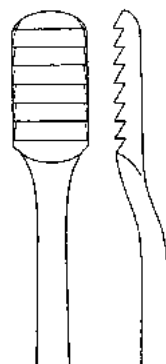

1404-4102
 auf Zug schneidend
 drawing cut
 cortante a traccion
 tagliente a trazione

LEWIS

1404-4101 - 1404-4102

19,0 cm / 7 1/2"



fein / grob
 fine / coarse
 fina / gruesa
 fino / grezzo

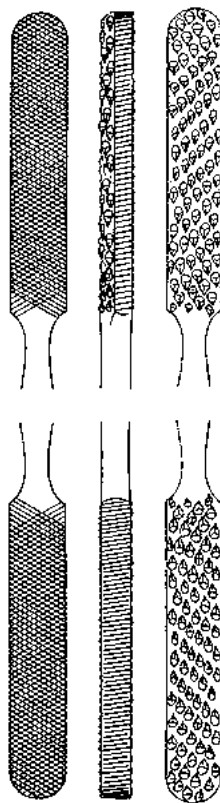

30 x 8 mm

FOMON

1404-4521 21,0 cm / 8 1/4"

TC

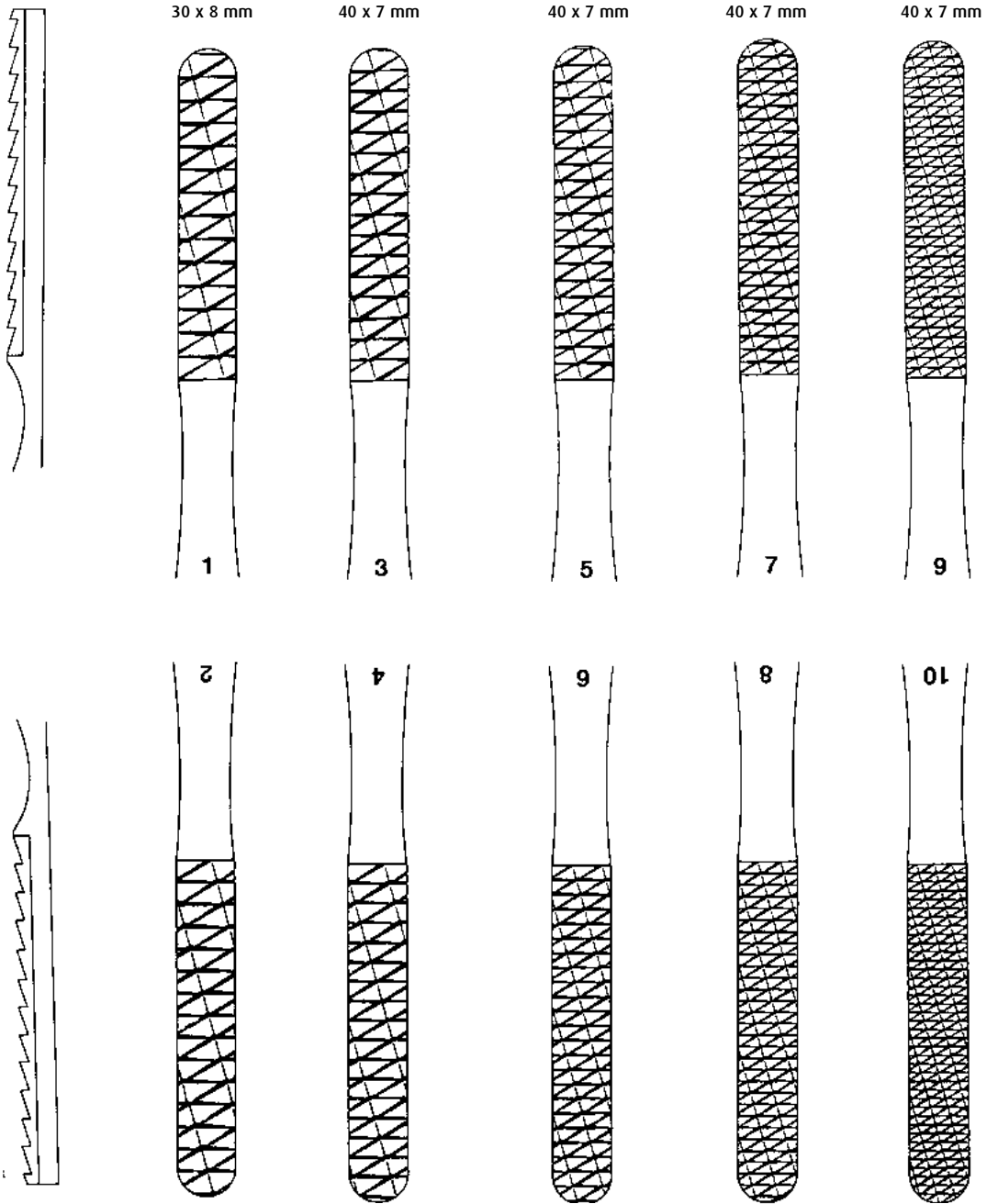

Fig. 1/2
 1404-4601

Fig. 3/4
 1404-4602

Fig. 5/6
 1404-4603

Fig. 7/8
 1404-4604

Fig. 9/10
 1404-4605

FOMON

1404-4601 - 1404-4605

20,5 cm / 8"



scharf
sharp
agudo
acuto

COTTLE

1267-7416 17,0 cm / 6³/₄"



1267-7201

scharf
sharp
agudo
acuto



1267-7202

scharf
sharp
agudo
acuto



1267-7203

scharf
sharp
agudo
acuto



Knopfende
button end
punta abotonada
fine abbottonato

LANGE

1267-7301 22,0 cm / 8³/₄"

Nasenflügelhäkchen
Alar Hooklet
Ganchito para alas de nariz
Uncino per le inne
nasali

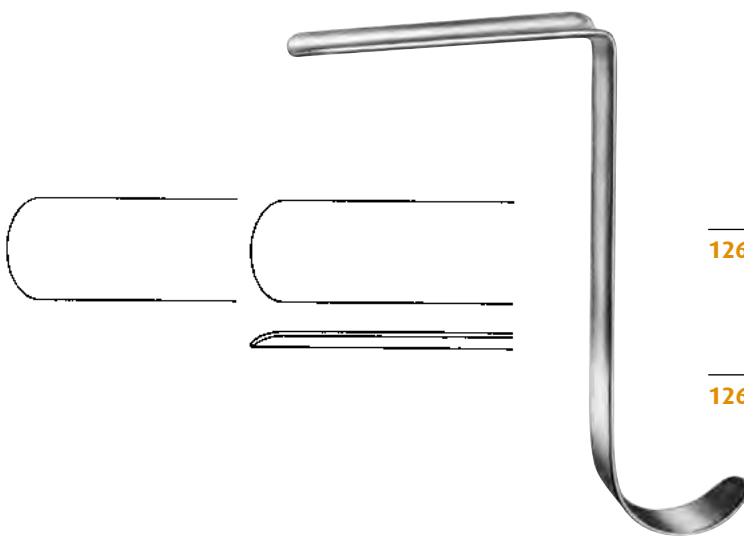

1267-6701 20 x 9 mm

1267-6702 28 x 13 mm

1267-6703 41 x 13 mm

1267-6704 60 x 14 mm

CONVERSE

1267-6701 - 1267-6704 9,0 cm / 3¹/₂"



Knopfende
button end
punta abotonada
fine abbottonato

FOMON

1267-7617 17,0 cm / 7¹/₂"

Nasenflügelhäkchen
Alar Hooklet
Ganchito para alas de nariz
Uncino per le inne
nasali

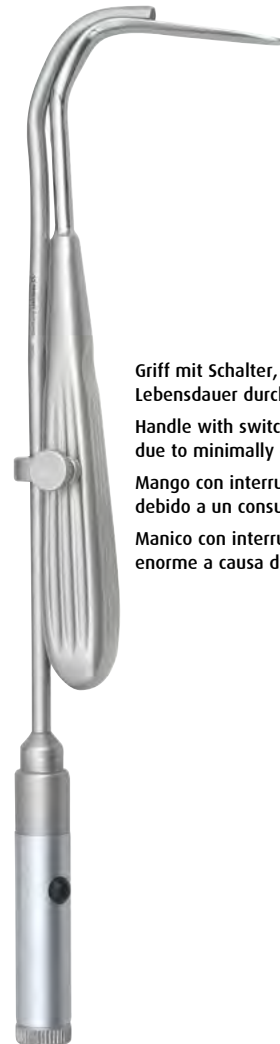

Griff mit Schalter, integrierter Batterie. Extrem lange Lebensdauer durch minimale Stromaufnahme.

Handle with switch, included battery. Substandard lifetime due to minimally current consumption.

Mango con interruptor, batería incluida. Enorme vida útil debido a un consumo mínimo de corriente.

Manico con interruttore, batteria inclusa. La vita utile ed enorme a causa di un minimo consumo di corrente.

1267-8215 21,5 cm / 8¹/₂"

Nasentrückenhaken mit Fiberglas-Lichtträger
Nasal retractor with fiber optic light carrier
Separador nasal con portador de luz fibra óptica
Divaricatore nasale con supporto per illuminazione fibra ottica

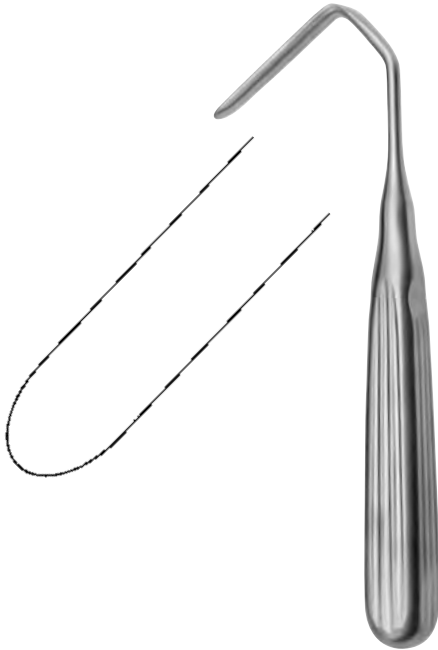
**AUFRICHT**

1267-6716 16,0 cm / 6¹/₄"

**KILNER**

1267-7010 8,0 cm / 3¹/₂"

Nasenflügelhäkchen
Alar Hooklet
Ganchito para alas de nariz
Uncino per le inne
nasali

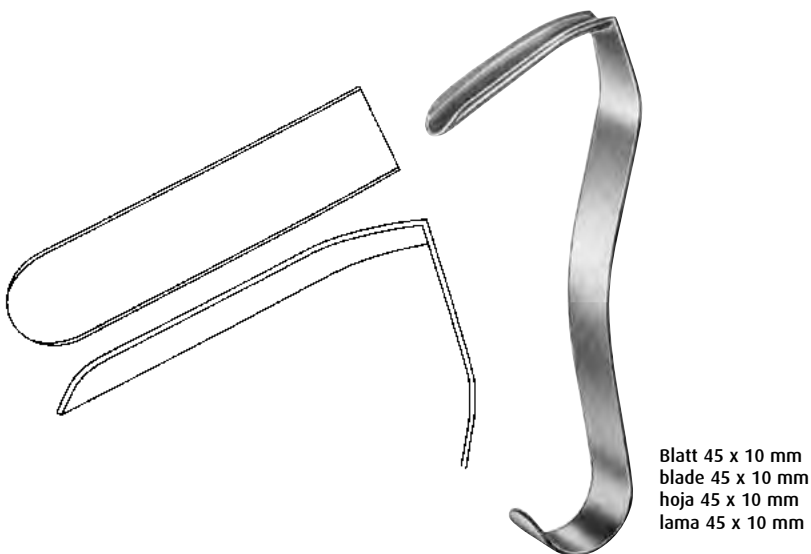
**CONVERSE**

1267-7111 10,5 cm / 4"

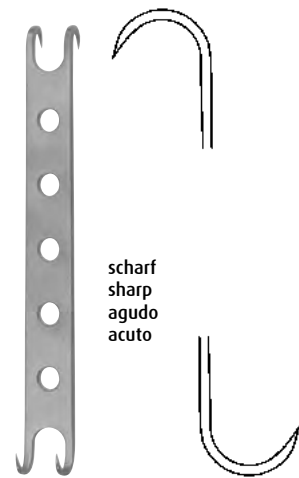
**CONVERSE**

1267-7112 12cm / 4³/₄"

Nasenflügelhäkchen
Alar Hooklet
Ganchito para alas de nariz
Uncino per le inne
nasali

Nasenhäkchen
Nasal Hooks
Ganchitos nasales
Uncini nasali



scharf
sharp
agudo
acuto

FREER

1161-5615 15,0 cm / 6"



JOSEPH

1161-5401 15,0 cm / 6"

Schleimhauthäkchen
Mucosa Hooklet
Ganchito para mucosa
Uncino per mucosa



JOSEPH

1161-5402 - 1161-5405 16,0 cm / 6 1/4"

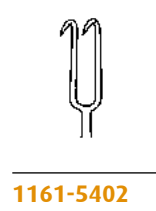

1161-5402

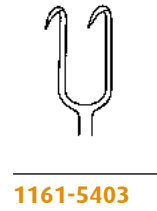

1161-5403

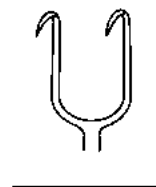

1161-5404

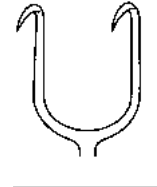

1161-5405

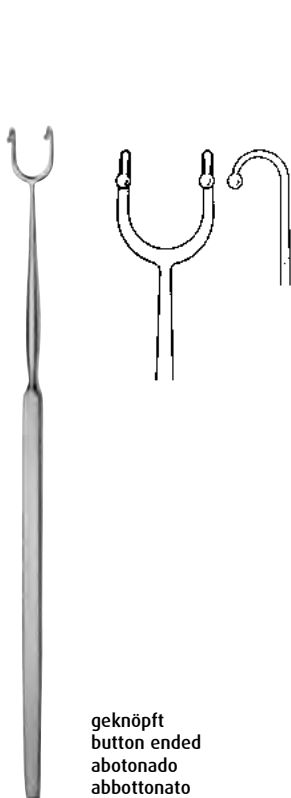

geknöpft
button ended
abotonado
abbottonato

FOMON

1267-7916 16,0 cm / 6 1/4"



geknöpft
button ended
abotonado
abbottonato

COTTLE-NEIVERT

1267-8020 20,0 cm / 8"



1267-7801

scharf
sharp
agudo
acuto

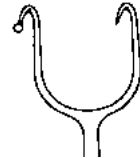

1267-7802

geknöpft / scharf
button end / sharp
abotonado / agudo
abbottonato / acuto



1267-7803

scharf / geknöpft
sharp / button end
agudo / abotonado
acuto / abbottonato

COTTLE

1267-7801 - 1267-7803 14,5 cm / 5 3/4"

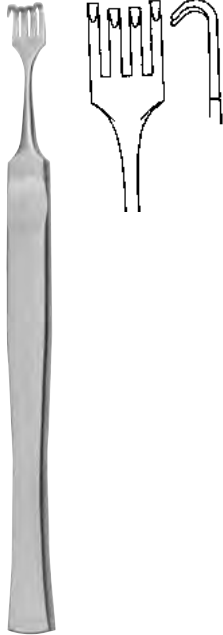

COTTLE
1267-7804 14,0 cm / 5 1/2"



NEIVERT
1267-8216 17,0 cm / 6 3/4"



COTTLE
1267-8515 14,0 cm / 5 1/2"
 Sattelhäkchen
 Saddle Hook
 Separador en forma de silla
 Elevatori in forma di sella



COTTLE
1267-8516 16,0 cm / 6 1/4"



Blatt
 blade
 hoja
 lama
 60 x 6,5 mm

stumpf
 blunt
 romo
 smusso

AUFRICHT
1267-8512 12,0 cm / 4 3/4"

Septumzangen, Septumrichtzangen, Hautfasspinzetten

Septum Forceps, Septum Straightening Forceps, Skin Grasping Forceps

Pinzas para tabique nasal, Pinzas para enderezar el tabique nasal, Pinzas para piel

Pinze per il setto nasale, Pinze per raddizzare il setto nasale, Pinze per afferrare la pelle

035

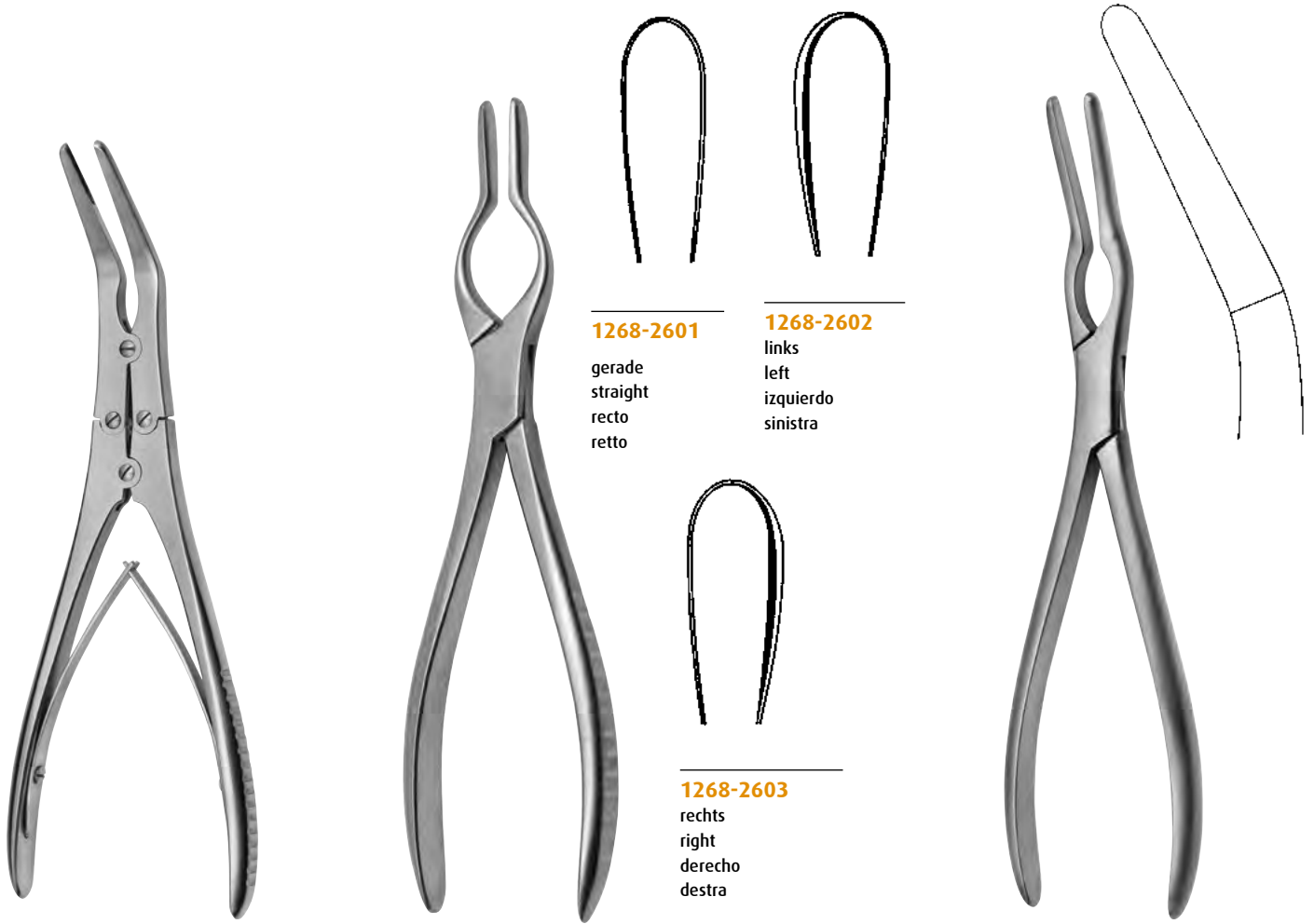

1268-2601

gerade
straight
recto
retto

1268-2602

links
left
izquierdo
sinistra

1268-2603

rechts
right
derecho
destra

KRESSNER

1268-2903 21,0 cm / 8¹/₄"

COTTLE-WALSHAM

1268-2601 - 1268-2603 23,0 cm / 9"

ASCH

1268-2522 22,5 cm / 8³/₄"



1,7 mm breit mit Zähnen
1,7 mm wide with teeth
1,7 mm de ancho con dientes
largo 1,7 mm con denti

COTTLE

1267-6114 14,0 cm / 5¹/₂"

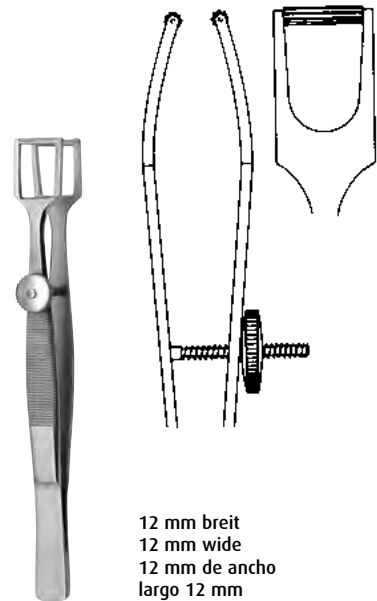

12 mm breit
12 mm wide
12 mm de ancho
largo 12 mm

COTTLE

1267-6010 11,0 cm / 4¹/₄"



FAULKNER

1267-8721 21,0 cm / 8¹/₄"



COAKLEY

1267-9001 - 1267-9006

1267-9001

1267-9002



1267-9003



1267-9004



1267-9005



1267-9006

17,0 cm / 6³/₄"



BECKMANN

1261-8101 - 1261-8106 22,0 cm / 8³/₄"

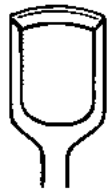

FIG. 1

1261-8101 10 mm



FIG. 2

1261-8102 12 mm

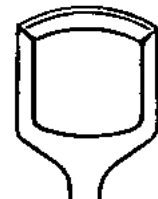

FIG. 3

1261-8103 14 mm

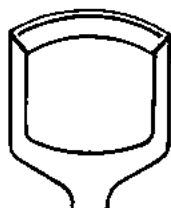

FIG. 4

1261-8104 16 mm

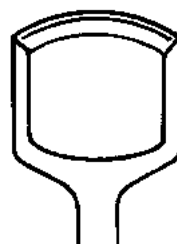

FIG. 5

1261-8105 20 mm

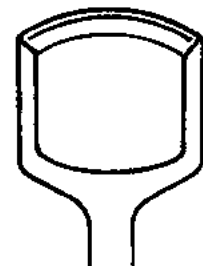

FIG. 6

1261-8106 22 mm

Ringmesser
Adenoid Currettes
Cuchillos para adenoides
Coltelli per vegetazioni adenoidee



trapezförmig gefenstert
 trapezoidal fenestrated
 fenestrado trapecialmente
 fenestrato a forma di trapezio

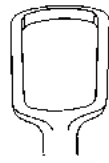

FIG. 1
1261-80011 10 mm

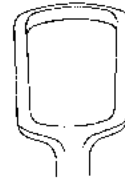

FIG. 2
1261-8002 14 mm

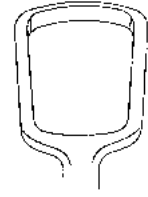

FIG. 3
1261-8003 16 mm

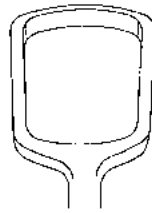

FIG. 4
1261-8004 18 mm

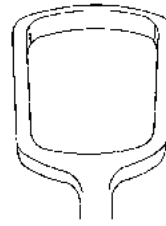

FIG. 5
1261-8005 20 mm

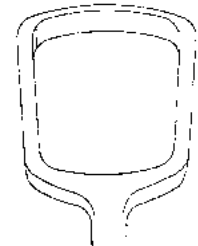

FIG. 6
1261-8006 22 mm

BECKMANN

1261-8001 - 1261-8006 22,0 cm / 8³/₄"

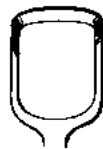

FIG. 1
1261-8401 16 mm



FIG. 2
1261-8402 18 mm



FIG. 3
1261-8403 20 mm

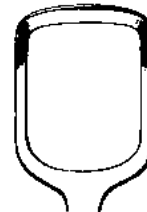

FIG. 4
1261-8404 23 mm

BARNHILL

1261-8401 - 1261-8404 21,0 cm / 8¹/₄"

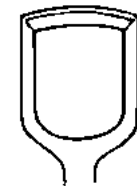

FIG. 1
1261-8601

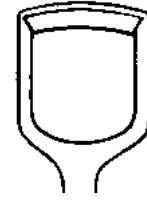

FIG. 2
1261-8602

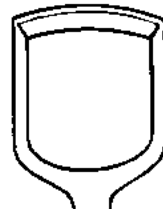

FIG. 3
1261-8603

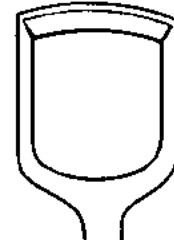

FIG. 4
1261-8604

ST. CLAIR-THOMSON

1261-8601 - 1261-8604 21,0 cm / 8 1/4"



FIG. 1
1261-8701



FIG. 2
1261-8702

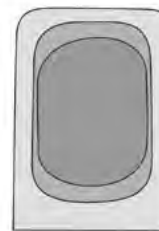

FIG. 3
1261-8703

mit gelochter Klinge
with perforated blade
con hoja perforada
con lama forato

Ersatzklingen
Spare Blades
Hojas de repuesto
Lame di ricambio

FIG. 1
1261-8711

FIG. 2
1261-8712

FIG. 3
1261-8713

LA FORCE

1261-8701 - 1261-8703 25,0 cm / 10"

Spülkatheter, Sinus-Dilatatoren
Antrum Irrigation Cannulas, Frontal Sinus Dilators
Catéteres lavadores , Dilatadores para el seno
Cateteri per lavaggio, Dilatatori per il seno frontale



EICKEN-KILLIAN

1109-5730 14,0 cm / 5¹/₂"



GUILEN

1267-0020 19,0 cm / 7¹/₂"

Saugraspatorium
 Suction Raspatory
 Legra de succión
 Raspatorio con aspiratore

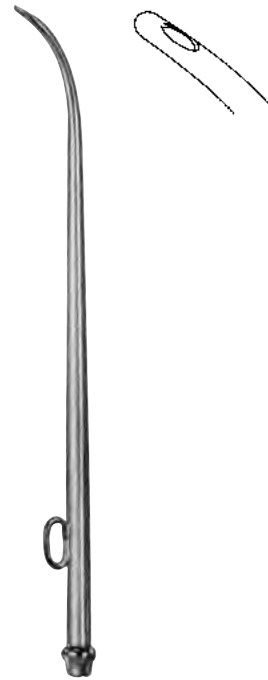

SIEBENMANN

1109-5916	15,0 cm / 6"	Ø 1,5 mm
1109-5918	15,0 cm / 6"	Ø 1,7 mm
1109-5921	15,0 cm / 6"	Ø 2,0 mm
1109-5926	15,0 cm / 6"	Ø 2,5 mm
1109-5931	15,0 cm / 6"	Ø 3,0 mm



RITTER-HALLE

1275-6102	14,5 cm / 5 ³ / ₄ "	Ø 2,5 mm
1275-6103	14,5 cm / 5 ³ / ₄ "	Ø 3,0 mm
1275-6105	14,5 cm / 5 ³ / ₄ "	Ø 4,0 mm
1275-6105	14,5 cm / 5 ³ / ₄ "	Ø 5,0 mm



UNIVERSAL

1276-6000

mit beweglicher Düse, Flasche und Halbgebläse
with adjustable nozzle bottle and rubber bulb
con tobera mòvil frasco y per de goma
con ugello mobile bottiglia e pera di gomma



1276-6002

Ersatzflasche
Spare Bottle
Frasco de repuesto
Bottiglia di ricambio

UNIVERSAL

1276-6001

wie Art.-Nr. 1276-6000 jedoch ohne Halbgebläse
as ref. 1276-6000 without rubber bulb
como ref. 1276-6000 pero sin pera de goma
come rif. 1276-6000 però senza pera di gomma

037

Mund-, Kiefer- und Gesichtschirurgie
Oral Maxillo-Facial Surgery
Cirugía oral y maxilofacial
Chirurgia maxillo-facciale





ADAMS

1260-7700



LANGENBECK

1260-7901



LANGENBECK

1260-7902



LANGENBECK

1260-7903

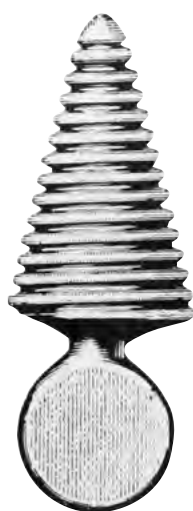

MAUNDER

1260-7510 10,0 cm / 4"



PITHA

1260-7610



HEISTER
 1260-2213 13,0 cm / 5"



MOLT / DOYEN-JANSEN
 1260-2512 11,0 cm / 4 1/2"

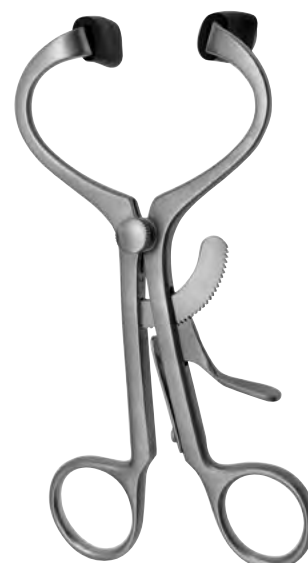

DOYEN-JANSEN
 1260-2614 14,0 cm / 5 1/2"



DENHART
 1260-2813 12,0 cm / 4 3/4"

1260-2898

Silikonbacken, allein (Paar)
 Silicon jaws, only (pair)
 Bocas de silicona, sueltas (par)
 Bocca da silicona, sola (paio)

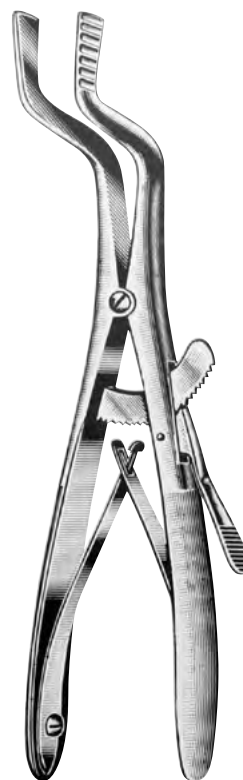

ROSER-KÖNIG
 1260-2916 16,0 cm / 6 1/4"
 1260-2919 20,0 cm / 8"



Bruststütze mit Band
Chest support with band
Soporte de pecho con cinta
Supporto per petto con filo

NEGUS

1260-6000



FIG. 1 29 x 70 mm
1260-5001 13,5 cm / 5 1/4"



FIG. 2 34 x 80 mm
1260-5002 13,5 cm / 5 1/4"



1260-4419

Mundsperrer-Rahmen
Frame for Mouth Gag
Bastidor para abreboaca
Telaio per apribocca

KILNER-DOUGHTY

1260-4400

komplett, bestehend aus Rahmen und 3 Zungenspatel Fig. 1 bis 3, 2 Zahnplatten und 1 Gaumenplatte
complete, consisting of frame and 3 tongue depressors no. 1 to 3, 2 tooth plates and 1 palate plate
completo, consiste de bastidor y 3 babajalenguas no. 1 hasta 3, 2 placas para dientes y 1 placa paladar
completo, composto di telaio e 3 abassalingua no. 1 fino a 3, 2 placche per denti e 1 placa per palato



FIG. 3 38 X 85 mm
1260-5003 13,5 cm / 5 1/4"

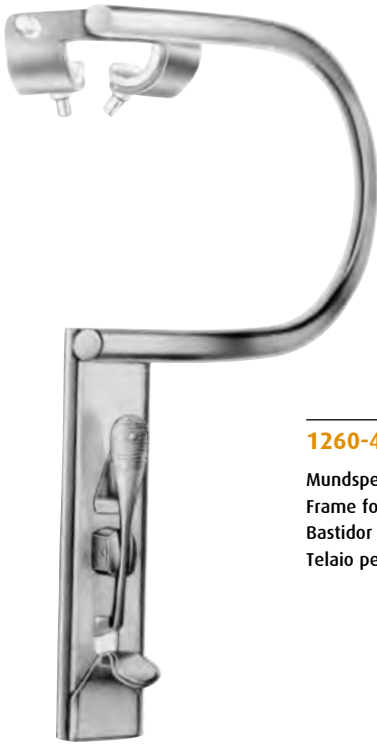

1260-4102

Mundsperrer-Rahmen
 Frame for Mouth Gag
 Bastidor para abrebooca
 Telaio per apribocca



DAVIS-BOYLE

1260-5505 13,5 cm / 5¹/₄" 25 x 108 mm

Zungenspatel mit fester Absaugung
 Tongue Depressor with fixed suction tube
 Bajalengua con tubo de succión fijo
 Abassalingua con tubo di aspirazione fisso

DAVIS-BOYLE

1260-4101

komplett, bestehend aus Rahmen und fünf Zungenspatel Fig. 1 bis 5
 complete, consisting of frame and five tongue depressors no. 1 to 5
 completo, consiste de bastidor y cinco babajalenguas no. 1 hasta 5
 completo, composto di telaio e cinque abassalingua no. 1 fino a 5



DAVIS-BOYLE

1260-5504 13,5 cm / 5¹/₄" 25 x 95 mm

Zungenspatel mit fester Absaugung
 Tongue Depressor with fixed suction tube
 Bajalengua con tubo de succión fijo
 Abassalingua con tubo di aspirazione fisso



DAVIS-BOYLE

1260-5503 13,5 cm / 5¹/₄" 24 x 80 mm

Zungenspatel mit fester Absaugung
 Tongue Depressor with fixed suction tube
 Bajalengua con tubo de succión fijo
 Abassalingua con tubo di aspirazione fisso



DAVIS-BOYLE

1260-5502 13,5 cm / 5¹/₄" 23 x 65 mm

Zungenspatel mit fester Absaugung
 Tongue Depressor with fixed suction tube
 Bajalengua con tubo de succión fijo
 Abassalingua con tubo di aspirazione fisso



DAVIS-BOYLE

1260-5501 13,5 cm / 5¹/₄" 20 x 30 mm

Zungenspatel ohne Absaugung
 Tongue Depressor without suction tube
 Bajalengua sin tubo de succión fijo
 Abassalingua senza tubo di aspirazione fisso



MC IVOR

1260-5401

Mundsperrer-Rahmen
Frame for Mouth Gag
Bastidor para abrebooca
Telaio per apribocca

MC IVOR

1260-4501

komplett mit drei Zungenspatel
complete with three tongue depressors
completo con tres babajalenguas
completo e tre abassalingua



MC IVOR

1260-5501 13,5 cm / 5 1/2" 26 x 100 mm

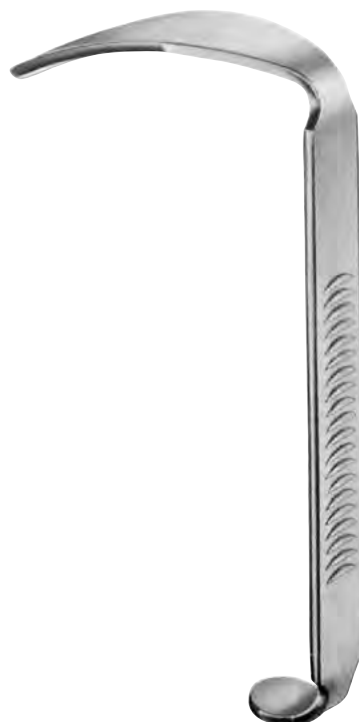

MC IVOR

1260-5502 13,5 cm / 5 1/2" 25 x 85 mm

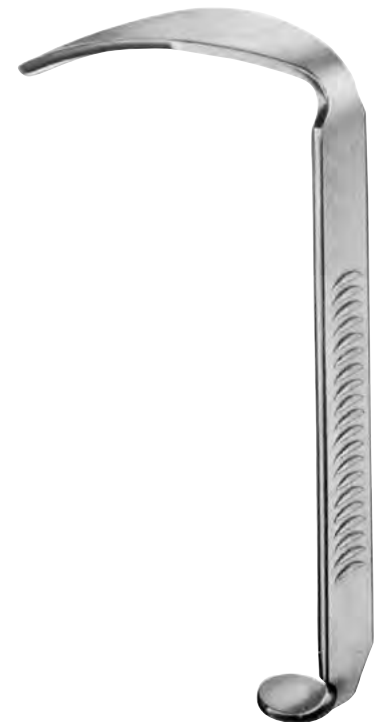

MC IVOR

1260-5503 13,5 cm / 5 1/2" 23 x 75 mm

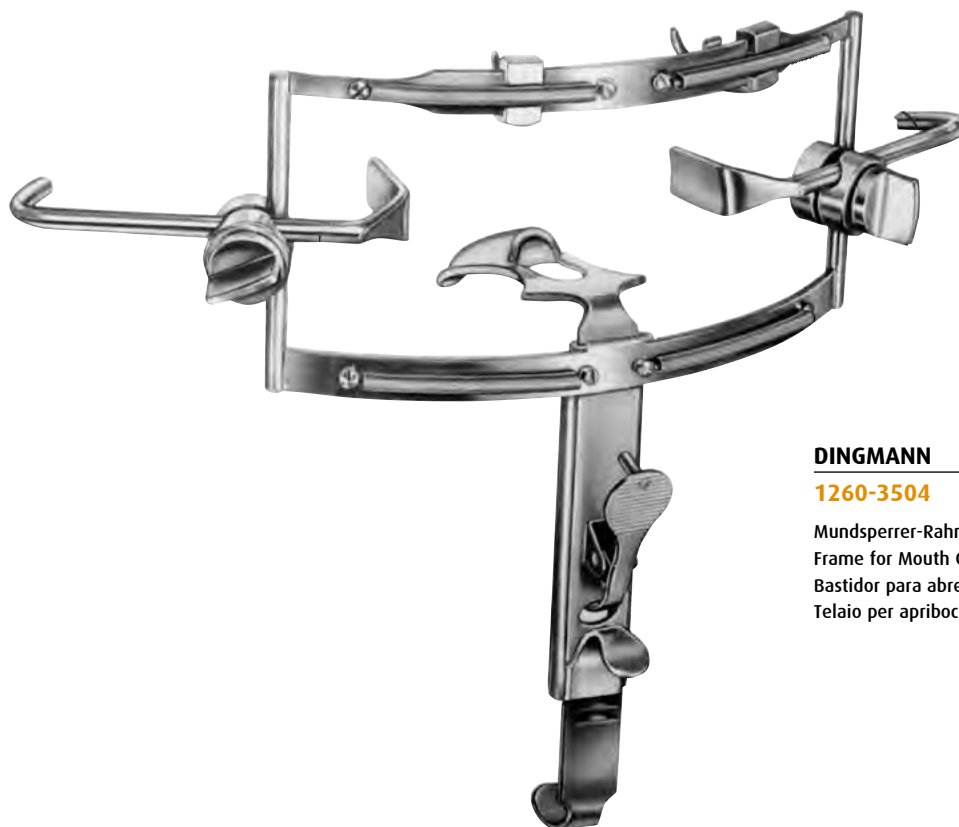

DINGMANN

1260-3504

Mundsperrer-Rahmen
Frame for Mouth Gag
Bastidor para abrebooca
Telaio per aprobocca

DINGMANN

1260-3500

komplett mit Rahmen, 3 Zungenspateln und 2 beweglichen Seitenvalven
Complete with frame, 3 tongue depressors and 2 adjustable lateral blades
Completo con bastidor, 3 bajalenguas y 2 valvas laterales ajustables
completo con telaio, 3 abassalingua e 2 valve laterali movibili

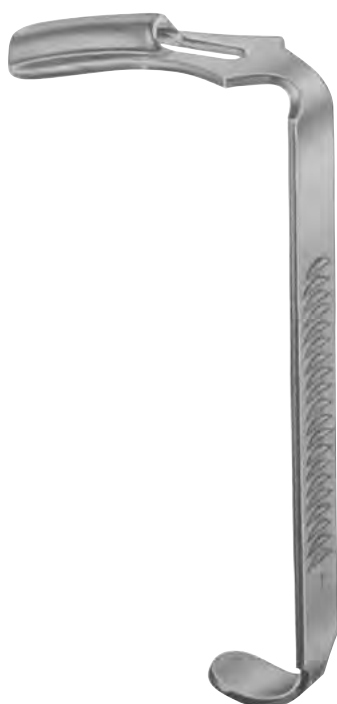

DINGMANN

1260-3501 13,5 cm / 5 1/2" 25 x 65 mm



DINGMANN

1260-3502 13,5 cm / 5 1/2" 29 x 70 mm



DINGMANN

1260-3503 13,5 cm / 5 1/2" 32 x 80 mm

**WHITEHEAD**

1260-3211	11,0 cm / 4 ¹ / ₄ "
1260-3213	13,0 cm / 5"
1260-3215	15,0 cm / 6"

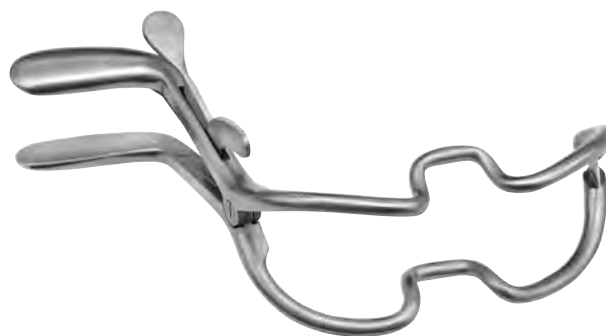
**JENNINGS**

1260-3309	9,0 cm / 3 ¹ / ₂ "
1260-3311	11,0 cm / 4 ¹ / ₄ "
1260-3313	13,0 cm / 5"
1260-3315	15,0 cm / 6"

Wangen- und Lippenhalter, Zungendrücker
 Cheek and Lip Retractors, Tongue Depressors
 Separadores para mejillas y labios, Abajalenguas
 Divaricatori per guanci e labbra, Abbassalingua

037



SIMPLEX

1260-7411 11,0 cm / 4 1/2"



STERNBERG

1260-7012 12,0 cm / 4 3/4"
 1260-7014 14,0 cm / 5 1/2"
 1260-7016 16,0 cm / 6 1/4"



1260-7119 19,0 cm / 7 1/2"

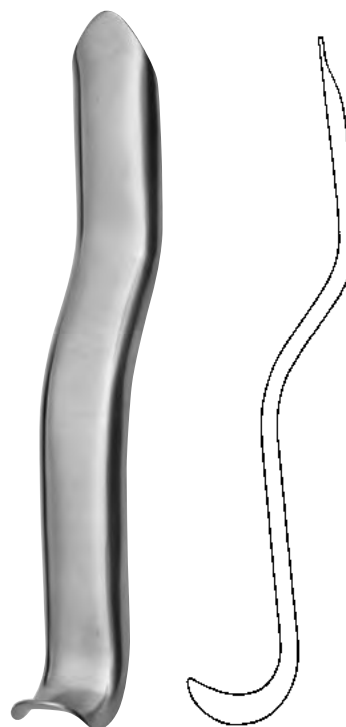

CAWOOD-MINNESOTA

1260-6915 15,5 cm / 6"



HARTMANN
 1260-1115 15,0 cm / 6"



TOBOLD
 1260-1015 14,5 cm / 5 1/2"



TOBOLD
 1260-1014 14,5 cm / 5 1/2"

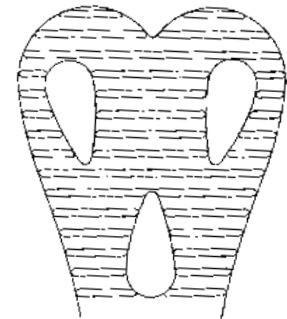

1260-1701 14,0 cm / 5 1/2"



ANDREW
 1260-1703 11,0 cm / 4 3/8"



WIEDER
 1260-1701 - 1260-1702

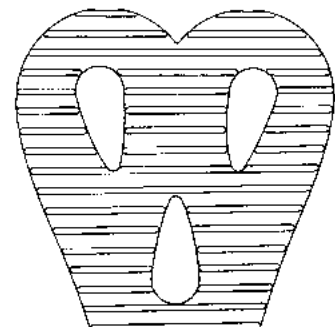

1260-1702 15,0 cm / 6"

Zungenspatel
Tongue spatulas
Espátulas linguales
Spatole per lingua

037

Packung á 100 Stk.
package of 100 pcs.
paquete con 100 piezas
confezione di 100 pezzi



aus Holz
from wood
de madera
di legno

1260-0516 16,0 cm / 6¹/₄"

Packung á 100 Stk.
package of 100 pcs.
paquete con 100 piezas
confezione di 100 pezzi



aus Kunststoff
from plastic
de plástico
di plastica

1260-0515 15,0 cm / 6"



BUCHWALD

1260-0517 19,0 cm / 7¹/₂"



BRUENINGS

1260-0619 19,0 cm / 7¹/₂"



1260-0014 14,5 cm / 5³/₄"

**COLLIN**

1260-7216 16,0 cm / 6¹/₄"
1260-7218 18,0 cm / 7"

**YOUNG**

1260-7316 16,0 cm / 6¹/₄"

**1260-7399**

Gummibacken, allein (Paar)
Rubber inserts, only (pair)
Bocas de goma, sueltas (par)
Cuscino di gomma, soli (paio)

Weichteilhaken
Soft Tissue Retractors
Separadores para partes blandas
Separatori per tessuti molli

037



OBWEGESER

1160-2203 - 1160-2206

22,0 cm / 8³/₄"

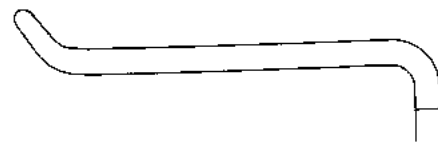

1160-2203 11 x 40 mm



1160-2204 11 x 55 mm



1160-2206 16 x 80 mm

037

Ramushaken
Ramus Retractors
Separadores para el ramo
Separatore per ramo

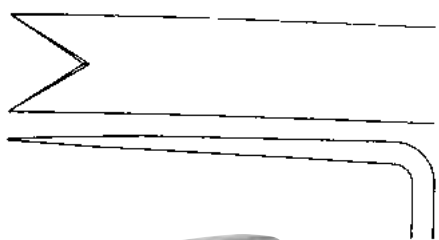

OBWEGESER

1160-2242 22,0 cm / 8³/₄" 10 x 45 mm

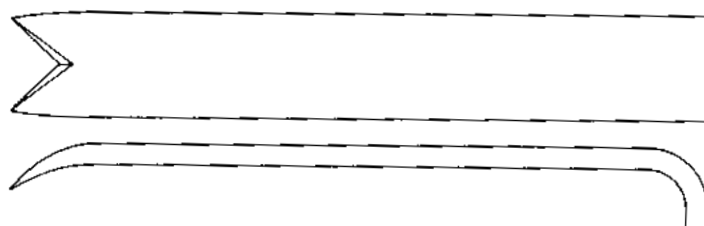

OBWEGESER

1160-2243 22,0 cm / 8³/₄" 11 x 70 mm



OBWEGESER

1160-0210 16,0 cm / 6¹/₂"



OBWEGESER

1403-7308 17,0 cm / 6³/₄" 8 mm
1404-7310 17,0 cm / 6³/₄" 10 mm



1403-7506 6 mm



1403-7507 7 mm



1403-7509 9 mm



1403-7511 11 mm

OBWEGESER

1403-7506 - 1403-7511 17,5 cm / 7 1/4"



1403-7705 5 mm



1403-7707 7 mm

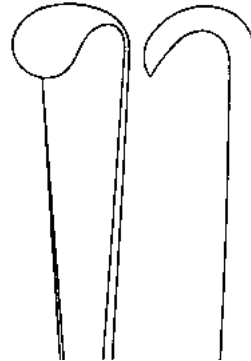

1403-7709 9 mm

OBWEGESER

1403-7705 - 1403-7709 20,0 cm / 8"

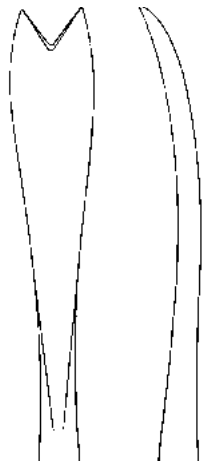
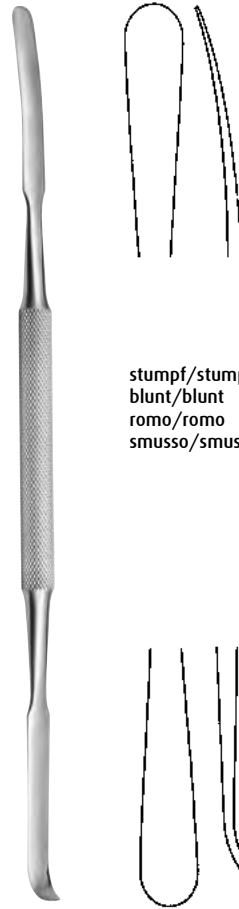

Fig. 1
 1403-7401

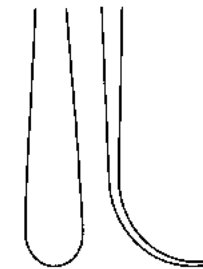

Fig. 2
 1403-7402

OBWEGESER
 1403-7401 - 1403-7402 17,5 cm / 7"



stumpf/stumpf
 blunt/blunt
 romo/romo
 smusso/smusso



OBWEGESER Fig. 1
 1403-6700 21,0 cm / 8 1/2"



scharf/stumpf
 sharp/blunt
 agudo/romo
 acuto/smusso



OBWEGESER Fig. 2
 1403-6701 21,0 cm / 8 1/2"



1403-1403 2,5 mm



1403-1404 4,0 mm

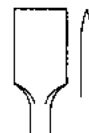

1403-1406 6,5 mm

OBWEGESER
 1403-1403 - 1403-1406 15,0 cm / 6"

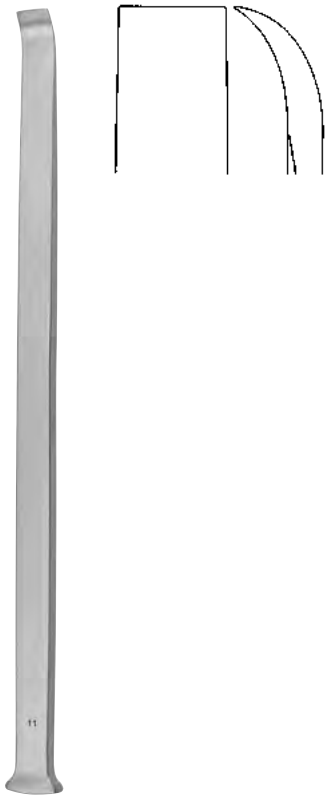

OBWEGESER
 1402-9501 23,5 cm / 9 1/4"

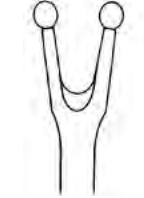

1402-9726



1402-9724

OBWEGESER
 1402-9726 - 1402-9724 18,5 cm / 7 1/4"



OBWEGESER
 1177-0918 18,0 cm / 7"



OBWEGESER
 1177-0814 14,0 cm / 5 1/2"



OBWEGESER
 1177-0823 23,0 cm / 9"

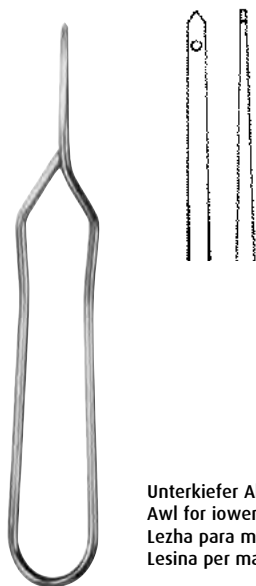

Unterkiefer Ahle
Awl for lower jaw
Lezha para maxilar inferior
Lesina per mascella inferiore

KELSEY-FRY

1177-0815 15,0 cm / 6"

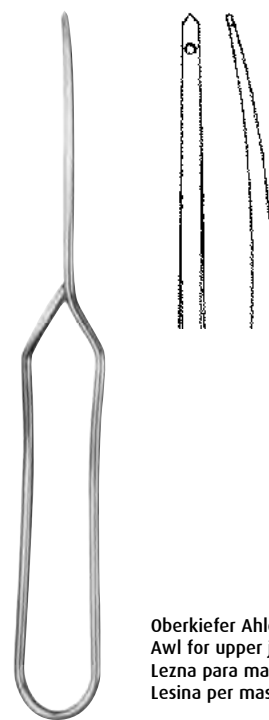

Oberkiefer Ahle
Awl for upper jaw
Lezna para maxilar superior
Lesina per mascella superiore

KELSEY-FRY

1177-0818 18,0 cm / 7¹/₄"



links
 left
 izquierda
 sinistra

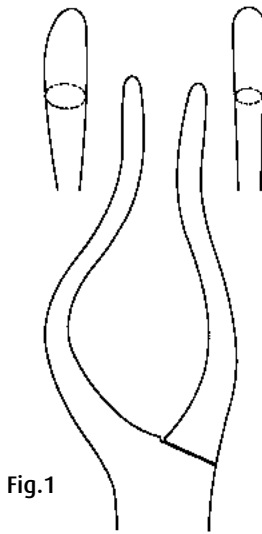

Fig.1

für Babys
 for babies
 para bebés
 per neonati

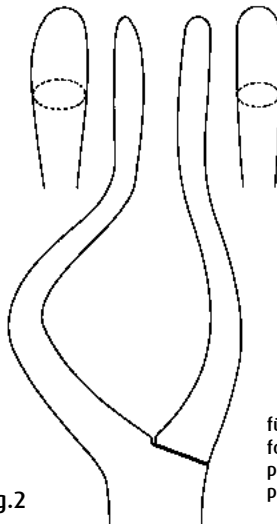

Fig.2

für Kinder
 for children
 para niños
 per bambini

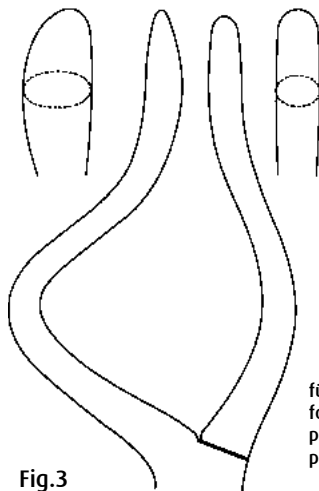

Fig.3

für Erwachsene
 for adults
 para adultos
 per adulti



rechts
 right
 derecha
 destra

ROWE

1177-1001	Fig. 1	22,5 cm
1177-1002	Fig. 2	23,5 cm
1177-1003	Fig. 3	24,0 cm

ROWE

1177-3001	Fig. 1	22,5 cm
1177-3002	Fig. 2	23,5 cm
1177-3003	Fig. 1	24,0 cm

Nadeln zur Gaumennaht, Tonsillennadeln
Cleft Palate Needles, Tonsil Needles
Agujas para sutura del paladar, agujas para amígdalas
Aghi per sutura del palato, Aghi per tonsille

037



für rechte Hand
 for right hand
 para mano derecha
 per mano destra



für linke Hand
 for left hand
 para mano izquierda
 per mano sinistra



für rechte Hand
 for right hand
 para mano derecha
 per mano destra



für linke Hand
 for left hand
 para mano izquierda
 per mano sinistra

HURD

1261-6521 21,0 cm / 8¹/₄"

HURD

1261-6321 21,0 cm / 8¹/₄"

DUPUY WEISS

1261-6922 22,0 cm / 8³/₄"

DUPUY WEISS

1261-7122 22,0 cm / 8³/₄"

**FISCHER**

1103-7120 22,5 cm / 9"

**ABRAHAM**

1103-7121 21,0 cm / 8¹/₄"

**BRUENINGS**

1103-7122 23,0 cm / 9"

Tonsillendissektoren
Tonsil Dissectors
Disector para amígdalas
Disettori per tonsille

037



CARPENTER

1261-0001 25,0 cm / 10"



CARPENTER

1261-0002 24,0 cm / 9¹/₂"



HURD

1261-0101 22,5 cm / 9"

037

Tonsillendissektoren
Tonsil Dissectors
Disector para amígdalas
Disettori per tonsille

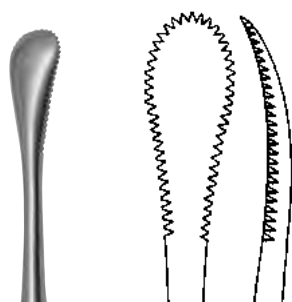

HENKE

1261-0201 23,0 cm / 9"

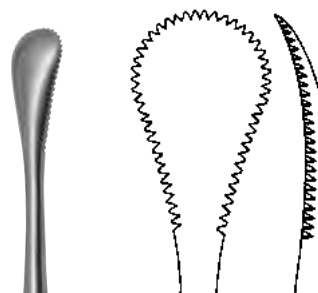

HENKE

1261-0202 23,0 cm / 9"

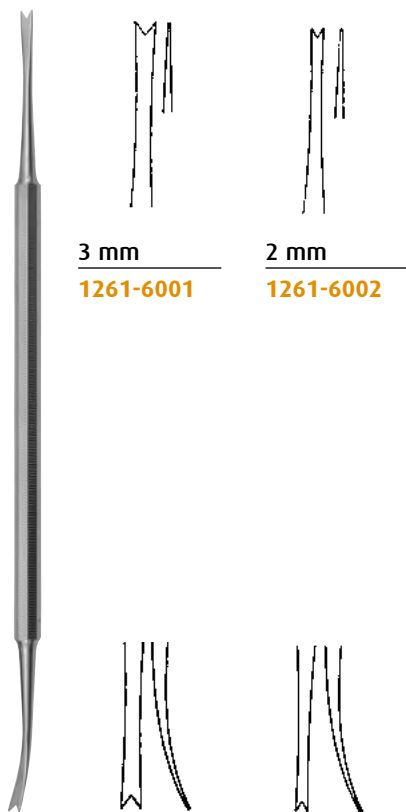

LUNIATSCHEK

1261-6001 - 1261-6002

17,5 cm / 6³/₄"

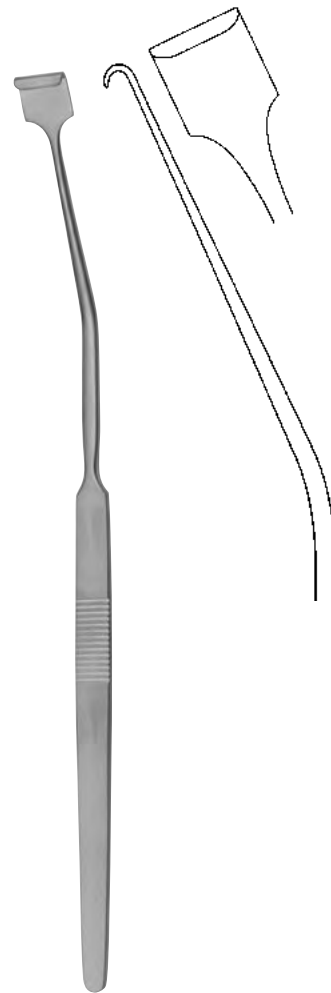

NAGER

1261-7523

24,0 cm / 9"

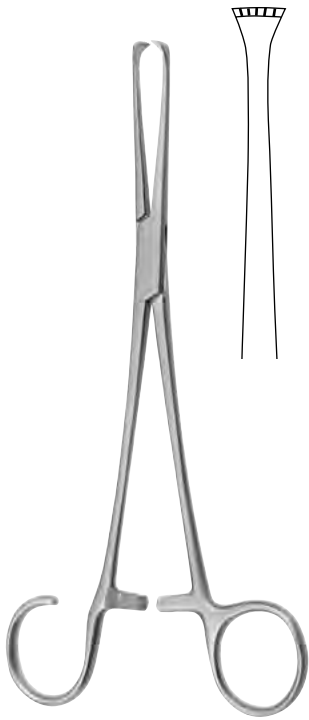

WHITE (COLVER)

1260-8219 19,0 cm / 7 1/2"



WHITE (COLVER)

1260-8518 18,0 cm / 7"



WHITE

1260-8319 18,0 cm / 7"
1260-8523 23,0 cm / 9"

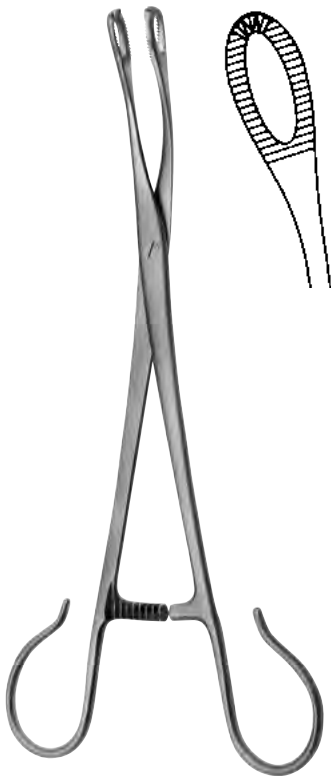

BLOHMKE

1260-9320 20,0 cm / 8"

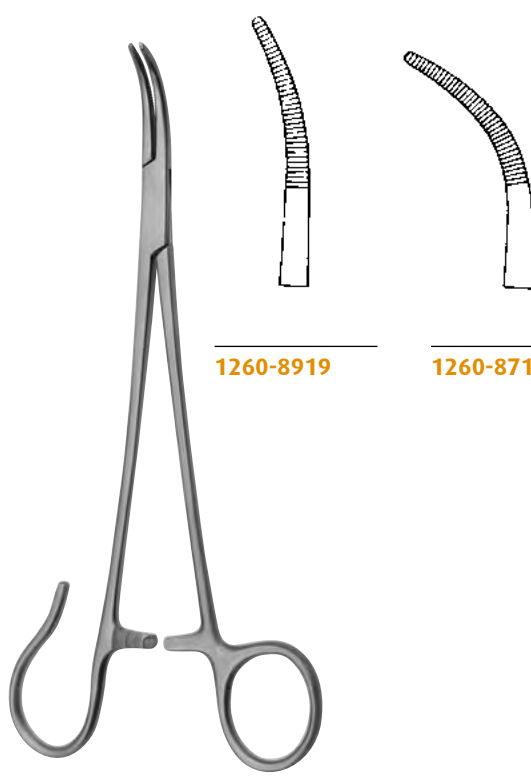

1260-8919

1260-8718

SCHNIDT

1260-8919 - 1260-8718 19,0 cm / 7 1/2"

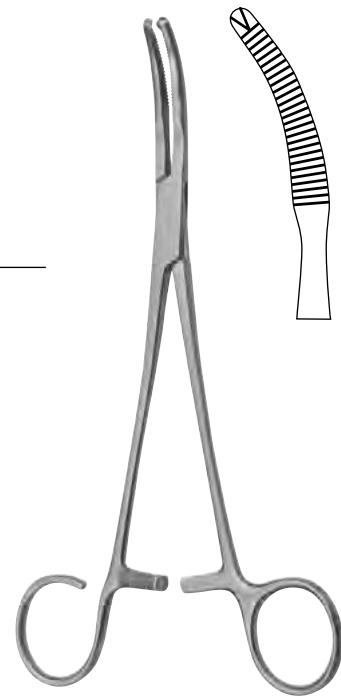

MIKULICZ

1153-4319 18,5 cm / 7 1/4"

Tonsillenschnürer
Tonsil Snares
Cierra - nudos para amígdalas
Serranodi per tonsille



Packung à 100 Stk.
 package with 100 pcs.
 paquete de 100 piezas
 confezione di 100 pezzi



Bündel mit 12 Stk.
 bundle with 12 pcs.
 manojo de 12 piezas
 manello di 12 pezzi



EVES

1261-5026 28,0 cm / 11"

1261-5704 40 mm
1261-5705 50 mm

1261-5603 Ø 0,35 mm
1261-5640 Ø 0,40 mm
1261-5645 Ø 0,45 mm
1261-5605 Ø 0,50 mm

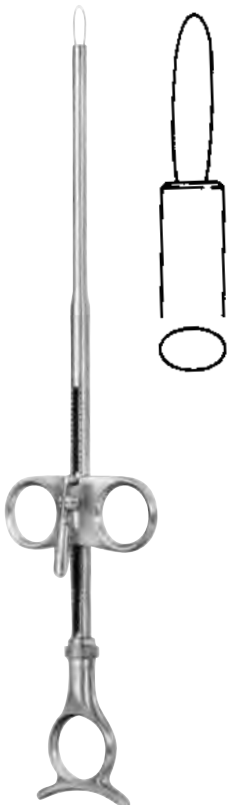

EVES

1261-5225 28,0 cm / 11"

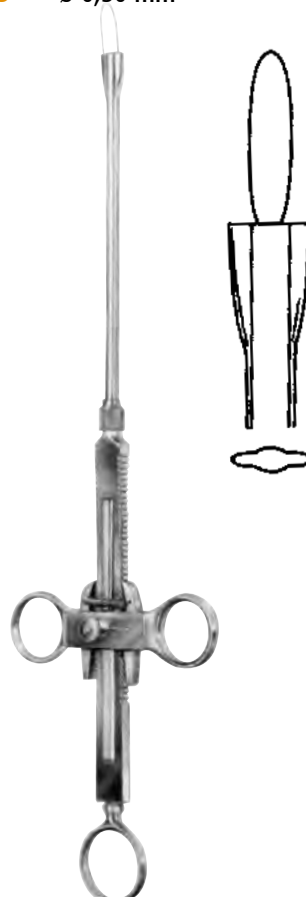

BRUENINGS

1261-5427 28,0 cm / 11"



RÖDER

1261-7226 26,5 cm / 10 1/2"

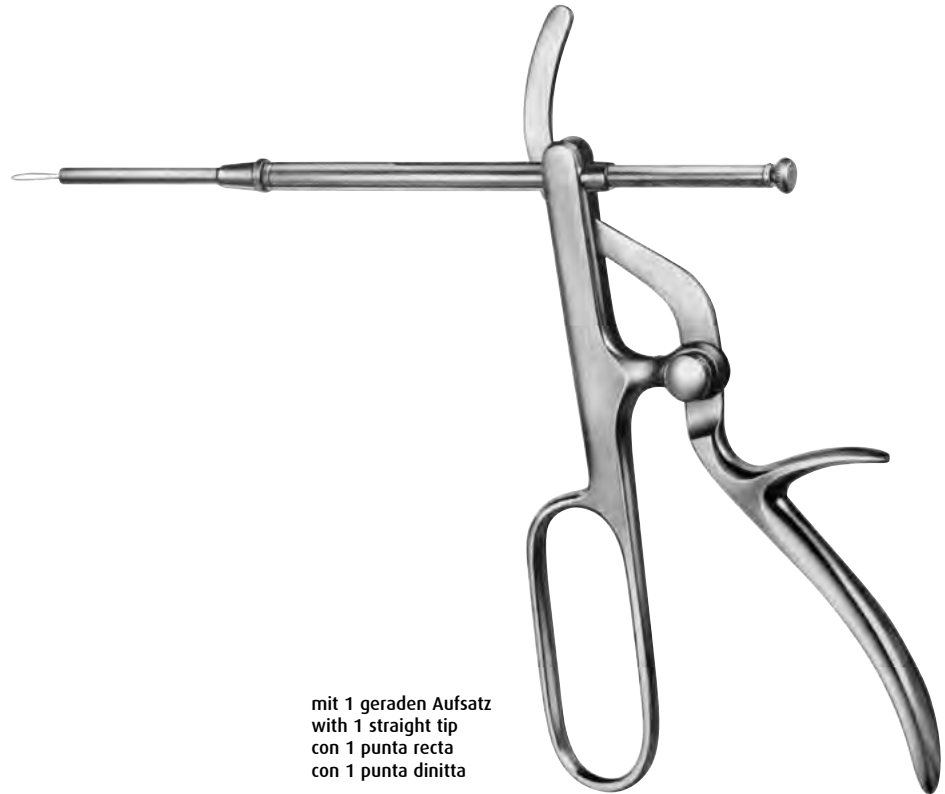

mit 1 geraden Aufsatz
with 1 straight tip
con 1 punta recta
con 1 punta dritta

TYDING

1261-5500

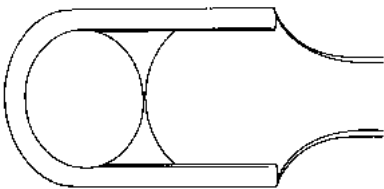

SLUDDER-BALLENGER

1261-5901 Fig.1

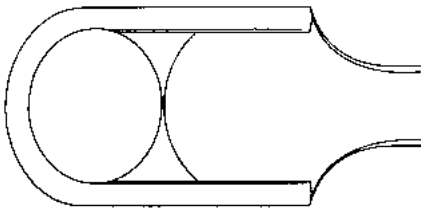

SLUDDER-BALLENGER

1261-5902 Fig.2

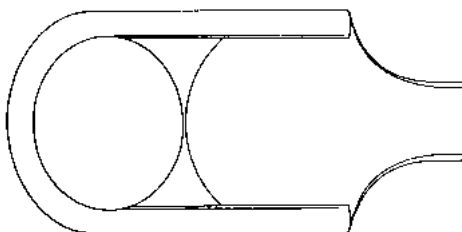

SLUDDER-BALLENGER

1261-5903 Fig.3



SLUDDER-BALLENGER

1261-5904

Griff alleine
handle only
mango suelto
manico solo

SLUDDER-BALLENGER

1261-5900

komplett mit 3 Aufsätzen
complete with 3 tips
completo con 3 puntas
completo con 3 punti

Tonsillenzange
Tonsil Punches
Pinzas para amígdalas
Pinze per tonsille

037

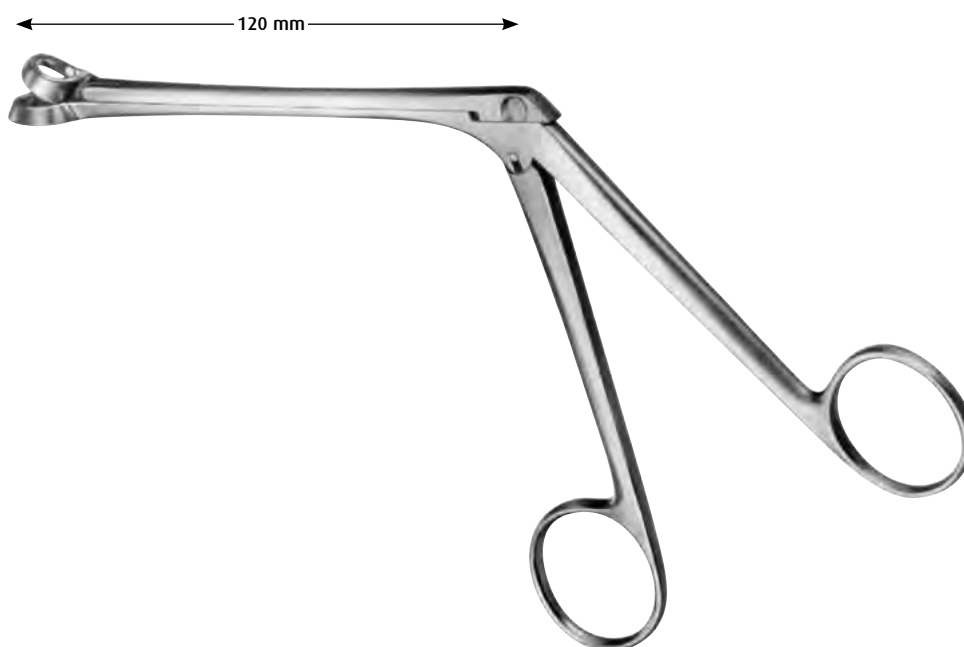

HARTMANN

1400-4013 - 1400-4017

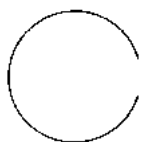

1400-4013 **Ø 13 mm**

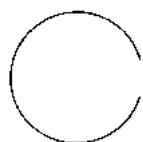

1400-4015 **Ø 15 mm**

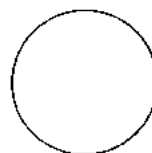

1400-4017 **Ø 17 mm**



CHEVALIER-JACKSON
1264-1030 - 1264-1660



Fig. 1
1264-1030 30,0 cm
1264-1040 40,0 cm
1264-1050 50,0 cm
1264-1060 60,0 cm



Fig. 2
1264-1130 30,0 cm
1264-1140 40,0 cm
1264-1150 50,0 cm
1264-1160 60,0 cm



Fig. 3
1264-1230 30,0 cm
1264-1240 40,0 cm
1264-1250 50,0 cm
1264-1260 60,0 cm



Fig. 4
1264-1330 30,0 cm
1264-1340 40,0 cm
1264-1350 50,0 cm
1264-1360 60,0 cm



Fig. 5
1264-1430 30,0 cm
1264-1440 40,0 cm
1264-1450 50,0 cm
1264-1460 60,0 cm



Fig. 6
1264-1530 30,0 cm
1264-1540 40,0 cm
1264-1550 50,0 cm
1264-1560 60,0 cm



Fig. 7
1264-1630 30,0 cm
1264-1640 40,0 cm
1264-1650 50,0 cm
1264-1660 60,0 cm



HUBER
1262-6200
 Universal-Griff
 Universal Handle
 Mango universale
 Manico universale



BRUENINGS
1262-6220 20,0 cm / 8"
1262-6230 30,0 cm / 12"
1262-6240 40,0 cm / 16"

Verlängerungsrohr für Handgriff Art.-Nr. 1262-6200
 Interchangeable Tube for handle ref. 1262-6200
 Tubo de extensión para mango ref. 1262-6200
 Tube allunghi per manico rif. 1262-6200

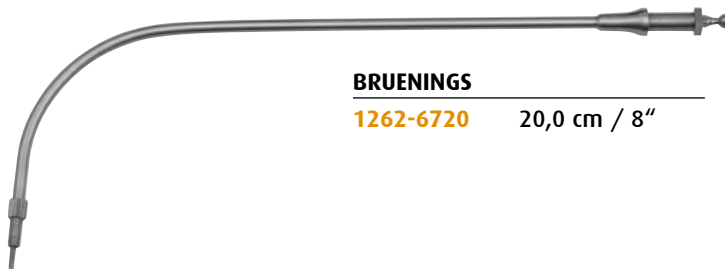

BRUENINGS
1262-6720 20,0 cm / 8"

Verlängerungsrohr gebogen für Handgriff Art.-Nr. 1262-6200
 Interchangeable Tube, curved for handle ref. 1262-6200
 Tubo de extensión, curva para mango ref. 1262-6200
 Tube allunghi, curva per manico rif. 1262-6200

Auswechselbare Zangenaufsätze
Exchangeable Forceps Tips
Pinzas intercambiables
Pinze intercambiabili



FRAENKEL
1262-7001



SEIFFERT
1262-7004



FRAENKEL
1262-7011



SCHEINMANN
1262-7014



SCHEINMANN
1262-7018



BRUENINGS
1262-7009
1262-7010



BRUENINGS
1262-7012
1262-7013



LANGE
1262-7008



KRAUSE
1262-7016
1262-7017



KRAUSE
1262-7015



CORDES
1262-7025
1262-7022
1262-7023
1262-7024



SCHUMACHER
1262-7019



CORDES
1262-7030
1262-7031



CORDES
1262-7021



ROSENBERG
1262-7032

037

Kehlkopfpolypenzange, Deckenhalter
Laryngeal Polypus Forceps, Epiglottis Retractor
Pinza para pólipos laringeos, Depresor para epíglotis
Pinze per polipi laringei, Depressore per epiglottide



1262-5101

nach rechts öffnend
opening to right
side
abriendo hacia la derecha
aprente verso destra



1262-5102

nach links öffnend
opening to left side
abriendo hacia la izquierda
aprente verso sinistra



1262-5103

nach unten öffnend
opening down-ward
abriendo hacia abajo
aprente in basso

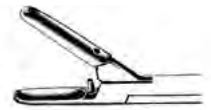

1262-5104

nach oben öffnend
opening up-ward
abriendo hacia arriba
aprente in alto

JURASZ

1262-5101 - 1262-5104

23,0 cm / 9"



REICHERT

1262-4123 24,0 cm / 9 1/2"

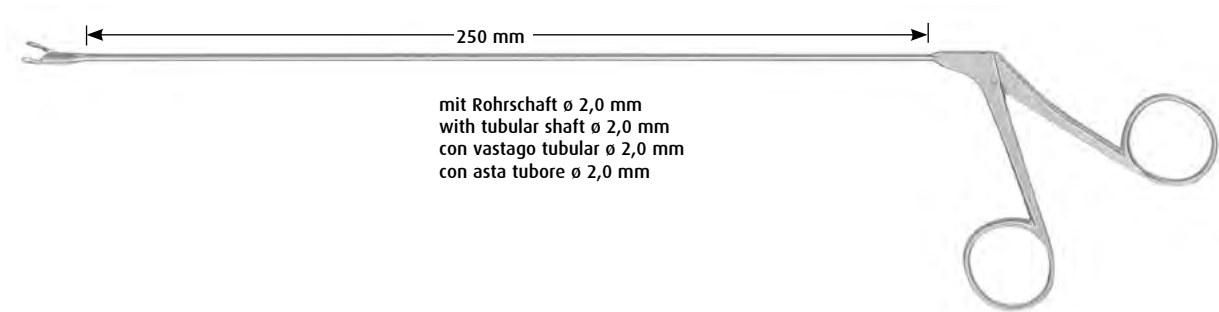

mit Rohrschaft ø 2,0 mm
 with tubular shaft ø 2,0 mm
 con vastago tubular ø 2,0 mm
 con asta tubore ø 2,0 mm

1262-9001 - 1262-9011



gerade
 straight
 recta
 retta

1262-9001

Löffel rund ø 2,5 mm
 round cup ø 2,5 mm
 Cuchara redonda ø 2,5 mm
 Cucchiaino rotondo ø 2,5 mm



links gebogen
 curved left
 curva izquierda
 curva sinistra

1262-9002

Löffel rund ø 2,5 mm
 round cup ø 2,5 mm
 Cuchara redonda ø 2,5 mm
 Cucchiaino rotondo ø 2,5 mm



rechts gebogen
 curved right
 curva derecha
 curva destra

1262-9003

Löffel rund ø 2,5 mm
 round cup ø 2,5 mm
 Cuchara redonda ø 2,5 mm
 Cucchiaino rotondo ø 2,5 mm



aufgebogen
 angled upward
 curva hacia arriba
 curva in alto

1262-9004

Löffel rund ø 2,5 mm
 round cup ø 2,5 mm
 Cuchara redonda ø 2,5 mm
 Cucchiaino rotondo ø 2,5 mm



gerade
 straight
 recta
 retta

1262-9005



links gebogen
 curved left
 curva izquierda
 curva sinistra

1262-9006



rechts gebogen
 curved right
 curva derecha
 curva destra

1262-9007



gerade
 straight
 recta
 retta

1262-9008



links gebogen
 curved left
 curva izquierda
 curva sinistra

1262-9010



rechts gebogen
 curved right
 curva derecha
 curva destra

1262-9009



aufgebogen
 angled upward
 curva hacia arriba
 curva in alto

1262-9011



mit festem Handgriff
with fixed handle
con mango fijo
con manico fisso

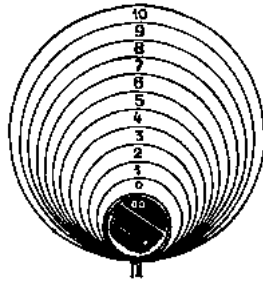

ohne Handgriff
without handle
sin mango
senza manico



MICHEL

25,0 cm / 10"

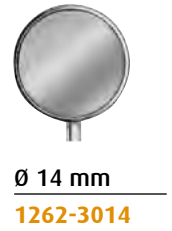
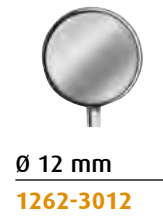

1262-1008	Fig. 00 = 8 mm Ø	1262-0008
1262-1010	Fig. 0 = 10 mm Ø	1262-0010
1262-1012	Fig. 1 = 12 mm Ø	1262-0012
1262-1014	Fig. 2 = 10 mm Ø	1262-0014
1262-1016	Fig. 3 = 16 mm Ø	1262-0016
1262-1018	Fig. 4 = 18 mm Ø	1262-0018
1262-1020	Fig. 5 = 20 mm Ø	1262-0020
1262-1022	Fig. 6 = 22 mm Ø	1262-0022
1262-1024	Fig. 7 = 24 mm Ø	1262-0024
1262-1026	Fig. 8 = 26 mm Ø	1262-0026
1262-1028	Fig. 9 = 28 mm Ø	1262-0028
1262-1030	Fig. 10 = 30 mm Ø	1262-0030



1262-0100 10,0 cm



1262-0200 12,0 cm

Tracheal-Trokare, -Dilatatoren
Tracheotomy Trocars, Tracheal Dilators
Traqueótomos, Dilatadores traqueales
Tracheotomi, Dilatatori

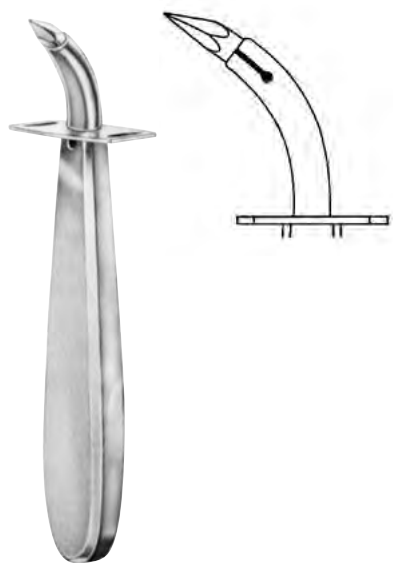

UECKERMANN
 13,0 cm / 5"

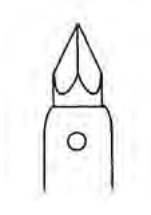

1263-1375 Ø 7,5 mm

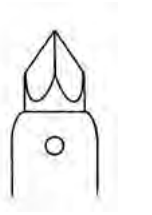

1263-1390 Ø 9 mm



LABORDE
1263-1713 14,0 cm / 5 1/2"



TROUSSEAU
1263-1511 12,0 cm / 4 3/4"
1263-1512 14,0 cm / 5 1/2"



1263-2101



1263-2102

ITERSON

17,0 cm / 6¹/₄"

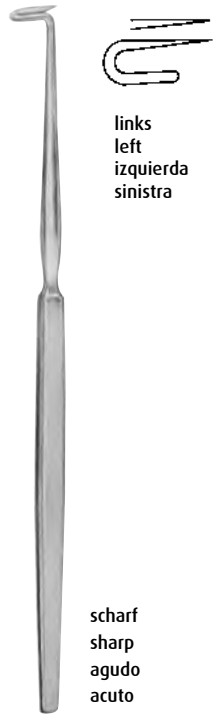

scharf
sharp
agudo
acuto

BOSE

1263-2301

16,0 cm / 6¹/₄"



BOSE

1263-2302

16,0 cm / 6¹/₄"

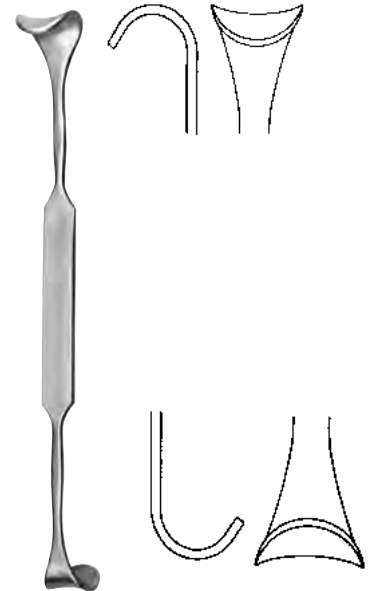

ROSE

1160-6211

13,5 cm / 5"

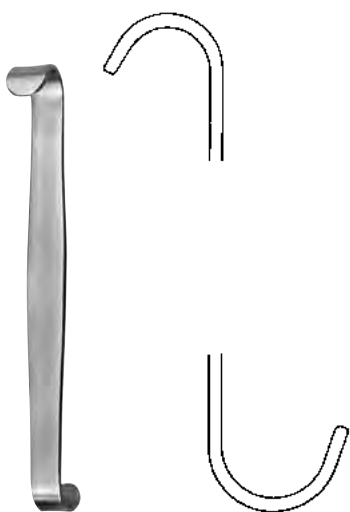

LUER

1263-2711

11,0 cm / 4¹/₂"



JACKSON

1263-2915

15,0 cm / 6"

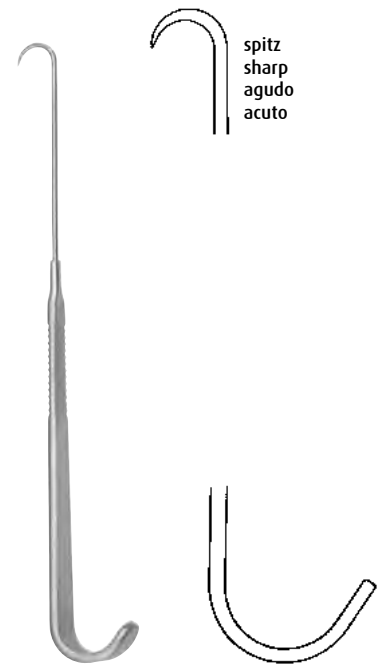

1263-3115

15,0 cm / 6"

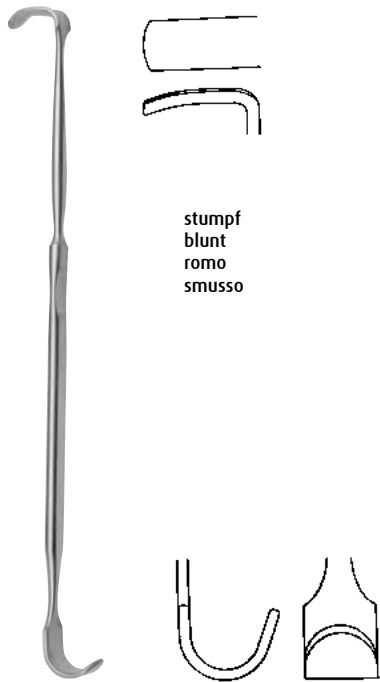

stumpf
 blunt
 romo
 smusso

LUKENS

1263-3317 17,0 cm / 6³/₄"



JACKSON

1263-3517 17,0 cm / 6³/₄"

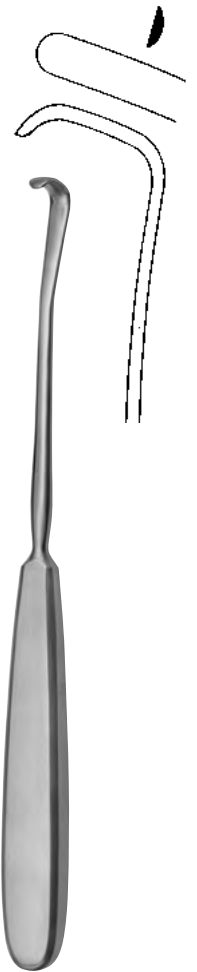

SCHOENBORN

1263-3721 21,0 cm / 8¹/₄"

Material: Neusilber
Material: German Silver
Material: Plata alemana
Materiale: Argentone

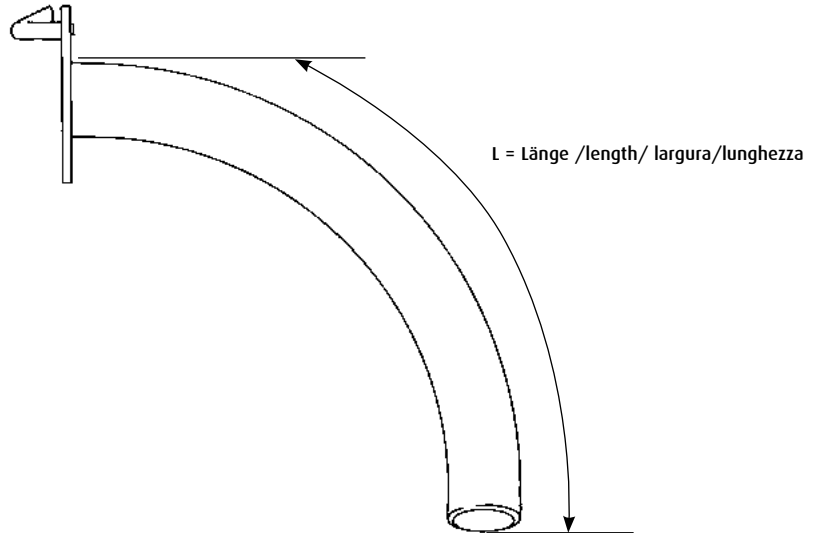

LUER			L
1263-1800	Fig. 0	Ø 4 mm	45 mm
1263-1801	Fig. 1	Ø 5 mm	50 mm
1263-1802	Fig. 2	Ø 6 mm	55 mm
1263-1803	Fig. 3	Ø 7 mm	60 mm
1263-1804	Fig. 4	Ø 8 mm	65 mm
1263-1805	Fig. 5	Ø 9 mm	70 mm
1263-1806	Fig. 6	Ø 10 mm	75 mm
1263-1807	Fig. 7	Ø 11 mm	80 mm
1263-1808	Fig. 8	Ø 12 mm	85 mm
1263-1809	Fig. 9	Ø 13 mm	90 mm



CHEVALIER-JACKSON			L
1263-1900	Fig. 0	Ø 4 mm	45 mm
1263-1901	Fig. 1	Ø 5 mm	50 mm
1263-1902	Fig. 2	Ø 6 mm	55 mm
1263-1903	Fig. 3	Ø 7 mm	60 mm
1263-1904	Fig. 4	Ø 8 mm	65 mm
1263-1905	Fig. 5	Ø 9 mm	70 mm
1263-1906	Fig. 6	Ø 10 mm	75 mm
1263-1907	Fig. 7	Ø 11 mm	80 mm
1263-1908	Fig. 8	Ø 12 mm	85 mm
1263-1909	Fig. 9	Ø 13 mm	90 mm

Tracheotomie-Besteck
Tracheotomy Set
Juego para traqueotomía
Set per tracheotomia

037



200 x 105 x 30 mm

1263-0001

Plastik-Schutztasche für Etui
 Plastic Pouch for case
 Bolsa de plástico para estuche
 Cartoccio di plastica per scatola

TRACHEOTOMIE-BESTECK

1263-0000

komplett im Metall-Etui, mit 2 gelochten Einlagen aus Edelstahl,
 bestehend aus:

1101-0401	1 Skalpellgriff Nr. 4
1101-0401	1 Skalpellgriff Nr. 4
1130-0013	1 anatom. Pinzette gerade, 13,0 cm
1131-0013	2 chir. Pinzetten gerade, 1x2 Zähne, 13,0 cm
1150-1013	2 Pean-Klemmen, 13,0 cm
1106-1013	1 Hohlsonde, 13,0 cm
1162-0707	1 Finsen Wundsperrer stumpf, 7,0 cm
1263-2102	2 Iterson Trachealhäkchen stumpf, 17,0 cm
1263-2301	1 Bose Trachealhäkchen scharf, links, 16,0 cm
1263-2302	1 Bose Trachealhäkchen scharf, rechts, 16,0 cm
1263-1803	1 Luer Trachealkanüle NEUSILBER Fig. 3, Ø 7 mm
1263-1804	1 Luer Trachealkanüle NEUSILBER Fig. 4, Ø 8 mm
1569-1507	1 Reinigungsbürste Ø 12 mm, 26,0 cm
1263-0001	1 Plastik-Schutztasche für Etui

TRACHEOTOMY-SET

1263-0000

in metal case, consisting of:

1101-0401	1 Handle No. 4
1101-0401	1 Handle No. 4
1130-0013	1 Dressing Forcep straight, 13,0 cm
1131-0013	2 Tissue Forceps straight, 1x2 teeth, 13,0 cm
1150-1013	2 Pean Artery Forceps, 13,0 cm
1106-1013	1 Grooved Director, 13,0 cm
1162-0707	1 Finsen Retractor blunt, 7,0 cm
1263-2102	2 Iterson Trachea Retractors blunt, 17,0 cm
1263-2301	1 Bose Trachea Retractor sharp, left hand side, 16,0 cm
1263-2302	1 Bose Trachea Retractor sharp, right hand side, 16,0 cm
1263-1803	1 Luer Trachea tube GERMAN SILVER Fig. 3, Ø 7 mm
1263-1804	1 Luer Trachea tube GERMAN SILVER Fig. 4, Ø 8 mm
1569-1507	1 Cleaning Brush Ø 12 mm, 26,0 cm
1263-0001	1 Plastic Pouch for case

JUEGO PARA TRAQUEOTOMIA

1263-0000

en estuche de metal, compuesto de:

1101-0401	1 Mango de bisturíes No. 4
1101-0401	1 Mango de bisturíes No. 4
1130-0013	1 Pinza de disección recta, 13,0 cm
1131-0013	2 Pinzas de disección rectas, 1x2 dientes, 13,0 cm
1150-1013	2 Pean Pinzas hemostáticas, 13,0 cm
1106-1013	1 Sonda acanalada, 13,0 cm
1162-0707	1 Finsen Separador romo, 7,0 cm
1263-2102	2 Iterson Separadores traqueales romos, 17,0 cm
1263-2301	1 Bose Separador traqueal agudo, lado izquierdo, 16,0 cm
1263-2302	1 Bose Separador traqueal agudo, lado derecho, 16,0 cm
1263-1803	1 Luer Cánula traqueal PLATA ALEMANA fig. 3, Ø 7 mm
1263-1804	1 Luer Cánula traqueal PLATA ALEMANA fig. 4, Ø 8 mm
1569-1507	1 Cepillo de limpieza Ø 12 mm, 26,0 cm
1263-0001	1 Bolsa de plástico para estuche

SET PER TRACHEOTOMIA

1263-0000

in scatola di metallo, contenente:

1101-0401	1 Manico di bisturi No. 4
1101-0401	1 Manico di bisturi No. 4
1130-0013	1 Pinza per dissezione retta, 13,0 cm
1131-0013	2 Pinze per dissezione retta con denti 1x2, 13,0 cm
1150-1013	2 Pean Pinze emostatiche, 13,0cm
1106-1013	1 Sonda scanalata, 13,0 cm
1162-0707	1 Finsen Divaricatore smusso, 7,0 cm
1263-2102	2 Iterson Uncini tracheali smussi, 17,0 cm
1263-2301	1 Bose Uncino tracheale acuto, lato sinistro, 16,0 cm
1263-2302	1 Bose Uncino tracheale acuto, lato destro, 16,0 cm
1263-1803	1 Luer Cannula tracheale ARGENTONE fig. 3, Ø 7 mm
1263-1804	1 Luer Cannula tracheale ARGENTONE fig. 4, Ø 8 mm
1569-1507	1 Spazzolino per pulire Ø 12 mm, 26,0 cm
1263-0001	1 Cartoccio di plastica per scatola

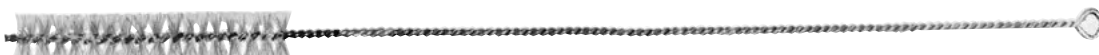

1569-1507 26,0 cm / 10¹/₄" Ø 12 mm

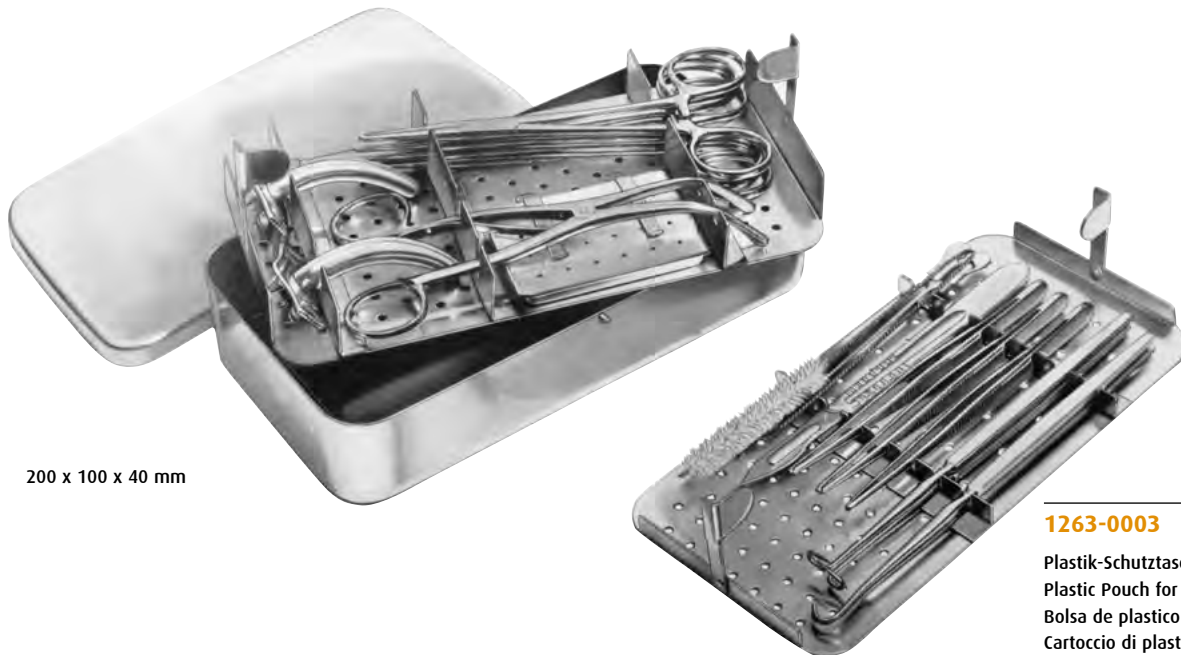

200 x 100 x 40 mm

1263-0003

Plastik-Schutztasche für Etui
 Plastic Pouch for case
 Bolsa de plástico para estuche
 Cartoccio di plastica per scatola

TRACHEOTOMIE-BESTECK

1263-0002

komplett im Metall-Etui, mit 2 gelochten Einlagen aus Edelstahl, bestehend aus:

1101-0401	1 Skalpellgriff Nr. 4
1561-0250	1 Dose für Klagen, gelocht
1130-0013	1 anatom. Pinzette gerade, 13,0 cm
1131-0013	2 chir. Pinzetten gerade, 1x2 Zähne, 13,0 cm
1150-4814	4 Crile Arterienklemmen gerade, 14,0 cm
1106-1013	1 Hohlsonde, 13,0 cm
1263-1512	1 Trousseau Trachealdilatator, 14,0 cm
1263-2102	2 Iterson Trachealhäkchen stumpf, 17,0 cm
1263-2301	1 Bose Trachealhäkchen scharf, links, 16,0 cm
1263-2302	1 Bose Trachealhäkchen scharf, rechts, 16,0 cm
1263-1802	1 Luer Trachealkanüle NEUSILBER Fig. 2, Ø 6 mm
1263-1804	1 Luer Trachealkanüle NEUSILBER Fig. 4, Ø 8 mm
1569-1507	1 Reinigungsbürste Ø 12 mm, 26,0 cm
1263-0003	1 Plastik-Schutztasche für Etui

JUEGO PARA TRAQUEOTOMIA

1263-0002

Completo en estuche de Metal, con 2 bandejas perforadas de acero, compuesto de:

1101-0401	1 Mango de bisturios No. 4
1561-0250	1 Cajita para hojas de bisturios, perforada
1130-0013	1 Pinza de disección recta, 13,0 cm
1131-0013	2 Pinzas de disección rectas, 1x2 dientes, 13,0 cm
1150-4814	4 Crile Pinzas hemostáticas rectas, 14,0 cm
1106-1013	1 Sonda acanalada, 13,0 cm
1263-1512	1 Trousseau Dilatador traqueal, 14,0 cm
1263-2102	2 Iterson Separadores traqueales romos, 17,0 cm
1263-2301	1 Bose Separador traqueal agudo, lado izquierdo, 16,0 cm
1263-2302	1 Bose Separador traqueal agudo, lado derecho, 16,0 cm
1263-1802	1 Luer Cánula traqueal PLATA ALEMANA fig. 2, Ø 6 mm
1263-1804	1 Luer Cánula traqueal PLATA ALEMANA fig. 4, Ø 8 mm
1569-1507	1 Cepillo de limpieza Ø 12 mm, 26,0 cm
1263-0003	1 Bolsa de plástico para estuche

TRACHEOTOMY SET

1263-0002

complete in metal-case, with 2 perforated trays of stainless steel, consisting of:

1101-0401	1 Scalpel Handle No. 4
1561-0250	1 Small case for above Scalpel blades, perforated
1130-0013	1 Dressing Forcep straight, 13,0 cm
1131-0013	2 Tissue Forceps straight, 1x2 teeth, 13,0 cm
1150-4814	4 Crile Artery Forceps straight, 14,0 cm
1106-1013	1 Grooved Director, 13,0 cm
1263-1512	1 Trousseau Trachea Dilator, 14,0 cm
1263-2102	2 Iterson Trachea Retractors blunt, 17,0 cm
1263-2301	1 Bose Trachea Retractor sharp, left hand side, 16,0 cm
1263-2302	1 Bose Trachea Retractor sharp, right hand side, 16,0 cm
1263-1802	1 Luer Trachea tube GERMAN SILVER Fig. 2, Ø 6 mm
1263-1804	1 Luer Trachea tube GERMAN SILVER Fig. 4, Ø 8 mm
1569-1507	1 Cleaning Brush Ø 12 mm, 26,0 cm
1263-0003	1 Plastic Pouch for case

SET PER TRAQUEOTOMIA

1263-0002

completo in scatola di metallo, con 2 supporti perforati di acciaio; composto de:

1101-0401	1 Manico di bisturi No. 4
1561-0250	1 Scatoletta per lame
1130-0013	1 Pinza per dissezione retta, 13,0 cm
1131-0013	2 Pinze per dissezione rette con denti 1x2, 13,0 cm
1150-4814	4 Crile Pinze emostatiche rette, 14,0 cm
1106-1013	1 Sonda scanalata, 13,0 cm
1263-1512	1 Trousseau Dilatatore per tracheotomia, 14,0 cm
1263-2102	2 Iterson Uncini tracheali smussi, 17,0 cm
1263-2301	1 Bose Uncino tracheale acuto, lato sinistro, 16,0 cm
1263-2302	1 Bose Uncino tracheale acuto, lato destro, 16,0 cm
1263-1802	1 Luer Cannula tracheale ARGENTONE fig. 2, Ø 6 mm
1263-1804	1 Luer Cannula tracheale ARGENTONE fig. 4, Ø 8 mm
1569-1507	1 Spazzollino per pulire Ø 12 mm, 26,0 cm
1263-0003	1 Cartoccio di plastica per scatola

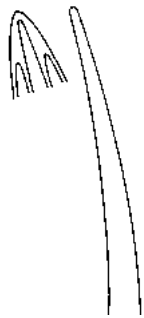

1263-3901

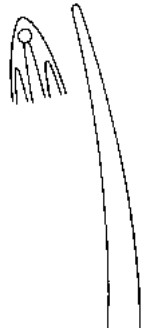

1263-3902

KOCHER

1263-3901 - 1263-3902

15,0 cm / 6"

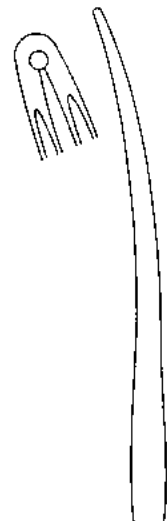

KOCHER

1263-3903

18,0 cm / 7"

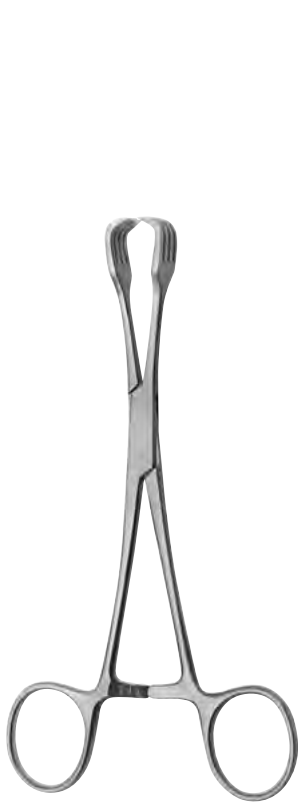

3x3



1263-4015

3x3



1263-4020

LAHEY

1263-4015 15,0 cm / 6"
 1263-4020 20,0 cm / 8"

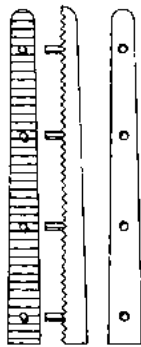

MASTIN

1263-4117 17,0 cm / 7"

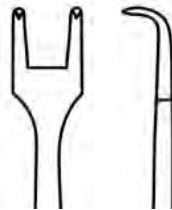
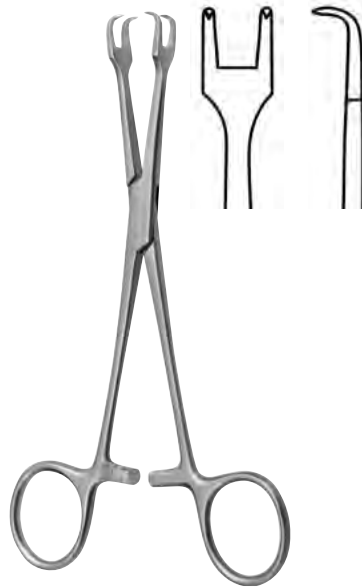

LAHEY

1352-2801 15,0 cm / 6"



BRAUN

1263-4215 15,0 cm / 6"

046

**Dermatologie
Dermatology
Dermatología
Dermatologia**





Lupusschaber
 Lupus Scraper
 Rascador para lupus
 Raschiatoio per lupus

VIDAL

1104-1114 14,0 cm / 5 1/2"



3,0 mm

4,0 mm



Fig.1

Fig.2

1104-1203

1104-1204

5,0 mm

6,0 mm



Fig.3

Fig.4

1104-1205

1104-1206

FOX

1104-1203 - 1104-1206 14,0 cm / 5 1/2"



Fig.1

1104-1401



Fig.2

1104-1402



Fig.3

1104-1403



Fig.4

1104-1404



Fig.5

1104-1405



Fig.6

1104-1406

WOLFF

1104-1401 - 1104-1406 14,0 cm / 5 1/2"



scharf
 sharp
 agudo
 acuto

KILNER

1161-5016 15,0 cm / 6"

Hauthäkchen, Face-Lift-Haken, Hauttrephinen
Skin Hooklets, Dermal Punches
Ganchitos para piel, Trépanos para piel
Uncini cutanei, Trefine cutanee

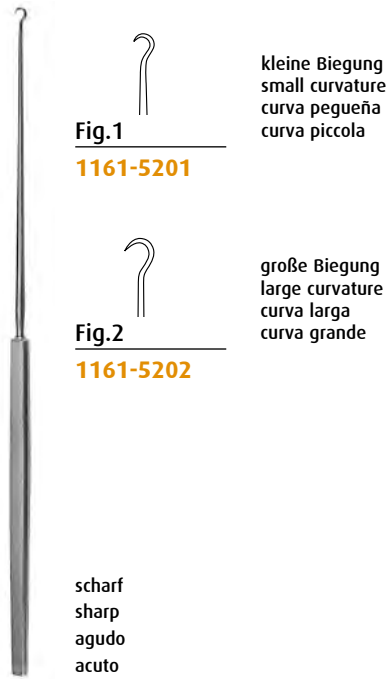

GILLIES

1161-5201- 1161-5202

18,0 cm / 7"

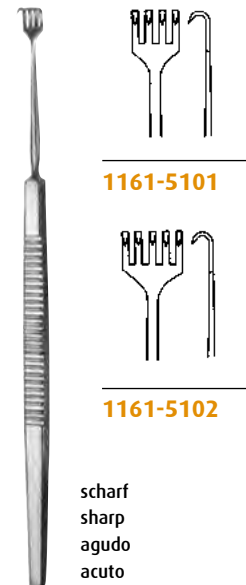

KAYE

1161-5101 - 1161-5102

13,0 cm / 5"

Trephinensatz komplett auf Platte mit Griff
und 6 auswechselbaren Trephinen

Punch Set complete on plate with handle and
6 exchangeable Punches

Juego de trepanos para piel completo en chapa
con mango y 6 trépanos cambiables

Serie di trefine cutanee completo in lastra con
manico e 6 trefine cambiabile

1104-2201

Griff allein
Handle only
Mango suelto
Manico solo

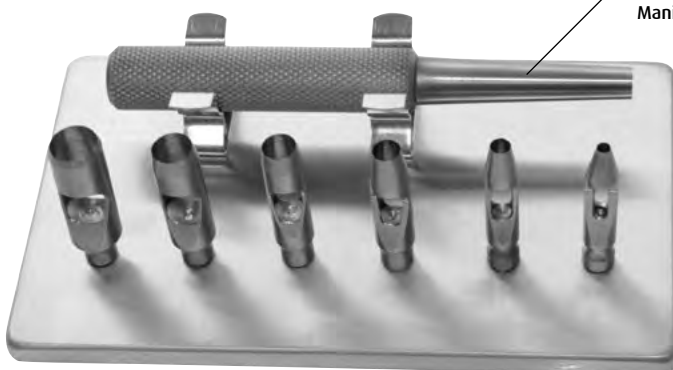

KEYES

1104-2200

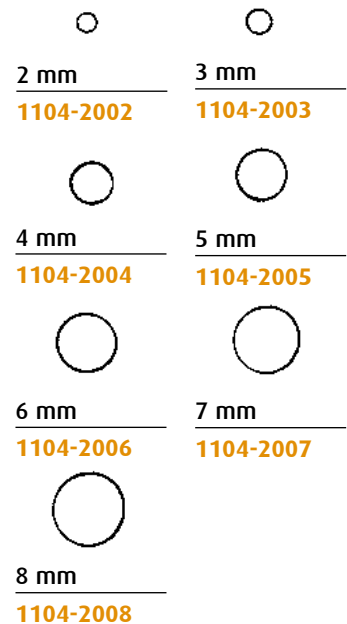
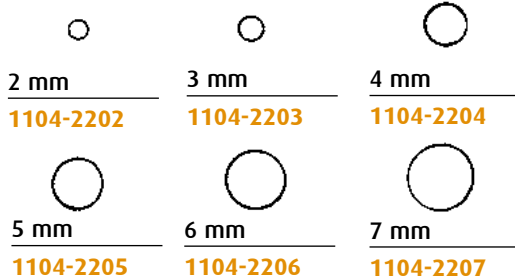

KEYES

1104-2002 - 1104-2008

12,0 cm / 4³/₄"

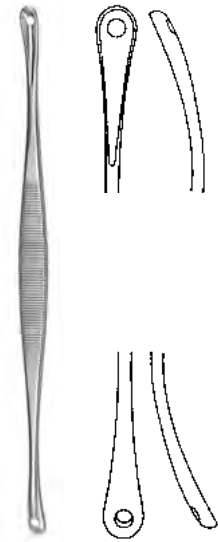

UNNA
1104-3114 14,0 cm / 5 1/2"



UNNA
1104-3314 14,0 cm / 5 1/2"



SAALFELD
1104-3511 10,0 cm / 4"

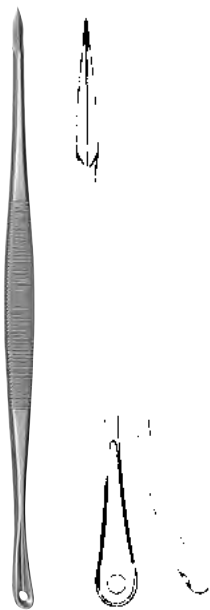

SAALFELD
1104-3714 14,0 cm / 5 1/2"

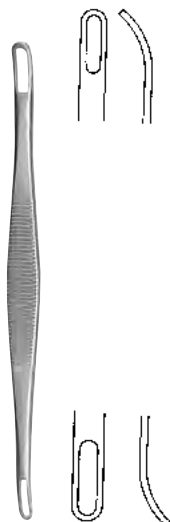

SCHAMBERG
1104-3909 10,0 cm / 4"

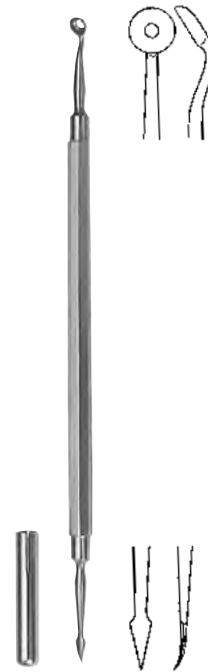

KATSCH
1104-4114 14,0 cm / 5 1/2"

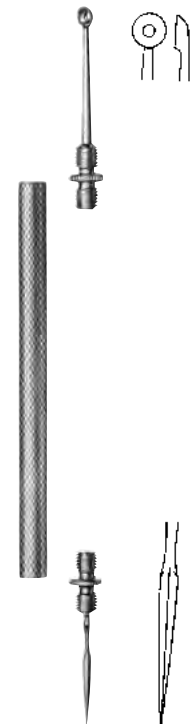

UNNA-VIDAL
1104-4611 11,5 cm / 4 1/2"

Nagelscheren
Nail scissors
Tijeras para uñas
Forbici per unghie



1500-4001 11,0 cm / 4¹/₃"

Feile alleine
 file only
 lima suelta
 lima sola

1500-4002 50,0 cm / 19¹/₂"

Kette alleine
 chain only
 cadena suelta
 catena sola

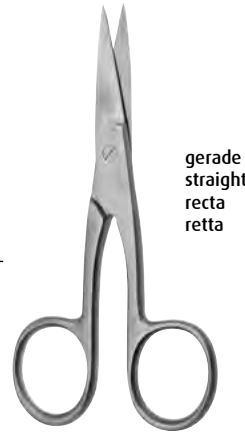

gerade
 straight
 recta
 retta



gebogen
 curved
 curva
 curva

1500-0610 10,0 cm / 4"

1500-0709 9,0 cm / 3¹/₂"
1500-0710 10,0 cm / 4"

1500-4000

Schwesterngarnitur, bestehend aus Nagelschere (gebogen) und Nagelfeile, mit Kette

Hospital Nurse Set, consisting of nail scissors (curved) and nail file, with chain

Juego de manicura para enfermeras, compuesto de tijeras (curva) y lima para uñas, con cadena

Set di manicura per infermieri, composto di forbici (curva) e lima per unghie, con catena

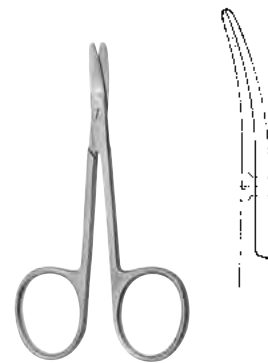

1500-0508 8,5 cm / 3¹/₂"



1500-1409

1500-1509

1550-0910

1500-1409 - 1500-1509
1550-0910

9,5 cm / 3³/₄"
 10,5 cm / 4¹/₄"

046

Nagelzangen
Nail Nippers
Pinzas para cortar uñas
Tronchesine per unghie

 **simex**
Medizintechnik GmbH



1500-2614 14,0 cm / 5¹/₂"



1500-2714 14,0 cm / 5¹/₂"

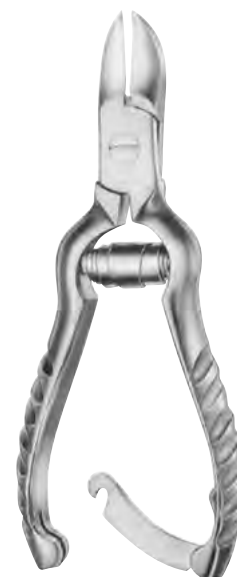

TURNBULL

1500-2411 11,0 cm / 4³/₈"
1500-2413 13,0 cm / 5"



1500-2514 13,0 cm / 5"



1500-2212 12,0 cm / 4³/₄"

Nageleckenzangen, Nagelhautzangen, Nagelfeilen
Nail Nippers, Cuticle Nippers, Nail Files
Pinzas para cortar uñas, Pinzas cuticulares, Limas para uñas
Tronchesine per unghie, Tronchesine per pelle, Lime per unghi

046



gerade Schneiden
 straight cutting edges
 hojas cortantes rectas
 parte tagliente diritta

1500-2311 11,0 cm / 4¹/₂"
1500-2311 13,0 cm / 5"
1500-2315 15,0 cm / 6"



1500-2111 11,0 cm / 4¹/₂"

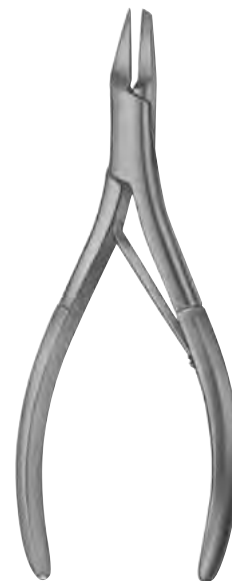

1500-2135 13,5 cm / 5¹/₄"

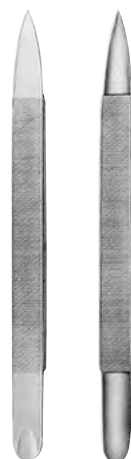

1500-3212 12,0 cm / 4³/₄"



1500-4001 11,0 cm / 4¹/₂"



mit Saphirbelag
 with sapphire coating
 con recubrimiento de zafiro
 con rivestimento in zaffiro

1500-3216 16,0 cm / 6¹/₄"

085

Sterilisation, Hygiene, Aufbewahrung
Sterilisation, Hygiene, Storage
Esterilización, Higiene, Almacenaje
Sterillizzazione, Magazzinaggio



085

Handwaschbürste, Bürstenspender
Hand and nail brush, brush dispenser
Cepillo para uñas, dispensadores de cepillos
Spazzola per unghie, Distributore per spazzole

mehr als 400 x autoclavierbar
more than 400 x autoclavable
más que 400 x autoclavable
sterilizzabile più di 400 volte in autoclave



ASEPTIC

1569-1101

Kunststoff
plastic
plástico
plastico

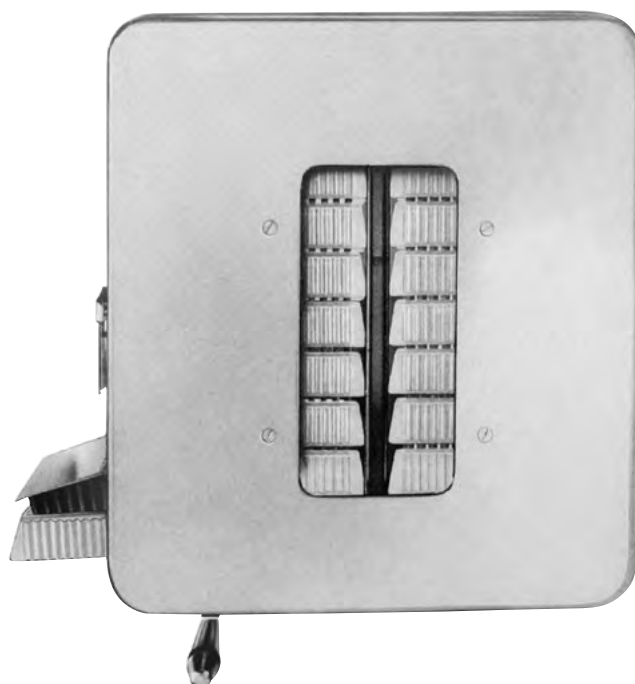

mit Aufhängevorrichtung
with suspension
con suspensión
con sospensione

MARTIN

1569-1102

für 20 Bürsten (ohne Bürsten)
for 20 brushes (without brushes)
para 20 cepillos (sin cepillos)
per 20 spazzole (senza spazzole)



1569-1103

Ersatzglas, Kunststoff
Spare Glass, plastic
Vidrio de repuesto, plástico
Vetro di sostituzione, plastico



1569-1104

Aufhängevorrichtung, für großen Bürstenspender
suspension, for large brush dispenser
suspensión, para dispensador de cepillos grande
Suspensione, per distributore di spazzole grande



1569-1105

Aufhängevorrichtung, für Bürstenabwurfbehälter
 Suspension, for brush collecting box
 Suspensión, para recipiente de descarga para cepillos
 Suspensione, per contenitore per spazzole usate



1569-1106 200 x 180 x 135 mm

mit Aufhängevorrichtung
 with suspension
 con suspensión
 con sospensione

1569-1107 200 x 180 x 135 mm

ohne Aufhängevorrichtung
 without suspension
 sin suspensión
 senza sospensione

Kappenzangen
Dressing Forceps in jar with cap
Pinza en tarro con tapa
Pinza-coperchio

085



1562-2025 25,0 cm / 9³/₄"

Standgefäß 20,5 cm hoch
mit 25 cm langer Kornzange

jar 20,5 cm high
with 25 cm long dressing forceps

tarro 20,5 de altura
con pinza de vendaje de 25 cm

contenitore 20,5 cm di altezza
con pinza per medicatura die 25 cm di lunghezza



1562-2032 32,0 cm / 12¹/₂"

Standgefäß 25,5 cm hoch
mit 32 cm langer Kornzange

jar 25,5 cm high
with 32 cm long dressing forceps

tarro 25,5 de altura
con pinza de vendaje de 32 cm

contenitore 25,5 cm di altezza
con pinza per medicatura die 32 cm di lunghezza

**CHEATTLE**

1500-6128 27,0 cm / 10¹/₂"



1500-6420 20,0 cm / 8"
1500-6430 30,0 cm / 11³/₄"

**ROGGE**

1500-6623 23,5 cm / 9¹/₄"

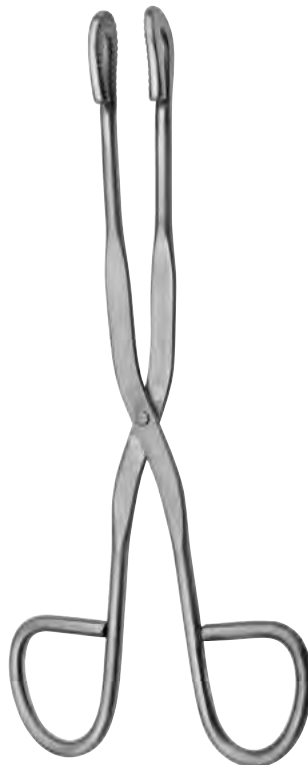
**UNIVERSAL**

1500-6220 20,0 cm / 8"
1500-6230 28,0 cm / 11"

**UNIVERSAL**

1500-6320 20,0 cm / 8"
1500-6330 28,0 cm / 11"

Sterilisierklammern, Schlauchklemmen, Quetschhähne
Safety Pins, Pinchcocks, Tubing clamps
Imperdibles para esterilización, Cierra-tubos
Spilli di sicurezza per sterilizzazione, Morsetti per tubi

085



BUNT

1158-5112 12,0 cm / 4³/₄"



MAYO

1158-5113 14,0 cm / 5¹/₂"



HOFFMANN

1158-6110 13 mm
1158-6111 17 mm
1158-6112 20 mm
1158-6113 25 mm
1158-6114 30 mm
1158-6115 40 mm



MOHR

1158-6116 40 mm
1158-6117 50 mm
1158-6118 60 mm
1158-6119 70 mm
1158-6120 80 mm



DEPONETTE

1159-8035 245 x 135 x 35 mm

Boden perforiert, mit Textilfilter (15631-0401)
perforated bottom, with textile filter (15631-0401)
fondo perforado, con filtro de tejido (15631-0401)
fondo perforato, con filtri tessili (15631-0401)



DEPONETTE

1159-8050 245 x 135 x 50 mm

Boden perforiert, mit Textilfilter (15631-0401)
perforated bottom, with textile filter (15631-0401)
fondo perforado, con filtro de tejido (15631-0401)
fondo perforato, con filtri tessili (15631-0401)

Deckel und Boden perforiert, mit Scharnierdeckel
 perforated lid and bottom, with hinged lid
 tapa y fondo perforado, con tapa de bisagra
 coperchio e fondo perforati, con coperchio a cerniera



Behälter Cases Cajas Scatole	Abmessung Sizes Tamaños Dimensione	Ersatz-Textilfilter, Packung mit 5 Paar Spare Textile Filters, package of 5 pairs Filtros de tejido de recambio, paquete con 5 pares Filtri di tessuti di ricambio, pacchetto con 5 paia
1563-0001	230 x 130 x 50 mm	1563-0401
1563-0002	260 x 150 x 50 mm	1563-0402
1563-0003	275 x 235 x 50 mm	1563-0403
1563-0004	300 x 200 x 50 mm	1563-0404
1563-0005	325 x 275 x 50 mm	1563-0405
1563-0006	420 x 175 x 50 mm	1563-0406
1563-0201	230 x 130 x 75 mm	1563-0401
1563-0202	260 x 150 x 75 mm	1563-0402
1563-0204	300 x 200 x 75 mm	1563-0404
1563-0205	325 x 275 x 75 mm	1563-0405
1563-0206	420 x 175 x 75 mm	1563-0406

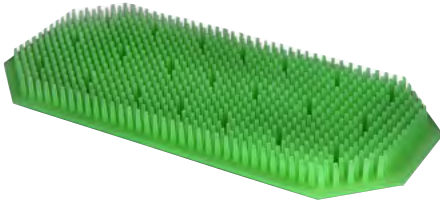

1554-9500 270 x 125 mm

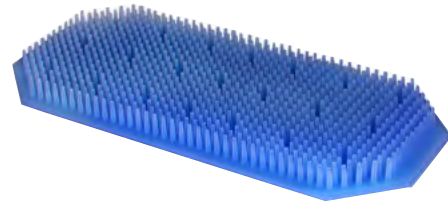

1554-9500 B 270 x 125 mm

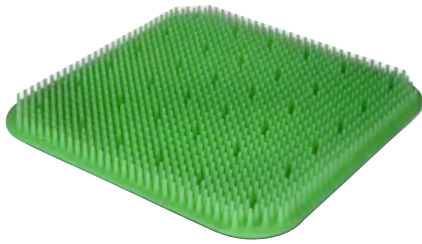

1558-5100 245 x 245 mm



1558-5100 B 245 x 245 mm

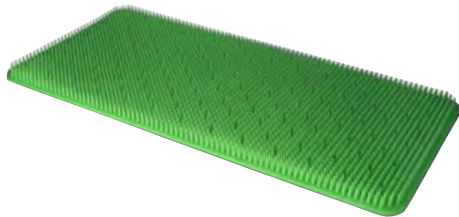

1558-5200 220 x 230 mm
1558-5300 380 x 230 mm
1558-5400 440 x 230 mm
1558-5500 520 x 230 mm

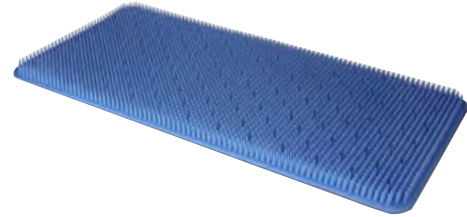

1558-5200 B 220 x 230 mm
1558-5300 B 380 x 230 mm
1558-5400 B 440 x 230 mm
1558-5500 B 520 x 230 mm

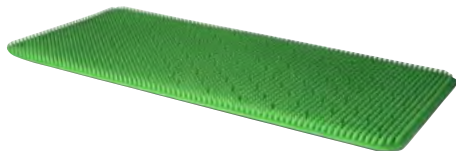

1558-5515 300 x 150 mm
1558-5530 300 x 300 mm

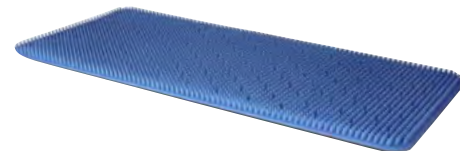

1558-5515 B 300 x 150 mm
1558-5530 B 300 x 300 mm



1558-5630 B 545 x 255 mm

Die Matte kann auf das gewünschte Maß zugeschnitten werden
 The mat can be cut to the desired dimensions
 La alfombra se puede cortar hasta la medida deseada
 La stuoia può essere tagliato a misura desiderata

Rückseite
 Back side
 Dorso
 Retro



Drahtgeflecht
wire mesh
malla de alambre
griglia in metallo

1501-2030	535 x 250 x 30 mm
1501-2050	535 x 250 x 50 mm
1501-2070	535 x 250 x 70 mm
1501-2100	535 x 250 x 100 mm

Drahtgeflecht
wire mesh
malla de alambre
griglia in metallo

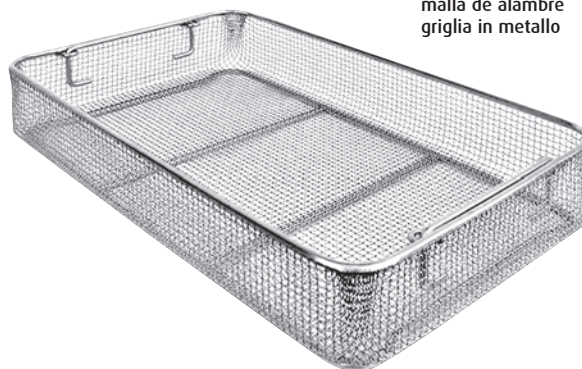

Drahtgeflecht
wire mesh
malla de alambre
griglia in metallo

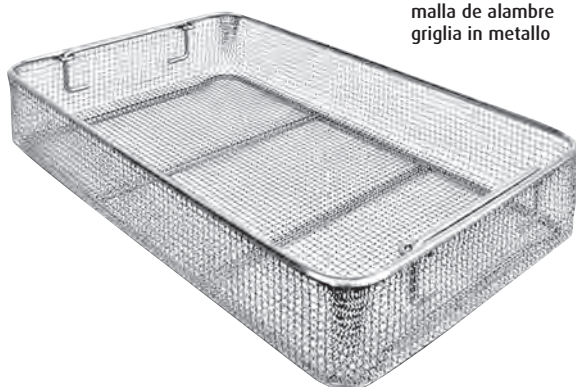

1501-3030	482 x 250 x 30 mm
1501-3050	482 x 250 x 50 mm
1501-3070	482 x 250 x 70 mm
1501-3100	482 x 250 x 100 mm

Drahtgeflecht
wire mesh
malla de alambre
griglia in metallo

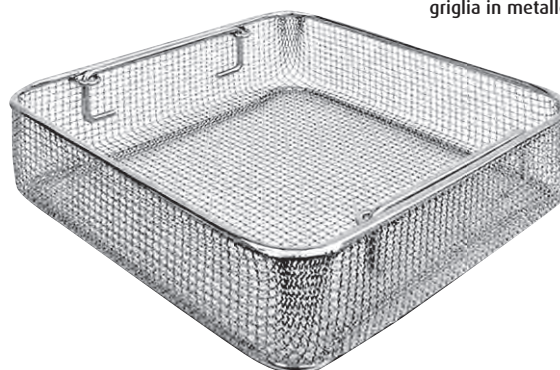

1502-2030	400 x 250 x 30 mm
1502-2050	400 x 250 x 50 mm
1502-2070	400 x 250 x 70 mm
1502-2100	400 x 250 x 100 mm

1503-2030	250 x 240 x 30 mm
1503-2050	250 x 240 x 50 mm
1503-2070	250 x 240 x 70 mm
1503-2100	250 x 240 x 100 mm

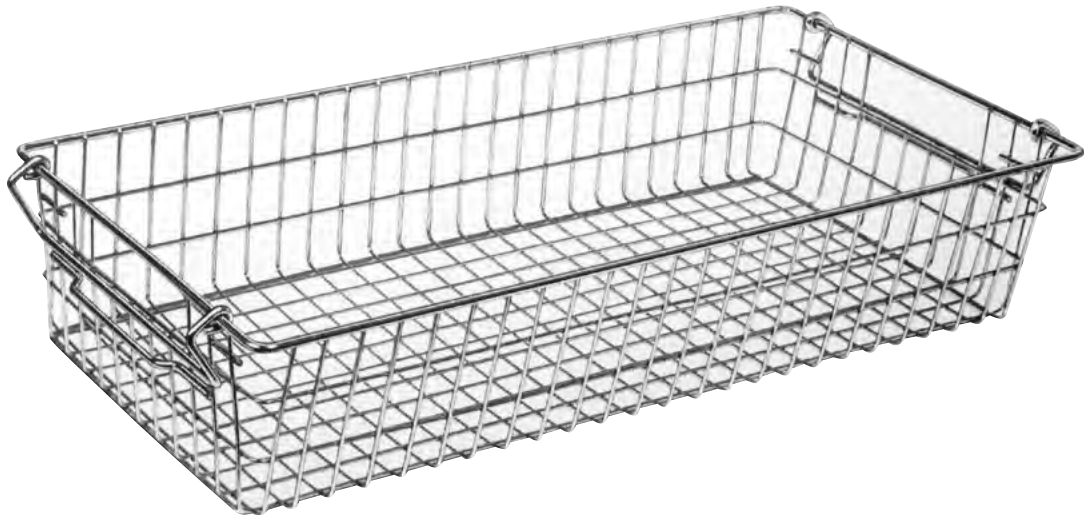

1554-0013 600 x 300 x 130 mm

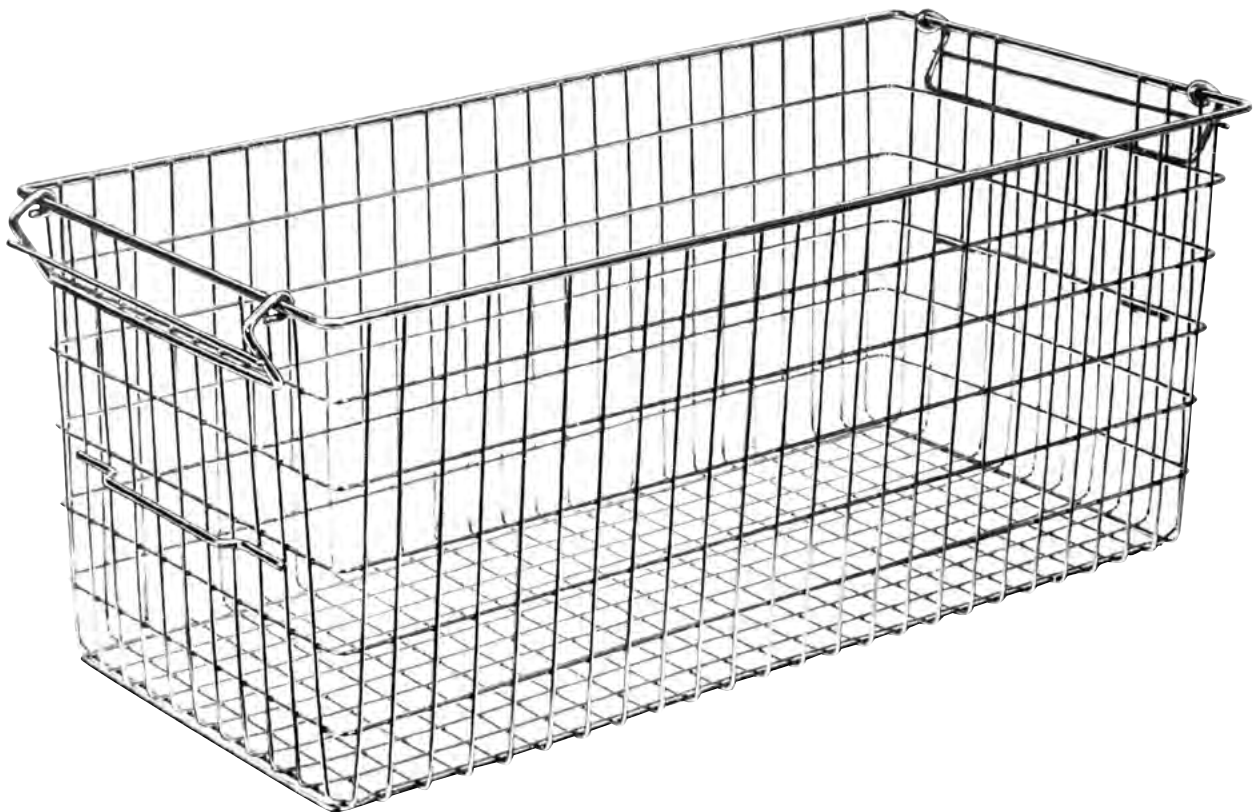

1556-0026 600 x 300 x 260 mm

Metallschalen, Rundschalen, Flachschen, Messbecher
Stainless Steel Bowls, Round Dishes, Flat Dishes, Measurers
Cubetas de acero inoxidable, Cubetas redondas, Cubetas planas, Vaso-medidas
Scodelle di acciaio inossidabile, Scodelle rotonde, Scodelle piatte, Bicchieri graduati

085

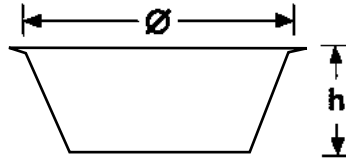

Ø x h

1511-0304	Ø 40 x 19 mm	0,05 l
1511-0306	Ø 61 x 30 mm	0,07 l
1511-0308	Ø 80 x 40 mm	0,14 l
1511-0311	Ø 116 x 50 mm	0,35 l
1511-0312	Ø 128 x 55 mm	0,45 l
1511-0314	Ø 147 x 65 mm	0,70 l
1511-0315	Ø 167 x 75 mm	1,10 l
1511-0316	Ø 187 x 85 mm	1,60 l



Ø x h

1511-0511	Ø 116 x 35 mm	0,30 l
1511-0512	Ø 128 x 38 mm	0,40 l
1511-0514	Ø 147 x 40 mm	0,50 l
1511-0515	Ø 157 x 45 mm	0,75 l
1511-0518	Ø 187 x 45 mm	1,00 l



Ø x h

1511-1315	Ø 110 x 28 mm	0,15 l
------------------	---------------	--------



innen graduiert
 graduated inside
 graduado en el interior
 graduato all'interno

Ø x h

1511-1000	100 ccm	0,1 l
------------------	---------	-------



innen graduiert
 graduated inside
 graduado en el interior
 graduato all'interno

1511-0903	0,25 l
1511-0904	0,50 l
1511-0905	1,00 l
1511-0906	2,00 l

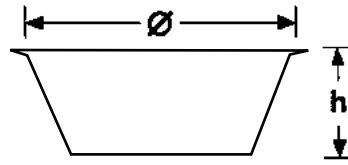

	Ø x h	
1511-0116	Ø 150 x 74 mm	0,75 l
1511-0117	Ø 160 x 65 mm	1,00 l
1511-0122	Ø 220 x 70 mm	2,00 l
1511-0124	Ø 240 x 95 mm	3,00 l
1511-0127	Ø 260 x 130 mm	4,50 l
1511-0131	Ø 300 x 105 mm	6,00 l
1511-0134	Ø 320 x 140 mm	8,50 l
1511-0138	Ø 380 x 125 mm	11,00 l
1511-0141	Ø 400 x 150 mm	14,00 l



	Ø x h	
1511-0520	Ø 110 x 27 mm	0,20 l
1511-0530	Ø 110 x 40 mm	0,30 l



	Ø x h	
1511-0536	Ø 330 x 90 mm	6,00 l
1511-0538	Ø 330 x 115 mm	8,00 l

Mehrzweckschalen, Instrumententabletts
Universal Trays, Instrument Trays
Bandejas universales, Bandejas para instrumentos
Bacinelle universali, Bacinelle per strumenti

085

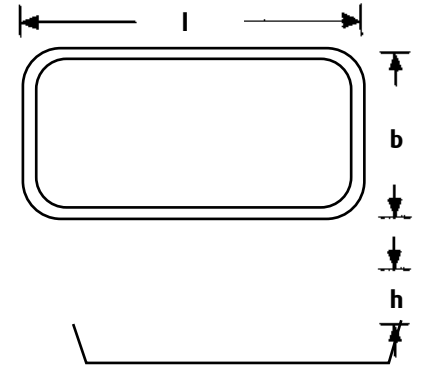

l x b x h

1511-2023	230 x 155 x 30 mm
1511-2030	300 x 175 x 30 mm
1511-2031	300 x 175 x 40 mm
1511-2035	350 x 240 x 36 mm
1511-2040	400 x 300 x 50 mm



l x b x h

1511-3001	210 x 160 x 10 mm
1511-3002	240 x 180 x 10 mm
1511-3003	310 x 150 x 10 mm
1511-3004	310 x 210 x 10 mm
1511-3005	350 x 240 x 10 mm
1511-3006	400 x 270 x 20 mm
1511-3007	420 x 280 x 10 mm

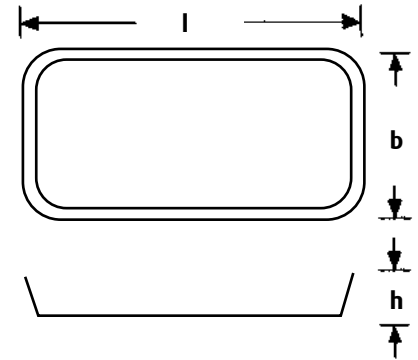

$l \times b \times h$

1511-3123 235 x 190 x 40 mm

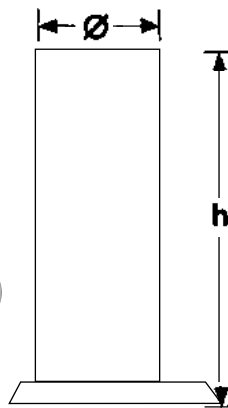

Deckel allein, geschlossen
 Lid only, closed
 Tapa suelta, cerrada
 Coperchio solo, chiuso

1511-0710 Ø 50 mm
1511-0711 Ø 75 mm
1511-0712 Ø 100 mm



Deckel allein, mit dreieckiger Aussparung
 Lid only, with triangular opening
 Tapa suelta, con abertura triangular
 Coperchio solo, con apertura triangolare

1511-0713 Ø 50 mm
1511-0714 Ø 75 mm
1511-0715 Ø 100 mm

$\varnothing \times h$

1511-0701 Ø 30 x 90 mm
1511-0702 Ø 50 x 100 mm
1511-0703 Ø 50 x 130 mm
1511-0704 Ø 50 x 175 mm
1511-0705 Ø 75 x 100 mm
1511-0706 Ø 75 x 130 mm
1511-0707 Ø 75 x 175 mm
1511-0708 Ø 100 x 175 mm
1511-0709 Ø 100 x 200 mm



mit Knopfdeckel
 lid with knob
 tapa con botòn
 con coperchio a bottone



Deckel ohne Knopf
 lid without knob
 tapa sin botòn
 coperchio senza bottone

	I x b x h
1511-4023	165 x 85 x 35 mm
1511-4024	200 x 100 x 35mm
1511-4025	200 x 100 x 50 mm
1511-4026	230 x 130 x 50 mm
1511-4027	260 x 150 x 50 mm
1511-4028	270 x 235 x 50 mm
1511-4029	300 x 200 x 50 mm
1511-4030	325 x 275 x 50 mm

	I x b x h
1511-4102	165 x 85 x 35 mm
1511-4104	200 x 100 x 35 mm
1511-4105	200 x 100 x 50 mm
1511-4106	230 x 130 x 50 mm
1511-4107	260 x 150 x 50 mm
1511-4108	270 x 235 x 50 mm
1511-4109	300 x 200 x 50 mm
1511-4110	325 x 275 x 50 mm

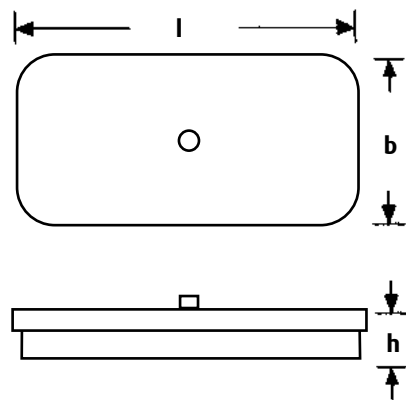



mit Knopfdeckel
 lid with knob
 tapa con botón
 con coperchio a bottone

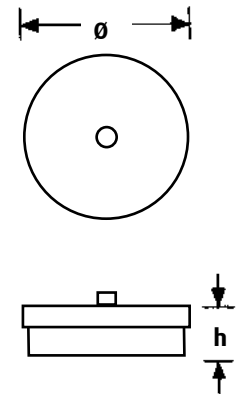

	Ø x h
1511-1101	Ø 75 x 60 mm
1511-1102	Ø 75 x 75 mm
1511-1103	Ø 100 x 60 mm
1511-1104	Ø 100 x 100 mm
1511-1105	Ø 125 x 80 mm
1511-1106	Ø 125 x 125 mm
1511-1107	Ø 150 x 150 mm



1511-0901 25 ccm

innen graduiert
 graduated inside
 graduado en el interior
 graduato all'interno



1511-0902 50 ccm

innen graduiert
 graduated inside
 graduado en el interior
 graduato all'interno



1511-0900 20 ccm

Medizinlöffel
 Medicine Spoon
 Cuchara medicinal
 Cucchiaino per medicina

innen graduiert
 graduated inside
 graduada en el interior
 graduato all'interno



Ø x h
1511-0975 Ø 75 x 12 mm

Tablettenschale
 Tablet Tray
 Bandejita para tabletas
 Bacinella per compresse



1511-0990 Ø 90 x 90 mm

Mundbecher
 Metal cup
 Vaso metalico
 Biocchiere metallico



1511-0980 Ø 75 x 80 mm

Sputumbecher
 Sputum cup
 Escupidera
 Sputacciera



METHOT

1511-0950 Ø 50 x 75 mm

mit Deckel
 with lid
 con tapa
 con coperchio



METHOT

1511-0910 Ø 50 x 75 mm

ohne Deckel
 without lid
 sin tapa
 senza coperchio



METHOT

1511-0911 Ø 50 x 75 mm

ohne Deckel
 without lid
 sin tapa
 senza coperchio



Kunststoff
 plastic
 plastico
 materiale plastico

METHOT

1511-0912 Ø 45 x 55 mm

Einsatz
 Insert
 Inserto
 Inserto

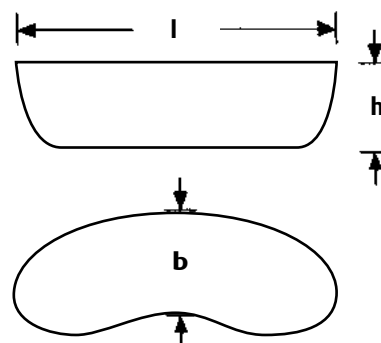

l x b x h

1511-0017	170 x 100 x 35 mm
1511-0025	250 x 140 x 40 mm
1511-0027	275 x 150 x 45 mm



1151-2000	Ø 235 mm
1151-2001	Ø 310 mm

Knopfdeckel, allein
Lid knob, only
Tapa con boton, suelta
Coperchio a bottone, solo

1151-2002	Ø 235 mm
1151-2003	Ø 310 mm

Dreieckschalen, Plazentabecken
Triangular Basins, Placenta Pan
Cubetas triangulares, cubeta para placenta
Bacinelle triangolari, Bacinella per placenta

085



1511-2006

innen graduert bis 600 ml, mit Griff
graduated inside up to 600 ml, with handle
graduado en el interior hasta 600 ml, con mango
graduato all'interno fino a 600 ml, con manico



1511-2008

innen graduert bis 600 ml, ohne Griff
graduated inside up to 600 ml, without handle
graduado en el interior hasta 600 ml, sin mango
graduato all'interno fino a 600 ml, senza manico



AQUAJET

1569-0020

komplett mit 9 Aufsätzen 1569-0001bis 1569-0009,
 1 m Druckschlauch, Haken und Schelle

complete, with 9 tips 1569-0001to 1569-0009,
 1 m pressure tube, strap and suspension hook

completa, con 9 toberas 1569-0001a 1569-0009,
 1 m tubo de presión, abrazadera y gancho de suspension

completa, con 9 raccordi 1569-0001fino a 1569-0009,
 1 m tubo ad alta pressione, graffa e gancio di sospensione

Aufsätze siehe nächste Seite
 tips see next page
 toberas véase siguiente pagina
 raccordi vedi seguente pagina

AQUAJET

1569-0021

ohne Aufsätze
 without tips
 sin toberas
 senza raccordi

Aufsätze Wasserstrahl-Reinigungspistole
Tips for water jet pistol
Toberas para pistola-lavatoria de chorro de agua
Raccordi per pistola lavatrice a getto d'acqua



Fig. 1

1569-0001

für Flaschen
for bottles
para botellas
per bottiglie



Fig. 2

1569-0002

für Record-Spritzen Konen
for cones of record syringes
para conos de jeringas Record
per coni di siringhe Record



Fig. 3

1569-0003

für Katheter
for catheters
para catèteres
per cateteri



Fig. 4

1569-0004

für Drainageschläuche
for drainage tubings
para tubos de drenaje
per tubi di denaggio



Fig. 4

1569-0005

für Hohlgefäße
for receptacles
para recipientes
per recipienti



Fig. 6

1569-0006

für Kanülen mit Record-Konus
for hypodermic needles with
Record-cone
para agujas de inyección con
cono Record
per aghi ipodermici con cono
record



Fig. 7

1569-0007

für Kanülen mit
Luer-Konus
for hypodermic needles
with Luer cone
para agujas de inyección con
cono Luer
par aghi ipodermici con
con Luer



Fig. 8

1569-0008

für Meß- und Vollpipetten
for measuring and volumetric
pipettes
para pipetas de medida y
volumétricas
per pipette comuni e
graduate

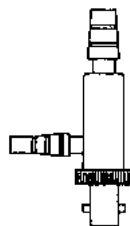

Fig. 9

1569-0009

für feine Pipetten
for fine pipettes
para pipetas finas
per pipette fine



Fig. 10

1569-0010

Reinigungsaufsatz
31 cm, gerade
cleansing tip,
31 cm, straight
tobera de limpeza
31 cm, recta
per lavaggio, 31 cm
retto

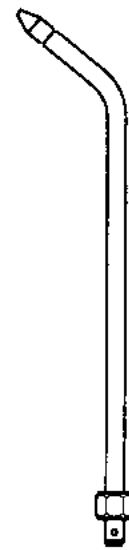

Fig. 11

1569-0011

Reinigungsaufsatz
30 cm, abgebogen
cleansing tip,
30 cm, curved
tobera de limpeza
30 cm, curva
per lavaggio, 30 cm
curvo



1569-0013

Überwurfmutter, 3/4 Zoll
Coupling, 3/4 inch
Tuerca-hembra, 3/4 pulgada
Dado premistoppa, 3/4 pollici

085

**Instrumentenspray
Instrument Spray Oil
Lubricante para instrumentos
Spray lubrificante per strumentario**



1569-1500

**Instrumentenspray
Instrument Spray Oil
Lubricante para instrumentos
Spray lubrificante per strumentario**



a x b x c

1569-1508 245 x 65 x 3 mm



a x b x c

1569-1509 420 x 65 x 3 mm



a x b x c

1569-1510 270 x 65 x 8 mm

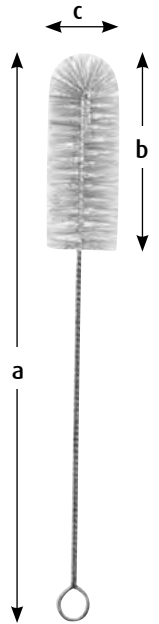

a x b x c

1569-1511 285 x 75 x 7 mm



a x b x c

1569-1512 270 x 65 x 12 mm



a x b x c

1569-1513 215 x 60 x 13 mm



a x b x c

1569-1514 215 x 70 x 15 mm



a x b x c

1569-1515 215 x 65 x 20 mm



a x b x c

1569-1516 215 x 65 x 25 mm



a x b x c

1569-1517 215 x 65 x 30 mm



1569-1518

Satz mit 5 Bürsten bestehend aus 1569-1513 - 1569-1517
Set of 5 brushes consisting of 1569-1513 - 1569-1517
juego de 5 cepillos compuesto de 1569-1513 - 1569-1517
set a 5 spazzole composto da 1569-1513 - 1569-1517

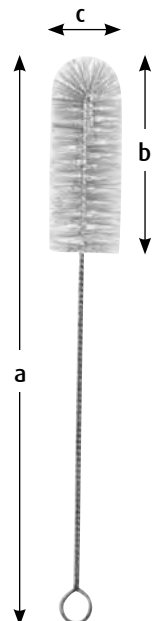



a x b x c

1569-1519 275 x 65 x 12 mm



a x b x c

1569-1520 275 x 80 x 15 mm



a x b x c

1569-1521 300 x 120 x 30 mm



a x b x c

1569-1522 320 x 130 x 50 mm



a x b x c

1569-1523 360 x 140 x 35 mm



a x b x c

1569-1524 420 x 180 x 40 mm

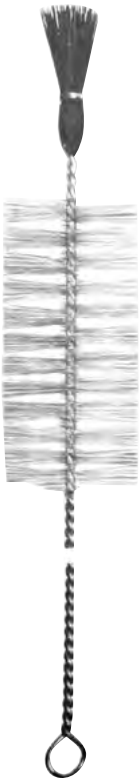

a x b x c

1569-1525 500 x 180 x 60 mm



a x b x c

1569-1526 490 x 180 x 80 mm



a x b x c

1569-1527 450 x 180 x 60 mm



a x b x c

1569-1528 420 x 130 x 75 mm



a x b x c

1569-1529 330 x 130 x 50 mm



konisch
conical
cónico
conico

a x b x c

1569-1530 400 x 190 x 8/20 mm



konisch
 conical
 cónico
 conico

a x b x c

1569-1531 300 x 110 x 18/33 mm



konisch
 conical
 cónico
 conico

a x b x c

1569-1532 320 x 70 x 15/25 mm



konisch
 conical
 cónico
 conico

a x b x c

1569-1533 420 x 60 x 8/15 mm



a x b x c

1569-1534 1000 x 180 x 16 mm



1569-1295 210 x 95 mm



1514-7040 Ø 325 mm

Inhalt 15l
 capacity 15l
 capacidad 15l
 capacità 15l



1514-7041

Deckel
 Lid
 tapa
 coperchi



1514-7058 58,0 cm / 22³/₄"



SAUERBRUCH

1514-7455 55,0 cm / 22"



Inhaltsverzeichnis
Alphabetical Index
Índice alfabético
Índice alfabético

A

Abfalleimer	886
Abfallzange	886
ABRAHAM Tonsillennmesser	830
ADAMS Serviettenhalter	808
ADLERKREUTZ Chirurgische Pinzette	83
ADSON Anatomische Pinzette	78
ADSON Chirurgische Pinzette	82
ADSON Klemme	124
ADSON MIKRO-Chirurgische Pinzette	82
ADSON Nadelhalter	303
ADSON Raspatorium	420
ADSON Saugrohr	232
ADSON Spiralbohrer	358
ADSON Wundhaken	559
ADSON Wundsperrerr	198,203,204
ADSON Wundsperrerr	205
ADSON-BROWN Chirurgische Pinzette	82
AEBLI MICRO-Augenschere	723
ALAN-PARKS Analspreizer	625
ALAN-PARKS Mittelvalve	625
ALAN-PARKS Seitenvalve	625
ALDERDYCE Elevator	426
ALEXANDER Flachmeißel	381
ALEXANDER Hohlmeißel	381
ALEXANDER Rippen-Raspatorium	420
ALEXANDER Uterus Biopsiezange	682
ALLEN Darm- und Gewebefäßzange	607
ALLIS ATRAUMA Klemme	604
ALLIS Darmfaßklemme	604
ALLIS-ADAIR Darmfaßklemme	604
ALLIS-BABY Darmfaßklemme	604
ALLISON Lungenspatel	486
ALLPORT Retractor	197
ALM Wundsperrerr	197
Aluminium Stimmgabel	742
Amputationskomprimierer	354
Amputationsmesser	12,13
Anatomische Pinzette	78-80
Anatomische Pinzette GRAEFE	88
Anatomische Pinzette Standard	78
Anatomische Pinzette USA MODELL	78
Anatomisches Skalpell	2
ANDERSON-ADSON Wundspreizer	198
ANDREW Zungendrucker	816
ANDREWS-PYNCHON Saugrohr	238
Anestrophon Stethoskop	251
Anlegezange für Bulldogklemme	491
Anlegezange für TITAN- Bulldogklemme	104
Ansatz mit konischem Gewinde	760
Ansatz, Olivförmig	760
AQUAJET Aufsatz für Reinigungspistole	879
AQUAJET Reinigungspistole komplett	878
ARRUGA Nadelhalter	295
ARTERIENKLEMMEN	107-119
Arterienklemmen, Korn-u. Tupferzangen	101-152
ASCH Septumzange	801
ASEPTIC Handwaschbürste	858
Aufhängevorrichtungen	859,860
AUFRICT (WIENER) Nasenraspel	793
AUFRICT Nasenhaken	798
AUFRICT Nasenhaken	800
Augennadel	291
AUSTIN MIKRO-Attikus-Dissektor	737
AUSTIN MIKRO-Knüpfpinzette	96
AUVARD Spekulum	661
AXENFELD Tränendrüsenhäkchen	710
AYER Chalazionspinzette	722
AYRE Konsiationsmesser	2

B

BABCOCK ATRAUMA Klemme	606
------------------------	-----

BABCOCK Darmfaßklemme	606
BABINSKI Hammer	249
BABY-ADSON Klemme	124
BABY-BABCOCK Darmfaßklemme	606
BABY-BAILEY Rippenspererr	485
BABY-BALFOUR Bauchdeckenhalter	215
BABY-COLLIN Wundspreizer komplett	212
BABY-DOYEN ATRAUMA Darmklemme	616
BABY-DOYEN Darmklemme	608
BABY-DUPLEX Stethoskop	251
BABY-GILLIES Nadelhalter	308
BABY-KERN Knochenhaltezange	445
BABY-MIKULICZ Peritoneumklemme	137
BABY-MIXTER Klemme	123
BABY-OVERHOLT Arterienklemme	111
BABY-ROUX Wundhaken	192
BABY-SATINSKY Gefäßklemme	487
BABY-TISCHLER Biopsiezange	683
BACKHAUS Tuchklemme	143
BADGLEY Laminiketomie-Spreizer	568
BAHNSON-DEBAKEY Aneurysmaklemme	511
BAILEY Rippenspererr	485
BAILEY-GIBBON Rippenspererr	485
BAINBRIDGE ATRAUMA Klemme	496
BAINBRIDGE Klemme	122
BAKES Gallenkanaldilatator	632
BAKES Gallensteindilatoren Satz	632
BALFOUR Drahtvalve	217
BALFOUR Mittelvalve	217
BALFOUR US-TYPE Bauchdeckenhalter	216
BALL+SOCKET Papier-Tuchklemme	144
BALLENGER Schwingmesser	780
BALLENGER Septum-Hohlmeißel	785
BALLENGER-HAJEK Septum Elevator	782
BARANY Lärmtrommel mit Ohrolive	745
BARANY Ohr Olive	745
BARBARA MIKRO-Ohrnadel	735
BARBARA Ohrnadel	736
BARNHILL Ringmesser	803
BARR Mastdarmspekulum	623
BARRAQUER (COLIBRI) Augenlidspererr	704
BARRAQUER (COLIBRI) Fixierpinzette	719
BARRAQUER Cilienpinzette	91
BARRAQUER Iridektomiescheren	725
BARRAQUER Nadelhalter	296-297
BARRAQUER-KATZIN (COLIBRI) Fixierpinzette	719
BARRAQUER-KATZIN Fixierpinzette	719
BARRAQUER-TROUTMAN Nadelhalter	296
BARRET Hakenzange	669
BARRON Saugkanüle	236
Batteriegriff	272,279
Batteriegriff für Diagnostikbestecke	259
Bauchdeckenhalter	212-222
Bauchspatel	195
BAUMGARTNER Nadelhalter	302
BEACHAM Amniotom	671
BECK ATRAUMA Gefäßklemme	516
BECKMANN Nasenspekulum	765
BECKMANN Ringmesser	802,803
BECKMANN Wundsperrerr	205
BECKMANN-ADSON Wundsperrerr	206
BECKMANN-EATON Wundsperrerr	206
BEEBEE Drahtschere	50
BEER Cilienpinzette	91
Begrenzungsplatten mit Schlitz	372
BELLUCCI MIKRO-Absaugrohr komplett	235
BELLUCCI MIKRO-Ohrschere	731
BELLUCCI MIKRO-Saugkanüle	235
BENGOLEA Klemme	119
BENNETT Knochenheber	432
Bereitschaftsboxen	865
BERGER Linse	263
BERGER Stirnlupe komplett	263
BERGMANN Gipssäge	348
BERGMANN Hammer	398

BERGMANN Hammer	399
BERGMANN Verbandschere	345
BERLINER Hammer	248
BERNHARD Tuchklemme	144
BERTILLON Schädel Meßzirkel	253
BETHUNE Rippenschere	474
BEYER Hohlmeißelzange	456
BEYER Ohrstanze	750
BIER Amputationszange	352
BIER Ersatz-Sägeblatt	352
BIER Kanüle	242
BILLEAU Ohrschlinge	753
BIRCHER Meniskusmesser	436
BIRCHER-GANSKE Meniskusmesser	442
BIRKETT Klemme	125
BISHOP-HARMAN Iris Pinzette	719
BLAKE Galleinsteinzange	634
BLAKE Kürette	692
Bleihand für Erwachsene	467
Bleihand für Kinder	467
BLOHMKE Tonsillenzange	834
BLOUNT Knie- und Wundhaken	434
BLOUNT Knochenheber	433
BLUMENTHAL Hohlmeißelzange	455
Blutdruckmessapparat	264
Blutdruckmessapparat Wandmodell	265
BODENHAMMER Mastdarmspekulum	622
BOETTCHER Schere	46
BÖHLER Extensionsbügel für Arm	371
BÖHLER Extensionsbügel für Oberschenkel	371
BÖHLER Hohlmeißelzange	456
BÖHLER Knochensplitterzange	463
Bohrdraht Lagergestell für Drähte	378
Bohrdrahtspender, mehrfach	377
Bohrfutter mit T-Griff komplett	358
Bolzenschneider	366
BONACCIOLO Nahtpinzette	721
BONN MOD. Irispinzette	719
BONN MOD. Schere	38
BONNEY Chirurgische Pinzette	86
BOSE Trachealhäkchen	844
BOUCHERON Ohrspekulum	741
BOWMAN Augensonde	716
BOWMAN Diszisionsnadel	707
BOWMAN Sperrelevator	704
BOYS-ALLIS Gewebefäßzange	605
BOZEMANN Schlingendreher	336
BOZEMANN Tupferzange	150
BOZEMANN Uterusschere	28
BOZEMANN-DOUGLAS Schwammzange	150
BRAND Sehnenfaßzange	440
BRAUN Hakenzange	670
BRAUN Hakenzange	674
BRAUN Kranioklast	701
BRAUN Kropffaßzange	849
BRAUN Uterus Depressor	668
BRAUN-STADLER Schere	29
BREISKY Spekulum	662
BRODIE Sonde	225
BROPHY Anatomische Pinzette	79
BROPHY Chirurgische Pinzette	84
BROPHY-SULLIVAN Schere	36
BROWN Chirurgische Pinzette	86
BROWN Nadelhalter	302
BRUENINGS Brochosaufsatz	839
BRUENINGS Mundspatel	817
BRUENINGS Scharfe Nasenzange	768
BRUENINGS Septummesser komplett	781
BRUENINGS Tonsillennmesser	830
BRUENINGS Tonsillennschnürer	835
BRUENINGS Verlängerungsrohr	836
BRUNNER ATRAUMA Klemme	619
BRUNNER Ferrozell Führungshohlsonde	336
BRUNNER Führungshohlsonde	334
BRUNNER Rippen und Sternumschere	473

Inhaltsverzeichnis
Alphabetical Index
Indice alfabético
Indice alfabético



BRUNNER Unterbindungsnadel 333
 BRUNNER Wundhaken 179-181
 BRUNS Gipsschere 346
 BRUNS Scharfer Löffel 404,405
 Bruststütze 284
 Bruststütze mit Laryngoskophalter 284
 BRYANT Korn- und Tupperzange 149
 BUCHWALD Zungenspatel 817
 BUCK Hammer 249
 BUCK Ligaturschere 52
 BUCK Ohrhebel 748
 BUCK Ohrkürette 751,752
 BUCK-GRAMCKO Knochenhebel 427
 BUCKLEY Wundsperrer 196
 BUJIE Klemme 121
 BULEAU Trokar 231
 Bulldogklemme 101-152
 BUMENTHAL Hohlmeißelzange 455
 BUMM Uterus Kürette 691
 BUNELL Handbohrapparat 359
 BUNNEL Sehnenschäler 438
 BUNNELL Sehnendurchzugsonde 439
 BUNT Sterilisierklammer 863
 BURFORD Rippensperrer aus ALUMINIUM 477
 BURKE Biopsiezange 683
 Bürstenabwurfbehälter 860
 BUSCH Nabelschnurschere 29

C

CAPLAN Nasenschere 775
 CAROLL Finger Goniometer 253
 CAROLL Sehnenfaßinstrument 441
 CARPENTER Tonsillennmesser / Dissektor 831
 CARREL Arterienklemme 108
 CASPAR Drehschlüssel, allein 569
 CASPAR Durahaken 560
 CASPAR Haken mit Kungelschnellverschluss 569,570
 CASPAR Laminektomie-Spreizer 571
 CASPAR Laminektomie-Spreizer komplett 569-574
 CASPAR Laminektomiezeange 595,596
 CASPAR Pinzette 570
 CASPAR Rahmen 569-574
 CASPAR Seitenvulve 569,570,574
 CASPAR Spekulum 575
 CASPAR Sperrer 572
 CASPAR Valve 571
 CASTANEDA ATRAUMA Neonatal-Gefäßklemme 535
 CASTANEDA Rippensperrer aus ALUMINIUM 478
 CASTROVIEJO Augenlidsperrer 704
 CASTROVIEJO Augenschere 723
 CASTROVIEJO Augenzirkel 715
 CASTROVIEJO Doppelschiebeinstrument 717
 CASTROVIEJO Hornhautschere 726
 CASTROVIEJO Iridektomiescheren 723,724
 CASTROVIEJO Kanüle 714
 CASTROVIEJO MIKRO-Nadelhalter 298-300
 CASTROVIEJO Nahtpinzette 720
 CASTROVIEJO Rasierklängenbrecher und -halter 14
 CASTROVIEJO Spatel 712
 CASTROVIEJO-BARRAQUER Spatel 711
 CASTROVIEJO(JACOBSON) MIKRO-Nadelhalter 299
 CATLIN Amputationsmesser 12
 CAWOOD-MINNESOTA Wangen- und Lippenhalter 815
 Cerclage Draht 369
 CHAPUT Tumorfaßklemme 120
 CHARRIERE Amputationssäge 353
 CHARRIERE Ersatzsägeblatt 353
 CHEATTLE Sterilisierzange 862
 CHERON Tupperzange 149
 CHEVALIER-JACKSON Bronchoszange 838
 CHEVALIER-JACKSON Trachealkanüle 846
 CHILDE Nahtpinzette 337
 Chirurgische Nadel 288-290

Chirurgische Nadel gebogen B 288
 Chirurgische Nadel gebogen E 289
 Chirurgische Nadel gebogen G 288
 Chirurgische Nadel gebogen Ga 289
 Chirurgische Nadel gebogen Gr 289
 Chirurgische Pinzette 78-99
 Chirurgische Pinzette 81-87
 Chirurgische Pinzette Standard 81
 Chirurgische Pinzette USA MODELL 82
 Chirurgische Schere, grazil 24
 Chirurgische Schere, Standard 22-23
 Cilienpinzette 91
 CINELLI Osteotom 788
 Circumcisionsinstrument 644
 CITELLI Antrum Stanze 750, 837
 CITELLI Antrumstanze 777
 CLAR Stirnlampe 261,262
 CLEVELAND Hohlmeißelzange 454
 CLEVELAND Knochen splitterzange 462
 Clip-Set MINI-Assistent 340
 CLOVER ATRAUMA Bulldogklemme 491,492
 CLOWARD Wirbelkörperspreizer 576
 CLOWARD Wunspreizer 210,211
 COAKLEY Kiefer Trokar 232
 COAKLEY Kürette 802
 COBB Hohlmeißel 392
 COBB Raspatorium 414
 COGSWELL Saugrohr 234
 COLIN Amputationsmesser 12
 COLLIER Nadelhalter 301
 COLLIN Bauchdeckenhalter 212
 COLLIN Beckenzirkel 695
 COLLIN Dynamometer 253
 COLLIN Faßzange 120
 COLLIN Hammer 396
 COLLIN Mittelvalve 213
 COLLIN Nabelschnurklemme 700
 COLLIN Scheidenspekulum 649
 COLLIN Seitenvulve 213
 COLLIN Tupperzange 149
 COLLIN Uterus Sonde 668
 COLLIN Uterusfaßzange 675
 COLLIN Wundhaken 194
 COLLIN Wundklammerzängchen 338
 COLLIN Zungenzange 818
 COLLIN-DUVAL Faßpinzette 87
 COLLIN-LOKTITE Wundspreizer 212
 COLLYER Beckenzirkel 695
 COMCO Circumcisionsgerät 644
 CONE Schädelöffnungsinstrument 546
 CONVERSE Nasenflügelhäkchen 796,798
 CONVERSE Rhinoplastikmesser 778
 COOLEY ATRAUMA Anastomosenklemme 525
 COOLEY ATRAUMA Carotisklemme 525
 COOLEY ATRAUMA Iliaca-Klemme 525
 COOLEY ATRAUMA Katheterklemme 529
 COOLEY ATRAUMA Kindergefäßklemme 532-534
 COOLEY ATRAUMA Mehrzweck Gefäßklemme 526,527,528
 COOLEY Gefäßdilatorator 536,537
 COOLEY Rippensperrer 475
 COOLEY Saugrohr 239
 COOLEY Wundhaken 186
 COOLEY-BECK ATRAUMA Anastomosenklemmen 530
 COOLEY-DERRA ATRAUMA Anastomosenklemmen 530
 COOPER Unterbindungsnadel 331
 CORDÉS Bronchos Aufsatz 839
 CORYLLOS Wundhaken 178
 COTTLE Columella Pinzette 801
 COTTLE Hammer 397
 COTTLE Hautfaßpinzette 801
 COTTLE Knorpelquetsche mit Fasspinzette 791
 COTTLE Nasenfeile 793
 COTTLE Nasenhäkchen 796
 COTTLE Nasenhaken 800
 COTTLE Nasenspekulum 764

COTTLE Osteotom 786
 COTTLE Osteotom 786,787
 COTTLE Periostelevator 783
 COTTLE Raspator 782
 COTTLE Rhinoplastikmesser 778
 COTTLE Sattelhäkchen 800
 COTTLE Schere 47
 COTTLE-KAZANJIAN Knochen splitterzange 462
 COTTLE-NEIVERT Nasenhaken 799
 COTTLE-WALSHAM Septumzange 801
 COUPLAND Aufsatz 239
 COUPLAND Saugerhandgriff 239
 CRAFOORD Klemme 126
 CRAFOORD Schere 41
 CRAFOORD-SELLORS Klemme 126
 CRAIG Nasenpolypenzange 767
 CRAWFORD Aorta Wundhalter 182
 CRILE Arterienklemme 110
 CRILE MURRAY Nadelhalter 303
 CRILE Nervhäkchen 540
 CRILE WOOD Nadelhalter 303
 CRILE Wundhaken 194
 CRILE-RANKIN Arterienklemme 111
 CRUTCHFIELD Schädelhalter 545
 CUSCO Scheidenspekulum 648
 CUSCO Standard Scheidenspekulum 649
 CUSHING Anatomische Pinzette 80
 CUSHING Bohrer 358
 CUSHING Chirurgische Pinzette 84
 CUSHING Laminektomiezeange 592
 CUSHING Nervwurzelhaken 555
 CUSHING Wundhaken 159-161
 CUSHING Wundhaken 559
 CUZZI Abortuslöffel 699
 CZERNY Gallensteinzange 634
 CZERNY Hakenzange 674
 CZERNY Mastdarmspekulum 622

D

D'ERRICO Bohrer 358
 DAHLGREN Ersatzmesser 546
 DAHLGREN Schädelöffnungsinstrument 546
 DAHMEN Hohlmeißel 393,394
 DAHMEN Osteotom 393,394
 DALE ATRAUMA Peripheral-Gefäßklemme 519
 DANDY Dura-Septatoren 556
 DANDY Klemme 109
 DANDY Schere 45
 DARDIK ATRAUMA Gefäßklemme 522
 Darmschere 51
 DARTIGUES Uterusfaßzange 675
 DAVIDSON Wundhaken 178
 DAVIS Dura-Dissektor 558
 DAVIS Dura-Dissektor 558
 DAVIS Spatel biegsam 553
 DAVIS-BOYLE Mundsperrer 811
 DAY Ohrhäkchen 754
 DE BAKAY Gefäßscheren 44
 DE LEE Geburtszange 696
 DE MARTEL Einführungsinstrument 544
 DE MARTEL-WOLFSON Anastomosenklemme 614
 DE MARTEL-WOLFSON Klemmenhalter 614
 DE MARTEL-WOLFSON Klemmschließzange 614
 DE VILBISS Ersatzmesser 546
 DE VILBISS Schädelöffnungsinstrument 546
 DEAN Schere 48
 DEEVER Schere 25
 DEEVER Wundhaken 185-187
 DEBAKEY Atrauma Aortaklemmen 504
 DEBAKEY ATRAUMA Bulldogklemme 490
 DEBAKEY Atrauma Gefäßklemme 498, 499, 501-503
 DEBAKEY ATRAUMA Pinzette 489
 DEBAKEY Atraumatische Pinzette 489

DEBAKEY Gefäßdilator	537	DUPLAY Hakenzange	671	FIG. 3,4,5,7 Cilienpinzette	91
DEBAKEY Gefäßschere	44	DUPLEX Stethoskop	251	FILIFORM Gleitsonde	641
DEBAKEY Kindergefäßklemme	531	DUPUY-WEISS Tonsillennadel	829	Fingerring-Sägezange	469
DEBAKEY Mehrzweck-Gefäßklemmen	513,514	DURANTE Chirurgische Pinzette	86	FINOCHIETTO	476
DEBAKEY Rippensperrer	481,482	DUVAL Chirurgische Pinzette	87	FINOCHIETTO (mod.) Rippensperrer	480
DEBAKEY Seitenvalve	481,482	DUVAL Darmfäßklemme	607	FINOCHIETTO BABY Rippensperrer	476,481
DEBAKEY-DIETHRICH Bulldogklemme	105			FINOCHIETTO INFANT Rippensperrer	476
DEBAKEY-SATINSKY ATRAUMA Bulldogklemme	490	E		FINOCHIETTO Klemme	134
Deckel für Abfalleimer	886	EASTMAN Spekula groß	651	FINOCHIETTO Nadelhalter	306
Deckel für Nierenschale	876	EASTMAN Spekulum	651	FINOCHIETTO Rektumschere	42
Deckel mit dreieckiger Aussparung	872	ECHLIN Hohlmeißelzange	458	FINSEN Wundsperrerr	196
Deckel, allein	872	EICKEN-KILLIAN Nasenspülkanüle	805	FISCH Ohr Dissektor	738
DEJERINE Hammer	248	EIMALSKALPELLE	9,10	FISCHER Sehnenschäler	439
DEMEL Drahtspannzange	369	EISELSBERG Fadenschere	52	FISCHER Tonsillennmesser	830
DEMEL Drahtumführungsnadel	370	ELLIOT Griff	714	Fixierscheiben für Bohrdrähte	372
DEMEL Drahtumführungsnadel	370	ELLIOT Hornhauttrephine komplett in Etui	714	Flachmeißel	380,381,384-385,387-392
DENHARDT Mundsperrerr	809	ELLIOT Trephine	714	Flachmeißel mit Ferrozellgriff	390,391
DENHARDT Silikonbacken	809	ELLIOT Trephine	714	Flachmeißelklinge	387
DENIS-BROWNE Bauchdeckenhalter	220	ELSÄSSER Nierenfistelzange	631	Flachzange	363,364
DENIS-BROWNE Fußpinzette	87	ELSCHNIG Spatel	712	FOERSTER Schwammzange	150,151
DENIS-BROWNE Rahmen	220	ENGEL Gipsäge	348	FOMON Haken	799
DENIS-BROWNE Rahmenhaken	220	ENGL. MODELL Anatomische Pinzette	80	FOMON Nasenfeile	794
DEPONETTE Bereitschaftsbox	864	ENGL. MODELL Tuchklemme	143	FOMON Nasenhaken	797
DERF Nadelhalter	301	Enucleationsschere	34	FOMON Nasenraspel	795
DERRA ATRAUMA Gefäßklemme	516	Episiotomie-Schere	29	Fomon Nasenschere	47
DESCHAMPS Unterbindungsnadel	332,333	EPPENDORFER Uterus Biopsiezange	682	FOMON Osteotom	788
DESJARDINS Gallensteinlöffel	635	Ersatz-Lichtträger	285	FOMON Präparierschere	34
DESJARDINS Gallensteinsonde	633	Ersatz-Sägeblatt	469	FOMON Rhinoplastikmesser	778
DESJARDINS Gallensteinzange	635	Ersatz-Textil Spezialfilter	865	FOREGGER Laryngoskopbesteck	271,277,278
DESJARDINS Ligaturklemme	133	Ersatzbacke aus FERROZELL	401	FOX Lupus Kürette	850
DESMARRES Chalazionspinzette	722	Ersatzdorn	545	FRAENKEL Bronchosaufsatz	839
DESMARRES Lid Wundhaken	705	Ersatzklinge allein	11	FRANZ Bauchdeckenhalter	221
DESMARRES Wundhaken	156	Ersatzklinge für LA FORCE Ringmesser	804	FRANZ Rahmen	221
Diagnostik-Besteck	258	Ersatzklinge für Kaltlicht-Laryngoskope	279	FRANZ Rahmenhaken	221
DIAMANT Kopfschneider	366	ESMARCH Gipsmesser	348	FRANZ Valve	221
Dichtungsring	693	ESMARCH Staubbinde	355	FRAZIER Dura-Seperatoren	556
DIEFFENBACH Bulldogklemme	106	ESMARCH Verbandschere	346	FRAZIER Saugrohr	232
DIETHRICH ATRAUMA Aortaklemme	517	EVE Tonsillenschnürer	835	FRAZIER Wundhaken	559
DIETHRICH Bulldogklemme	105	EXCENTRIC Verbandschere	344	FREER Mukosamesser	779
DIETHRICH Gefäßschere	43	Extensionsbügel	372	FREER Schleimhauthäkchen	799
DIETHRICH-HEGEMANN	43			FREER Septum Elevator	781,782
DINGMANN Knochenhaltezange	442	F		FREER Septum Messer	779
DINGMANN Mundsperrerr	813	Fadenfänger	336	FREER Septummeißel	784
DINGMANN Zungenspatel	813	Fadenfänger für Tourniquet RUMEL-BELMONT	541	Fremdkörperschlinge Standard	708
Dissektoren, Elevatorien	425,426	FANSLER Rektoskop	626	FRIEDMANN Hohlmeißelzange	453
DIX Doppelschiebeinstrument	717	FARABEUF Knochenhaltezange	446	FRIEDMANN-VICKERS Hohlmeißelzange	453
DIXON-LOVELACE Arterienklemme	111	FARABEUF Raspatorium	416	FRITSCH Wundhaken	176
Doppelinstrument umschraubbar	717	FARABEUF Wundhaken	191	FROSCH Knochenhaltezange	444
DOUGLAS Cilienpinzette	90	FARABEUF Wundhaken	191	FRYKHOLM Hohlmeißelzange	459
DOUGLAS Cilienpinzette	91	FARABEUF-LAMBOTTE Knochenhaltezange	446	Führungshohlsonde	334
DOUGLAS Trokar	231	FARRELL Phlebotomiseur	229	Führungshohlsonde, Ferrozell	337
DOYEN ATRAUMA Darmklemme	616	FARRELL Wattetäger	229	FULLER MIKRO-Ohrzängchen	731
DOYEN Bauchdeckenhaken	176	FARRIOR Ohrspekulum	740		
DOYEN Darmklemme	608	FAULKNER Kürette	802	G	
DOYEN Hammer	395	FAURE Peritoneumklemme	137	GALLAHER Nasenraspel	793
DOYEN Hohlsonde	225	FAURE Probeexzisionszangen	680	Gallenkanal- und Niernstielklemme	134,135
DOYEN Kette mit Gewicht	221	FAVALORO Gefäßschere	45	GELLHORN Probeexzisionszangen	680
DOYEN Myominstrument	676	FEHLAND ATRAUMA Rektum Klemme	620	GELPI Wundsperrerr	209
DOYEN Rahmenhaken	221	FELCHENFELD Splitterpinzette	90	GELPI-LOKTITE Wundsperrerr	209
DOYEN Raspatorium	417,418	FEIN Watteträger	229	GEMINI Präparier- und Ligaturklemme	129
DOYEN Scheidenspekulum	662	Feine chirurgische Schere	40	GERALD Anatomische Pinzette	80
DOYEN Schere	27	Feine chirurgische Scheren	36-40	GERALD Chirurgische Pinzette	84
DOYEN Spekulum	659	FELDHEIM Band	468	GERSTER Knochenhalteklammer	361
DOYEN Uterus Zange	674	FELDHEIM Finger Instrument	468	GERZOG Hammer	398
DOYEN-JANSEN (MOLT) Mundsperrerr	809	FERGUSSON Gallensteinlöffel	636	Gewebefäßzangen	120
DOYEN-STILLE Wundhaken	175	FERGUSSON Klemme	121	GIERTZ-STILLE Sternumschere	472
Draht-Fasszange	363-365	FERGUSSON Knochenhaltezange	444	GIGLI Drahtsäge	544
Draht-Flachzange	363-365	FERRIS-SMITH Chirurgische Pinzette	85	GIGLI Griff für Drahtsäge	544
Draht-Kneifzange	366	FERRIS-SMITH Laminektomie zange	599	GIL-VERNET Type Wundhaken	161
Drahtumführungsnadel	370	FERRIS-SMITH-KERRISON Laminektomiestanze	591	GILLIES Chirurgische Pinzette	83
Druck-Manometer	694	FERROZELL Führungshohlsonde	336	GILLIES Hauthäkchen	851
DUBOIS Schere	28	Ferrozellgriff für auswechselbare Meißelklinge	387	GILLIES Nadelhalter	308
DUEHRSEN Anatomische Pinzette	80	Ferrozellhammer	400	GLOVER ATRAUMA Bulldogklemme	491,498
DUEHRSEN Chirurgische Pinzette	85				

Inhaltsverzeichnis
Alphabetical Index
Indice alfabético
Indice alfabético

GLOVER ATRAUMA Gefäßklemme 515
 GLUCK Rippenschere 472
 GOELET Wundhaken 193
 GOLDMANN-FOX Schere 49
 GOLDSMITH (THUDICHUM) Nasenspekulum 762
 GOMEL MIKRO-Schere 17
 GOMEL Nadelhalter 297
 GOOD Gefäßschere 46
 GOODELL Endospekula 678
 GOSSET Bauchdeckenhalter 215
 GOSSET Mittelvalve 215
 GRAEFE Irishäkchen 708
 GRAEFE Strabismushäkchen 710
 GRAEFE Cystotom 708
 GRAEFE Haken 154
 GRAEFE Irispinzette 718
 GRAEFE Starmesser 706
 GRAHAM Wundhaken 559
 GRAVE Spekulum 650
 GRAY Präparierklemme 133
 GREEN-ARMYTAGE Uterusklemmzange 698
 GREGORY ATRAUMA Carotisklemme 492
 GREGORY ATRAUMA Profundaklemme 518
 GREGORY SOFT ATRAUMA Carotisklemme 492
 Griff für Biopsiezange 684
 Griff für Ringstripper 228
 GRONINGEN Nervwurzelhaken 555
 GROSS Ohrlöffel und Häkchen 752
 GROSS Tuchklemme 146
 GROSS-MAIER Kornzange 148
 GUEDEL-NEGUS Laryngoskopbesteck 269
 GUILÉN Saugraspatorium 805
 Gummibacken für YOUNG Zungenzange 818
 Gummiringe für Hämorrhoidal Ligatur 627
 GUTHRIE Doppelfixierhäkchen 709
 GUTHRIE Haken 154
 GUYON ATRAUMA Nierenstielklemme 134
 GUYON Harnröhrenbougie 641
 GUYON Katheter 644
 GUYON Klemme 134
 Gynäkologische Scheren mit Hartmetallschneiden 61

H

HABERER Bauchspatel 195
 HACKSTOCK Flachzange 363
 HAIGHT Rippensperrer 479
 HAJEK Hammer 398
 HAJEK Keilbeinstanze 776
 HAJEK-KOFLER Keilbeinstanze 776
 HALLE Duramesser 560
 HALLE Scharfer Löffel 407
 HALLE Septum Elevator 781
 HALSEY Nadelhalter 302
 HALSEY Nadelhalter 302
 HALSTEAD-MOSQUITO Klemme 106,107
 Halteplatte für Tunnelier-Aufsätze 538
 Hammer 393-401
 Hammer mit Kunststoffgriff 400
 Hammer, Rückschlagfrei mit Kunststoffgriff 400
 HANK Uterus Dilator 666
 HARDY Eukleator 562
 HARDY Hypophysen MIKRO-Kürette 561
 HARDY Implantationsgabel 562
 HARKEN 488
 HARKEN ATRAUMA Aortaklemme 507
 HARKEN Gefäßklemme 488
 HARMS Trabekularsonde 716
 HARRINGTON Wundhaken 184
 HARTMANN Arterienklemme 108
 HARTMANN Hohlmeißelzange 454
 HARTMANN Nasenspekulum 763
 HARTMANN Nasentamponzange 766
 HARTMANN Ohrhäkchen 753

HARTMANN Ohrkatheter 746
 HARTMANN Ohrlöffelzängchen 749
 HARTMANN Ohrspekulum 740
 HARTMANN Ohrzängchen 748,749
 HARTMANN Scharfe Nasenzange 769
 HARTMANN Stimmgabel 742-744
 HARTMANN Tonsillenzange 837
 HARTMANN Zungendrucker 816
 HARTMANN-HALLE Nasenspekulum 762
 HARTMANN-HOFFMANN Ohrlöffelzängchen 749
 HARTMANN-WULLSTEIN Ohrzängchen 749
 HARY-FAHLBUSCH Eukleator 562
 HAYES ATRAUMA Klemme 619
 HEANEY Klemme 140
 HEANEY Nadelhalter 305
 HEANEY-BALLENTINE Hysterektomieklammer 140
 HEANEY-KANTER Hysterektomieklammer 141
 HEANEY-REZEK Hysterektomieklammer 140
 HEATH Hammer 399
 HEATH Ligaturschere 52
 HEBRA Chalazionslöffel 713
 HEGAR Nadelhalter 307
 HEGAR Uterine Dilator 663-665
 HEGENBARTH Nahtpinzette 338
 HEIFETZ Spatel 553
 HEIFETZ Tumorzange 93
 HEIMING Nierensteinzange 630
 HEISS Klemme 123
 HEISTER Mundsperrer 809
 HEMINGWAY Doppellkürette 409,410
 HENKE Tonsillendissektor 832
 HENLEY Mittelvalve 202
 HENLEY Wundspreizer 202
 HENNIG Gipspreizer 349
 HEPP-SCHMIDT MIKRO-Schere 17,19
 HERRICK Nierenstielklemme 136
 HESS Bulldogklemme 106
 HEYMANN Scharfe Nasenzange 767
 HEYMANN Schere 47
 HEYWOOD-SMITH Polypenfasszange 628
 HIBBS Hohlmeißel 385
 HIBBS Meißel 385
 HIBBS Osteotom 384,385
 HIRSCHMANN Rektoskop 625
 HOFF Tuchklemmen 145
 HOFFMANN Schlauchklemme 863
 Hohlmeißel 380,381,383-385,387-394
 Hohlmeißelklinge auswechselbar 387
 Hohlmeißelzangen 453 - 460
 Hohlsonde 224,225
 Hohlsonde mit Knopf 225
 HOHMANN Knochenhebel 428-431
 HOHMANN-ALDINGER 431
 HOKE Meißel 384
 HOLINGER Operations-Laryngoskope 281
 HOLSHER Nervwurzelhaken 554
 HOLTH Kapselstanze 715
 HOLZ Mundspatel 817
 HOLZHEIMER Wundspreizer 197
 HOPKINS Gipsmesser 348
 HORSLEY Dura-Septatoren 556
 HÖSEL Wundhaken 175
 HOUSE Kürette 739
 HOUSE MIKRO-Messsonde 738
 HOUSE Saugkanüle 236
 HOUSE-DIETER Ohrzängchen 732,731
 HUBER Universal Griff 838
 HUDSON Bohraparat 358
 HUDSON Fräser 358
 HUMBY Dermatome 11
 HUMBY Dermatome Ersatzklinge 11
 HUNT Tumorzange 94
 HUNTER Splitterpinzette 89
 HURD Tonsillendissektor 831
 HURD Tonsillennadel 829

HUSFELDT ATRAUMA Peripherale-Gefäßklemme 521
 Hysterektomieklammer 138-142

I

Incisions-Schere 25
 INGE Wirbelkörperspreizer 576
 Innendose, Deckel und Boden 294
 Instrumente zur Schädelöffnung 544
 Instrumentenbehälter 873
 Instrumentenkästen 873
 Instrumentenspray 880
 Instrumententablett 871
 Intima Spatel 539
 IOWA Blasenlange 672
 IOWA Kanüle 240
 Iris Schere 37
 ISRAEL Wundhaken 167
 ITERSON Trachealhäkchen 844
 IUP-Fasszange 685
 IVES-FANSLER Kunststoff-Obturator 625
 IVES-FANSLER Rektoskop 625

J

JACKSON Operations-Laryngoskope 281
 JACKSON Scheidenspekulum 651
 JACKSON Trachealhäkchen 844,845
 JACOBS Hakenzange 672
 JACOBSON Doppelsonde 562
 JACOBSON MIKRO-Schere 16
 JAEGER Lidplatte 705
 JAEGER-GRIESHABER Lanzenmesser 706
 JAMESON Meßschieber mit Einteilung 254
 JAMESON Präparierschere 39
 JAMISON Nadelhalter 305
 JANET Wund-und Blasenpritze 246
 JANET Zylinder 246
 JANSEN (GRUENWALD) Nasentamponpinzette 766
 JANSEN Hohlmeißelzange 454, 456
 JANSEN Hohlmeißelzange 456
 JANSEN Ohrkürette 752
 JANSEN Wundsperrer 197
 JARCHO Hakenzange 669
 JAVID ATRAUMA Carotis-Shuntklemme 523
 JENNINGS Mundsperrer 814
 JOBSON-HORNE Watteträger 229
 JOHNS-HOPKINS Bulldogklemme 106
 JOHNS-HOPKINS Klemme 125
 JOHNSON Nadelhalter 306
 JOLL (FRIEDMAN) Wundspreizer 208
 JOLL (FRIEDMANN) Wundspreizer 208
 JONES Tuchklemme 143
 JOSEPH Nasenfeile 792
 JOSEPH Nasensäge 791
 JOSEPH Raspator 783
 JOSEPH Rhinoplastikmesser 778
 JOSEPH Rhinoplastikmesser 778
 JOSEPH Schere 35
 JOSEPH Schleimhauthäkchen 799
 JOSEPH Septum Elevator 781
 JOSEPH-MASING Septum Elevator 783
 JUDD-ALLIS Darmaßklemme 605
 JUDD-MASSON Blasenpreizer 639
 JUDD-MASSON Mittelblatt 639
 JURASZ Kehlkopfpolypenzange 840

K

KABIERKE Ersatzflasche 757
 KABIERKE Ohrkanüle 757
 KABIERKE Pulverbläser komplett 757

LUCAE Pinzette	747	MC GIVNEY Häorrhoidal Ligator	627	MIKRO-Tonsillenzange	834
LUCAE Stimmgabel	744	MC INDOE Anatomische Pinzette	79	MIKULICZ	188
LUCAE Trommelfellnadel	755	MC INDOE Gefäßschere	45	MIKULICZ Hysterektomieklammer	139
LUER Hohlmeißelzange	455	MC INDOE Knochensplitterzange	463	MIKULICZ Peritoneumklammer	137
LUER Insulin Spritze	245	MC INTOSH Laryngoskopspatel	270,275,276	MIKULICZ Tonsillenzange	834
LUER LOCK Kanüle	714	MC IVOR Mundsperrer	812	MILLER Laryngoskopbesteck	267,268,274
LUER Polypenfasszange	628	MC IVOR Mundsperrer-Rahmen	812	MILLER-BABY Laryngoskopbesteck	267
LUER Schraubadapter	538	MC IVOR Zungenspatel	812	MILLER-COLBURN Doppelkürlette	410
LUER Trachealhäkchen	844	MC KENTY Septum Elevator	781,782	MILLER-COLLBURN Knochenfeile	421,422
LUER Trachealkanüle	846	MC KENZIE Clips und Anlegezange	547	MILLIGAN	201
LUER Wundhaken	194	MC KENZIE Klammerblock	547	MILLIGAN Dura-Seperatoren	556
LUER-KOERTE Gallensteinlöffel	635	MC KENZIE Silberklammer	547	MILLIN ATRAUMA Prostataektomieklammer	638
LUER-LOCK Dreiweghahn	244	MC KENZIE Spiralbohrer	358	MILLIN Blasenhalsspreizer	638
LUER-LOCK Wund- und Blasenspritze	246	MC QUIGG-MIXTER Klemme	134	MILLIN Blasenpreizer	639
LUER-LOCK Zwischenstück	244	MCLEAN-LUIKART Geburtszange	697	MILLIN Fadenführungszange U-Form	638
Luftpumpe für Komprimeter	354	MCLEAN-TUCKER Geburtszange	697	MILLIN Kaltlichtaufsatz für Fiberoptik	639
LUKENS Tymushaken	845	MEAD Hammer	397	MILLIN Mittelblatt	639
LUNIATSCHKEK Tamponstopfer	833	MEAD Hohlmeißelzange	454	MILLIN Prostataklammer Allis-Form	638
		Medizinbecher	874	MILLIN Prostataklammer T-Form	638
		MEEKER Präparier- und Ligaturklammer	131	MILLIN Rahmen allein	639
M		Mehrweckschale	871	MILLIN Seitenvalve	639
MAGILL Katheterzange	266	MELLINGER Augensperrer	704	MINI MCGEE Alligator Ohrzängchen	729
MAGILL Saugrohr	235	MELLINGER-AXENFELD Sperr-Elevator	704	MINI-FRIEDMANN Hohlmeißelzange	453
MAINGOT Hysterektomieklammer	141	MENGHINI Kanüle	241	MINI-GEMINI Präparier- und Ligaturklammer	128
MALTZ Nasenraspel	792	MENISKUSMESSER	436,437	MINI-HOHMANN Knochenhebel	427
Manometer für Komprimeter	354	MERCEDES Seitenvalve	484	MINI-LAMBOTTE Meißel	382
Manometer mit Gummiball	265	MERCEDES Sperrer	484	MINI-LANGENBECK Wundhaken	156
MARKWALDER Knochensplitterzange	462	MERCEDES Thorax Sperrer	484	MINI-LEXER Hohlmeißel	388
MARQUARDT Hohlmeißelzange	457	Meßbecher	869	MINI-LEXER Meißel	388
MARTEL Klemme	121	Meßschieber	254	MINI-ROUX Wundhaken	192
MARTIN ATRAUMA Peripheral-Gefäßklemme	520	Meßstab	255	MINI-TOWNSEND (BABY-TISCHLER) Biopsiezange	684
MARTIN Beckenzirkel	695	Metall-Katheter für Frauen	642	MINI-TOWNSEND (BABY-TISCHLER) Biopsiezangen-Aufsatz	684
MARTIN Bürstenspender	858	Metall-Katheter für Männer	642	MINI-TOWNSEND Biopsiezange	683
MARTIN Ersatzsägeblatt für Fingersäge	469	Metallbehälter für Tunnelier-Set	538	MIXTER Gallensteinzange	635
MARTIN Fingerringssäge	469	Metallhammer	401	MIXTER Klemme	132-134
MARTIN Knochenhalte-zange	442	Metallolive	760	MIXTER-CRAFOORD Ligaturklammer	126
MARTIN Tunnelier-Set	538	METHOT Watteabfallbehälter	875	MIXTER-O'SHAUGNESSY Klemme	132
MARTIN Uterus Sonde	668	METHOT Wattespender	875	MOD. USA Nabelschnurrschere	29
MARTIN Wundhaken	177	METZENBAUM Nadelhalter	303	Mod. WIEN Fadenknoter	336
MARTIN-IDEAL Finger- und Zehennagelbohrer	468	METZENBAUM Schere	30	MOELTGEN Winkelmesser	253
MARTIN-VICKERS Handhalter	467	METZENBAUM-Baby Schere	30	MOGEN Beschneidungsinstrument	644
MARTINI Doppelöffel	409	METZENBAUM-FINO S Schere	34	MOHR Quetschhahn	763
MASING Raspatorium	783	METZENBAUM-FINO Schere	33,34	MOLDENHAUER Fremdkörperhebel	753
MASS-GENERAL-HOSPITAL Nadelhalter	303	METZENBAUM-NELSON Schere	31	MOLLISON Wundsperrer	200
MASSON Nadelhalter	305	MEYER Fremdkörperhohlmeißel	708	MOORE Gallensteinlöffel	636
MASTIN Muskelklemme	849	MEYERDING Wundhaken	157,185	MORRIS Wundhaken	184
MATHIEU Fremdkörperzange	645	MEYERDING Wundhaken	185	MORRIS-DEBAKEY Aortaklemme	510
MATHIEU Halter	659	MEYHOEFER Chalazionslöffel	713	MORSE Sternumspreitzer	483
MATHIEU Mastdarmspekulum	624	MICHEL Kehlkopfspiegel	842	MORSE-FAVALORO Sternumspreitzer	483
MATHIEU Nadelhalter	309	MICHEL MOD. Zängchen	338	MOSQUITO-DANDY Arterienklemme	109
MATHIEU Spektula	659	MICHEL Nahtpinzette	337	MOSQUITO-DEBAKEY ATRAUMA Klemme	493
MATHIEU Wundhaken	193	MICHEL Wundklammern	339	MOYNIHAN Galleinsteinsonde und -löffel	633
MATHIEU-KOCHER Nadelhalter	309	MICHEL Zängchen	338	MOYNIHAN Hysterektomieklammer	138
MATHIEU-RYDER Nadelhalter	309	MIDDELDORPF Wundhaken	173,176	MÜLLER-VERBRUGGE Knochenhebel	431
MATSON Rippen-Raspatorium	420	MIDDELTON-JANSEN Septumzange	775	Mundbecher	875
MAUNDER Mundkeil	808	MIKRO- Raspatorium	564	MURPHY-LANE Luxationshebel	433
MAYFIELD Hohlmeißelzange	456	Mikro-Adson Anatomische Pinzette	78	MUSEUX Hakenzange	672
MAYO Gallensteinlöffel	636	MIKRO-ADSON Klemme	124	Myrtenblattsonde	224
MAYO Schere	25	MIKRO-Augenschere	723		
MAYO Sonde	633	MIKRO-Dissektor für Hypophysektomie	564	N	
MAYO Sterilisierklammer	863	MIKRO-Elevator	425	NABATOFF Handgriff allein	227
MAYO-ADAMS Wundspreizer	208	MIKRO-Fasszängchen für Hypophysektomie	565	NABATOFF Krampfader Besteck	227
MAYO-BLAKE Galleinsteinzange	634	MIKRO-Fasszange	600,601	NABATOFF Kunststoff Sondenspitze	227
MAYO-HARRINGTON Schere	26	MIKRO-Häckchen für Hypophysektomie	564	NABATOFF Metalltueti	227
MAYO-HEGAR Nadelhalter	304	Mikro-Knüppel-pinzette	95-96	NABATOFF Olive	227
MAYO-HEGAR Nadelhalter	307	MIKRO-Laryngeal Faßzange	841	NABATOFF Zugseil, flexibles rostfrei	227
MAYO-NOBLE Schere	27	MIKRO-Löffel für Hypophysektomie	564	Nadeldose	292-294
MAYO-ROBSON ATRAUMA Darmklemme	617	MIKRO-Nadelhalter	296-300	NAEGELE Geburtszange	697
MAYO-ROBSON Darmklemme	609	MIKRO-Nasenschere	774	Nagelfeile	855
MAYO-STILLE Schere	26	MIKRO-Ohrhäkchen	736,737	Nagelhautzange	855
MC DONALD Elevator	426	MIKRO-Ohrzängchen	728-730	Nagelschere	853
MC GEE MIKRO-Ohrhäkchen	736	Mikro-Ohrzängchen WULLSTEIN	728	Nagelzange	854,855
MC GEE MIKRO-Ohrzängchen	732	MIKRO-Ohrzängchen, Löffel-förmig	730	NAGER Tonsillenhaken	833
MC GIVNEY Fasszange	628	MIKRO-Pinzette	92		
		MIKRO-Schere	16-19		

Nasenhaken	797
Nasenschere	774
NEFF Meniskusmesser	437
NEGUS Bruststütze	810
NEGUS Tonsillen Klemme	133
NEIVERT Nadelhalter	302
NEIVERT Nasenflügelhaken	800
NEIVERT-ANDERSON Osteotom	788
NELATON Hohlsonde	225
NELSON Faßpinzette	87
NELSON Trokar	230
Nerv-Präparierscheren	32
NEUMANN Schere	49
NEURO Stimmgabel	744
NICOLA MIKRO-Fasszange	601
NICOLA MIKRO-Schere	601
Nierenschale	876
NORFOLK AND NORWICH Wundspreizer	207
NORTHBENT Ligaturschere	52
NOTO Uteruspolypenzange	674
NOVAK Biopsiekürette	679
NOYES Iridektomiescheren	724
NUGENT Nahtpinzette	721
NUSSBAUM Magenklemme	612

O

O'CONNOR SULLIVAN Bauchdeckenhalter	218
O'CONNOR Wundhaken	154
O'BRIAN Schere	38
Ob Augennadeln	291
Oberarm-Manschette für Komprimeter	354
Oberschenkel-Manschette für Komprimeter	354
OBWEGESER Kiefer Ahle	826
OBWEGESER Kinnhalter	821
OBWEGESER Osteotom	823,824
OBWEGESER Progeniehalter	821
OBWEGESER Ramushaken	820
OBWEGESER Raspatorium	822,823
OBWEGESER Wundhaken	819
OCHSNER ATRAUMA Aortaklemme	517
OCHSNER Trokar	231
Og Augennadeln	291
Ohrspekulum, Einmalgebrauch	259
Ohrspekulum, wiederverwendbar	259
Ohrspritze	760
Ohrtrichter	259
OLDBERG Laminektomiezange	597
OLIVECRONA Drahtsäge	544
OLIVECRONA Dura-Dissektor	558
OLIVECRONA Schere	46
OLIVECRONA Spatel	553
OLIVECRONA-TOENNIS Clip- und Anlegezange	547
OLLIER Wundhaken	166
OLSEN-HEGAR Nadelhalter	308
OMBREDANNE Hammer	399
Operations-Laryngoskope mit Fieberglas-Lichtträger 280-284	259
Ophthalmoskop-Ersatzbirnchen	257
Ophthalmoskop-Besteck	257
Ophthalmoskop-Griff	259
Organfaßzange ATRAUMA	615
Osteotome	380,381-385,387-393
Osteotomeklänge auswechselbar	387
Oszillierende Gipssäge	350
OTIS Ersatzmesser für Urethrotom	643
OTIS Urethrotom	643
Otoskop-Bestek	256
Otoskop-Ersatzbirnchen	259
Otoskopkopf	259
OVERHOLT Ligatur Klemme	127
OVERHOLT-GEISSENDOERFER Klemme	127
OVERHOLT-MIXTER Klemme	125

P

PARKER Wundhaken	192
PARKER-LANGENBECK Wundhaken	193
PARKES Osteotom	790
PARTSCH Hammer	397
PARTSCH Meißel	380,381
PAYR Führungshohlsonde	335
PAYR Gefäßbündel	291
PAYR Magen-Darmquetschzange	613
PAYR-BABY Magen-Darmquetschzange	613
Pb Chirurgische Darmnadel	290
Pc Chirurgische Darmnadel	290
Pd Chirurgische Darmnadel	290
PEAN Arterienklemmen	113
PEAN Tuchklemme	146
PEAN-DEBAKEY ATRAUMA Klemme	494,495
PEAN-DELICATE Arterienklemmen	113
PEDERSON Spekulum	650
PEERS Tuchklemme	145
PEET Splitterzange	100
PELTESON Watteträger	229
PENFIELD Dura-Dissektor	557
PENNINGTON Elevator	782
PENNINGTON Klemmen	120
PERCY Amputationschild	355
PERCY Amputationsretraktor	355
Peritoneumklemme, Hysterektomieklammer ..	138,138
PERTHES Reibahle	356
PESTALOZZA Abortuslöffel	700
PHANEUF Hysterektomieklammer	138
PIERCE Antrum Trokar	231
PINARD Stethoskop, ALUMINIUM	250
PINARD Stethoskop, Holz	250
PIPER Geburtszange	697
PITHA Mundkeil	808
Plastik-Schutztasche für Trachealbesteck	847
Plazentabecken	877
PLESTER Lappenmesser	734
PLESTER Saugrohr	233,234
PLESTER Wundspreizer	200
POLITZER Einsteckkonus mit Deckplatte	758
POLITZER Luftdusche	758
POLITZER Trommelfellnadel	755
POLLOSON Wundhaken	183
POOLE Saugrohr	238
POPPE Saugrohr	233
POTTS ATRAUMA Gefäßklemme	496-498,512
POTTS DE MARTEL Gefäßschere	44
POTTS MIKRO-Schere	16
POTTS-GLOVER ATRAUMA Gefäßklemme	498
POTTS-SMITH Anatomische Pinzette	79
POTTS-SMITH Chirurgische Pinzette	84
POTTS-SMITH Gefäßschere	44
POZZI Hakenzange	670
Präparier- und Ligaturklemme	127-134
PRATT Cystikus Haken	626
PRATT Hakenzange	673
PRATT Klemme	121
PRATT Mastdarmspekulum	623
PRATT Uterus Dilator	667
PRESBYTERIAN Schlauchklemme	146
PRICE-THOMAS Bronchusklemme	486
PRINCE Schere	46
Probe- und Absaugkürette	693
PROVIDENCE-HOSPITAL Klemme	109
PUTTI Raspel	424

Q

QUERVIAN Elevator	426
QUINBY Schere	49
QUINKE Kanüle	241
QUIRE Ohrhebel	748

R

RABINER Hammer	249
RADOLF Nagelaußreißzange	469
RAGNELL Wundhaken	158
RAGNELL-DAVIS Wundhaken	158
RALK (VIRTUS) Splitterzange	100
RALK Handbohrapparat	359
RAMPLEY Schwammzange	149,151
RAMPLEY Schwammzange	151
RAMSEY Anatomische Pinzette	80
RAMSEY Chirurgische Pinzette	86
RANDALL Biopsiekürette	679
RANDALL Nierenstielklemme	629,630
RANEY Anlege- und Abnehmezange	548
RANEY Kopfhautklammer	548
RANKIN-DEBAKEY ATRAUMA Klemme	493
Rasierklingen, brechbar	14
Rasierklingenbrecher	14
Raspatorium	411-420
RAY Hypophysen Kürette	561
RECAMIER Kürette	687,688,689
Rectal Schere	42
REDON Nadeln	240
Reibahle	356
Reibahle mit T-Griff	356
REICHERT Deckenhalter	840
REIL MIKRO-Schere	19
REINER Gipsmesser	348
REINER Ohrspritze	759
Reinigungsbürste	847,881-885
Reinigungsbürsten	881-885
Repositionszange	443
RESANO ATRAUMA Rektum Klemme	621
RESANO Rektumschere	42
Retraktoren zur Fixation am OP-Tisch	551
Retraktoren zur Fixation am Schädel	549
REVERDIN Bauchspatel	195
REVERDIN Nadel	329
REYNOLDS Schere	39
RIBBON Bauchspatel	195
RICARD Bauchdeckenhalter	214
RICARD Mittelblatt	213
RICARD Seitenvalve	213
RICHARDSON Wundhaken	174
RICHARDSON-EASTMAN Wundhaken	174
RICHTER Wundspreizer	207
RICHTER-HEATH Zängchen	338
RIGBY Retraktor	208
Rippenschere	472
RITTER-HALLE Dilatationssonde	805
ROBB Gefäßdissektor	540
ROBERTS Klemme	125
ROBIN Tuchklemme mit Halter	145
ROBIN-MASSÉ Bauchdeckenhalter	214
ROBIN-MASSÉ Mittelvalve	213
ROCHARD Befestigungsgestell	222
ROCHARD Fixiervorrichtung	222
ROCHARD Rahmenhaken	222
ROCHESTER-CARMALT Klemme	122
ROCHESTER-PEAN Arterienklemme	114,115
RÖDER Binder / Tonsillenschnürer	835
ROEDER Tuchklemme	144
ROEDER Septum Elevator	783
ROGERS Hysterektomie ATRAUMA Klemme	142
ROGGE Sterilisierzange	862
ROLLET Augenhäkchen	709
Röntgen-Meßstab	255
ROSE Trachealhäkchen	844
ROSEN MIKRO-Ohraspatorium	738
ROSEN MIKRO-Rundschnittmesser	734
ROSEN Ohrnadel	735
ROSEN Ohrnadel	736
ROSENBERG Bronchosaufsatz	839
ROSER-KÖNIG Mundsperrer	809

ROSS Aorta Wundhaken 182
 ROUX Wundhaken 191
 ROWE Repositionszange 828
 RUBIN Osteotom 787
 RUBIN Septumzange 775
 RUDD Hämorrhoidal Ligator 627
 RUMEL Präpr./Ligatur Klemmen 128
 RUMEL-BELMONT Torniquet flexibel 541
 Runde Misch-Schale 869
 Runde Schale 869
 RUSKIN Hohlmeißelzange 457
 RUSKIN Knochensplitterzange 463
 RUSS.MODELL Chirurgische Pinzette 86
 RUST Amputationsäge 352
 RUST Ersatz-Sägeblatt 352
 RYDEL-SEIFFERT Stimmgabel 744

S

SAALFELD Komedonenquetscher 852
 SACHS Dura-Seperatoren 556
 SACHS Wundhaken 559
 SAENGER Abortuszange 698
 Sägeblatt für Oszillierende Gipsäge 350
 SALENIUS 437
 SAMII Tumorzange 94
 SANTULLI ATRAUMA Bulldogklemme 492
 SANVENERO Schere 36
 SAROT Klemme 126
 SATINSKY 487, 488
 SATINSKY ATRAUMA Klemme 506
 SATINSKY Gefäßklemme 488
 SATINSKY Gefäßschere 41
 SATTERLEE Amputationsäge 353
 SATTERLEE Sägeblatt 353
 SAUERBRUCH Abfallzange 886
 SAUERBRUCH Hohlmeißelzange 460
 SAUERBRUCH Sternumschere 472
 SAUERBRUCH Wundhaken 171, 178
 SAUERBRUCH Wundhaken 178
 Saugansatz 760
 SCALP-CONTOUR Wundsperrer 198
 Schädelhalter 545
 Schädelstanzen 546
 SCHAEDEL Tuchklemme 143
 SCHAMBERG Komedonenquetscher 852
 SCHEDE Scharfer Löffel 403
 SCHEIBE ATRAUMA Organfaßzange 615
 Scheidenspekula 648-662
 SCHEINMANN Bronchosaufsatz 839
 SCHERBACK Spekulum 660
 SCHERBAK Gewicht für Scheidenspekulum 660
 SCHERBAK Griff für Scheidenspekulum 660
 SCHERBAK Valve 660
 Schere 22-75
 SCHINK Dermatome 11
 SCHIOETZ Tonometer 704
 Schlauchklemme 146, 147
 Schlingen für Nasenpolypenschnürer 765
 Schlingen für Ohrpolypenschnürer 746
 SCHMEDEN Scharfe Nasenzange 769
 SCHMID Gefäßspülkanüle 242
 SCHMIEDEN Führungshohlsonde 335
 SCHMIEDEN Unterbindungsnadel 330
 SCHMIEDEN-DICK Unterbindungsnadel 330
 SCHMIEDEN-PAYR Führungshohlsonde 335
 SCHMIEDEN-TAYLOR Dura Schere 45
 SCHNIDT Klemme 124
 SCHNIDT Tonsillenzange 834
 SCHOENBORN Schilddrüsenhaken 845
 Schraubaufsatz für Tunnelier-Set 538
 Schraubenschlüssel für Tunnelier-Set 538
 Schraubolive 538
 SCHROEDER Hakenzange 671
 SCHROEDER Hakenzange 670
 SCHROEDER Uteruslöffel 686
 SCHUBERT Probeexzisionszangen 680
 SCHUKNECHT Rollenmesser 734
 SCHUKNECHT Saugkanüle 236
 SCHUKNECHT Sichelmesser 734
 SCHUKNECHT Wundspreizer 201
 SCHULTZE Salpingograph 694
 SCHULZE-BERGMANN Mastdarm Speku- 624
 SCHUMACHER Biopsie Aufsatz 685
 SCHUMACHER Bronchosaufsatz 839
 SCHUMACHER Nabelschnurschere 29
 SCHUMACHER Uterus Biopsiezange 682
 Schutzkappe für Septumzange RUBIN 775
 Schutzsteller 760
 Schwensschale 872
 SCOVILLE Haken 566, 567
 SCOVILLE Laminektomie-Spreizer 566
 SCOVILLE Nervwurzelhaken 554
 SCOVILLE Rahmen 566
 SCOVILLE Scharfer Löffel 405
 SCOVILLE Seitenvalve für Wundspreizer 566, 567
 SCOVILLE-HAVERFIELD Rahmen 566
 SCUDDER ATRAUMA Klemme 618
 SCUDDER Darm- und Magenklemme 610
 SEBILEAU Elevator 426
 SEDILLOT Raspatorium 416
 SEGOND Myommesser 2
 SEGOND-LANDAU Hysterektomie- 139
 Sehnen-Faßinstrument 440, 441
 Sehnen-Flechtklemme 441
 SEIFFERT Bronchosaufsatz 839
 SELLHEIM Geburtslöffel 698
 SEMB Bronchusklemme 486
 SEMB Hohlmeißelzange 457
 SEMB Knochenhalte- 446
 SEMB Knochensplitterzange 466
 SEMB Raspatorium 419
 SEMKEN Anatomische Pinzette 79
 SEMKEN Chirurgische Pinzette 83
 SEMM Bauchdeckenhalter 220
 SEMM Rahmen 220
 SEMM Rahmenhaken 220
 SEMM Scheidenspekulum 650
 Semptumzange 767
 SENN-MILLER Wundhaken 159
 Sequesterzange 444
 SERPENTINE IUP-Fasszange 685
 SEUTIN Verbandschere 347
 SEYFFERT Scheidenspekulum 650
 Seziermesser 3
 SHAAF Cilienpinzette 90
 SHAPLEIGH Ohrkürette 751
 SHEA MIKRO-Sondierhäkchen 737
 SHEEHAN Osteotom 789
 SIEBENMANN Kieferhöhlen-Spülkatheter 805
 SIEBOLD Schere 28
 Silikonmatte 866
 SILVER Dermatome 11
 SILVER Osteotom 790
 SIMON Fistelhaken 676
 SIMON Löffel 406
 SIMON Uteruslöffel 686
 SIMON Wundhaken 177
 SIMPLEX Wundsperrer 815
 SIMPSON Geburtszange 696
 SIMPSON-BRAUN Geburtszange 696
 SIMS Kürette 689, 690
 SIMS Mastdarmspekulum 622
 SIMS Schere 28
 SIMS Spekulum 652
 SIMS Uterus Sonde 668
 SIMS Vaginalsepekulum 652
 SIMS-MAIER Korn- und Tupferzange 149
 SINGLEY-TUTTLE Faßpinzette 87
 Skalpellgriffe 5, 6
 Skalpellklinge 7, 8
 Skalpellklingen-Abnehmer 8
 Skalpellklingen-Entfernungszange 8
 SKEENE Hakenzange 671
 SLUDDER-BALLENGER Aufsatz 836
 SLUDDER-BALLENGER Griff 836
 SLUDDER-BALLENGER Tonsillotom 836
 SMELLIE Perforatorium 700
 SMILLIE Meniskotom 436
 SMILLIE Meniskushaken 435
 SMITH-BUIE Anal Spreizer 624
 SMITH-PETERSON Hohlmeißel 383
 SMITH-PETERSON Osteotom 383
 SNELLEN Chalazionspinzette 721
 SOMER Uterusfaßzange 675
 Sonden 224
 Spannplatte, allein 11
 Spanschlüssel 350
 Spatel 553
 SPENCER Ligaturschere 52
 SPENCER-WELLS Arterienklemme 112
 Splitterpinzetten, Mikro-Pinzetten 89-91
 Splitterpinzetten, Mikro-Pinzetten mit Stift 89
 Splitterpinzetten, Mikro-Pinzetten ohne Stift 89
 Splitterzange 100
 SPRATT Scharfer Löffel 404
 Spülschale 870
 SPURLING Laminektomie- 594
 Sputumbecher mit Klappdeckel 875
 ST.CLAIR-THOMSON Ringmesser 804
 ST.MARKS Pelvishaken 189
 STACKE Sonde 224
 STAMMBERGER Antrumstanze 772
 Standard Trokar 230
 Ständer für 12 Ohrspekula 741
 Stanzylinder 872
 STAUDE-MOORE Hakenzange 669
 Stechbecken 876
 STEINMANN Nagel 373
 STEINMANN Sehnenfaßzange 440
 STELLBRINK Hohlmeißelzange 453
 STELZNER Gefäßschere 41
 Sterilisier-Korb 868
 Sterilisier-Siebschale 867
 Sterilisierzange 862
 STERNBERG Wangen- und Lippenhalter 815
 STEVENS Irispinzette 718
 STEVENS Schere 38
 STIEGLITZ Splitterzange 100
 STILLE Chirurgische Pinzette 82
 STILLE Gallensteinzange 635
 STILLE Gipschere 347
 STILLE Handbohrapparat 357
 STILLE Hohlmeißel 381
 STILLE Hohlmeißelzange 457
 STILLE Kugelfräser 357
 STILLE Meißel 381
 STILLE Nierenklemme 136
 STILLE Osteotom 381
 STILLE Spiralbohrer 357
 STILLE Trephine 357
 STILLE-BARRAYA Chirurgische Pinzette 85
 STILLE-LISTON Knochensplitterzange 464, 465
 STILLE-LUER Hohlmeißelzange 459, 460
 STILLE-RUSKIN Hohlmeißelzange 458
 Stimmgabel 742
 STOCKMANN Pennisklemme 645
 STONE Chirurgische Pinzette 83
 Stößel mit Ferrozellgriff 386
 Stößel mit Metallgriff 386
 Strabismus Schere 38
 STRANDELL-STILLE Wundhaken 161
 STRATTE Nadelhalter 307
 STRAUSS Penisklemme 645

STRULLY Schere	45
STRÜMPEL Ohrzängchen	749
STRUYCKEN Scharfe Nasenzangen	770
SUBRAMANIAN ATRAUMA Peripheral-Gefäßklemme	524
SUBRAMANIAN-MINIATUR ATRAUMA	524
SUPERCUT COTTLE Schere	70
SUPERCUT DIETHRICH Gefäßschere	71
SUPERCUT FOMON Schere	70
SUPERCUT FREEMANN-GORNEY Schere	75
SUPERCUT FREEMANN-KAYE Schere	75
SUPERCUT GOLDMANN-FOX Schere	73
SUPERCUT GORNEY Schere	74
SUPERCUT HEYMAN Schere	70
SUPERCUT Iris Schere	72
SUPERCUT JAMESON Präparierschere	74
SUPERCUT JOSEPH Schere	72
SUPERCUT KAYE FACE LIFT Schere	74
SUPERCUT KELLY Schere	72
SUPERCUT LEXER Schere	68
SUPERCUT LISTER Verbandschere	75
SUPERCUT MAYO Schere	66
SUPERCUT MAYO-STILLE Schere	66
SUPERCUT METZENBAUM Schere	67
SUPERCUT METZENBAUM-FINO Schere	68
SUPERCUT METZENBAUM-NELSON Schere	67
SUPERCUT PAR-TYPE Schere	74
SUPERCUT POTTS-SMITH Gefäßschere	71
SUPERCUT REYNOLDS Schere	73
SUPERCUT Schere	66-75
SUPERCUT SIEBOLD Schere	69
SUPERCUT SIMS Schere	69
SUPERCUT Standard Schere	66
SUPERCUT STEVENS Schere	73
SUPERCUT Strabismus Schere	68
SUPERCUT TOENNIS-ADSON Gefäßschere	69
SUPERCUT WAGNER Schere	72
SUPERCUT WALDMANN Episiotomie Schere	69
T	
TABB Schleimhautmesser	734
Tablettenschale	874
TAKAHASHI Siebbeinzange	769
TARNIER Kranioklast	701
TAYLOR Anatomische Pinzette	79
TAYLOR Chirurgische Pinzette	83
TAYLOR Hammer	248
TAYLOR Seitenvalve für Wundspreizer	567
TAYLOR Spinalhaken	434
TC-ADSON Anatomische Pinzette	97
TC-ADSON Chirurgische Pinzette	98
TC-ADSON MIKRO-Pinzette	97,98
TC-ADSON-BROWN Chirurgische Pinzette	98
TC-ARRUGA MIKRO-Nadelhalter	312
TC-BABCOCK Gewebefassklemme	606
TC-BABY-GILLIES Nadelhalter	324
TC-BARRAQUER Nadelhalter gebogen	314,315
TC-BARRY-STERNDAL Drahtspannzange	362
TC-BAUMGARTNER Nadelhalter	318
TC-BONNY Chirurgische Pinzette	99
TC-BOYNTON MIKRO-Nadelhalter	312
TC-BOZEMANN Nadelhalter	322
TC-BRUNS Schere	346
TC-CASTROVIEJO (JACOBSON) Nadelhalter	313,314
TC-CONVERSE Nadelhalter	317
TC-CORWIN-HEGAR Drahtspannzange	362
TC-CRILE Nadelhalter	327
TC-CRILE-WOOD BABY Nadelhalter	319
TC-CRILE-WOOD Nadelhalter	320
TC-CUSHING Anatomische Pinzette	97
TC-CUSHING-TAYLOR Anatomische Pinzette	97
TC-DEBAKEY Nadelhalter	320
TC-DEBAKEY Pinzette	99
TC-DEBAKEY Schere	60
TC-DERF Nadelhalter	316
TC-DIETHRICH Nadelhalter	316
TC-Drahtfaßzange	365
TC-Drahtkneifzange	366-368
TC-Drahtkneifzangen	367,368
TC-Drahtspannzange	362
TC-DUVAL Gewebefassklemme	607
TC-FERRIS-SMITH Chirurgische Pinzette	99
TC-FINOCCHIETTO Nadelhalter	323
TC-FOMON Nasenfeile	795
TC-GILLIES Chirurgische Pinzette	99
TC-GILLIES Nadelhalter	324
TC-GOLDMAN-FOX Schere	63
TC-HALSEY Nadelhalter	317
TC-HEGAR Nadelhalter starkes Modell	319
TC-HEGAR VASCULAR Nadelhalter	321
TC-HEPP-SCHIEDL Nadelhalter	316
TC-HÖSEL Nadelhalter	327
TC-HÖSEL Nadelhalter	328
TC-Iris Schere	62
TC-JOSEPH Schere	62
TC-KALT MIKRO-Nadelhalter	312
TC-KELLY Schere	62
TC-KILNER Nadelhalter	318
TC-LANGENBECK Nadelhalter	326
TC-LEXER Schere	56
TC-LICHTENBERG Nadelhalter	327
TC-LISTER Schere	342
TC-LOCKLIN Schere	63
TC-MASSON Nadelhalter	323
TC-MATHIEU Nadelhalter	325,326
TC-MATHIEU-KOCHER Nadelhalter	325
TC-MATHIEU-RYDER Nadelhalter	326
TC-MAY-HEGAR-SLENDER PATTERN Nadelhalter	319
TC-MAYO Schere	55
TC-MAYO-HARRINGTON Schere	61
TC-MAYO-HEGAR (HEANEY) Nadelhalter	319
TC-MAYO-HEGAR Nadelhalter	318
TC-MAYO-HEGAR-HEAVY PATTERN Nadelhalter	319
TC-MAYO-LEXER Schere	55
TC-MAYO-STILLE Schere	55
TC-MC INDOE Anatomische Pinzette	98
TC-METZENBAUM Schere	56,57
TC-METZENBAUM-FINO S Schere	58-59
TC-METZENBAUM-FINO Schere	57-58
TC-MILLER-COLLBURN Knochenfeile	423
TC-NEIVERT Nadelhalter	317
TC-OEHLER Chirurgische Pinzette	99
TC-OLSEN-HEGAR MINI Nadelhalter	324
TC-PARAMETRIUM Hysterektomieschere	61
TC-Pinzette	97-99
TC-POTTS-SMITH Anatomische Pinzette	98
TC-RAGNELL (KILNER) Schere	64
TC-RYDER MINI Nadelhalter	321
TC-RYDER-FRENCH EYE Nadelhalter	320
TC-SAROT Nadelhalter	322
TC-Schere	54-64
TC-SEMKEN Anatomische Pinzette	98
TC-SEMKEN Chirurgische Pinzette	99
TC-SENNING Nadelhalter	322
TC-SIMS Schere	61
TC-SLIM MIKRO-Nadelhalter	320
TC-STANDARD Anatomische Pinzette	97
TC-STANDARD Schere	54
TC-STRATTE Nadelhalter	323
TC-TOENNIS Nadelhalter	327
TC-TOENNIS-ADSON Schere	59
TC-Universal Schere	64
TC-WANGENSTEEN Nadelhalter	323
TC-WANGENSTEEN Pinzette	98
TC-WEBSTER Nadelhalter	317
TC-WERTHEIM Gynäkologie Schere	61
TC-YASARGIL Nadelhalter	315
TC-ZWEIFEL Nadelhalter	328
TEALE Hakenzange	671
TELESCOPE-Laryngoskopspatel	273
Terrier Arterienklemme	108
THOMS GAYLOR Probeexzisionszangen	681
THOMS-ALLIS Darmfaßklemme	605
THOREK Schere	34
TIECK-HALLE Nasenspekulum	763
TILLEY Ohrzängchen	748
TISCHLER-KEVORKIAN Biopsiezange	683
TISCHLER-MORGAN Biopsie Aufsatz	684
TISCHLER-MORGAN Biopsiezange	683
TITAN Bulldogklemme Arteria	103
TITAN Bulldogklemme Vena	102
TOBOLD Mundspatel	816
TOENNIS Arterienklemme	130
TOENNIS Dura-Dissektor	558
TOENNIS Duramesser	560
TOENNIS Gefäßschere	46
TOENNIS Nadelhalter	309
TOENNIS-ADSON Gefäßschere	46
TOHOKU Tuchklemme	145
Tonsillen-Drahtschlinge	835
TOWNSEND Biopsie Aufsatz	684
TOWNSEND Biopsiezange	684
TOWNSEND-MINI (BABY-TISCHLER) Biopsie Aufsatz	684
TOWNSEND-MINI (BABY-TISCHLER) Biopsiezange	684
TOYNBEE Ohrspekula	740
Tracheal-Besteck	847,848
TRELAT Vaginal Spekulum	651
TREVES Chirurgische Pinzette	86
TROELTSCH (WILDE) Ohr Pinzette	747
TROEMMER Hammer	248
TROLTSCH Nasentamponpinzette	766
TROUSSEAU Tracheal Dilatador	843
TROUTMAN (COLIBRI) Fixierpinzette	719
TROUTMANN-CHRIS Rasierklingenthaler	14
TUBBS Cardiovascular Dilatator	539
TUBERKULIN-LUER Spritze	246
Tuchklemme	143-145
TUFFIER Knochenhaltezange	447
TUFFIER Rippensperrer	479
TUFFIER Tumorfassklemme	120
Tunnelierschaft	538
TUOHY Kanüle zur Lumbalpunktion	242
TURNBULL Nagelzange	854
TURNER-WARWICK Gallensteinzange	634
TYDING Tonsillenschneider	836
U	
UCKERMANN Sonde	229
UECKERMANN Tracheal Trokar	843
ULRICH Knochenhaltezange	449,450
ULRICH Tupferzange	148
UNIVERSAL Ersatzflasche	806
UNIVERSAL Pulverbläser	757
UNIVERSAL Schere	50
UNIVERSAL Sterilisierzangen	862
UNIVERSAL Trokar	230
UNIVERSALGRIFF für Tunnelier-Set	538
UNNA Komedonenquetscher	852
UNNA-VIDAL Komedonenquetscher	852
Unterbindungsnadeln	329-334
URO-TANGENTIAL ATRAUMA Klemmen	136
USA MOD. Gippspreizer	349
USA MOD. Scharfer Löffel	406
V	
VALLEIX Uterus Sonde	668
VAN BUREN Harnröhrenbougie	641
VAN BUREN Sequesterzange	444
VAN DOREN Probeexzisionszangen	681
VANNAS Iridektomiescheren	725

Inhaltsverzeichnis
Alphabetical Index
Indice alfabético
Indice alfabético

VANNAS MOD.TÜBINGEN Iridektomiescheren 725
 VARADY Phlebotomiesektor 226
 VEIDENHEIMER ATRAUMA Klemme 620
 Ventilaufsatz allein 760
 Verbindungsschlauch 760
 VERBRUGGE Knochenhaltezange 452
 VERRÉS Insufflationskanüle 242
 Verschiedene Augenmesser 707
 VICKERS-EASYDRIVER Bohrhandgriff 373
 VIDAL Lupus Schaber 850
 VIGORIMETER Gummibälle, allein 252
 VIGORIMETER Kraftmesser 252
 VIRCHOW Knorpelmesser 3
 VIRCHOW Messer 4
 VISE MIKRO-Knüpppinzetten 96
 VOLKMANN Scharfer Löffel 402,403
 VOLKMANN Scharfer Löffel d/e 408
 VOLKMANN Wundhaken 162-164
 VOLLMAR Ringstripper 228
 Vorbohrer für Chutrchfield 545

W

WACHENFELDT Nahtpinzette 338
 WAGENER Ohrhäkchen 754
 WAGNER Knochenheber 430
 WAGNER Raspatorium 412,413
 WAGNER Scheren 39
 WALB Organmesser 4
 WALDMANN Episiotomie-Schere 29
 WALLICH Abortuslöffel 700
 WALTER Osteotom 787
 WALTER Osteotom 787
 WALTER-CARMALT Splitterpinzette 89
 WALTON Ersatzsägeblatt für Fingersäge 469
 WALTON Fingerringsäge 469
 WALTON Fremdkörperhohlmeißel 708
 Wangenhalter 815
 WANGENSTEEN Nadelhalter 306
 WARTENBERG Sensibilitäts-Instrument 250
 Waschschüssel 870
 WASSMUND Wundhaken 166
 WATSON-WILLIAMS Scharfe Nasenzange 769
 Wattedose mit Knopfdeckel 874
 WAUGH Chirurgische Pinzette 85
 WEBER ATRAUMA Klemme 505
 WEBER Drahtschlinge 712
 WEBER-LOCH Ohrschlinge 753
 WEBSTER Nadelhalter 301
 WEIL-BLAKELEY Nasenzange 770-772
 WEISSBARTH Vaginal Spekulum 661
 WEITLANER Wundsperrer 199
 WEITLANER-BABY 201
 WEITLANER-LOKTITE Wundsperrer 198
 WEITLANER-WULLSTEIN 200
 WELLS Chalazionlöffel 712
 WERTHEIM Hysterektomieklammer 138,139
 WERTHEIM Schere 27
 WERTHEIM-CULLEN Hysterektomieklammer 139
 WEST Flachmeißel 715
 WEST Hohlmeißel 715
 WESTCOTT Iridektomiescheren 724
 WESTCOTT MIKRO-Schere 17
 WESTMACOTT Nasentamponzange 766
 WHITE (COLVER) Tonsillenzange 834
 WHITE Tonsillenzange 834
 WHITEHEAD Mundsperrer 814
 WIEDER Zungendrücker 816
 WIEN Nasenspekulum 763
 WILDER Tränenkanal Dilator 716
 WILLET-MARTEL Kopfklemme 121
 WILLIAMS Darmfaßklemme 605
 WILLIGER Doppellöffel 409
 WILLIGER Hammer 395

WILLIGER Hammer 397
 WILLIGER Raspatorium 416,417
 WILLIGER Scharfe Löffel 407
 WILLIGER Septum Elevator 425
 WINTER Abortuszange 699
 WIRKSTROEM Klemmen 132
 WITTNER Uterus Biopsiezangen 682
 WOLFF Gipsabreißzange 349
 WOLFF Lupus Kürette 850
 WRIGLEY Geburtszange 696
 WULLSTEIN MIKRO-Ohrscheren 731
 WULLSTEIN MIKRO-Ohrzängchen 732
 WULLSTEIN MIKRO-Saugkanüle 235
 WULLSTEIN Ohr-Sichelmesser 734
 Wund- und Meniskushaken 434,435
 Wundhaken 154-194
 Wundhaken 155
 Wundnaht-Besteck in Metall-Etui 339
 Wundspreizer 196-217

Y

YANKAUER Saugrohr 238
 YASARGIL Fadenführer 563
 YASARGIL Fadengabel 562
 YASARGIL Galea Haken 548
 YASARGIL Hypophysenzange 597
 YASARGIL MIKRO-Fasszange 601
 YASARGIL MIKRO-Instrumente 562,563
 YASARGIL MIKRO-Messer 563
 YASARGIL MIKRO-Pinzetten 94
 YASARGIL Nadelhalter 358
 YASARGIL Saugrohr 237
 YASARGIL Scharfer Löffel 563
 YASARGIL Tumorpinzetten 93
 YASARGIL-SAMMII Tumorpinzetten 93
 YEOMAN Rektum Biopsiefasszange 627
 YOUNG Ersatznadel 330
 YOUNG Nahtinstrument 330
 YOUNG Prostatahaken 637
 YOUNG Zungenzange 818

Z

ZAUFAL Fremdkörperheber 753
 ZAUFAL-JANSEN Hohlmeißelzange 456
 ZENKER Klemmen 131
 ZENKER Wundhaken 172
 ZIEGLER Augenmesser 707
 ZIEGLER Stirnspiegel mit Stirnreif 260
 ZIELKE Hohlmeißel 390
 ZÖLLNER Ohrspekulum schwarz eloxiert 741
 ZÖLLNER Saugkanüle 236
 Zubehör LEYLA Retraktoren 550
 Zubehör LEYLA Retraktoren 553
 Zughaken für Extensionsbügel, groß 372
 Zughaken für Extensionsbügel, klein 372
 Zungendrücker 817

Inhaltsverzeichnis

Alphabetical Index

Indice alfabético

Indice alfabético

BRUNS Plaster scissors.....346
 BRUNS Sharp spoon..... 404,405
 Brush-disposal container860
 BRYANT Sponge and dressing forceps149
 BUCHWALD Tongue spatula.....817
 BUCK Ear curette 751,752
 BUCK Ear lever748
 BUCK Hammer249
 BUCK ligature scissors52
 BUCK-GRAMCKO Bone lever.....427
 BUCKLEY Retractor.....196
 BUIE Clamp121
 BULEAU Trocar231
 Bulldog clamp 101-152
 BUMENTHAL Gouge forceps.....455
 BUMM Uterus curette691
 BUNELL Hand drill359
 BUNNEL Tendon peeler438
 BUNNEL Tendon probe.....439
 BUNT Sterilizing clamp863
 BURFORD Rib spreader of ALUMINIUM477
 BURKE Biopsy forceps683
 BUSCH umbilical cord scissors29
 Button probe.....224

C

Caliper254
 Cap forceps with standing cylinder861
 CAPLAN Nasal scissors775
 CAROLL Finger goniometer253
 CAROLL Tendon-grasping instrument441
 CARPENTER Tonsil knife/dissector831
 CARREL Artery clamp108
 CASPAR Blade571
 CASPAR Dura-retractor560
 CASPAR Forceps570
 CASPAR Frame.....569-574
 CASPAR Laminectomy forceps.....595,596
 CASPAR Laminectomy retractor571
 CASPAR Laminectomy spreader, complete.....569-574
 CASPAR Lateral blade569,570,574
 CASPAR Retractor572
 CASPAR Retractor with Kungel
 quick-release fastener569,570
 CASPAR Speculum575
 CASPAR Wrench, single569
 CASTANEDA ATRAUMA Neonatal vascular clamp.....535
 CASTANEDA Rib spreader of ALUMINIUM478
 CASTROVIEJO Cannula714
 CASTROVIEJO Corneal scissors726
 CASTROVIEJO Double sliding instrument.....717
 CASTROVIEJO Eye compass.....715
 CASTROVIEJO Eye scissors.....723
 CASTROVIEJO Eyelid retractor.....704
 CASTROVIEJO Iridectomy scissors.....723,724
 CASTROVIEJO MICRO-needle holder.....298-300
 CASTROVIEJO razor blade breakers and holders14
 CASTROVIEJO spatula712
 CASTROVIEJO Suture forceps720
 CASTROVIEJO-BARRAQUER Spatula.....711
 CASTROVIEJO(JACOBSON) MICRO-needle holder299
 CATLIN amputation knife12
 CAWOOD-MINNESOTA Cheek and lip retractor.....815
 Cerclage wire.....369
 Chain, only for nursing set853
 CHAPUT Tumor-grasping clamp.....120
 Charging cone for haemorrhoidal ligator627
 Charging station for cold-light handle280
 CHARRIERE Amputation saw353
 CHARRIERE Replacement blade.....353
 CHEATTLE Sterilizing forceps862
 Cheek retractor815
 CHERON Sponge forceps149
 Chest support284

Chest support with laryngoscope mount284
 CHEVALIER-JACKSON Bronchoscope forceps.....838
 CHEVALIER-JACKSON Tracheal cannula.....846
 CHILDE Suture forceps337
 Cilia forceps.....91
 CINELLI osteotome788
 Circumcision instrument644
 CITELLI Antrum punch750, 837
 CITELLI Antrum punch777
 Clamp Instruments547
 Clamp instruments, galea retractor547
 Clamping wrench350
 CLAR Headlamp261,262
 Cleaning brush847,881-885
 Cleaning brushes.....881-885
 CLEVELAND Bone-splinter forceps.....462
 CLEVELAND Gouge forceps454
 Clip Set MINI-Assistant340
 CLOVER ATRAUMA Bulldog Clamp491,492
 CLOWARD Retractor210,211
 CLOWARD Vertebral spreader576
 COAKLEY Curette802
 COAKLEY Maxillary trocar232
 COBB Hollow reamer.....392
 COBB Raspator414
 COGSWELL Suction tube234
 Cold-light handle.....280
 COLIN amputation knife12
 COLLIER Needle holder301
 COLLIN Abdominal retractor212
 COLLIN Centre blade213
 COLLIN Dynamometer253
 COLLIN Grasping forceps120
 COLLIN Hammer.....396
 COLLIN Lateral blade213
 COLLIN Pelvimeter.....695
 COLLIN Retractor194
 COLLIN Sponge forceps149
 COLLIN Tongue forceps818
 COLLIN Umbilical cord clamp.....700
 COLLIN Uterus probe668
 COLLIN Uterus-grasping forceps675
 COLLIN Vaginal speculum649
 COLLIN Wound-clamp forceps338
 COLLIN-DUVAL tissue forceps.....87
 COLLIN-LOKTITE Retractor212
 COLLYER Pelvimeter.....695
 COMBINATION INSTRUMENT SET258
 COMCO Circumcision device.....644
 Compressorium, Fingernail drill468
 CONE Cranial surgery instrument546
 Connecting hose760
 CONVERSE Nostril retractor796,798
 CONVERSE Rhinoplasty knife778
 COOLEY ATRAUMA Anastomotic clamp525
 COOLEY ATRAUMA Carotid clamp525
 COOLEY ATRAUMA Catheter clamp.....529
 COOLEY ATRAUMA Iliaca clamp525
 COOLEY ATRAUMA Multi-purpose
 vascular clamp526,527,528
 COOLEY ATRAUMA Paediatric vascular clamp ...532-534
 COOLEY Retractor186
 COOLEY Rib spreader475
 COOLEY Suction tube239
 COOLEY Vascular dilator.....536,537
 COOLEY-BECK ATRAUMA Anastomotic clamps530
 COOLEY-DERRA ATRAUMA Anastomotic clamps.....530
 COOPER Ligature needle331
 CORDES Bronchoscope attachment839
 CORVILLOS Retractor178
 COTTLE Bridge retractor800
 COTTLE Cartilage crusher with grasping forceps791
 COTTLE Columella forceps801
 COTTLE Hammer.....397
 COTTLE Nasal file793

COTTLE Nasal retractor.....796
 COTTLE Nasal retractor.....800
 COTTLE Nasal speculum764
 COTTLE Osteotome786
 COTTLE Osteotome786,787
 COTTLE Periosteal elevator783
 COTTLE Raspator782
 COTTLE Rhinoplasty knife778
 COTTLE scissors.....47
 COTTLE Skin-grasping forceps801
 COTTLE-KAZANJIAN Bone-splinter forceps.....462
 COTTLE-NEIVERT Nasal retractor.....799
 COTTLE-WALSHAM Septum forceps801
 Cotton wool box with button lid.....874
 COUPLAND Attachment239
 COUPLAND Suction handle.....239
 Coupling piece.....693
 Cover with triangular recess.....872
 Cover, single872
 CRAWFORD Clamp.....126
 CRAWFORD scissors.....41
 CRAWFORD-SELLORS Clamp.....126
 CRAIG Nasal polyp forceps767
 Cranial holder545
 Cranial punch.....546
 Cranial surgery instruments544
 CRAWFORD Aorta retractor182
 CRILE Artery clamp110
 CRILE MURRAY Needle holder303
 CRILE Nerve hook.....540
 CRILE Retractor194
 CRILE WOOD Needle holder303
 CRILE-RANKIN Artery clamp.....111
 CRUTCHFIELD Cranial holder545
 CRYSTAL Holder653-657
 CRYSTAL Vaginal speculum653-657
 CUSCO Standard vaginal speculum649
 CUSCO Vaginal speculum648
 CUSHING anatomical forceps.....80
 CUSHING Drill358
 CUSHING Laminectomy forceps.....592
 CUSHING Nerve-root Hook555
 CUSHING Retractor.....159-161
 CUSHING Retractor.....559
 CUSHING surgical forceps.....84
 Cuticle nippers.....855
 CUZZI Abortion spoon699
 CZERNY Gallstone forceps634
 CZERNY Rectal speculum622
 CZERNY Retractor forceps674

D

D'ERRICO Drill358
 DAHLGREN Cranial surgery instrument546
 DAHLGREN Replacement blade546
 DAHMEN Hollow reamer393,394
 DAHMEN Osteotome393,394
 DALE ATRAUMA Peripheral vascular clamp.....519
 DANDY Clamp109
 DANDY Dura-separators.....556
 DANDY scissors45
 DARDIK ATRAUMA Vascular clamp.....522
 DARTIGUES Uterus-grasping forceps.....675
 DAVIDSON Retractor178
 DAVIS Dura-dissector.....558
 DAVIS Dura-dissector.....558
 DAVIS Spatula, flexible553
 DAVIS-BOYLE Mouth gag811
 DAY Ear retractor.....754
 DE BAKEY vascular scissors44
 DE LEE Obstetric forceps.....696
 DE MARTEL Insertion instrument544
 DE MARTEL-WOLFSON Anastomotic Clamp.....614
 DE MARTEL-WOLFSON Clamp holder.....614

DE MARTEL-WOLFSON Clamp-closing forceps.....	614
DE VILBISS Cranial surgery instrument.....	546
DE VILBISS Replacement blade.....	546
Dead-blow hammer with plastic handle.....	400
DEAN scissors.....	48
DEAVER Retractor.....	185-187
DEAVER scissors.....	25
DEBAKEY Atrauma aortic clamps.....	504
DEBAKEY Atrauma Bulldog clamp.....	490
DEBAKEY Atrauma forceps.....	489
DEBAKEY Atrauma vascular Clamp.....	498, 499, 501-503
DEBAKEY Atraumatic forceps.....	489
DEBAKEY Lateral blade.....	481,482
DEBAKEY Multi-purpose vascular clamps.....	513,514
DEBAKEY Paediatric vascular clamp.....	531
DEBAKEY Rib spreader.....	481,482
DEBAKEY Vascular dilator.....	537
DEBAKEY vascular scissors.....	44
DEBAKEY-DIETRICH Bulldog clamp.....	105
DEBAKEY-SATINSKY Atrauma Bulldog clamp.....	490
DEJERINE Hammer.....	248
DEMEL Wire-guide needle.....	370
DEMEL Wire-guide needle.....	370
DEMEL Wire-tightening forceps.....	369
DENHARDT Mouth gag.....	809
DENHARDT Silicone jaws.....	809
DENIS-BROWNE Abdominal retractor.....	220
DENIS-BROWNE Frame.....	220
DENIS-BROWNE Hook-on retractor.....	220
DENIS-BROWNE tissue forceps.....	87
DEPONETTE Stand-by box.....	864
DERF Needle holder.....	301
DERRA Atrauma Vascular clamp.....	516
DESCHAMPS Ligature needle.....	332,333
DESJARDIN's Gallstone forceps.....	635
DESJARDIN'S Gallstone spoon.....	635
DESJARDINS Gallstone probe.....	633
DESJARDINS Ligature clamp.....	133
DESMARRES Chalazion forceps.....	722
DESMARRES Eyelid retractor.....	705
DESMARRES Retractor.....	156
Diagnostic instrument set.....	258
DIAMOND Head cutter.....	366
DIEFFENBACH Bulldog clamp.....	106
DIETRICH Atrauma Aortic clamp.....	517
DIETRICH Bulldog clamp.....	105
DIETRICH vascular scissors.....	43
DIETRICH-HEGEMANN.....	43
DINGMANN Bone-holding forceps.....	442
DINGMANN Mouth gag.....	813
DINGMANN Tongue spatula.....	813
Disposable scalpels.....	9,10
Dissecting and ligating clamp.....	127-134
Dissecting knife.....	3
Dissectors, elevators.....	425,426
DIX Double sliding instrument.....	717
DIXON-LOVELACE Artery clamp.....	111
Double instrument, screw-on.....	717
DOUGLAS cilia forceps.....	90
DOUGLAS cilia forceps.....	91
DOUGLAS Trocar.....	231
DOYEN Abdominal retractor.....	176
DOYEN Atrauma Intestinal clamp.....	616
DOYEN Chain with weight.....	221
DOYEN Hammer.....	395
DOYEN Hollow probe.....	225
DOYEN Hook-on retractor.....	221
DOYEN Intestinal clamp.....	608
DOYEN Myoms instrument.....	676
DOYEN Raspatory.....	417,418
DOYEN scissors.....	27
DOYEN Speculum.....	659
DOYEN Uterus forceps.....	674
DOYEN Vaginal speculum.....	662
DOYEN-JANSEN (MOLT) Mouth gag.....	809
DOYEN-STILLE Retractor.....	175
Draw hook for extension bar, large.....	372
Draw hook for extension bar, small.....	372
Drill chuck with T-handle, complete.....	358
Drill-wire dispenser, multiple.....	377
Drill-wire Storage rack for wires.....	378
DUBOIS scissors.....	28
DUEHRSEN anatomical forceps.....	80
DUEHRSEN surgical forceps.....	85
DUPLAY Retractor forceps.....	671
DUPLEX Stethoscope.....	251
DUPUY-WEISS Tonsil needle.....	829
DURANTE surgical forceps.....	86
DUVAL Intestinal grasping clamp.....	607
DUVAL surgical forceps.....	87
E	
Ear funnels.....	259
Ear speculum, reusable.....	259
Ear speculum, single use.....	259
Ear syringe.....	760
EASTMAN Specula, large.....	651
EASTMAN Speculum.....	651
ECHLIN Gouge forceps.....	458
EICKEN-KILLIAN Nasal rinsing cannula.....	805
EISELSBERG thread scissors.....	52
ELÄSSER Renal-fistula forceps.....	631
ELLIOT Corneal trephine, complete in case.....	714
ELLIOT Handle.....	714
ELLIOT Trephine.....	714
ELSCHNIG Spatula.....	712
ENGL Plaster saw.....	348
ENGL. MODEL anatomical forceps.....	80
ENGL. MODEL Towel clamp.....	143
Enucleation scissors.....	34
Episiotomy scissors.....	29
EPPENDORFER Uterus biopsy forceps.....	682
ESMARCH Bandage scissors.....	346
ESMARCH Compression bandage.....	355
ESMARCH Plaster knife.....	348
EVES Tonsil snare.....	835
EXCENTRIC Bandage scissors.....	344
Extension bar.....	372
Eye needle.....	291
F	
FANSLER Rectoscope.....	626
FARABEUF Bone-holding forceps.....	446
FARABEUF Raspatory.....	416
FARABEUF Retractor.....	191
FARABEUF-LAMBOTTE Bone-holding forceps.....	446
FARRELL Cotton-wool applicator.....	229
FARRELL Phlebotomizer.....	229
FARRIOR Ear speculum.....	740
FAULKNER Curette.....	802
FAURE Peritoneal clamp.....	137
FAURE Probe-excision forceps.....	680
FAVALORO vascular scissors.....	45
FEHLAND Atrauma Rectal clamp.....	620
FEILCHENFELD splinter forceps.....	90
FEIN Cotton-wool applicator.....	229
FELDHEIM Band.....	468
FELDHEIM Finger Instrument.....	468
FERGUSON Bone-holding forceps.....	444
FERGUSON Clamp.....	121
FERGUSON Gallstone spoon.....	636
FERRIS-SMITH Laminectomy forceps.....	599
FERRIS-SMITH surgical forceps.....	85
FERRIS-SMITH-KERRISON Laminectomy punch.....	591
Ferrocil hammer.....	400
Ferrocil handle for replaceable chisel blade.....	387
FERROZELL Guide hollow probe.....	336
FIG. 3,4,5,7 cilia forceps.....	91
FILIFORM Sliding probe.....	641
Fine surgical scissors.....	40
Fine surgical scissors.....	36-40
Fingerring saw forceps.....	469
FINOCHIETTO.....	476
FINOCHIETTO (mod.) Rib spreader.....	480
FINOCHIETTO BABY Rib spreader.....	476,481
FINOCHIETTO Clamp.....	134
FINOCHIETTO INFANT Rib spreader.....	476
FINOCHIETTO Needle holder.....	306
FINOCHIETTO rectal scissors.....	42
FINSEN Retractor.....	196
FISCH Ear dissector.....	738
FISCHER Tendon peeler.....	439
FISCHER Tonsil knife.....	830
Fixing discs for drill wires.....	372
Flat chisel.....	380,381,384-385,387-392
Flat chisel blade.....	387
Flat chisel with Ferrocil handle.....	390,391
Flat forceps.....	363,364
FOERSTER Sponge forceps.....	150,151
FOMON dissecting scissors.....	34
FOMON Nasal file.....	794
FOMON Nasal rasp.....	795
FOMON Nasal retractor.....	797
Fomon Nasal scissors.....	47
FOMON Osteotome.....	788
FOMON Retractor.....	799
FOMON Rhinoplasty knife.....	778
FOREGGER Laryngoscope instrument set.....	271,277,278
Foreign body remover, standard.....	708
FORGE Guide hollow probe.....	335
FORGE-TAYLOR dura scissors.....	45
FOX Lupus curette.....	850
FRAENKEL Bronchoscope attachment.....	839
FRANZ Abdominal retractor.....	221
FRANZ Blade.....	221
FRANZ Frame.....	221
FRANZ Hook-on retractor.....	221
FRAZIER Dura-separators.....	556
FRAZIER Retractor.....	559
FRAZIER Suction tube.....	232
FREER Mucosa knife.....	779
FREER Mucosal retractor.....	799
FREER Septum chisel.....	784
FREER Septum elevator.....	781,782
FREER Septum knife.....	779
FRIEDMANN Gouge forceps.....	453
FRIEDMANN-VICKERS Gouge forceps.....	453
FRIEDMANN Retractor.....	176
FROSCH Bone-holding forceps.....	444
FRYKHOLM Gouge forceps.....	459
FULLER MICRO-Ear forceps.....	731
G	
GALLAHER Nasal rasp.....	793
GELLHORN Probe-excision forceps.....	680
GELPI Retractor.....	209
GELPI-LOKTITE Retractor.....	209
GEMINI Dissecting and ligating clamp.....	129
GERALD anatomical forceps.....	80
GERALD surgical forceps.....	84
GERSTER Bone-holding Clamp.....	361
GERZOG Hammer.....	398
GIERTZ-STILLE Sternum scissors.....	472
GIGLI Handle for wire saw.....	544
GIGLI Wire saw.....	544
GIL-VERNET Type Retractor.....	161
GILLIES Needle holder.....	308
GILLIES Skin retractor.....	851
GILLIES surgical forceps.....	83

Inhaltsverzeichnis

Alphabetical Index

Indice alfabético

Indice alfabetico



GLOVER ATRAUMA Bulldog clamp	491,498
GLOVER ATRAUMA Vascular clamp	515
GLUCK Rib scissors	472
GOELET Retractor	193
GOLDMANN-FOX scissors	49
GOLDSMITH (THUDICHUM) Nasal speculum	762
GOMEL MICRO-scissors	17
GOMEL Needle holder	297
GOOD vascular scissors	46
GOODELL Endospecula	678
GOSSET Abdominal retractor	215
GOSSET Centre blade	215
Gouge forceps	453-460
GRAEFE Hooks	154
GRAEFE Iris forceps	718
GRAEFE Star knife	706
GRAEFE Strabismus hook	710
GRAHAM Retractor	559
GRAVE Cystotome	708
GRAVE Iris retractor	708
GRAVE Speculum	650
GRAY Dissecting clamp	133
GREEN-ARMYTAGE Uterus clamp Forceps	698
GREGORY ATRAUMA Carotid clamp	492
GREGORY ATRAUMA Profunda clamp	518
GREGORY SOFT ATRAUMA Carotid clamp	492
GRONINGEN Nerve-root hook	555
GROSS Ear spoon and hook	752
GROSS Towel clamp	146
GROSS-MAIER Dressing forceps	148
GUEDEL-NEGUS Laryngoscope instrument set	269
Guide hollow probe	334
Guide hollow probe, Ferrocell	337
GUILLEN Suction raspatory	805
GUTHRIE Double fixing hook	709
GUTHRIE Hooks	154
GUYON ATRAUMA Renal pedicle clamp	134
GUYON Catheter	644
GUYON Clamp	134
GUYON Urethral bougie	641
Gynaecological scissors with tungsten carbide blades	61

H

HABERERER Abdominal spatula	195
HACKSTOCK Flat-nasal forceps	363
HAIGHT Rib spreader	479
HAIJEK Hammer	398
HAIJEK Sphenoid bone punch	776
HAIJEK-KOFLEK Sphenoid bone punch	776
HALL Dura-knife	560
HALL Septum elevator	781
HALLE Sharp spoon	407
HALSEY Needle holder	302
HALSEY Needle holder	302
HALSTEAD-MOSQUITO Clamp	106,107
Hammer	393-401
Hammer with plastic handle	400
Handle for biopsy forceps	684
Handle for ring stripper	228
HANK Uterus dilator	666
HARDY Enucleator	562
HARDY Implantation fork	562
HARDY Pituitary MICRO-curette	561
HARKEN	488
HARKEN ATRAUMA Aortic clamp	507
HARKEN Vascular clamp	488
HARMS Trabecular probe	716
HARRINGTON Retractor	184
HARTMANN Artery clamp	108
HARTMANN Ear catheter	746
HARTMANN Ear forceps	748,749
HARTMANN Ear forceps	753
HARTMANN Ear speculum	740

HARTMANN Ear spoon forceps	749
HARTMANN Gouge forceps	454
HARTMANN Nasal speculum	763
HARTMANN Nasal tampon forceps	766
HARTMANN Sharp nasal forceps	769
HARTMANN Tongue depressor	816
HARTMANN Tonsil forceps	837
HARTMANN Tuning fork	742-744
HARTMANN-HALLE Nasal speculum	762
HARTMANN-HOFFMANN Ear spoon forceps	749
HARTMANN-WULLSTEIN Ear forceps	749
HARY-FAHLBUSCH Enucleator	562
HAYES ATRAUMA Clamp	619
HEANEY Clamp	140
HEANEY Needle holder	305
HEANEY-BALLENTINE Hysterectomy clamp	140
HEANEY-KANTER Hysterectomy clamp	141
HEANEY-REZEK Hysterectomy clamp	140
HEATH Hammer	399
HEATH ligature scissors	52
HEBRA Chalazion spoon	713
HEGAR Needle holder	307
HEGAR Uterine dilator	663-665
HEGENBARTH Suture forceps	338
HEIFETZ Spatula	553
HEIFETZ tumor forceps	93
HEIMING Kidney-stone forceps	630
HEISS Clamp	123
HEISTER Mouth gag	809
HEMINGWAY Double curette	409,410
HENKE Tonsil dissector	832
HENLEY Centre blade	202
HENLEY Retractor	202
HENNIG Plaster spreader	349
HEPP-CUTTERS MICRO-scissors	17,19
HERRICK Renal pedicle clamp	136
HESS Bulldog clamp	106
HEYMANN scissors	47
HEYMANN Sharp nasal forceps	767
HEYWOOD-SMITH Polyp-grasping forceps	628
HIBBS Chisel	385
HIBBS Hollow reamer	385
HIBBS Osteotome	384,385
HIRSCHMANN Rectoscope	625
HOFF Towel clamps	145
HOFFMANN Hose clamp	863
HOHMANN Bone lever	428-431
HOHMANN-ALDINGER	431
HOKE Chisel	384
Holding plate for tunnelling attachments	538
HOLINGER Surgical laryngoscope	281
Hollow probe	224,225
Hollow probe with button	225
Hollow reamer	380,381,383-385,387-394
Hollow reamer blade, replaceable	387
HOLSHER Nerve-root hook	554
HOLTH Capsule punch	715
HOLZ Mouth spatula	817
HOLZHEIMER Retractor	197
HOPKINS Plaster knife	348
HORSLEY Dura-separators	556
Hose clamp	146,147
HÖSEL Retractor	175
HOUSE Curette	739
HOUSE MICRO-Measuring probe	738
HOUSE Suction cannula	236
HOUSE-DIETER Ear forceps	732,731
HUBER Universal Handle	838
HUDSON Drilling apparatus	358
HUDSON Milling cutter	358
HUMBY dermatome	11
HUMBY dermatome replacement blade	11
HUNT tumor forceps	94
HUNTER splinter forceps	89
HURD Tonsil dissector	831

HURD Tonsil needle	829
HUSFELDT ATRAUMA Peripheral vascular Clamp	521
Hysterectomy clamp	138-142

I

Incision scissors	25
INGE Vertebral spreader	576
Inner box, lid and base	294
Instrument case	873
Instrument cases	873
Instrument spray	880
Instrument tray	871
Intimate spatula	539
IOWA Bladder forceps	672
IOWA Cannula	240
Iris scissors	37
ISRAEL Retractor	167
ITERSON Tracheal retractor	844
IUD-grasping forceps	685
IVES-FANSLER Plastic obturator	625
IVES-FANSLER Rectoscope	625

J

JACKSON Surgical laryngoscope	281
JACKSON Tracheal retractor	844,845
JACKSON Vaginal speculum	651
JACOBS Retractor forceps	672
JACOBSON Double probe	562
JACOBSON MICRO-scissors	16
JAEGER Eyelid plate	705
JAEGER-GRIESHABER Lance knife	706
JAMESON Caliper with graduation	254
JAMESON dissecting scissors	39
JAMISON Needle holder	305
JANET Cylinder	246
JANET Wound and bladder syringe	246
JANSEN (GRUENWALD) Nasal tampon forceps	766
JANSEN Ear curette	752
JANSEN Gouge forceps	454,456
JANSEN Gouge forceps	456
JANSEN Retractor	197
JARCHO Retractor forceps	669
JAVID ATRAUMA Carotid-shunt clamp	523
JENNINGS Mouth gag	814
JOBSON-HORNE Cotton-wool applicator	229
JOHNS-HOPKINS Bulldog clamp	106
JOHNS-HOPKINS Clamp	125
JOHNSON Needle holder	306
JOLL (FRIEDMAN) Retractor	208
JOLL (PEOPLE) Retractor	208
JONES Towel clamp	143
JOSEPH Mucosal retractor	799
JOSEPH Nasal file	792
JOSEPH Raspator	783
JOSEPH Rhinoplasty knife	778
JOSEPH Rhinoplasty knife	778
JOSEPH Saw	791
JOSEPH scissors	35
JOSEPH Septum elevator	781
JOSEPH-MASING Septum elevator	783
JUDD-ALLIS Intestinal grasping clamp	605
JUDD-MASSON Bladder retractor	639
JUDD-MASSON Centre blade	639
JURASZ Laryngeal polyp forceps	840

K

KABERSKE Ear cannula	757
KABERSKE Powder blower, complete	757
KABERSKE Replacement bottle	757

KABIERSKE Valve ball	757	KOCHER-OCHSNER Artery clamps	117,118	LEMPERT Suction tube	233
KADER Spatula	190	KOERTE Retractor	166	LERCHE surgical forceps	83
KALLMORGEN Holder	658	KOGAN Endospecula	677	LERICHE Clamp	109
KALLMORGEN Speculum	658	KÖLNER Clip	548	LESTER Grasping forceps	720
KALT Needle holder	295	KÖNIG Guide hollow probe	334,335	LEWIN Bone-holding forceps	443
KALT Vascular needle	291	KÖNIG Tuning fork	745	LEWIS nasal rasp	794
KANE Umbilical cord clamp	700	KOOS MICRO-instrument	563	LEXER Hollow reamer	389,390
KANTROWITZ Ligature clamp	132	KRAUS MICRO-instrument	563	LEXER Osteotome	389
KATSCH Comedone squeezer	852	KRAUSE Bronchoscope attachment	839	LEXER scissors	32
KATZIN-BARRAQUER Eye scissors	723	KRAUSE Ear polyp snare	746	LEXER Spongiosa osteotome	388
KAYE Skin retractor	851	KRAUSE Nasal polyp snare	765	LEXER-BABY scissors	32
KEITH Surgical intestinal needle	290	KRAUSE Trocar	231	LEXER-FINO scissors	33
KELLY Artery clamp	110	KRAUSE-VOSS Ear polyp snare	746	LEYLA Ball-joint clamp	551,552
KELLY Ligature clamp	130	KRAUSE-VOSS Nasal polyp snare	765	LEYLA Clamping arm, flexible	549
KELLY Proctoscope	626	KRAYENBÜHL Dura-retractor	560	LEYLA Coupling head	551,552
KELLY Retractor	174,189	KRESSNER Septum forceps	801	LEYLA Fixing device	549
KELLY scissors	48	KROENLEIN Artery clamp	109	LEYLA fixing device 1(Clamp, 2Clamping arms)	550
KELLY Uterus-grasping forceps	674	KRONECKER Needle	331	LEYLA Holding arm for fixation	551,552
KELLY-RANKIN Artery clamp	110	KUEMMEL Spatula	190	LEYLA Retractor, complete set	551
KELSEY-FRY Maxillary awl	827			LEYLA Self-retaining spatula	549,551
KERN Bone-holding forceps	445,446			LEYLA Set, complete	549
KERRISON Antrum punch	777			LEYLA Spatula holder	549
KERRISON Laminectomy punch, non-collapsible	577-598			LEYLA Spatula holder	550
KEVORKIAN Biopsy attachment	684	L		LICHTENBERG Needle holder	309
KEVORKIAN Biopsy curette	679	LA FORCE Ring cutter	804	LICHTWITZ Trocar	231
KEVORKIAN Uterus biopsy forceps	682	LA GRANGE scissors	49	Lid for kidney dish	876
KEVORKIAN-PACIFIC Biopsy forceps	683	LABORDE Tracheal dilator	843	Lid for waste bin	886
KEYES Handle	851	LAHEY Clamp	134	Lid with knob for bedpan	876
KEYES Punch	851	LAHEY Goitre-grasping forceps	849	Ligature needles	329-334
KEYES Trephine set, complete on plate	851	LAHEY Retractor	169	Limiting plates with slot	372
Kidney dish	876	LAMBERT Chalazion forceps	722	LISTER (Sinusoidal) Sponge and dressing forceps	149
KIELLAND Obstetric forceps	697	LAMBERT-KAY ATRAUMA Aortic clamp	509	LISTER Bandage scissors	342-344
KILLIAN Elevator	782	LAMBOTTE Bone-holding forceps	447	LISTON amputation knife	12
KILLIAN Nasal speculum	764	LAMBOTTE Osteotome	382	LISTON Bone-splinter forceps	461
KILLIAN Nasal tampon forceps	767	LAMBOTTE Raspatory	418	LISTON-KEY Bone-splinter forceps	466
KILLIAN Septum gouge	785	LANDAU Trocar	232	LITTAUER cilia forceps	90
KILLIAN Septum gouge	785	LANDAU Vaginal speculum	662	LITTAUER Ear forceps	748
KILNER Nasal aspirators	234	LANDOLT Dissecting suction cups	234	LITTAUER ligature scissors	52
KILNER Nostril retractor	798	LANDOLT scissors	35	LITTLE Retractor	169
KILNER scissors	35	LANDOLT Tumor-grasping forceps	597	LITTLEWOOD Intestinal and tissue-grasping forceps	606
KILNER Skin retractor	850	LANDOLT-CUSHING Hypophysectomy speculum	561	LLOYD-DAVIS vascular scissors	41
KILNER-DOUGHTY Mouth gag	810	LANE Abdominal twin clamp	611	LOCKHARD-MUMMERY Hollow probe	225,226
KIRK Hammer	398	LANE Bone-holding forceps	448	LOCKLIN scissors	48
KIRK Hammer	400	LANE surgical forceps	85	LOCKWOOD-ALLIS Intestinal grasping clamp	605
KIRSCHNER Abdominal retractor	218,219	LANE Towel clamp	144	LOGAN Retractor	196
KIRSCHNER Drill wires	375,376	LANGE Bronchoscope attachment	839	LONG Nostril retractor	796
KIRSCHNER Extension bar	371	LANGE-HOHMANN Bone lever	430,431	Loops for ear polyp snare	746
KIRSCHNER Ferrozell guide hollow probe	336	LANGENBECK amputation knife	13	Loops for nasal polyp snare	765
KIRSCHNER Frame	218	LANGENBECK Bone-holding forceps	444,445	LORENZ Bandage scissors	345
KIRSCHNER Guide hollow probe	334	LANGENBECK Ear curette	751	LORNA Towel clamp	144
KIRSCHNER Hook-on retractor	219	LANGENBECK Elevator	424,426	LOUTE Wire tensioner	369
KIRSCHNER-BALLFOUR Hook-on retractor	219	LANGENBECK Elevator	426	LOVE Nerve-root hook	554
KIRSTEIN Nasal scissors	47	LANGENBECK Finger guards	808	LOVE-GRUENWALD Laminectomy forceps	593
KLEINERT-KUTZ Tendon-grasping forceps	441	LANGENBECK Raspatory	415	LOVE-KERRISON Laminectomy punch	582
KLIMA-ROSSEGGER Cannula	243	LANGENBECK Retractor	167,168,196	LOVELACE Lung-grasping forceps	487
KLINGENBERG-LOTH vascular scissors	41	LANGENBECK Saw	353	LOVELACE Lung-grasping forceps	487
KNAPP Eye hook	709	LANGENBECK-GREEN Retractor	158	LOWER Clamp	134
KNAPP Eye knife	706	Laryngeal mirror	842	LOWMAN Bone-holding Clamp	360
KNAPP Retractor	156	Laryngeal mirror handle	842	LOWMAN-HOGLUND Bone-holding Clamp	361
KNAPP-ROLLET Hook	709	Laryngoscope replacement lamp	272	LOWMAN-LAMBERT Bone-holding Clamp	361
KNIGHT Sharp nasal forceps	767	Lateral Vaginal speculum	678	LUBET-BARBON Nasal tampon forceps	766
KNOWLES Bandage scissors	344	LAWRENCE Dissecting and Ligating Clamp	132	LUC Sharp nasal forceps	768
KNUTSON Urethrographic Instrument	644	LAZAR MICRO-knotting forceps	96	LUCAE Ear retractor	754
KNUTSON-KOCH Cannula	644	Lead hand for adults	467	LUCAE Ear drum needle	755
KOCHER Artery clamps	116	Lead hand for children	467	LUCAE Forceps	747
KOCHER ATRAUMA Intestinal clamp	617	LEBSCHKE Sternum chisel	474	LUCAE Hammer	396
KOCHER Bladder retractor	640	LEES ATRAUMA Aortic clamp	508	LUCAE Tuning fork	744
KOCHER Goitre probe	849	LEGUE Bladder retractor	640	LUER Gouge forceps	455
KOCHER Intestinal clamp	609	LEGUE Bladder spreader	640	LUER Insulin syringe	245
KOCHER Retractor	164,165	LEGUE Centre blade	640	LUER LOCK Cannula	714
KOCHER Retractor	172	LEGUE Lateral blades	640	LUER Polyp-grasping forceps	628
KOCHER Retractor	173	LEKSELL-SILENT Gouge forceps	458	LUER Retractor	194
KOCHER Retractor	176	LELAND-JONES ATRAUMA Clamp	500	LUER Screw adapter	538
KOCHER-DELICATE Artery clamps	116	LEMPERT Ear spoon	756	LUER Tracheal cannula	846
KOCHER-LANGENBECK Retractor	170	LEMPERT Elevator	756	LUER Tracheal retractor	844

Inhaltsverzeichnis

Alphabetical Index

Indice alfabético

Indice alfabetico

LUER-KOERTE Gallstone spoon 635
 LUER-LOCK Intermediate piece 244
 LUER-LOCK Three-way valve 244
 LUER-LOCK Wound and bladder syringe 246
 LUKENS Thymus retractor 845
 LUNIATSCHKE Gauze packer 833

M

MAGILL Catheter forceps 266
 MAGILL Suction tube 235
 MANGOT Hysterectomy clamp 141
 MALTZ Nasal Rasp 792
 Manometer with rubber ball 265
 MARKWALDER Bone-splinter forceps 462
 MARQUARDT Gouge forceps 457
 MARTEL Clamp 121
 MARTIN ATRAUMA Peripheral vascular Clamp 520
 MARTIN Bone-holding Forceps 442
 MARTIN Brush dispenser 858
 MARTIN Fingerring saw 469
 MARTIN Pelvimeter 695
 MARTIN Replcement blade for finger saw 469
 MARTIN Retractor 177
 MARTIN Tunnelling set 538
 MARTIN Uterus probe 668
 MARTIN-IDEAL Fingernail and toenail drill 468
 MARTIN-VICKERS Hand holder 467
 MARTINI double spoon 409
 MASING Aspirator 783
 MASS-GENERAL-HOSPITAL Needle holder 303
 MASSON Needle holder 305
 MASTIN Muscle clamp 849
 MATHIEU Foreign-body forceps 645
 MATHIEU Holder 659
 MATHIEU Needle holder 309
 MATHIEU Rectal speculum 624
 MATHIEU Retractor 193
 MATHIEU Specula 659
 MATHIEU-KOCHER Needle holder 309
 MATHIEU-RYDER Needle holder 309
 MATSON Rib raspatory 420
 MAUNDER Mouth wedge 808
 MAYFIELD Gouge forceps 456
 MAYO Gallstone spoon 636
 MAYO Probe 633
 MAYO scissors 25
 MAYO Sterilizing clamp 863
 MAYO-ADAMS Retractor 208
 MAYO-BLAKE Gallstone forceps 634
 MAYO-HARRINGTON scissors 26
 MAYO-HEGAR Needle holder 304
 MAYO-HEGAR Needle holder 307
 MAYO-NOBLE scissors 27
 MAYO-ROBSON ATRAUMA Intestinal clamp 617
 MAYO-ROBSON Intestinal clamp 609
 MAYO-STILLE scissors 26
 MC DONALD Elevator 426
 MC GEE MICRO-Ear forceps 732
 MC GEE MICRO-ear hook 736
 MC GIVNEY Grasping forceps 628
 MC GIVNEY Haemorrhoidal ligator 627
 MC INDOE anatomical forceps 79
 MC INDOE bone Bone-splinter forceps 463
 MC INTOSH Laryngoscope spatula 270,275,276
 MC IVOR Mouth gag 812
 MC IVOR Mouth gag frame 812
 MC IVOR Tongue spatula 812
 MC KENTY Septum elevator 781,782
 MC KENZIE Clamping block 547
 MC KENZIE Clips and applying forceps 547
 MC KENZIE Silver clamp 547
 MC KENZIE Twist drill 358
 MC QUIGG-MIXTER Clamp 134

MC INDOE vascular scissors 45
 MCLEAN-LUIKART Obstetric forceps 697
 MCLEAN-TUCKER Obstetric forceps 697
 MEAD Gouge forceps 454
 MEAD Hammer 397
 Measuring beaker 869
 Measuring rod 255
 Medicine cup 874
 MEEKER Dissecting and Ligating clamp 131
 MELLINGER Eyelid retractor 704
 MELLINGER-AXENFELD Retractor elevator 704
 MENGHINI Needle 241
 Meniscus knife 436,437
 MERCEDES Lateral blade 484
 MERCEDES Spreader 484
 MERCEDES Thoracic spreader 484
 Metal catheter for women 642
 Metal cathodes for men 642
 Metal container for tunnelling set 538
 Metal hammer 401
 Metal olive 760
 METHOT Cotton-wool dispenser 875
 METHOT Cotton-wool waste bin 875
 METZENBAUM baby scissors 30
 METZENBAUM Needle holder 303
 METZENBAUM scissors 30
 METZENBAUM-FINO S scissors 34
 METZENBAUM-FINO scissors 33,34
 METZENBAUM-NELSON scissors 31
 MEYER Foreign body gouge 708
 MEYERDING Retractor 157,185
 MEYERDING Retractor 185
 MEYHOEFER Chalazion spoon 713
 MICHEL Forceps 338
 MICHEL Laryngeal mirror 842
 MICHEL MOD. Forceps 338
 MICHEL Suture forceps 337
 MICHEL Wound clamps 339
 Micro-Adson anatomical forceps 78
 MICRO-ADSON Clamp 124
 MICRO-dissector for hypophysectomy 564
 MICRO-Ear forceps 728-730
 Micro-ear forceps WULLSTEIN 728
 MICRO-ear forceps, spoon shaped 730
 MICRO-Ear hook 736,737
 MICRO-Elevator 425
 MICRO-Eye Scissors 723
 MICRO-forceps 92
 MICRO-grasping forceps 600,601
 MICRO-grasping forceps for hypophysectomy 565
 MICRO-hook for hypophysectomy 564
 Micro-knotting forceps 95-96
 MICRO-Laryngeal grasping forceps 841
 MICRO-Nasal Scissors 774
 MICRO-Needle holder 296-300
 MICRO-Raspatory 564
 MICRO-scissors 16-19
 MICRO-spoon for hypophysectomy 564
 MICRO-Tonsil forceps 834
 MIDDELDRORPF Retractor 173,176
 MIDDELTON-JANSEN Septum forceps 775
 MIKULICZ 188
 MIKULICZ Hysterectomy clamp 139
 MIKULICZ Peritoneal clamp 137
 MIKULICZ Tonsil forceps 834
 MILLER Laryngoscope instrument set 267,268,274
 MILLER-BABY Laryngoscope instrument set 267
 MILLER-COLBURN Double curette 410
 MILLER-COLBURN Bone file 421,422
 MILLIGAN 201
 MILLIGAN Dura-separators 556
 MILLIN ATRAUMA Prostatectomy clamp 638
 MILLIN Bladder neck retractor 638
 MILLIN Bladder retractor 639
 MILLIN Centre blade 639

MILLIN Cold-light attachment for fibre optics 639
 MILLIN Frame, single 639
 MILLIN Lateral blade 639
 MILLIN Prostate clamp, T-shaped 638
 MILLIN Prostate clamp, Allis-shaped 638
 MILLIN Prostate clamp, T-shaped 638
 MILLIN Thread guide forceps, U-shaped 638
 MINI MCGEE Alligator ear forceps 729
 MINI-FRIEDMANN Gouge forceps 453
 MINI-GEMINI Dissecting and ligating clamp 128
 MINI-HOHMANN Bone lever 427
 MINI-LAMBOTTE Chisel 382
 MINI-LANGENBECK Retractor 156
 MINI-LEXER Chisel 388
 MINI-LEXER Hollow reamer 388
 MINI-ROUX retractor 192
 MINI-TOWNSEND (BABY-TISCHLER) Biopsy forceps 684
 MINI-TOWNSEND (BABY-TISCHLER) Biopsy forceps attachment 684
 MINI-TOWNSEND Biopsy forceps 683
 MIXTER Clamp 132-134
 MIXTER Gallstone forceps 635
 MIXTER-CRAFOORD Ligature clamp 126
 MIXTER-O'SHAUGNESSY Clamp 132
 MOD. USA umbilical cord scissors 29
 Mod. WIEN Thread knotter 336
 MOELTGEN Protractor 253
 MOGEN Circumcision instrument 644
 MOHR Spring clip 763
 MOLDENHAUER Foreign body lever 753
 MOLLISON Retractor 200
 MOORE Gallstone spoon 636
 MORRIS Retractor 184
 MORRIS-DEBAKEY Aortic clamp 510
 MORSE Sternum retractor 483
 MORSE-FAVALORO Sternum retractor 483
 MOSQUITO-DANDY Artery clamp 109
 MOSQUITO-DEBAKEY ATRAUMA Clamp 493
 Mouth cup 875
 MOYNIHAN Gallstone probe and spoon 633
 MOYNIHAN Hysterectomy clamp 138
 MÜLLER-VERBRUGGE Bone lever 431
 Multi-purpose tray 871
 MURPHY-LANE Luxation lever 433
 MUSEUX Retractor forceps 672
 Myrtle leaf probe 224

N

NABATOFF Handle only 227
 NABATOFF Metal case 227
 NABATOFF Olive 227
 NABATOFF Plastic probe tip 227
 NABATOFF Pulling rope, flexible stainless steel 227
 NABATOFF Varicose vein instrument set 227
 NAEGELE Obstetric forceps 697
 NAGER Tonsil retractor 833
 Nail clippers 854,855
 Nail file 855
 Nail scissors 853
 Nasal retractor 797
 Nasal scissors 774
 Needle box 292-294
 NEFF Meniscus knife 437
 NEGUS Breast support 810
 NEGUS Tonsil clamp 133
 NEIVERT Needle holder 302
 NEIVERT Nostril retractor 800
 NEIVERT-ANDERSON Osteotome 788
 NELATON Hollow probe 225
 NELSON tissue forceps 87
 NELSON Trocar 230
 Nerve preparation scissors 32
 NEUMANN scissors 49
 NEURO Tuning fork 744

NICOLA MICRO-grasping forceps	601	PELTESON Cotton-wool applicator	229	RAMSEY surgical forceps	86
NICOLA MICRO-scissors	601	PENFIELD Dura-dissector	557	RANDALL Biopsy curette	679
NORFOLK AND NORWICH Retractor	207	PENNINGTON Clamps	120	RANDALL Renal pedicle clamp	629,630
NORTHBENT ligature scissors	52	PENNINGTON Elevator	782	RANEY Applying and amputation forceps	548
NOTO Uterus polyp forceps	674	PERCY Amputation retractor	355	RANEY Scalp clip	548
NOVAK Biopsy curette	679	PERCY Amputation shield	355	RANKIN-DEBAKEY ATRAUMA Clamp	493
NOYES Iridectomy scissors	724	Peritoneal clamp, hysterectomy clamp	138,138	Raspatory	411-420
NUGENT Suture forceps	721	PERTHES Reamer	356	RAY Pituitary curette	561
NUSSBAUM Abdominal clamp	612	PESTALOZZA Abortion spoon	700	Razor blade breaker	14
		PHANEUF Hysterectomy clamp	138	Razor blades, breakable	14
O		PIERCE Antrum Trocar	231	Reamer	356
O'BRIAN scissors	38	PINARD Stethoscope, ALUMINIUM	250	Reamer with T-handle	356
O'CONNOR Retractor	154	PINARD Stethoscope, wood	250	RECAMIER Curette	687,688,689
O'CONNOR SULLIVAN Abdominal retractor	218	PIPER Obstetric forceps	697	Rectal scissors	42
Ob eye needles	291	PITHA Mouth wedge	808	REDON Needles	240
OBWEGESER Chinrest	821	Pivoting bowl	872	Reduction forceps	443
OBWEGESER Mandibular protrusion holder	821	Placenta pan	877	REICHERT Suspension bracket	840
OBWEGESER Maxillary awl	826	Plastic mouth spatula	817	REIL MICRO-scissors	19
OBWEGESER Osteotome	823,824	Plastic protective bag for tracheal instruments	847	REINER Ear syringe	759
OBWEGESER Ramus hook	820	PLESTER Flap knife	734	REINER Plaster knife	348
OBWEGESER Raspatory	822,823	PLESTER Retractor	200	Replacement blade for LA FORCE ring cutter	804
OBWEGESER Retractor	819	PLESTER Suction tube	233,234	Replacement blade of FERROZELL	401
OCHSNER ATRAUMA Aortic clamp	517	POLITZER Air shower	758	Replacement lamp for cold-light laryngoscope	279
OCHSNER Trocar	231	POLITZER Eardrum needle	755	Replacement light carrier	285
Og eye needles	291	POLITZER Insertion cone with cover plate	758	Replacement saw blade	469
OLDBERG Laminectomy forceps	597	POLLOSON Retractor	183	Replacement textile special filter	865
OLIVECRONA Dura-dissector	558	POOLE Suction tube	238	Replacement mandrel	545
OLIVECRONA scissors	46	POPEN Suction tube	233	RESANO ATRAUMA Rectal Clamp	621
OLIVECRONA Spatula	553	POTTS ATRAUMA Vascular Clamp	496-498,512	RESANO rectal scissors	42
OLIVECRONA Wire saw	544	POTTS DE MARTEL vascular scissors	44	Retractor	154-194
OLIVECRONA-TOENNIS Clipping and applying forceps	547	POTTS MICRO-scissors	16	Retractor	196-217
OLLIER Retractor	166	POTTS-GLOVER ATRAUMA Vascular Clamp	498	Retractor	155
OLSEN-HEGAR Needle holder	308	POTTS-SMITH anatomical forceps	79	Retractor and meniscus retractor	434,435
OMBREDANE Hammer	399	POTTS-SMITH surgical forceps	84	Retractors for cranial fixation	549
ONCE Foreign body lever	753	POTTS-SMITH vascular scissors	44	Retractors for fixation on the operating table	551
Ophthalmoscope handle	259	POZZI Retractor forceps	670	REVERDIN Abdominal spatula	195
Ophthalmoscope instrument set	257	PRATT Clamp	121	REVERDIN Needle	329
Ophthalmoscope replacement bulb	259	PRATT Cystic hook	626	REVERSE Tongue depressor	816
Organ grasping forceps ATRAUMA	615	PRATT Rectal speculum	623	REYNOLDS scissors	39
Oscillating plaster saw	350	PRATT Retractor forceps	673	Rib scissors	472
Osteotome	380,381-385,387-393	PRATT Uterine dilator	667	RIBBON Abdominal spatula	195
Osteotome blade, replaceable	387	Pre-drill for Chritchfield	545	RICARD Abdominal retractor	214
OTIS Replacement blade for urethrotome	643	PRESBYTERIAN Hose clamp	146	RICARD Centre blade	213
OTIS Urethrotome	643	Pressure gauge	694	RICARD Lateral blade	213
Otoscope head	259	Pressure gauge for comprimeters	354	RICHARDSON Retractor	174
Otoscope instrument set	256	PRICE-THOMAS Bronchus clamp	486	RICHARDSON-EASTMAN Retractor	174
Otoscope replacement bulb	259	PRINCE scissors	46	RICHTER Retractor	207
OVERHOLT Ligature clamp	127	Probe and suction curette	693	RICHTER-HEATH Forceps	338
OVERHOLT-BEISSENDOERFER Clamp	127	Probes	224	RIGBY Retractor	208
OVERHOLT-MIXTER Clamp	125	Protective cap for septum forceps RUBIN	775	Rinsing bowl	870
		Protective plate	760	RITTER-HALLE Dilatation probe	805
P		PROVIDENCE-HOSPITAL Clamp	109	ROBB Vascular dissector	540
PARKER Retractor	192	Punching cylinder	872	ROBERTS Clamp	125
PARKER-LANGENBECK Retractor	193	PUTTI Rasp	424	ROBIN Towel clamp with holder	145
PARKES Osteotome	790			ROBIN-MASS Abdominal retractor	214
PARTSCH Chisel	380,381	Q		ROBIN-MASS Centre blade	213
PARTSCH Hammer	397	QUERVIAN Elevator	426	ROCHARD Fixing device	222
PAYR Gastrointestinal forceps	613	QUINBY scissors	49	ROCHARD Hook-on retractor	222
PAYR Guide hollow probe	335	QUINKE Cannula	241	ROCHARD Mounting frame	222
PAYR Vascular needle	291	QUIRE Ear lever	748	ROCHESTER-CARMALT Clamp	122
PAYR-BABY Gastrointestinal forceps	613			ROCHESTER-PEAN Artery clamp	114,115
Pb Surgical intestinal needle	290	R		RÖDER Binders/tonsil snare	835
Pc Surgical intestinal needle	290	RABINER Hammer	249	ROEDER Towel clamp	144
Pd Surgical intestinal needle	290	RADOLF Nail-pulling forceps	469	ROGER Septum elevator	783
PEAN Artery clamps	113	RAGNELL Retractor	158	ROGERS Hysterectomy ATRAUMA clamp	142
PEAN Towel clamp	146	RAGNELL-DAVIS Retractor	158	ROGGE Sterilizing forceps	862
PEAN-DEBAKEY ATRAUMA Clamp	494,495	RALK (VIRTUS) splinter forceps	100	ROLLET Eye hook	709
PEAN-DELICATE Artery clamps	113	RALK Hand drill	359	ROSE Tracheal retractor	844
PEDERSON Speculum	650	RAMPLEY Sponge forceps	149,151	ROSEN Ear needle	735
PEERS Towel clamp	145	RAMPLEY Sponge forceps	151	ROSEN Ear needle	736
PEET splinter forceps	100	RAMSEY anatomical forceps	80	ROSEN MICRO-Circular cutting knife	734
				ROSEN MICRO-Ear raspatory	738
				ROSENBERG Bronchoscope attachment	839
				ROSER-KÖNIG Mouth gag	809
				ROSS Aorta Retractor	182

Inhaltsverzeichnis

Alphabetical Index

Indice alfabético

Indice alfabetico



Round bowl	869
Round mixing bowl	869
ROUX Retractor	191
ROWE Reduction forceps	828
Rubber jaws for YOUNG tongue forceps	818
Rubber rings for haemorrhoidal ligator	627
RUBIN Osteotome	787
RUBIN Septum forceps	775
RUDD Hemorrhoidal ligator	627
RUMEL Dissecting/ligating clamps	128
RUMEL-BELMONT Tourniquet, flexible	541
RUSKIN Bone-splinter forceps	463
RUSKIN Gouge forceps	457
RUSS.MODEL surgical forceps	86
RUST Amputation saw	352
RUST Replacement saw blade	352
RYDEL-SEIFFERT Tuning fork	744

S

SAALFELD Comedone squeezer	852
SACHS Dura-separators	556
SACHS Retractor	559
SAENGER Abortion forceps	698
SALENIUS	437
SAMII tumor forceps	94
SANTULLI ATRAUMA Bulldog clamp	492
SANVENERO scissors	36
SAROT Clamp	126
SATINSKY	487, 488
SATINSKY ATRAUMA Clamp	506
SATINSKY Vascular clamp	488
SATINSKY vascular scissors	41
SATTERLEE Amputation saw	353
SATTERLEE Saw blade	353
SAUERBRUCH Gouge forceps	460
SAUERBRUCH Sternum scissors	472
SAUERBRUCH Waste tongs	886
SAURE BREAK Retractor	171,178
SAUREBRUCH Retractor	178
Saw blade for oscillating plaster saw	350
SCALP-CONTOUR Retractor	198
Scalpel blade	7,8
Scalpel blade collector	8
Scalpel blade removal forceps	8
Scalpel handles	5,6
SCHAEDEL Towel clamp	143
SCHAMBERG Comedone squeezer	852
SCHEDÉ Sharp spoon	403
SCHÉIBE ATRAUMA Organ-grasping forceps	615
SCHHEINMANN Bronchoscope attachment	839
SCHERBACK Speculum	660
SCHERBAK Blade	660
SCHERBAK Handle for vaginal speculum	660
SCHERBAK Weight for vaginal speculum	660
SCHIOETZ Tonometer	704
SCHMEDEN Sharp nasal forceps	769
SCHMID Vascular-irrigation cannula	242
SCHMIEDEN Ligature needle	330
SCHMIEDEN-DICK Ligature needle	330
SCHMIEDEN-PAYR Guide hollow probe	335
SCHNIDT Clamp	124
SCHNIDT Tonsil forceps	834
SCHOENBORN Thyroid retractor	845
SCHRÖDER Retractor forceps	671
SCHROEDER Retractor forceps	670
SCHROEDER Uterus spoon	686
SCHUBERT Probe-excision forceps	680
SCHUKNECHT Retractor	201
SCHUKNECHT Roller knife	734
SCHUKNECHT Sickle knife	734
SCHUKNECHT Suction cannula	236
SCHULTZE Salpingograph	694
SCHULZE-BERGMANN Rectal specula	624
SCHUMACHER Biopsy attachment	685
SCHUMACHER Bronchoscope attachment	839
SCHUMACHER umbilical cord scissors	29
SCHUMACHER Uterus biopsy forceps	682
Scissors	22-75
SCOVILLE Frame	566
SCOVILLE Laminectomy spreader	566
SCOVILLE Lateral blade for retractor	566,567
SCOVILLE Nerve-root hook	554
SCOVILLE Retractor	566,567
SCOVILLE Sharp spoon	405
SCOVILLE-HAVERFIELD Frame	566
Sealing ring	538
Screw olive	538
SCUDDER ATRAUMA Clamp	618
SCUDDER Intestinal and abdominal clamp	610
Sealing ring	693
SEBILEAU Elevator	426
SEDILOT Raspatory	416
SEGOND myoma knife	2
SEGOND-LANDAU Hysterectomy clamp	139
SELLHEIM Obstetric spoon	698
SEMB Bone-holding forceps	446
SEMB Bone-splinter forceps	466
SEMB Bronchus clamp	486
SEMB Gouge forceps	457
SEMB Raspatory	419
SEMKEN anatomical forceps	79
SEMKEN surgical forceps	83
SEMM Abdominal retractor	220
SEMM Frame	220
SEMM Hook-on retractor	220
SEMM Vaginal speculum	650
Semptum forceps	767
SENN-MILLER Retractor	159
Sequester forceps	444
SERPENTINE IUD-grasping forceps	685
SEUTIN Bandage scissors	347
SEYFFERT Vaginal speculum	650
SHAAF cilia forceps	90
SHAPLEIGH Ear curette	751
SHEA MIKRO-probe hook	737
SHEEHAN Osteotome	789
SHINK dermatome	11
SIEBENMANN Maxillary sinus irrigation catheter	805
SIEBOLD scissors	28
SIFT Bronchoscope attachment	839
Silicone mat	866
SILVER dermatome	11
SILVER Osteotome	790
SIMON Fistula hook	676
SIMON Retractor	177
SIMON Spoon	406
SIMON Uterus spoon	686
SIMPLEX Mouth gag	815
SIMPSON Obstetric forceps	696
SIMPSON-BRAUN Obstetric forceps	696
SIMS Curette	689,690
SIMS Rectal speculum	622
SIMS scissors	28
SIMS Speculum	652
SIMS Uterus probe	668
SIMS Vaginal speculum	652
SIMS-MAIER Sponge and dressing forceps	149
Single clamping plate	11
Single replacement blade	11
SINGLEY-TUTTLE tissue forceps	87
SKEENE Retractor forceps	671
SLUDDER-BALLENGER Attachment	836
SLUDDER-BALLENGER Handle	836
SLUDDER-BALLENGER Tonsillotome	836
Small transformer for headlamp	262
SMELLIE Perforator	700
SMILLIE Menisotome	436
SMILLIE Meniscus retractor	435
SMITH-BUIE Anal spreader	624
SMITH-PETERSON Hollow reamer	383
SMITH-PETERSON Osteotome	383
SNELLEN Chalazion forceps	721
SOMER Uterus-grasping forceps	675
Spatula	553
SPENCER ligature scissors	52
SPENCER-WELLS Artery clamp	112
Splinter forceps	100
Splinter forceps, micro-forceps	89-91
Splinter forceps, micro-forceps with pin	89
Splinter forceps, micro-forceps without pin	89
Sponge and dressing forceps	148-151
SPRATT Sharp spoon	404
SPURLING Laminectomy forceps	594
Sputum cup with hinged lid	875
ST.CLAIR-THOMSON Ring cutter	804
ST.MARKS Pelvis retractor	189
STACK Probe	224
STAMMBERGER Antrum punch	772
Stand for 12 ear specula	741
Stand-by boxes	865
Standard Trocar	230
STAUBE-MOORE Retractor forceps	669
STEINMANN Nail	373
STEINMANN Tendon-grasping forceps	440
STELLBRINK Gouge forceps	453
STELZNER vascular scissors	41
Sterilizing basket	868
Sterilizing forceps	862
Sterilizing sieve tray	867
STERNBERG Cheek and lip retractor	815
STEVENS Iris forceps	718
STEVENS scissors	38
STIEGLITZ splinter forceps	100
STILLE Ballpoint burr	357
STILLE Chisel	381
STILLE Gallstone forceps	635
STILLE Gouge forceps	457
STILLE Hand drill	357
STILLE Hollow reamer	381
STILLE Osteotome	381
STILLE Plaster scissors	347
STILLE Renal clamp	136
STILLE surgical forceps	82
STILLE Trephines	357
STILLE Twist drills	357
STILLE-BARRAYA surgical forceps	85
STILLE-LISTON Bone-splinter forceps	464,465
STILLE-LUER Gouge forceps	459,460
STILLE-RUSKIN Gouge forceps	458
STOCKMANN Penis clamp	645
STONE surgical forceps	83
Strabismus scissors	38
STRANDELL-STILLE Retractor	161
STRATTE Needle holder	307
STRAUSS Penis Clamp	645
STRULLY scissors	45
STRÜMPFEL Ear forceps	749
STRUYCKEN Sharp nasal forceps	770
SUBRAMANIAN ATRAUMA Peripheral vascular clamp	524
SUBRAMANIAN-MINIATURE ATRAUMA	524
Suction attachment	760
SUPER CUT COTTLE scissors	70
SUPER CUT DIETRICH vascular scissors	71
SUPER CUT FOMON scissors	70
SUPER CUT FREEMANN-GORNEY scissors	75
SUPER CUT FREEMANN-KAYE scissors	75
SUPER CUT GOLDMANN-FOX scissors	73
SUPER CUT GORNEY scissors	74
SUPER CUT HEYMANN scissors	70
SUPER CUT iris scissors	72
SUPER CUT JAMESON dissecting scissors	74
SUPER CUT JOSEPH scissors	72
SUPER CUT KAYE FACE LIFT scissors	74

Inhaltsverzeichnis
Alphabetical Index
Indice alfabético
Indice alfabético

USA MOD. Sharp spoon 406

V

Vaginal specula 648-662
 VALLEIX Uterus probe 668
 Valve attachment, single 760
 VAN BUREN Sequester forceps 444
 VAN BUREN Urethral bougie 641
 VAN DOREN Probe-excision forceps 681
 VANNAS Iridectomy scissors 725
 VANNAS MOD.TÜBINGEN Iridectomy scissors 725
 VARADY Phlebotomizer 226
 Various eye knives 707
 VEIDENHEIMER ATRAUMA Clamp 620
 Velcro cuff 264
 VERBRUGGE Bone-holding forceps 452
 VERRÉS Insufflation cannula 242
 VICKERS-EASYDRIVER Drill handle 373
 VIDAL Lupus scraper 850
 VIENNA Nasal speculum 763
 VIGORIMETER Force gauge 252
 VIGORIMETER Rubber balls, alone 252
 VIRKHOV cartilage knife 3
 VIRKHOV knife 4
 VISE MICRO-knotting forceps 96
 VOLKMANN Retractor 162-164
 VOLKMANN Sharp spoon 402,403
 VOLKMANN Sharp spoon d/e 408
 VOLLMAR Ring stripper 228

W

WACHENFELDT Suture forceps 338
 WAGENER Ear retractor 754
 WAGNER Bone lever 430
 WAGNER Raspatory 412,413
 WAGNER scissors 39
 WALB organ knife 4
 WALDMANN episiotomy scissors 29
 WALLICH Abortion spoon 700
 WALTER Osteotome 787
 WALTER Osteotome 787
 WALTER-CARMALT splinter forceps 89
 WALTON Fingerring saw 469
 WALTON Foreign body gouge 708
 WALTON Replacement blade for finger saw 469
 WANGENSTEEN Needle holder 306
 WARTENBERG Sensitivity Instrument 250
 Washing bowl 870
 WASSMUND Retractor 166
 Waste bin 886
 Waste tongs 886
 WATSON-WILLIAMS Sharp nasal forceps 769
 WAUGH surgical forceps 85
 WEBER ATRAUMA Clamp 505
 WEBER Wire snare 712
 WEBER-LOCH Ear loop 753
 WEBSTER Needle holder 301
 WEIL-BLAKESLEY Nasal forceps 770-772
 WEISSBARTH Vaginal speculum 661
 WEITLANER Retractor 199
 WEITLANER-BABY 201
 WEITLANER-LOKTITE Retractor 198
 WEITLANER-WULLSTEIN 200
 WELLS Chalazion spoon 712
 WERTHEIM Hysterectomy clamp 138,139
 WERTHEIM scissors 27
 WERTHEIM-CULLEN Hysterectomy clamp 139
 WEST Flat chisel 715
 WEST Hollow reamer 715
 WESTCOTT Iridectomy scissors 724
 WESTCOTT MICRO-scissors 17

WESTMACOTT Nasal tampon forceps 766
 WHITE (COLVER) Tonsil forceps 834
 WHITE Tonsil forceps 834
 WHITEHEAD Mouth gag 814
 WILDER Lacrimal duct dilator 716
 WILLET-MARTEL Head clamp 121
 WILLIAMS Intestinal grasping clamp 605
 WILLIGER Double spoon 409
 WILLIGER Hammer 395
 WILLIGER Hammer 397
 WILLIGER Raspatory 416,417
 WILLIGER Septum elevator 425
 WILLIGER Sharp spoon 407
 WINTER Abortion forceps 699
 Wire cutters 366
 Wire flat forceps 363-365
 Wire-grasping forceps 363-365
 Wire-guide needle 370
 WIRKSTROEM Clamps 132
 WITTNER Uterus biopsy forceps 682
 WOLFF Lupus curette 850
 WOLFF plaster-cast breakers 349
 Wrench for tunnelling set 538
 WRIGLEY Obstetric forceps 696
 WULLSTEIN Ear sickle knife 734
 WULLSTEIN MICRO-Ear forceps 732
 WULLSTEIN MICRO-Ear scissors 731
 WULLSTEIN MICRO-Suction cannula 235
 X-ray measuring rod 255

Y

YANKAUER Suction tube 238
 YASARGIL Galea retractor 548
 YASARGIL MICRO-forceps 94
 YASARGIL MICRO-grasping forceps 601
 YASARGIL MICRO-instruments 562,563
 YASARGIL MICRO-knife 563
 YASARGIL Needle holder 358
 YASARGIL Pituitary forceps 597
 YASARGIL Sharp spoon 563
 YASARGIL Suction tube 237
 YASARGIL Thread fork 562
 YASARGIL Thread guide 563
 YASARGIL tumor forceps 93
 YASARGIL-SAMMII tumor forceps 93
 YEOMAN Rectum biopsy Forceps 627
 YOUNG Prostate hook 637
 YOUNG Replacement needle 330
 YOUNG Suture Instrument 330
 YOUNG Tongue forceps 818

Z

ZAUFAL-JANSEN Gouge forceps 456
 ZENKER Clamp 131
 ZENKER Retractor 172
 ZIEGLER Eye knife 707
 ZIEGLER Head mirror with headband 260
 ZÖLLNER Ear speculum, black, anodized 741
 ZÖLLNER Suction cannula 236

A

Abrazadera de tubo HOFFMANN	863
Abrazadera de vaso pediátrico COOLEY ATRAUMA	532-534
Abreboca DAVIS-BOYLE	811
Abreboca de silicona DENHARDT	809
Abreboca DENHARDT	809
Abreboca DINGMANN	813
Abreboca DOYEN-JANSEN (MOLT)	809
Abreboca HEISTER	809
Abreboca JENNINGS	814
Abreboca KILNER-DOUGHTY	810
Abreboca MAUNDER	808
Abreboca MC IVOR	812
Abreboca PITHA	808
Abreboca ROSER-KÖNIG	809
Abreboca SIMPLEX	815
Abreboca WHITEHEAD	814
Accesorio de luz fría para fibra óptica MILLIN	639
Accesorio para broncoscopio BRUENINGS	839
Accesorio para broncoscopio CORDES	839
Accesorio para broncoscopio FRAENKEL	839
Accesorio para broncoscopio KRAUSE	839
Accesorio para broncoscopio LANGE	839
Accesorio para broncoscopio ROSENBERG	839
Accesorio para broncoscopio SCHEINMANN	839
Accesorio para broncoscopio SCHUMACHER	839
Accesorio para broncoscopio SIFT	839
Accesorio para pistola de limpieza AQUAJET	879
Accesorios retractores LEYLA	550
Accesorios retractores LEYLA	553
Acoplamiento LEYLA	551,552
Adaptador de tornillo LUER	538
Aglomerantes/cierra-nudos para amígdalas RÖDER	835
Aguja de disección BOWMAN	707
Aguja de repuesto YOUNG	330
Aguja KRONECKER	331
Aguja ocular	291
Aguja para amígdalas DUPUY-WEISS	829
Aguja para amígdalas HURD	829
Aguja para ligadura COOPER	331
Aguja para ligaduras SCHMIEDEN	330
Aguja para ligaduras SCHMIEDEN-DICK	330
Aguja para oído BARBARA	736
Aguja para oído MIKRO BARBARA	735
Aguja para oído ROSEN	736
Aguja para oído ROSEN	735
Aguja para tímpano LUCAE	755
Aguja para tímpano POLITZER	755
Aguja pasa-hilo	370
Aguja pasa-hilo DEMEL	370
Aguja pasa-hilo DEMEL	370
Aguja quirúrgica	288-290
Aguja quirúrgica curvada B.	288
Aguja quirúrgica curvada E.	289
Aguja quirúrgica curvada G.	288
Aguja quirúrgica curvada Ga.	289
Aguja quirúrgica curvada Gr.	289
Aguja quirúrgica intestinal KEITH	290
Aguja quirúrgica intestinal Pb	290
Aguja quirúrgica intestinal Pc	290
Aguja quirúrgica intestinal Pd	290
Aguja REVERDIN	329
Aguja vascular KALT	291
Aguja vascular PAYR	291
Agujas oculares ob	291
Agujas oculares og	291
Agujas para ligaduras	329-334
Agujas para ligaduras BRUNNER	333
Agujas para ligaduras DESCHAMPS	332,333
Agujas REDON	240
Ajustador de oliva	538
Alambre de cerclaje	369
Alfombra de silicona	866
Alicates de extracción para hojas del bisturí	8

Alicates de gubia FRYKHOLM	459
Alicates de gubia STILLE-RUSKIN	458
Alicates de semipunto	767
Alicates de sierra de anillos	469
Alicates para la extracción de yeso WOLFF	349
Alicates planos	363,364
Alicates planos HACKSTOCK	363
Alicates planos para alambre	363-365
Amigdalótomo SLUDDER-BALLENGER	836
Amniotomo BEACHAM	671
Anillo de sellado	693
Anillo ocular CASTROVIEJO	715
Anillos de goma para el ligador hemorroidal	627
Anillos separadores VOLLMAR	228
Articulación esférica LEYLA	551,552
Asas para los enlaces de pólipos nasales	765
Aspirador de disección LANDOLT	234
Aspiradores nasales KILNER	234

B

Bajalenguas BRUENINGS	817
Bajalenguas BRUENINGS	817
Bajalenguas de plástico	817
Bajalenguas DINGMANN	813
Bajalenguas TOBOLD	816
Banda FELDHEIM	468
Bandeja de instrumentos	871
Bandeja de tamiz de esterilización	867
Bandeja multiusos	871
Barra de extensión	372
Barra de extensión KIRSCHNER	371
Barra de extensión para el brazo BÖHLER	371
Barra de extensión para el muslo BÖHLER	371
Bisturí	3
Bisturí anatómico	2
Bisturí de amputación	12,13
Bisturí de amputación CATLIN	12
Bisturí de amputación COLIN	12
Bisturí de amputación LANGENBECK	13
Bisturí de amputación LISTON	12
Bisturí de conización AYRE	2
Bisturí de corte circular MIKRO ROSEN	734
Bisturí de estrella GRAEFFE	706
Bisturí de mioma SEGOND	2
Bisturí de repuesto DAHLGREN	546
Bisturí de repuesto DE VILBISS	546
Bisturí de repuesto para bisturí para adenoides LA FORCE	804
Bisturí de repuesto para el uretrotomo OTIS	643
Bisturí de rodillo SCHUKNECHT	734
Bisturí en hoz WULLSTEIN	734
Bisturí MIKRO YASARGIL	563
Bisturí oscilante BALLENGER	780
Bisturí para adenoides BARNHILL	803
Bisturí para adenoides BECKMANN	802,803
Bisturí para adenoides LA FORCE	804
Bisturí para adenoides ST.CLAIR-THOMSON	804
Bisturí para amígdalas ABRAHAM	830
Bisturí para amígdalas BRUENINGS	830
Bisturí para amígdalas FISCHER	830
Bisturí para corte de cartílago VIRKHOV	3
Bisturí para duramadre HALL	560
Bisturí para duramadre TOENNIS	560
Bisturí para menisco	436,437
Bisturí para menisco BIRCHER	436
Bisturí para menisco NEFF	437
Bisturí para mucosa FREER	779
Bisturí para mucosa TABB	734
Bisturí para ojo KNAPP	706
Bisturí para ojo ZIEGLER	707
Bisturí para órgano WALB	4
Bisturí para rinoplastia CONVERSE	778
Bisturí para rinoplastia COTTLE	778

Bisturí para rinoplastia FOMON	778
Bisturí para rinoplastia JOSEPH	778
Bisturí para rinoplastia JOSEPH	778
Bisturí para tabique completo BRUENINGS	781
Bisturí para tabique FREER	779
Bisturí para yeso de ESMARCH	348
Bisturí para yeso HENNIG	349
Bisturí para yeso HOPKINS	348
Bisturí para yeso LIMPIO	348
Bisturí punta lanza JAEGER-GRIESHABER	706
Bisturí VIRKHOV	4
Bisturís desechables	9,10
Bloqueo CASPAR	572
Bola de valva KABIERKE	757
Bolas de goma sueltas VIGORIMETER	252
Bolsa protectora de plástico para el estuche traqueal	847
Bomba de aire para compresor	354
Bombilla de recambio del oftalmoscopio	259
Bombilla de sustitución de laringoscopio	272
Bombillas de recambio para el otoscopio	259
BONN MOD. Pinzas para iris MOD. BONN	719
Brazo de sujeción la fijación LEYLA	551,552
Brazo de sujeción, flexible LEYLA	549
Broca de perforación CUSHING	358
Broca giratoria ADSON	358
Broca giratoria MC KENZIE	358
Broca giratoria STILLE	357
Brocas D'ERRICO	358
Brocas filiformes Estante de almacenamiento para hilos	378
Brocas filiformes KIRSCHNER	375,376
Brújula de medición de cráneo BERTILLON	253
Bucle de alambre de las amígdalas	835
Bujía uretral GUYON	641
Bujía uretral VAN BUREN	641

C

Cabestrillo de alambre WEBER	712
Cabestrillo para cuerpos extraños estándar	708
Cabezal del otoscopio	259
Cable flexible inoxidable NABATOFF	227
Cadena suelta para el equipo de enfermería	853
Cadena con peso DOYEN	221
Caja de metal NABATOFF	227
Caja de preparación DEPONETTE	864
Caja interna, tapa y base	294
Caja para algodón con tapa con botón	874
Cajas de preparación	865
Calibrador	254
Calibre con graduación JAMESON	254
Cánula BIER	242
Cánula CASTROVIEJO	714
Cánula de aspiración BARRON	236
Cánula de aspiración HOUSE	236
Cánula de aspiración MIKRO BELLUCCI	235
Cánula de aspiración MIKRO WULLSTEIN	235
Cánula de aspiración SCHUKNECHT	236
Cánula de aspiración ZÖLLNER	236
Cánula de enjuague nasal EICKEN-KILLIAN	805
Cánula de insuflación VERRERES	242
Cánula IOWA	240
Cánula KLIMA-ROSSEGGER	243
Cánula KNUTSON-KOCH	644
Cánula LUER LOCK	714
Cánula MENGHINI	241
Cánula para oído KABIERKE	757
Cánula para punción lumbar TUOHY	242
Cánula QUINKE	241
Cánula traqueal CHEVALIER-JACKSON	846
Cánula traqueal LUER	846
Cánula vascular de irrigación SCHMID	242
Captador de hilos	336
Captador de hilos MOD. VIENA	336

Captador de hilos para torniquete RUMEL-BELMONT .541
 Catéter de metal para hombres .642
 Catéter de metal para mujeres .642
 Catéter de oído HARTMANN .746
 Catéter GUYON .644
 Cepillo de limpieza .847,881-885
 Cepillo de manos ASEPTIC .858
 Cepillos de limpieza .881-885
 Cesta de esterilización .868
 Cierra-nudos para amígdalas BRUENINGS .835
 Cierra-nudos para amígdalas EVES .835
 Cierra-nudos para amígdalas TYDING .836
 Cierre de velcro .264
 Cilindro de perforación .872
 Cilindro JANET .246
 Cíncel .380,381,384-385,387-392
 Cíncel ALEXANDER .381
 Cíncel HIBBS .385
 Cíncel HOKE .384
 Cíncel MINI-LAMBOTTE .382
 Cíncel MINI-LEXER .388
 Cíncel OESTE .715
 Cíncel para esternón LEBSCHÉ .474
 Cíncel para tabique FREER .784
 Cíncel PARTSCH .380,381
 Cíncel plano con mango de ferrozell .390,391
 Cíncel STILLE .381
 Cistotomo GRAVE .708
 Clamp para cordón umbilical COLLIN .700
 Clamp para cordón umbilical KANE .700
 Clavo STEINMANN .373
 Colector de hojas de bisturí .8
 Compresor de amputación .354
 Compresor, taladro de uñas .468
 Conductor DE MARTEL .544
 Conexión con forma de oliva .760
 Conexión con hilo cónico .760
 Conjunto para tunelar MARTIN .538
 Cono de carga para el ligador hemorroidal .627
 Cono de inserción con placa de cubierta POLITZER .758
 Contenedor de eliminación de escobillas .860
 Contenedor de metal para conjunto para tunelar .538
 Cortador de cráneo DIAMANT .366
 Cortadores de alambre TC .367,368
 Cortapernos .366
 Cortauñas .854,855
 Costótomo para costillas (mod.) FINOCHIETTO .480
 Costótomo para costillas BABY-BAILEY .485
 Costótomo para costillas BETHUNE .474
 Costótomo para costillas COOLEY .475
 Costótomo para costillas de ALUMINIO BURFORD .477
 Costótomo para costillas de ALUMINIO CASTANEDA .478
 Costótomo para costillas DEBAKEY .481,482
 Costótomo para costillas FINOCHIETTO BABY .476,481
 Costótomo para costillas FINOCHIETTO INFANT .476
 Costótomo para costillas HAIGHT .479
 Costótomo para costillas TUFFIER .479
 Costótomos para costillas .472
 Craneoclasto BRAUN .701
 Craneoclasto TARNIER .701
 Cubierta con hueco triangular .872
 Cubridor suelto .872
 Cuchara y gancho para el oído GROSS .752
 Cucharilla afilada BRUNS .404,405
 Cucharilla afilada HALLE .407
 Cucharilla afilada SCHEDE .403
 Cucharilla afilada SCOVILLE .405
 Cucharilla afilada SPRATT .404
 Cucharilla afilada VOLKMANN .402,403
 Cucharilla afilada VOLKMANN d/e .408
 Cucharilla afilada WILLIGER .407
 Cucharilla afilada YASARGIL .563
 Cucharilla doble MARTINI .409
 Cucharilla doble WILLIGER .409
 Cucharilla para aborto CUZZI .699

Cucharilla para aborto PESTALOZZA .700
 Cucharilla para aborto WALLICH .700
 Cucharilla para chalazión HEBRA .713
 Cucharilla para chalazión MEYHOEFER .713
 Cucharilla para chalazión WELLS .712
 Cucharilla para conducto biliar DESJARDINS .635
 Cucharilla para conducto biliar DESJARDINS .635
 Cucharilla para conducto biliar FERGUSSON .636
 Cucharilla para conducto biliar LUER-KOERTE .635
 Cucharilla para conducto biliar MAYO .636
 Cucharilla para conducto biliar MOORE .636
 Cucharilla para la hipofisectomía MIKRO .564
 Cucharilla para oído LEMPERT .756
 Cucharilla SIMON .406
 Cucharilla uterina SCHROEDER .686
 Cucharilla uterina SIMON .686
 Cuchilla de repuesto para la sierra WALTON .469
 Cuchilla de sustitución de osteótomo .387
 Cuchillas, frágiles .14
 Cuchillo en hoz SCHUKNECHT .734
 Cuchillo para paño PLESTER .734
 Cuchillo/disector para amígdalas CARPENTER .831
 Cuña .876
 Cureta BLAKE .692
 Cureta COAKLEY .802
 Cureta doble HEMINGWAY .409,410
 Cureta doble MILLER-COLBURN .410
 Cureta FAULKNER .802
 Cureta HOUSE .739
 Cureta para biopsia KEVORKIAN .679
 Cureta para biopsia NOVAK .679
 Cureta para biopsia RANDALL .679
 Cureta para lupus FOX .850
 Cureta para lupus WOLFF .850
 Cureta para oído BUCK .751,752
 Cureta para oído JANSEN .752
 Cureta para oído LANGENBECK .751
 Cureta para oído SHAPLEIGH .751
 Cureta RECAMIER .687,688,689
 Cureta SIMS .689,690
 Cureta uterina BUMM .691

D

Dedales LANGENBECK .808
 Depresor de lengua .817
 Depresor de lenguas ANDREW .816
 Depresor de lenguas DINGMANN .817
 Depresor de lenguas HARTMANN .816
 Depresor de lenguas WIEDER .816
 Depresor uterino BRAUN .668
 Dermatólogo HUMBY .11
 Dermatólogo SCHINK .11
 Dermatólogo SILVER .11
 Diapasón .742
 Diapasón de aluminio .742
 Diapasón HARTMANN .742-744
 Diapasón KÖNIG .745
 Diapasón LUCAE .744
 Diapasón NEURO .744
 Diapasón RYDEL-SEIFFERT .744
 DIETHRICH-HEGEMANN .43
 Dilatador cardiovascular TUBBS .539
 Dilatador del conducto lagrimal BAKES .632
 Dilatador del conducto lagrimal WILDER .716
 Dilatador traqueal LABORDE .843
 Dilatador traqueal TROUSSEAU .843
 Dilatador uterino HANK .666
 Dilatador uterino HEGAR .663-665
 Dilatador uterino PRATT .667
 Dilatador vascular COOLEY .536,537
 Escariador vascular DEBAKEY .537
 Dinamómetro COLLIN .253
 Dinamómetro VIGORIMETER .252
 Discos de fijación para las brocas filiformes .372

Disector ático MIKRO AUSTIN .737
 Disector de vasos ROBB .540
 Disector para amígdalas HENKE .832
 Disector para amígdalas HURD .831
 Disector para duramadre DAVIS .558
 Disector para duramadre DAVIS .558
 Disector para duramadre OLIVECROMA .558
 Disector para duramadre PENFIELD .557
 Disector para duramadre TOENNIS .558
 Disector para hipofisectomía MIKRO .564
 Disector para oído de FISH .738
 Disectores, elevadores .425,426
 Dispensador de algodón METHOT .875
 Dispensador de brocas filiformes, múltiple .377
 Dispensador de cepillos MARTIN .858
 Dispositivo de circuncisión COMCO .644
 Dispositivos de suspensión .859,860
 Doble instrumento deslizante CASTROVIEJO .717
 Doble instrumento deslizante DIX .717

E

Elevador ALDERDYCE .426
 Elevador de cuerpo extraño MOLDENHAUER .753
 Elevador de cuerpo extraño ZAUFAL .753
 Elevador del tabique BALLENGER-HAJEK .782
 Elevador del tabique HALLE .781
 Elevador del tabique JOSEPH .781
 Elevador del tabique JOSEPH-MASING .783
 Elevador del tabique MC KENTY .781,782
 Elevador del tabique ROGER .783
 Elevador del tabique WILLIGER .781,782
 Elevador KILLIAN .782
 Elevador LANGENBECK .424,426
 Elevador LANGENBECK .426
 Elevador LEMPERT .756
 Elevador MC DONALD .426
 Elevador MIKRO .425
 Elevador obstétrico SELLHEIM .698
 Elevador para huesos .427,428
 Elevador para huesos BENNETT .432
 Elevador para huesos BLOUNT .433
 Elevador para huesos BUCK-GRAMCKO .427
 Elevador para huesos MINI-HOHMANN .427
 Elevador para oído BUCK .748
 Elevador para oído QUIRE .748
 Elevador PENNINGTON .782
 Elevador perióstico COTTLE .783
 Elevador QUERVIANO .426
 Elevador SEBILEAU .426
 Elevador Septum WILLIGER .425
 Elevadores para huesos HOHMANN .428-431
 Elevadores para huesos LANGE-HOHMANN .430,431
 Elevadores para huesos MÜLLER-VERBRUGGE .431
 Elevadores para huesos WAGNER .430
 Encaje de pólipo nasal KRAUSE .765
 Endospéculos GOODELL .678
 Endospéculos KOGAN .677
 ENGL. Pinzas de campo MOD. INGLÉS .143
 Enlaces los pólipos auditivos .746
 Enlaces los pólipos auditivos KRAUSE .746
 Enlaces los pólipos auditivos KRAUSE-VOSS .746
 Ensordecedor con oliva BARANY .745
 Enucleador de tendones .423,424
 Enucleador de tendones BUNNEL .438
 Enucleador de tendones FISCHER .439
 Enucleador de tendones PUTTI .424
 Enucleador de tendones TC-MILLER-COLBURN .423
 Enucleador HARDY .562
 Enucleador HARY-FAHLBUSCH .562
 Escariador .356
 Escariador con mango en T .356
 Escariador PERTHES .356
 Escofina nasal (WIENER) AUFRICHT .793
 Escofina nasal FOMON .795

Escofina nasal GALLAHER	793	Espéculos para oído TOYNBEE	740	Ganchos para oído MIKRO MC GEE	736
Escofina nasal LEWIS	794	Espéculos rectal SCHULZE-BERGMANN	624	Ganchos para oído WAGENER	754
Escofina nasal MALTZ	792	Espéculos vaginales	648-662	Goniómetro CAROLL	253
Escudo protector para amputación PERCY	355	Espejo frontal con anillo frontal ZIEGLER	260	Grapas de plata MC KENZIE	547
Eslinga para oído BILLEAU	753	Espejo laríngeo	842	Grapas para cuero cabelludo RANEY	548
Eslinga para oído WEBER-LOCH	753	Espejo laríngeo MICHEL	842	Grapas y pinzas aplicadoras MC KENZIE	547
Esparcidor de laminectomía completo CASPAR	569-574	Estación de carga para mango con luz fría	280	Grapas y pinzas aplicadoras OLIVECRONA-TOENNIS	547
Esparcidor de laminectomía SCOVILLE	566	Estetoscopio anestófono	251	Grifo estomacal MOHR	763
Esparcidor de yeso MOD. USA	349	Estetoscopio BABY-DUPLEX	251	Gubia ALEXANDER	381
Espátula	553	Estetoscopio DUPLEX	251	Gubia COBB	392
Espátula abdominal	195	Estetoscopio PINARD, ALUMINIO	250	Gubia DAHMEN	393,394
Espátula abdominal HABERER	195	Estetoscopio PINARD, madera	250	Gubia MINI-LEXER	388
Espátula abdominal REVERDIN	195	Estuche para instrumentos	873	Gubia para cueros extraños MEYER	708
Espátula abdominal RIBBON	195	Estuche traqueales	847,848	Gubia para cuerpos extraños WALTON	708
Espátula CASTROVIEJO	712	Estuches de instrumentos	873	Gubia para tabique BALLENGER	785
Espátula CASTROVIEJO-BARRAQUER	711			Gubia para tabique KILLIAN	785
Espátula de autoretencción LEYLA	549,551	F		Gubia para tabique KILLIAN	785
Espátula ELSCHNIG	712	Fijación del soporte ROCHARD	222	Gubia STILLE	381
Espátula flexible DAVIS	553	Fijación del tornillo para el conjunto para tunelar	538	Gubia ZIELKE	390
Espátula HEIFETZ	553	Fijador 1 pinzas, 2 brazos de sujeción LEYLA	550	Gubias	380,381,383-385,387-394
Espátula Intima	539	Fijador LEYLA	549	Gubias HIBBS	385
Espátula KADER	190	Fijador ROCHARD	222	Gubias LEXER	389,390
Espátula KUEMMEL	190	Filtro especial textil de repuesto	865	Gubias OESTE	715
Espátula lingual MC IVOR	812	FINOCHIETTO	476	Gubias SMITH-PETERSON	383
Espátula OLIVECRONA	553	Flebodisecador FARRELL	229	Guía de la sonda hueca, ferrozell	337
Espátula para laringoscopia MC INTOSH	270,275,276	Flebodisecador VARADY	226	Guía de ligadura YASARGIL	563
Espátula para laringoscopia TELESCOPE	273	Fórceps de cuchara para oído HARTMANN	749		
Espátula pulmonar ALLISON	486	Fórceps de cuchara para oído HARTMANN-HOFFMANN	749	H	
Espéculo AUVARD	661	Frasco suelto KABERSKE	757	HARKEN	488
Espéculo BREISKY	662	Frasco suelto UNIVERSAL	806	Histerometrós COLLIN	668
Espéculo CASPAR	575	Fresa HUDSON	358	Histerometrós MARTIN	668
Espéculo de hipofisectomía LANDOLT-CUSHING	561	Fresador STILLE	357	Histerometrós SIMS	668
Espéculo de oído	259			Histerometrós VALLEIX	668
Espéculo de oído anodizado negro ZÖLLNER	741	G		HOHMANN-ALDINGER	431
Espéculo de oído, reutilizable	259	Gancho con cierre rápido CASPAR	569,570	Hoja de bisturí	7,8
Espéculo de oído, uso único	259	Gancho cutáneo GILLIES	851	Hoja de cincel	387
Espéculo DOYEN	659	Gancho cutáneo KAYE	851	Hoja de repuesto CHARRIERE	353
Espéculo EASTMAN	651	Gancho cutáneo KILNER	850	Hoja de repuesto para la sierra MARTIN	469
Espéculo GRAVE	650	Gancho de Cystitikus PRATT	626	Hoja de sierra de repuesto	469
Espéculo KALLMORGEN	658	Gancho de fijación doble GUTHRIE	709	Hoja de sierra de repuesto BIER	352
Espéculo nasal BECKMANN	765	Gancho de tracción para barra de extensión, grande	372	Hoja de sierra de repuesto RUST	352
Espéculo nasal COTTLE	764	Gancho de tracción para barra de extensión, pequeño	372	Hoja de sierra para sierra para yeso oscilante	350
Espéculo nasal GOLDSMITH (THUDICHUM)	762	Gancho en forma silla de montar COTTLE	800	Hoja de sierra SATTERLEE	353
Espéculo nasal HARTMANN	763	Gancho galea YASARGIL	548	Hoja de sustitución de gubia	387
Espéculo nasal HARTMANN-HALLE	762	Gancho KNAPP-ROLLET	709	Hoja de sustitución para dermatomo HUMBY	11
Espéculo nasal KILLIAN	764	Gancho nasal COTTLE	796	Hoja de sustitución suelta	11
Espéculo nasal TIECK-HALL	763	Gancho para amígdalas NAGER	833	Hoja SLUDDER-BALLENGER	836
Espéculo nasal WIEN	763	Gancho para estrabismo GRAEFE	710	Horquilla de hilos YASARGIL	562
Espéculo para oído BOUCHERON	741	Gancho para fistula SIMON	676	Horquilla para implantar HARDY	562
Espéculo para oído FARRIOR	740	Gancho para glándula lagrimal AXENFELD	710		
Espéculo para oído HARTMANN	740	Gancho para hipofisectomía MIKRO	564	I	
Espéculo para oído HARTMANN	740	Gancho para mucosa FREER	799	Instrumento de circuncisión	644
Espéculo PEDERSON	650	Gancho para mucosa JOSEPH	799	Instrumento de circuncisión MOGEN	644
Espéculo rectal BARR	623	Gancho para nervios CRILE	540	Instrumento de coger tendones CAROLL	441
Espéculo rectal BODENHAMMER	622	Gancho para ojo KNAPP	709	Instrumento de dedo FELDHEIM	468
Espéculo rectal de CZERNY	622	Gancho para ojo ROLLET	709	Instrumento de sensibilidad WARTENBERG	250
Espéculo rectal MATHIEU	624	Gancho para ramus OBWEGESER	820	Instrumento de sutura YOUNG	330
Espéculo rectal PRATT	623	Gancho para sonda MIKRO SHEA	737	Instrumento de uretrografía KNUTSON	644
Espéculo rectal SIMS	622	Gancho SCOVILLE	566,567	Instrumento doble, enrosicable	717
Espéculo SCHERBACK	660	Gancho thymus LUKENS	845	Instrumento para apertura craneal CONE	546
Espéculo SIMS	652	Gancho traqueal BOSE	844	Instrumento para apertura craneal DAHLGREN	546
Espéculo vaginal COLLIN	649	Gancho traqueal ITERSON	844	Instrumento para apertura craneal VILBISS	546
Espéculo vaginal CRYSTAL	653-657	Gancho traqueal JACKSON	844,845	Instrumento para coger tendones	440,441
Espéculo vaginal CUSCO	648	Gancho traqueal LUER	844	Instrumento para fibroma DOYEN	676
Espéculo vaginal DOYEN	662	Gancho traqueal ROSE	844	Instrumentos MIKRO KOOS	563
Espéculo vaginal estándar CUSCO	649	Ganchos para iris GRAEFE	708	Instrumentos MIKRO KRAUS	563
Espéculo vaginal JACKSON	651	Ganchos para la tiroides SCHOENBORN	845	Instrumentos MIKRO YASARGIL	562,563
Espéculo vaginal LANDAU	662	Ganchos para oído DAY	754	Instrumentos para apertura craneal	544
Espéculo vaginal lateral	678	Ganchos para oído HARTMANN	753	Instrumentos para colocar grapas	547
Espéculo vaginal SEMM	650	Ganchos para oído LUCAE	754	Instrumentos para colocar grapas, gancho galea	547
Espéculo vaginal SEYFFERT	650	Ganchos para oído MIKRO	736,737	Insuflador de aire POLITZER	758
Espéculo vaginal SIMS	652				
Espéculo vaginal TRELAT	651				
Espéculo vaginal WHITEBARTH	661				
Espéculos grandes EASTMAN	651				
Espéculos MATHIEU	659				

J

Jeringa de insulina LUER 245
 Jeringa para heridas y ampollas JANET 246
 Jeringa para heridas y ampollas LUER-LOCK 246
 Jeringa para oído 760
 Jeringa para oído PURE 759
 Jeringa TUBERKULIN-LUER 246
 Juego completo de retractores LEYLA 551
 Juego de clips MINI-Assistent 340
 JUEGO DE COMBINACIONES 258
 Juego de diagnóstico 258
 Juego de dilatador del conducto biliar BAKES 632
 Juego de laringoscopia FOREGGER 271,277,278
 Juego de laringoscopia GUEDEL-NEGUS 269
 Juego de laringoscopia MILLER 267,268,274
 Juego de laringoscopia MILLER-BABY 267
 Juego de llaves para tunelar 538
 Juego de oftalmoscopia 257
 Juego de otoscopio 256
 Juego de PINZAS suturas en un estuche de metal 339
 Juego de trépanos completo para plato KEYES 851
 Juego para varices NABATOFF 227

L

Lámpara de repuesto de luz fría para laringoscopios 279
 Laringoscopios quirúrgicos con portadores de luz de fibra óptica 280-284
 Laringoscopios quirúrgicos HOLINGER 281
 Laringoscopios quirúrgicos JACKSON 281
 Lata de agujas 292-294
 Lente BERGER 263
 Lezna para mandíbula KELSEY-FRY 827
 Lezna para mandíbula OBWEGESER 826
 Ligador hemorroidal MC GIVNEY 627
 Ligador hemorroidal RUDD 627
 Lima de uñas 855
 Lima nasal COTTLE 793
 Lima nasal FOMON 794
 Lima nasal JOSEPH 792
 Lima nasal TC-FOMON 795
 Lima para huesos MILLER-COLLBURN 421,422
 Linterna frontal CLAR 261,262
 Llave de sujeción 350
 Llave giratoria suelta CASPAR 569
 Lupa frontal completa BERGER 263

M

Machacadora de cartilago con pinzas de presión 791
 Mango con luz fría 280
 Mango de aspiración COUPLAND 239
 Mango de batería para herramientas de diagnóstico 259
 Mango de espejo laríngeo 842
 Mango de ferrozell para hoja reemplazable de cincel 387
 Mango de la batería 272,279
 Mango de perforación VICKERS-EASYDRIVER 373
 Mango del oftalmoscopio 259
 Mango ELLIOT 714
 Mango KEYES 851
 Mango para anillos separadores 228
 Mango para espéculo vaginal SCHERBAK 660
 Mango para pinzas para biopsia 684
 Mango para sierra de alambre GIGLI 544
 Mango SLUDDER-BALLENGER 836
 Mango suelto NABATOFF 227
 Mango universal HUBER 838
 MANGO UNIVERSAL para el juego para tunelar 538
 Mangos de bisturí 5,6
 Manguera de conexión 760
 Manguito de brazo para compresor 354
 Manguito de muslo para compresor 354

Mano de plomo para adultos 467
 Mano de plomo para niños 467
 Manómetro con bola de goma 265
 Manómetro para compresor 354
 Marco CASPAR 569-574
 Marco DENIS-BROWNE 220
 Marco FRANZ 221
 Marco KIRSCHNER 218
 Marco para abreboca MC IVOR 812
 Marco SCOVILLE 566
 Marco SCOVILLE-HAVERFIELD 566
 Marco SEMM 220
 Marco suelto MILLIN 639
 Martillo 393-401
 Martillo BABINSKI 249
 Martillo BERGMANN 398
 Martillo BERGMANN 399
 Martillo BERLINER 248
 Martillo BUCK 249
 Martillo COLLIN 396
 Martillo con mango de plástico 400
 Martillo COTTLE 397
 Martillo de ferrozell 400
 Martillo de metal 401
 Martillo DEJERINE 248
 Martillo DOYEN 395
 Martillo GERZOG 398
 Martillo HAJEK 398
 Martillo HEATH 399
 Martillo KIRK 398
 Martillo KIRK 400
 Martillo LUCAE 396
 Martillo MEAD 397
 Martillo OMBREDANNE 399
 Martillo PARTSCH 397
 Martillo RABINER 249
 Martillo TAYLOR 248
 Martillo TROEMMER 248
 Martillo WILLIGER 395
 Martillo WILLIGER 397
 Martillo, sin retroceso con mango de plástico 400
 Medidor de presión 694
 Meniscotoma SMILLIE 436
 MICHEL MOD. Pinzas MOD. MICHEL 338
 Micropinzas para anudar 95-96
 MIKULICZ 188
 MILLIGAN 201
 Minicureta para hipófisis HARDY 561
 Minicureta para hipófisis RAY 561
 Monitor de presión sanguínea de pared 265
 Monitor para la presión sanguínea 264
 Muestra y cureta de aspiración 693

O

Obturator plástico IVES-FANSLER 625
 Oliva auditiva BARANY 745
 Oliva de metal 760
 Oliva NABATOFF 227
 Osteótomo CINELLI 788
 Osteótomo COTTLE 786
 Osteótomo COTTLE 786,787
 Osteótomo DAHMEN 393,394
 Osteótomo FOMON 788
 Osteótomo HIBBS 384,385
 Osteótomo LAMBOTTE 382
 Osteótomo LEXER Spongiosa 388
 Osteótomo NEIVERT-ANDERSON 788
 Osteótomo OBWEGESER 823,824
 Osteótomo PARKES 790
 Osteótomo RUBIN 787
 Osteótomo SHEEHAN 789
 Osteótomo SILENCIOSO 381
 Osteótomo SILVER 790

Osteótomo SMITH-PETERSON 383
 Osteótomo WALTER 787
 Osteótomo WALTER 787
 Osteótomos 380,381-385,387-393
 Osteótomos LEXER 389

P

Palanca de luxación MURPHY-LANE 433
 Papelera 886
 Papelera para algodón METHOT 875
 Pastillero 874
 Pelvímeter COLLIN 695
 Pelvímeter COLLYER 695
 Pelvímeter MARTIN 695
 Perforador para Chrutchfield 545
 Perforador SMELLIE 700
 Perióstomas para lupus VIDAL 850
 Perióstotomo COTTLE 782
 Perióstotomo JOSEPH 783
 Perióstotomo 411-420
 Perióstotomo ADSON 420
 Perióstotomo COBB 414
 Perióstotomo de succión GUILLEN 805
 Perióstotomo DOYEN 417,418
 Perióstotomo FARABEUF 416
 Perióstotomo LAMBOTTE 418
 Perióstotomo LANGENBECK 415
 Perióstotomo MASING 783
 Perióstotomo MIKRO 564
 Perióstotomo OBWEGESER 822,823
 Perióstotomo para oído MIKRO ROSEN 738
 Perióstotomo SEDILOT 416
 Perióstotomo SEMB 419
 Perióstotomo WAGNER 412,413
 Perióstotomo WILLIGER 416,417
 Perióstotomo y costótomo ALEXANDER 420
 Perióstotomo y costótomo MATSON 420
 Peso para espéculo vaginal SCHERBAK 660
 Pieza de acoplamiento 693
 Pieza intermedia LUER-LOCK 244
 Pinza 94
 Pinzas ATRAUMA BRUNNER 619
 Pinzas ADSON 124
 Pinzas ALLIS ATRAUMA 604
 Pinzas anatómicas 78-80
 Pinzas anatómicas ADSON 78
 Pinzas anatómicas BROPHY 79
 Pinzas anatómicas CUSHING 80
 Pinzas anatómicas DUEHRSEN 80
 Pinzas anatómicas estándar 78
 Pinzas anatómicas GERALD 80
 Pinzas anatómicas GRAEFFE 88
 Pinzas anatómicas MC INDOE 79
 Pinzas anatómicas Mikro-Adson 78
 Pinzas anatómicas MOD. INGLÉS 80
 Pinzas anatómicas MOD. USA 78
 Pinzas anatómicas POTTS-SMITH 79
 Pinzas anatómicas RAMSEY 80
 Pinzas anatómicas SEMKEN 79
 Pinzas anatómicas TAYLOR 79
 Pinzas anatómicas TC-ADSON 97
 Pinzas anatómicas TC-CUSHING 97
 Pinzas anatómicas TC-CUSHING-TAYLOR 97
 Pinzas anatómicas TC-MC INDOE 98
 Pinzas anatómicas TC-POTTS-SMITH 98
 Pinzas anatómicas TC-SEMKEN 98
 Pinzas anatómicas TC-STANDARD 97
 PINZAS ARTERIALES 107-119
 Pinzas arteriales BABY-OVERHOLT 111
 Pinzas arteriales CARREL 108
 Pinzas arteriales CRILE 110
 Pinzas arteriales CRILE-RANKIN 111
 Pinzas arteriales DIXON-LOVELACE 111

Pinzas arteriales HARTMANN.....	108	Pinzas de campo SCHAEDEL.....	143	Pinzas LUCAE.....	747
Pinzas arteriales KELLY.....	110	Pinzas de campo TOHOKU.....	145	Pinzas MARTEL.....	121
Pinzas arteriales KELLY-RANKIN.....	110	Pinzas de campo y para papel BALL+SOCKET.....	144	Pinzas MC QUIGG-MIXTER.....	134
Pinzas arteriales KOCHER.....	116	Pinzas de esterilización.....	862	Pinzas MICHEL.....	338
Pinzas arteriales KOCHER-DELICATE.....	116	Pinzas de fijación BARRAQUER (COLIBRI).....	719	Pinzas MIKRO.....	92
Pinzas arteriales KOCHER-OCHSNER.....	117,118	Pinzas de fijación BARRAQUER CATSON (COLIBRI).....	719	Pinzas MIKRO TC-ADSON.....	97,98
Pinzas arteriales KROENLEIN.....	109	Pinzas de fijación BARRAQUER-CATSIN.....	719	Pinzas MIKRO YASARGIL.....	94
Pinzas arteriales MOSQUITO-DANDY.....	109	Pinzas de fijación TROUTMAN (COLIBRI).....	719	Pinzas MIKRO-ADSON.....	124
Pinzas arteriales PEAN.....	113	Pinzas de reducción.....	443	Pinzas MIXTER.....	132-134
Pinzas arteriales PEAN-DELICATE.....	113	Pinzas de secuestro.....	444	Pinzas MIXTER-O'SHAUGNESSY.....	132
Pinzas arteriales ROCHESTER-DELICATE.....	114,115	Pinzas de secuestro VAN BUREN.....	444	Pinzas MOSQUITO-DEBAKEY ATRAUMA.....	493
Pinzas arteriales SPENCER-WELLS.....	112	Pinzas de sutura BONACCOLTO.....	721	Pinzas musculares MASTIN.....	849
Pinzas arteriales Terrier.....	108	Pinzas de sutura CASTROVIEJO.....	720	Pinzas nasales afiladas BRUENINGS.....	768
Pinzas arteriales TOENNIS.....	130	Pinzas de sutura CHILDE.....	337	Pinzas nasales afiladas HARTMANN.....	769
Pinzas ATRAUMA PEAN-DEBAKEY.....	494,495	Pinzas de sutura HEGENBARTH.....	338	Pinzas nasales afiladas HEYMANN.....	767
Pinzas ATRAUMA SATINSKY.....	506	Pinzas de sutura MICHEL.....	337	Pinzas nasales afiladas KNIGHT.....	767
Pinzas ATRAUMA URO-TANGENCIAL.....	136	Pinzas de sutura NUGENTES.....	721	Pinzas nasales afiladas LUC.....	768
Pinzas atraumáticas DEBAKEY.....	489	Pinzas de sutura WACHENFELDT.....	338	Pinzas nasales afiladas SCHMEDEN.....	769
Pinzas BABCOCK ATRAUMA.....	606	Pinzas de tapa con cilindro de pie.....	861	Pinzas nasales afiladas STRUYCKEN.....	770
Pinzas BABY-ADSON.....	124	Pinzas de uñas RADOLF.....	469	Pinzas nasales afiladas WATSON-WILLIAMS.....	769
Pinzas BABY-MIXTER.....	123	Pinzas DEBAKEY ATRAUMA.....	489	Pinzas nasales CONVERSE.....	796,798
Pinzas BAINBRIDGE.....	122	Pinzas dermatológicas COTTLE.....	801	Pinzas nasales KILNER.....	798
Pinzas BAINBRIDGE ATRAUMA.....	496	Pinzas esterilizadora BUNT.....	863	Pinzas nasales LANGE.....	796
Pinzas BENGOLEA.....	119	Pinzas esterilizadora MAYO.....	863	Pinzas nasales NEIVERT.....	800
Pinzas BIRKETT.....	125	Pinzas esterilizadora CHEATTLE.....	862	Pinzas nasales WEIL-BLAKESLEY.....	770-772
Pinzas bronquiales CHEVALIER-JACKSON.....	838	Pinzas esterilizadoras ROGGE.....	862	Pinzas obstétricas KIELLAND.....	697
Pinzas bronquiales PRICE-THOMAS.....	486	Pinzas esterilizadoras UNIVERSAL.....	862	Pinzas obstétricas LEE.....	696
Pinzas bronquiales SEMB.....	486	Pinzas etmoidales TAKAHASHI.....	769	Pinzas obstétricas MCLEAN-LUIKART.....	697
Pinzas BUIE.....	121	Pinzas FERGUSSON.....	121	Pinzas obstétricas MCLEAN-TUCKER.....	697
Pinzas bulldog.....	101-152	Pinzas FINOCHIETTO.....	134	Pinzas obstétricas NAEGELE.....	697
Pinzas bulldog CLOVER ATRAUMA.....	491,492	Pinzas gástricas doble LANE.....	611	Pinzas obstétricas PIPER.....	697
Pinzas bulldog DEBAKEY ATRAUMA.....	490	Pinzas gástricas NUSSBAUM.....	612	Pinzas obstétricas SIMPSON.....	696
Pinzas bulldog DEBAKEY-DIETRICH.....	105	Pinzas gastrointestinales PAYR.....	613	Pinzas obstétricas SIMPSON-BRAUN.....	696
Pinzas bulldog DEBAKEY-SATINSKY ATRAUMA.....	490	Pinzas gastrointestinales PAYR-BABY.....	613	Pinzas obstétricas WRIGLEY.....	696
Pinzas bulldog DIEFFENBACH.....	106	Pinzas gubias.....	453 - 460	Pinzas OVERHOLT.....	125
Pinzas bulldog DIETRICH.....	105	Pinzas gubias BEYER.....	456	Pinzas OVERHOLT-BEISSENDOERFER.....	127
Pinzas bulldog GLOVER ATRAUMA.....	491,498	Pinzas gubias BLUMENTHAL.....	455	Pinzas para aborto SAENGER.....	698
Pinzas bulldog HESS.....	106	Pinzas gubias BÖHLER.....	456	Pinzas para aborto WINTER.....	699
Pinzas bulldog JOHNS-HOPKINS.....	106	Pinzas gubias BUMENTAL.....	455	Pinzas para agarre de DIU.....	685
Pinzas bulldog para arterias TITAN.....	103	Pinzas gubias CLEVELAND.....	454	Pinzas para agarre de DIU SERPENTINE.....	685
Pinzas bulldog para venas TITAN.....	102	Pinzas gubias ECHLIN.....	458	Pinzas para alambre.....	366
Pinzas bulldog SANTULLI ATRAUMA.....	492	Pinzas gubias FRIEDMANN.....	453	Pinzas para alambre TC.....	365
Pinzas CASPAR.....	570	Pinzas gubias FRIEDMANN-VICKERS.....	453	Pinzas para alambres TC.....	366-368
Pinzas cierra-hilos TC.....	362	Pinzas gubias HARTMANN.....	454	Pinzas para algodón BOZEMANN.....	150
Pinzas cierra-hilos TC-BARRY-STERNDAL.....	362	Pinzas gubias JANSEN.....	454, 456	Pinzas para algodón CHERON.....	149
Pinzas cierra-hilos TC-CORWIN-HEGAR.....	362	Pinzas gubias JANSEN.....	456	Pinzas para algodón COLLIN.....	149
Pinzas cortantes para huesos BÖHLER.....	463	Pinzas gubias LEKSELL-SILENT.....	458	Pinzas para algodón ULRICH.....	148
Pinzas cortantes para huesos CLEVELAND.....	462	Pinzas gubias LEMPERT.....	455	Pinzas para amígdalas BLOHMKE.....	834
Pinzas cortantes para huesos COTTLE-KAZANJIAN.....	462	Pinzas gubias LUER.....	455	Pinzas para amígdalas HARTMANN.....	837
Pinzas cortantes para huesos LISTON.....	461	Pinzas gubias MARQUARDT.....	457	Pinzas para amígdalas MIKRO.....	834
Pinzas cortantes para huesos LISTON-KEY.....	466	Pinzas gubias MAYFIELD.....	456	Pinzas para amígdalas MIKULICZ.....	834
Pinzas cortantes para huesos MARKWALDER.....	462	Pinzas gubias MEAD.....	454	Pinzas para amígdalas NEGUS.....	133
Pinzas cortantes para huesos MC INDOE.....	463	Pinzas gubias MINI-FRIEDMANN.....	453	Pinzas para amígdalas SCHNIDT.....	834
Pinzas cortantes para huesos RUSKIN.....	463	Pinzas gubias RUSKIN.....	457	Pinzas para amígdalas WHITE.....	834
Pinzas cortantes para huesos SEMB.....	466	Pinzas gubias SAUERBRUCH.....	460	Pinzas para amígdalas WHITE (COLVER).....	834
Pinzas cortantes para huesos STILLE-LISTON.....	464,465	Pinzas gubias SEMB.....	457	Pinzas para anastomosis COOLEY ATRAUMA.....	525
Pinzas CRAFOORD.....	126	Pinzas gubias STELLBRINK.....	453	Pinzas para anastomosis COOLEY-BECK ATRAUMA.....	530
Pinzas CRAFOORD-SELLORS.....	126	Pinzas gubias STILLE.....	457	Pinzas para anastomosis COOLEY-DERRA ATRAUMA.....	530
Pinzas craneales.....	546	Pinzas gubias STILLE-LUER.....	459,460	Pinzas para anastomosis DE MARTEL-WOLFSON.....	614
Pinzas DANDY.....	109	Pinzas gubias ZAUFAL-JANSEN.....	456	Pinzas para aneurismas BAHNSON-DEBAKEY.....	511
Pinzas de agarre para la hipofisectomía MIKRO.....	565	Pinzas GUYON.....	134	Pinzas para antro CITELLI.....	750, 837
Pinzas de aplicación para pinzas bulldog.....	491	Pinzas HALSTEAD-MOSQUITO.....	106,107	Pinzas para anudar MIKRO AUSTIN.....	96
Pinzas de aplicación para pinzas bulldog TITAN.....	104	Pinzas HAYES ATRAUMA.....	619	Pinzas para anudar MIKRO LAZAR.....	96
Pinzas de campo.....	143-145	Pinzas HEANEY.....	140	Pinzas para anudar MIKRO VISE.....	96
Pinzas de campo BACKHAUS.....	143	Pinzas HEISS.....	123	Pinzas para aorta ATRAUMA DIETRICH.....	517
Pinzas de campo BERNHARD.....	144	Pinzas hemostática uterina GREEN-ARMYTAGE.....	698	Pinzas para aorta atraumáticas DEBAKEY.....	504
Pinzas de campo con soporte ROBIN.....	145	Pinzas JOHNS-HOPKINS.....	125	Pinzas para aorta HARKEN ATRAUMA.....	507
Pinzas de campo GROSS.....	146	Pinzas KEYES.....	851	Pinzas para aorta LAMBERT-KAY ATRAUMA.....	509
Pinzas de campo HOFF.....	145	Pinzas KÖLNER.....	548	Pinzas para aorta LEES ATRAUMA.....	508
Pinzas de campo JONES.....	143	Pinzas LAHEY.....	134	Pinzas para aorta MORRIS-DEBAKEY.....	510
Pinzas de campo LANE.....	144	Pinzas LERICHE.....	109	Pinzas para aorta OCHSNER ATRAUMA.....	517
Pinzas de campo LORNA.....	144	Pinzas linguales COLLIN.....	818	Pinzas para arterias, pinzas para	
Pinzas de campo PEAN.....	146	Pinzas linguales de goma YOUNG.....	818	vendajes y para algodón.....	101-152
Pinzas de campo PEERS.....	145	Pinzas linguales YOUNG.....	818	Pinzas para astillas.....	100
Pinzas de campo ROEDER.....	144	Pinzas LOWER.....	134	Pinzas para astillas FEILCHENFELD.....	90

Pinzas para astillas HUNTER.....	89	Pinzas para escisión de prueba SCHUBERT	680	Pinzas para meniscos BIRCHER-GANSKE	442
Pinzas para astillas PEET	100	Pinzas para escisión de prueba THOMS GAYLOR.....	681	Pinzas para oído alligator MINI MCGEE	729
Pinzas para astillas RALK (VIRTUS)	100	Pinzas para escisión de prueba VAN DOREN	681	Pinzas para oído BEYER	750
Pinzas para astillas STIEGLITZ.....	100	Pinzas para esponja BOZEMANN-DOUGLAS	150	Pinzas para oído en forma de cucharilla MIKRO	730
Pinzas para astillas WALTER-CARMALT	89	Pinzas para esponja FOERSTER	150,151	Pinzas para oído HARTMANN	748,749
Pinzas para astillas, micropinzas.....	89-91	Pinzas para esponja RAMPLEY	149,151	Pinzas para oído HARTMANN-WULLSTEIN	749
Pinzas para astillas, micropinzas con clavija	89	Pinzas para esponja RAMPLEY.....	151	Pinzas para oído HOUSE-DIETER	732,731
Pinzas para astillas, micropinzas sin clavija	89	Pinzas para hipófisis YASARGIL	597	Pinzas para oído LITTAUER	748
Pinzas para biopsia BABY-TISCHLER	683	Pinzas para histerectomía	138-142	Pinzas para oído MIKRO	728-730
Pinzas para biopsia BURKE	683	Pinzas para histerectomía HEANEY-BALLENTINE	140	Pinzas para oído MIKRO FULLER	731
Pinzas para biopsia de útero ALEXANDER	682	Pinzas para histerectomía HEANEY-KANTER	141	Pinzas para oído MIKRO MC GEE	732
Pinzas para biopsia de útero EPPENDORFER	682	Pinzas para histerectomía HEANEY-REZEK	140	Pinzas para oído MIKRO WULLSTEIN	728
Pinzas para biopsia de útero KEVORKIAN	682	Pinzas para histerectomía MAINGOT	141	Pinzas para oído MIKRO WULLSTEIN	732
Pinzas para biopsia de útero SCHUMACHER	682	Pinzas para histerectomía MIKULICZ	139	Pinzas para oído STRÜMPPEL	749
Pinzas para biopsia de útero WITTNER	682	Pinzas para histerectomía MOYNIHAN	138	Pinzas para oído TILLEY	748
Pinzas para biopsia KEVORKIAN-PACIFIC	683	Pinzas para histerectomía PHANEUF	138	Pinzas para oído TROELTSCH (WILDE)	747
Pinzas para biopsia MINI-TOWNSEND	683	Pinzas para histerectomía FARABEUF-ATRAUMA	142	Pinzas para oídos HEYWOOD-SMITH	615
Pinzas para biopsia MINI-TOWNSEND (BABY-TISCHLER) ..	684	Pinzas para histerectomía SEGOND-LANDAU	139	Pinzas para órganos DISC ATRAUMA	615
Pinzas para biopsia rectal YEOMAN	627	Pinzas para histerectomía WERTHEIM	138,139	Pinzas para pene STOCKMANN	645
Pinzas para biopsia TISCHLER-KEVORKIAN	683	Pinzas para histerectomía WERTHEIM-CULLEN	139	Pinzas para pene STRAUSS	645
Pinzas para biopsia TISCHLER-MORGAN	683	Pinzas para huesos	442-451	Pinzas para peritoneo ATRAUMA	137
Pinzas para biopsia TOWNSEND	684	Pinzas para huesos BABY-KERN	445	Pinzas para peritoneo FAURE	137
Pinzas para biopsia TOWNSEND-MINI (BABY-TISCHLER) ..	684	Pinzas para huesos DINGMANN	442	Pinzas para peritoneo MIKULICZ	137
Pinzas para bocio BRAUN	849	Pinzas para huesos FARABEUF	446	Pinzas para peritoneo, pinzas para histerectomía ..	138,138
Pinzas para bocio LAHEY	849	Pinzas para huesos FARABEUF-LAMBOTTE	446	Pinzas para pólipos HEYWOOD-SMITH	628
Pinzas para cálculos renales ELÄSSER	631	Pinzas para huesos FERGUSSON	444	Pinzas para pólipos laríngeos JURASZ	840
Pinzas para cálculos renales GUYON ATRAUMA	134	Pinzas para huesos FRESCOS	444	Pinzas para pólipos LUER	628
Pinzas para cálculos renales HEIMING	630	Pinzas para huesos KERN	445,446	Pinzas para pólipos nasales CRAIG	767
Pinzas para cálculos renales HERRICK	136	Pinzas para huesos LAMBOTTE	447	Pinzas para pólipos uterinos NOTO	674
Pinzas para cálculos renales RANDALL	629,630	Pinzas para huesos LANE	448	Pinzas para poner y quitar grapas RANEY	548
Pinzas para cálculos renales STILLE	136	Pinzas para huesos LANGENBECK	444,445	Pinzas para próstata en forma de T MILLIN	638
Pinzas para carótida COOLEY ATRAUMA	525	Pinzas para huesos LEWIN	443	Pinzas para próstata en forma en Allis MILLIN	638
Pinzas para carótida GREGORY ATRAUMA	492	Pinzas para huesos MARTIN	442	Pinzas para prostatectomía MILLIN ATRAUMA	638
Pinzas para carótida GREGORY SOFT ATRAUMA	492	Pinzas para huesos SEMB	446	Pinzas para pulmones LOVELACE	487
Pinzas para catéter COOLEY ATRAUMA	529	Pinzas para huesos TUFFIER	447	Pinzas para pulmones LOVELACE	487
Pinzas para catéter MAGILL	266	Pinzas para huesos ULRICH	449, 450	Pinzas para reposiciones ROWE	828
Pinzas para cerrar clamps DE MARTEL-WOLFSON	614	Pinzas para huesos VERBRUGGE	452	Pinzas para sujeción de huesos GERSTER	361
Pinzas para chalazión AYER	722	Pinzas para huesos, autocentrantes	451	Pinzas para sujeción de huesos LOWMAN	360
Pinzas para chalazión DESMARRAS	722	Pinzas para iliaca COOLEY ATRAUMA	525	Pinzas para sujeción de huesos LOWMAN-HOGLUND ..	361
Pinzas para chalazión LAMBERT	722	Pinzas para intestino ALLIS	604	Pinzas para sujeción de huesos LOWMAN-LAMBERT ..	361
Pinzas para chalazión SNELLEN	721	Pinzas para intestino ALLIS-ADAIR	604	Pinzas para tabique ASCH	801
Pinzas para cilios	91	Pinzas para intestino ALLIS-BABY	604	Pinzas para tabique COTTLE-WALSHAM	801
Pinzas para cilios BARRAQUER	91	Pinzas para intestino BABCOCK	606	Pinzas para tabique KRESSNER	801
Pinzas para cilios BEER	91	Pinzas para intestino BABY-BABCOCK	606	Pinzas para tabique MIDDLETON-JANSEN	775
Pinzas para cilios DOUGLAS	90	Pinzas para intestino BABY-DOYEN	616	Pinzas para tabique RUBIN	775
Pinzas para cilios DOUGLAS	91	Pinzas para intestino BABY-DOYEN	608	Pinzas para tapones nasales HARTMANN	766
Pinzas para cilios FIG. 3,4,5,7	91	Pinzas para intestino BABY-DOYEN ATRAUMA	616	Pinzas para tapones nasales JANSEN (GRUENWALD) ..	766
Pinzas para cilios LITTAUER	90	Pinzas para intestino DOYEN	608	Pinzas para tapones nasales KILLIAN	767
Pinzas para cilios SHAAF	90	Pinzas para intestino DUVAL	607	Pinzas para tapones nasales LUBET-BARBON	766
Pinzas para coger tendones BRAND	440	Pinzas para intestino JUDD-ALLIS	605	Pinzas para tapones nasales TRÖLTSCH	766
Pinzas para coger tendones KLEINERT-KUTZ	441	Pinzas para intestino KOCHER	609	Pinzas para tapones nasales WESTMACOTT	766
Pinzas para coger tendones STEINMANN	440	Pinzas para intestino KOCHER ATRAUMA	617	Pinzas para tejidos	120
Pinzas para columella COTTLE	801	Pinzas para intestino LOCKWOOD-ALLIS	605	Pinzas para tejidos BOYS-ALLIS	605
Pinzas para conducto biliar BLAKE	634	Pinzas para intestino MAYO-ROBSON	609	Pinzas para tejidos TC-BABCOCK	606
Pinzas para conducto biliar CZERNY	634	Pinzas para intestino MAYO-ROBSON ATRAUMA	617	Pinzas para tejidos TC-DUVAL	607
Pinzas para conducto biliar MAYO-BLAKE	634	Pinzas para intestino THOMS-ALLIS	605	Pinzas para tracción craneal	545
Pinzas para conducto biliar MIXTER	635	Pinzas para intestino WILLIAMS	605	Pinzas para tubos	146,147
Pinzas para conducto biliar STILLE	635	Pinzas para intestino y estómago	610	Pinzas para tubos PRESBYTERIAN	146
Pinzas para conducto biliar TURNER-WARWICK	634	Pinzas para intestino y tejidos ALLEN	607	Pinzas para tumores CHAPUT	120
Pinzas para conducto biliar y cálculos renales	134,135	Pinzas para intestino y tejidos LITTLEWOOD	606	Pinzas para tumores HEIFETZ	93
Pinzas para cráneo WILLET-MARTEL	121	Pinzas para iris BISHOP-HARMAN	719	Pinzas para tumores LANDOLT	597
Pinzas para cuerpos extraños MATHIEU	645	Pinzas para iris GRAEFE	718	Pinzas para tumores SAMI	94
Pinzas para cutículas	855	Pinzas para iris STEVENS	718	Pinzas para tumores YASARGIL	93
Pinzas para derivación carotídea JAVID ATRAUMA	523	Pinzas para laminectomía CASPAR	595,596	Pinzas para tumores YASARGIL-SAMMII	93
Pinzas para desechos	886	Pinzas para laminectomía CUSHING	592	Pinzas para vasos periféricos ATRAUMA	
Pinzas para disección GRAY	133	Pinzas para laminectomía FERRIS-SMITH	599	SUBRAMANIAN	524
Pinzas para disección y para ligaduras	127-134	Pinzas para laminectomía LOVE-GRUENWALD	593	Pinzas para vasos periféricos DALE ATRAUMA	519
Pinzas para disección y para ligaduras GEMINI	129	Pinzas para laminectomía OLDBERG	597	Pinzas para vasos periféricos HUSFELDT ATRAUMA ..	521
Pinzas para disección y para ligaduras LAWRENCE	132	Pinzas para laminectomía SPURLING	594	Pinzas para vasos periféricos MARTIN ATRAUMA	520
Pinzas para disección y para ligaduras MEEKER	131	Pinzas para laringe MIKRO	841	Pinzas para vendajes GROSS-MAIER	148
Pinzas para disección y para ligaduras MINI-GEMINI ..	128	Pinzas para ligaduras DESJARDINS	133	Pinzas para vendajes y para algodón	148-151
Pinzas para disección y para ligaduras RUMEL	128	Pinzas para ligaduras KANTROWITZ	132	Pinzas para vendajes y	
Pinzas para entrelazar tendones	441	Pinzas para ligaduras KELLY	130	para algodón (sinusoidal) LISTER	149
Pinzas para escisión de prueba FAURE	680	Pinzas para ligaduras MIXTER-CRAFOORD	126	Pinzas para vendajes y para algodón BRYANT	149
Pinzas para escisión de prueba GELHORN	680	Pinzas para ligaduras OVERHOLT	127	Pinzas para vendajes y para algodón SIMS-MAIER ..	149

Pinzas PENNINGTON	120	Pinzas separadoras PRATT	673	Portaagujas MIKRO CASTROVIEJO	298-300
Pinzas planas para alambre	363-365	Pinzas separadoras SCHRÖDER	671	Portaagujas MIKRO CASTROVIEJO(JACOBSON)	299
Pinzas portaligaduras en forma de U MILLIN	638	Pinzas separadoras SCHROEDER	670	Portaagujas MIKRO TC-ARRUGA	312
Pinzas PRATT	121	Pinzas separadoras SKEENE	671	Portaagujas MIKRO TC-BOYNTON	312
Pinzas prensoras COLLIN	120	Pinzas separadoras STAUDE-MOORE	669	Portaagujas MIKRO TC-KALT	312
Pinzas prensoras COLLIN-DUVAL	87	Pinzas separadoras TEALE	671	Portaagujas MIKRO TC-SLIM	320
Pinzas prensoras DENIS-BROWNE	87	Pinzas TC	97-99	Portaagujas modelo resistente TC-HEGAR	319
Pinzas prensoras LESTER	720	Pinzas TC-DEBAKEY	99	Portaagujas NEIVERT	302
Pinzas prensoras MC GIVNEY	628	Pinzas TC-WANGENSTEEN	98	Portaagujas OLSEN-HEGAR	308
Pinzas prensoras MIKRO	600,601	Pinzas uterinas COLLIN	675	Portaagujas STRATTE	307
Pinzas prensoras MIKRO NICOLA	601	Pinzas uterinas DARTIGUES	675	Portaagujas TC-BABY-GILLIES	324
Pinzas prensoras MIKRO YASARGIL	601	Pinzas uterinas DOYEN	674	Portaagujas TC-BAUMGARTNER	318
Pinzas prensoras NELSON	87	Pinzas uterinas KELLY	674	Portaagujas TC-BOZEMANN	322
Pinzas prensoras para tumores TUFFIER	120	Pinzas uterinas SOMER	675	Portaagujas TC-CASTROVIEJO (JACOBSON)	313,314
Pinzas prensoras SINGLE-TUTTLE	87	Pinzas vasculares atraumática		Portaagujas TC-CONVERSE	317
Pinzas profunda GREGORY ATRAUMA	518	DEBAKEY	498, 499, 501-503	Portaagujas TC-CRILE	327
Pinzas PROVIDENCE-HOSPITAL	109	Pinzas vasculares BABY-SATINSKY	487	Portaagujas TC-CRILE-WOOD	320
Pinzas quirúrgicas	78-99	Pinzas vasculares BECK ATRAUMA	516	Portaagujas TC-CRILE-WOOD BABY	319
Pinzas quirúrgicas	81-87	Pinzas vasculares DARDIK ATRAUMA	522	Portaagujas TC-DEBAKEY	320
Pinzas quirúrgicas ADLERKREUTZ	83	Pinzas vasculares DERRA ATRAUMA	516	Portaagujas TC-DERF	316
Pinzas quirúrgicas ADSON	82	Pinzas vasculares GLOVER ATRAUMA	515	Portaagujas TC-DIETRICH	316
Pinzas quirúrgicas ADSON-BROWN	82	Pinzas vasculares HARKEN	488	Portaagujas TC-FINOCCHIETTO	323
Pinzas quirúrgicas BONNEY	86	Pinzas vasculares LELAND-JONES ATRAUMA	500	Portaagujas TC-GILLIES	324
Pinzas quirúrgicas BROPHY	84	Pinzas vasculares multiuso COOLEY ATRAUMA	526,527,528	Portaagujas TC-HALSEY	317
Pinzas quirúrgicas BROWN	86	Pinzas vasculares multiusos DEBAKEY	513,514	Portaagujas TC-MAYO-HEGAR VASCULAR	321
Pinzas quirúrgicas CUSHING	84	Pinzas vasculares para niños DEBAKEY	531	Portaagujas TC-HEPP-SCHIEDL	316
Pinzas quirúrgicas DUEHRSEN	85	Pinzas vasculares para recién nacidos		Portaagujas TC-HÖSEL	327
Pinzas quirúrgicas DURANTE	86	CASTANEDA ATRAUMA	535	Portaagujas TC-HÖSEL	328
Pinzas quirúrgicas DUVAL	87	Pinzas vasculares POTTS ATRAUMA	496-498,512	Portaagujas TC-KILNER	318
Pinzas quirúrgicas estándar	81	Pinzas vasculares POTTS-GLOVER ATRAUMA	498	Portaagujas TC-LANGENBECK	326
Pinzas quirúrgicas FERRIS-SMITH	85	Pinzas vasculares SATINSKY	488	Portaagujas TC-LICHTENBERG	327
Pinzas quirúrgicas GERALD	84	Pinzas VEIDENHEIMER ATRAUMA	620	Portaagujas TC-MASSON	323
Pinzas quirúrgicas GILLIES	83	Pinzas WEBER ATRAUMA	505	Portaagujas TC-MATHIEU	325,326
Pinzas quirúrgicas LANE	85	Pinzas WIRKSTROEM	132	Portaagujas TC-MATHIEU-KOCHER	325
Pinzas quirúrgicas LERCHE	83	Pinzas ZENKER	131	Portaagujas TC-MATHIEU-RYDER	326
Pinzas quirúrgicas MIKRO ADSON	82	Pistola de limpieza completa AQUAJET	878	Portaagujas TC-MAY-HEGAR-SLENDER PATTERN	319
Pinzas quirúrgicas MOD. RUSSO	86	Placa de sujeción para las puntas de tubos		Portaagujas TC-MAYO-HEGAR (HEANEY)	319
Pinzas quirúrgicas MOD. USA	82	para tunelar	538	Portaagujas TC-MAYO-HEGAR-HEAVY PATTERN	319
Pinzas quirúrgicas POTTS-SMITH	84	Placa de sujeción suelta	11	Portaagujas TC-NEIVERT	317
Pinzas quirúrgicas RAMSEY	86	Placa para párpado JAEGER	705	Portaagujas TC-OLSEN-HEGAR MINI	324
Pinzas quirúrgicas SEMKEN	83	Placa protectora	760	Portaagujas TC-RYDER MINI	321
Pinzas quirúrgicas STILLE	82	Placas límite con ranura	372	Portaagujas TC-RYDER-FRENCH EYE	320
Pinzas quirúrgicas STILLE-BARRAYA	85	Pólipo nasal con enlaces KRAUSE-VOSS	765	Portaagujas TC-SAROT	322
Pinzas quirúrgicas STONE	83	Portaagujas ADSON	303	Portaagujas TC-SENNING	322
Pinzas quirúrgicas TAYLOR	83	Portaagujas ARRUGA	295	Portaagujas TC-STRATTE	323
Pinzas quirúrgicas TC-ADSON	98	Portaagujas BABY-GILLIES	308	Portaagujas TC-TOENNIS	327
Pinzas quirúrgicas TC-ADSON-BROWN	98	Portaagujas BARRAQUER	296-297	Portaagujas TC-WANGENSTEEN	323
Pinzas quirúrgicas TC-BONNY	99	Portaagujas BARRAQUER-TROUTMAN	296	Portaagujas TC-WEBSTER	317
Pinzas quirúrgicas TC-FERRIS-SMITH	99	Portaagujas BAUMGARTNER	302	Portaagujas TC-YASARGIL	315
Pinzas quirúrgicas TC-GILLIES	99	Portaagujas BROWN	302	Portaagujas TC-ZWEIFEL	328
Pinzas quirúrgicas TC-OEHLER	99	Portaagujas COLLIER	301	Portaagujas TOENNIS	309
Pinzas quirúrgicas TC-SEMKEN	99	Portaagujas CRILE MURRAY	303	Portaagujas WANGENSTEEN	306
Pinzas quirúrgicas TC-TREVES	86	Portaagujas CRILE WOOD	303	Portaagujas WEBSTER	301
Pinzas quirúrgicas WAUGH	85	Portaagujas curvado TC-BARRAQUER	314,315	Portaagujas YASARGIL	358
Pinzas RANKIN-DEBAKEY ATRAUMA	493	Portaagujas DERF	301	Portaalgodón FARRELL	229
Pinzas rectal FEHLAND ATRAUMA	620	Portaagujas FINOCCHIETTO	306	Portaalgodones FEIN	229
Pinzas rectales RESANO ATRAUMA	621	Portaagujas GILLIES	308	Portaalgodones JOBSON-HORNE	229
Pinzas RICHTER-HEATH	338	Portaagujas GOMEL	297	Portaalgodones PELTESON	229
Pinzas ROBERTS	125	Portaagujas HALSEY	302	Portabrocas con mango en T completo	358
Pinzas ROCHESTER-CARMALT	122	Portaagujas HALSEY	302	Portabrocas para alambre DEMEL	369
Pinzas sacabocado para seno maxilar CITELLI	777	Portaagujas HEANEY	305	Portacuchillas TROUTMANN-CHRIS	14
Pinzas sacabocado para seno maxilar KERRISON	777	Portaagujas HEGAR	307	Portaespátulas LEYLA	549
Pinzas sacabocado para seno maxilar STAMMBERGER	772	Portaagujas JAMISON	305	Portaespátulas LEYLA	550
Pinzas SAROT	126	Portaagujas JOHNSON	306	Portafolio de luz de repuesto	285
Pinzas SCHNIDT	124	Portaagujas KALT	295	Portapinzas DE MARTEL-WOLFSON	614
Pinzas SCUDDER ATRAUMA	618	Portaagujas LICHTENBERG	309	Proctoscopio KELLY	626
Pinzas separadoras BARRET	669	Portaagujas MASS-GENERAL-HOSPITAL	303	Protector para pinzas para tabique RUBIN	775
Pinzas separadoras BRAUN	670	Portaagujas MASSON	305	Punta COUPLAND	239
Pinzas separadoras BRAUN	674	Portaagujas MATHIEU	309	Punta de pinzas para	
Pinzas separadoras CZERNY	674	Portaagujas MATHIEU-KOCHER	309	biopsia MINI-TOWNSEND (BABY-TISCHLER)	684
Pinzas separadoras DUPLAY	671	Portaagujas MATHIEU-RYDER	309	Punta de repuesto	545
Pinzas separadoras JACOBS	672	Portaagujas MAYO-HEGAR	304	Punta de sonda de plástico NABATOFF	227
Pinzas separadoras JARCHO	669	Portaagujas MAYO-HEGAR	307	Punta para biopsia KEVORKIAN	684
Pinzas separadoras MUSEUX	672	Portaagujas METZENBAUM	303	Punta para biopsia SCHUMACHER	685
Pinzas separadoras POZZI	670	Portaagujas MIKRO	296-300		

Inhaltsverzeichnis
Alphabetical Index
Indice alfabético
Indice alfabetico

Punta para biopsia TISCHLER-MORGAN 684
Punta para biopsia TOWNSEND 684
Punta para biopsia TOWNSEND-MINI (BABY-TISCHLER) 684
Punzón con mango de ferrozell 386
Punzón con mango de metal 386
Punzón de cápsulas HOLTH 715
Punzón de hueso esfenoidal HAJEK 776
Punzón de hueso esfenoidal HAJEK-KOFLER 776
Punzón para laminectomía FERRIS-SMITH-KERRISON 591
Punzón para laminectomía LOVE-KERRISON 582
Punzón para laminectomía, no desmontable KERRISON 577-598

R

Recipiente para placenta 877
Recipiente para vómitos 876
Rectoscopio FANSLER 626
Rectoscopio HIRSCHMANN 625
Rectoscopio IVES-FANSLER 625
Retractor 154-194
Retractor 155
Retractor abdominal BABY-BALFOUR 215
Retractor abdominal COLLIN 212
Retractor abdominal DENIS-BROWNE 220
Retractor abdominal DOYEN 176
Retractor abdominal FRANZ 221
Retractor abdominal GOSSET 215
Retractor abdominal KIRSCHNER 218,219
Retractor abdominal O'CONNOR SULLIVAN 218
Retractor abdominal RICARD 214
Retractor abdominal ROBIN-MASS 214
Retractor abdominal SEMM 220
Retractor abdominal tipo BALFOUR US 216
Retractor ADSON 198,203,204
Retractor ADSON 205
Retractor ADSON 559
Retractor ALLPORT 197
Retractor ALM 197
Retractor ANDERSON-ADSON 198
Retractor BABY-ROUX 192
Retractor BRUNNER 179-181
Retractor CLOWARD 210,211
Retractor COLLIN 194
Retractor COLLIN-LOKTITE 212
Retractor completo BABY-COLLIN 212
Retractor COOLEY 186
Retractor CORYLLOS 178
Retractor CRILE 194
Retractor CUSHING 159-161
Retractor CUSHING 559
Retractor DAVIDSON 178
Retractor de aorta CRAWFORD 182
Retractor de aorta ROSS 182
Retractor de laminectomía BADGLEY 568
Retractor de laminectomía CASPAR 571
Retractor de mejillas 815
Retractor de párpados BARRAQUER (COLIBRI) 704
Retractor de párpados CASTROVIEJO 704
Retractor de párpados DESMARRES 705
Retractor de párpados MELLINGER 704
Retractor de SCHUKNECHT 201
Retractor de vejiga JUDD-MASSON 639
Retractor DEEVER 185-187
Retractor DESMARRES 156
Retractor DOYEN-SILENT 175
Retractor esternal MORSE 483
Retractor esternal MORSE-FAVALORO 483
Retractor FARABEUF 191
Retractor FOMON 799
Retractor FRAZIER 559
Retractor FRITSCH 176
Retractor GELPI 209

Retractor GELPI-LOKTITE 209
Retractor GOELET 193
Retractor GRAEFE 154
Retractor GRAHAM 559
Retractor GUTHRIE 154
Retractor HARRINGTON 184
Retractor HENLEY 202
Retractor HÖSEL 197
Retractor HÖSEL 175
Retractor ISRAEL 167
Retractor JANSEN 197
Retractor JOLL (FRIEDMAN) 208
Retractor JOLL (FRIEDMANN) 208
Retractor KELLY 174,189
Retractor KNAPP 156
Retractor KOCHER 164,165
Retractor KOCHER 172
Retractor KOCHER 173
Retractor KOCHER 176
Retractor KOCHER-LANGENBECK 170
Retractor KOERTE 166
Retractor LAHEY 169
Retractor LANGENBECK 167,168,196
Retractor LANGENBECK-GREEN 158
Retractor LITTLE 169
Retractor LUER 194
Retractor MARTIN 177
Retractor MATHIEU 193
Retractor MAYO-ADAMS 208
Retractor MEYERDING 157,185
Retractor MEYERDING 185
Retractor MIDDELDORPF 173,176
Retractor MINI-LANGENBECK 156
Retractor MINI-ROUX 192
Retractor MOLLISON 200
Retractor MORRIS 184
Retractor NORFOLK AND NORWICH 207
Retractor O'CONNOR 154
Retractor OBWEGESER 819
Retractor OLLIER 166
Retractor para amputación PERCY 355
Retractor para cuello vesical MILLIN 638
Retractor para duramadre CASPAR 560
Retractor para duramadre KRAYENBÜHL 560
Retractor para elevador BOWMAN 704
Retractor para elevador MELLINGER-AXENFELD 704
Retractor PARKER 192
Retractor PARKER-LANGENBECK 193
Retractor pélvico ST. MARKS 189
Retractor PLESTER 200
Retractor POLLOSOS 183
Retractor quirúrgico 196-217
Retractor quirúrgico BUCKLEY 196
Retractor quirúrgico FINSEN 196
Retractor quirúrgico LOGAN 196
Retractor RAGNELL 158
Retractor RAGNELL-DAVIS 158
Retractor RICHARDSON 174
Retractor RICHARDSON-EASTMAN 174
Retractor RICHTER 207
Retractor RIGBY 208
Retractor ROUX 191
Retractor SACHS 559
Retractor SAUERBRUCH 171,178
Retractor SAUERBRUCH 178
Retractor SCALP-CONTOUR 198
Retractor SENN-MILLER 159
Retractor SIMON 177
Retractor STRANDELL-SILENT 161
Retractor tipo GIL-VERNET 161
Retractor vesical IOWA 672
Retractor vesical LEGUE 640
Retractor vesical MILLIN 639
Retractor VOLKMANN 162-164
Retractor WASSMUND 166

Retractor WEITLANER 199
Retractor WEITLANER-LOKTITE 198
Retractor ZENKER 172
Retractores BECKMANN 205
Retractores BECKMANN-ADSON 206
Retractores BECKMANN-EATON 206
Retractores COLLIN 338
Retractores MICHEL 339
Retractores para fijación craneal 549
Retractores para la fijación en mesa de operaciones 551
Rociador de instrumentos 880

S

Sacacomedones KATSCH 852
Sacacomedones SAALFELD 852
Sacacomedones SCHAMBERG 852
Sacacomedones UNNA 852
Sacacomedones UNNA-VIDAL 852
SALENIUS 437
Salpingógrafo SCHULTZE 694
SATINSKY 487, 488
Separador anal ALAN-PARKS 625
Separador anal SMITH-BUIE 624
Separador de costillas BAILEY-GIBBON 485
Separador de costillas de BAILEY 485
Separador de menisco SMILLIE 435
Separador espinal TAYLOR 434
Separador MERCEDES 484
Separador nasal 797
Separador nasal COTTLE 800
Separador nasal COTTLE-NEIVERT 799
Separador nasal FOMON 797
Separador nasal KILNER 800
Separador nasal KILNER 798
Separador para heridas y meniscos 434,435
Separador para heridas y rodilla BLOUNT 434
Separador torácico MERCEDES 484
Separadores de cuerpos vertebrales CLOWARD 576
Separadores de cuerpos vertebrales INGE 576
Separadores para duramadre DANDY 556
Separadores para duramadre FRAZIER 556
Separadores para duramadre HORSLEY 556
Separadores para duramadre MILLIGAN 556
Separadores para duramadre SACHS 556
Separadores para la raíz del nervio CUSHING 555
Separadores para la raíz del nervio GRONINGEN 555
Separadores para la raíz del nervio HOLSHER 554
Separadores para la raíz del nervio LOVE 554
Separadores para la raíz del nervio SCOVILLE 554
Separadores para labios y mejillas CAWOOD-MINNESOTA 815
Separadores para labios y mejillas STERNBERG 815
Separadores para próstata YOUNG 637
Separadores vesicales KOCHER 640
Separadores vesicales LEGUE 640
Separadores y pinzas cortantes para seno maxilar
SIEBENMANN 805
Servilletero ADAMS 808
Set completo LEYLA 549
Sierra de alambre GIGLI 544
Sierra de alambre OLIVECRONA 544
Sierra de amputación BIER 352
Sierra de amputación CHARRIERE 353
Sierra de amputación RUST 352
Sierra de amputación SATTERLEE 353
Sierra de anillo MARTIN 469
Sierra de anillo WALTON 469
Sierra LANGENBECK 353
Sierra nasal JOSEPH 791
Sierra para yeso BERGMANN 348
Sierra para yeso ENGEL 348
Sierra para yeso oscilante 350
Sonda abotonada 224
Sonda BRODIE 225
Sonda conductora 334

Sonda conductora BRUNNER	334
Sonda conductora de ferrozell	336
Sonda conductora de ferrozell BRUNNER	336
Sonda conductora de ferrozell KIRSCHNER	336
Sonda conductora KIRSCHNER	334
Sonda conductora KÖNIG	334,335
Sonda conductora PAYR	335
Sonda conductora SCHMIEDEN	335
Sonda conductora SCHMIEDEN-PAYR	335
Sonda de dilatación RITTER-HALLE	805
Sonda de hoja de mirto	224
Sonda de medición MIKRO HOUSE	738
Sonda de tracción de tendones BUNNELL	439
Sonda deslizante FILIFORM	641
Sonda doble JACOBSON	562
Sonda hueca	224,225
Sonda hueca con botón	225
Sonda hueca DOYEN	225
Sonda hueca LOCKHARD-MUMMERY	225,226
Sonda hueca NELATON	225
Sonda MAYO	633
Sonda ocular BOWMAN	716
Sonda para bocio KOCHER	849
Sonda para el conducto biliar DESJARDINS	633
Sonda STACK	224
Sonda trabecular HARMS	716
Sonda UCKERMANN	229
Sonda y cucharilla para el conducto biliar	
MOYNIHAN	633
Sondas	224
Soplador de polvo completo KABERSKE	757
Soplador de polvo UNIVERSAL	757
Soporte abdominal	212-222
Soporte de cráneo CRUTCHFIELD	545
Soporte de pecho con soporte de laringoscopio	284
Soporte de techo REICHERT	840
Soporte KALLMORGEN	658
Soporte KRISTELLER	653-657
Soporte MARTIN-VICKERS	467
Soporte MATHIEU	659
Soporte MC KENZIE	547
Soporte para 12 espéculos para oído	741
Soporte para barbilla OBWEGESER	821
Soporte para cepillos de dientes	875
Soporte para el pecho	284
Soporte para progeñie OBWEGESER	821
Soporte pectoral NEGUS	810
SUBRAMANIAN-MINIATUR ATRAUMA	524
Succión	760
T	
Taladro de mano BUNELL	359
Taladro de mano RALK	359
Taladro de mano STILLE	357
Taladro para dedos y uñas de los pies MARTIN-IDEAL	468
Tamponeador LUNIATSCHEK	833
Tapa con perilla para el orinal	876
Tapa de la papelera	886
Tapa para el recipiente para vomitos	876
Tapas de sustitución hecha de ferrozell	401
Taza de medicamentos	874
Tazón de lavado	870
Tazón del fregadero	870
Tazón giratorio	872
Tazón redondo	869
Tazón redondo para mezclar	869
Tenazas para desecho SAUERBRUCH	886
Tensor de alambre LOUTE	369
Tijeras	22-75
Tijeras BOETTCHER	46
Tijeras BRAUN-STADLER	29
Tijeras BROPHY-SULLIVAN	36
Tijeras corneales CASTROVIEJO	726
Tijeras COTTLE	47
Tijeras CRAFOORD	41
Tijeras DANDY	45
Tijeras de alambre BEEBEE	50
Tijeras de enucleación	34
Tijeras de episiotomía	29
Tijeras de episiotomía SUPERCUT WALDMANN	69
Tijeras de episiotomía WALDMANN	29
Tijeras de ginecología con hojas de metal duro	61
Tijeras de ginecología TC-WERTHEIM	61
Tijeras de hilo EISELSBERG	52
Tijeras de histerectomía TC-PARAMETRIUM	61
Tijeras de incisión	25
Tijeras de iridectomía BARRAQUER	725
Tijeras de iridectomía CASTROVIEJO	723,724
Tijeras de iridectomía MOD.TÜBINGEN VANNAS	725
Tijeras de iridectomía NOYES	724
Tijeras de iridectomía VANNAS	725
Tijeras de iridectomía WESTCOTT	724
Tijeras de vendaje BERGMANN	345
Tijeras de vendaje EXCENTRIC	344
Tijeras DEAN	48
Tijeras DEAVER	25
Tijeras DOYEN	27
Tijeras DUBOIS	28
Tijeras Dura FORGE-TAYLOR	45
Tijeras estándar SUPERCUT	66
Tijeras GOLDMANN-FOX	49
Tijeras HEYMANN	47
Tijeras JOSEPH	35
Tijeras KELLY	48
Tijeras KILNER	35
Tijeras LA GRANGE	49
Tijeras LANDOLT	35
Tijeras LEXER	32
Tijeras LEXER SUPERCUT	68
Tijeras LEXER-BABY	32
Tijeras LEXER-FINO	33
Tijeras LOCKLIN	48
Tijeras MAYO	25
Tijeras MAYO-HARRINGTON	26
Tijeras MAYO-NOBLE	27
Tijeras MAYO-STILLE	26
Tijeras METZENBAUM	30
Tijeras METZENBAUM-FINO	33,34
Tijeras METZENBAUM-FINO S	34
Tijeras METZENBAUM-NELSON	31
Tijeras MIKRO	16-19
Tijeras MIKRO GOMEL	17
Tijeras MIKRO HEPP-SCHEIDEL	17,19
Tijeras MIKRO JACOBSON	16
Tijeras MIKRO NICOLA	601
Tijeras MIKRO POTTS	16
Tijeras MIKRO REIL	19
Tijeras MIKRO WESTCOTT	17
Tijeras MOD. BONN	38
Tijeras nasales	774
Tijeras nasales CAPLAN	775
Tijeras nasales Fomon	47
Tijeras nasales KIRSTEIN	47
Tijeras nasales MIKRO	774
Tijeras NEUMANN	49
Tijeras O'BRIAN	38
Tijeras OLIVECRONA	46
Tijeras para cordón umbilical BUSCH	29
Tijeras para cordón umbilical SCHUMACHER	29
Tijeras para costillas GLUCK	472
Tijeras para costillas y esternón BRUNNER	473
Tijeras para disección FOMON	34
Tijeras para disección JAMESON	39
Tijeras para disección SUPERCUT JAMESON	74
Tijeras para el cordón umbilical MOD. USA	29
Tijeras para esternón GIERTZ-STILLE	472
Tijeras para esternón SAUERBRUCH	472
Tijeras para estrabismo	38
Tijeras para estrabismo SUPERCUT	68
Tijeras para intestino	51
Tijeras para iris	37
Tijeras para iris SUPERCUT	72
Tijeras para iris TC	62
Tijeras para la preparación de nervios	32
Tijeras para ligaduras BUCK	52
Tijeras para ligaduras HEATH	52
Tijeras para ligaduras LITTAUER	52
Tijeras para ligaduras NORTHBENT	52
Tijeras para ligaduras SPENCER	52
Tijeras para oído MIKRO BELLUCCI	731
Tijeras para oído MIKRO WULLSTEIN	731
Tijeras para ojos CASTROVIEJO	723
Tijeras para ojos KATZIN-BARRAQUER	723
Tijeras para ojos MIKRO	723
Tijeras para ojos MIKRO AEBLI	723
Tijeras para recto FINOCHIETTO	42
Tijeras para recto RESANO	42
Tijeras para uñas	853
Tijeras para uñas TURNBULL	854
Tijeras para vendajes ESMARCH	346
Tijeras para vendajes KNOWLES	344
Tijeras para vendajes LISTER	342-344
Tijeras para vendajes LORENZ	345
Tijeras para vendajes SEUTIN	347
Tijeras para vendajes SUPERCUT LISTER	75
Tijeras para yeso BRUNS	346
Tijeras para yeso STILLE	347
Tijeras pequeñas METZENBAUM	30
Tijeras PRINCE	46
Tijeras QUINBY	49
Tijeras quirúrgicas estándar	22-23
Tijeras quirúrgicas finas	24
Tijeras quirúrgicas finas	40
Tijeras quirúrgicas finas	36-40
Tijeras rectales	42
Tijeras REYNOLDS	39
Tijeras SANVENERO	36
Tijeras SIEBOLD	28
Tijeras SIMS	28
Tijeras STEVENS	38
Tijeras STRULLY	45
Tijeras SUPERCUT	66-75
Tijeras SUPERCUT COTTLE	70
Tijeras SUPERCUT FOMON	70
Tijeras SUPERCUT FREEMANN-GORNEY	75
Tijeras SUPERCUT FREEMANN-KAYE	75
Tijeras SUPERCUT GOLDMANN-FOX	73
Tijeras SUPERCUT GORNEY	74
Tijeras SUPERCUT HEYMANN	70
Tijeras SUPERCUT JOSEPH	72
Tijeras SUPERCUT KAYE FACE LIFT	74
Tijeras SUPERCUT KELLY	72
Tijeras SUPERCUT MAYO	66
Tijeras SUPERCUT MAYO-STILLE	66
Tijeras SUPERCUT METZENBAUM	67
Tijeras SUPERCUT METZENBAUM-FINO	68
Tijeras SUPERCUT METZENBAUM-NELSON	67
Tijeras SUPERCUT REYNOLDS	73
Tijeras SUPERCUT SIEBOLD	69
Tijeras SUPERCUT SIMS	69
Tijeras SUPERCUT STEVENS	73
Tijeras SUPERCUT WAGNER	72
Tijeras TC	54-64
Tijeras TC-BRUNS	346
Tijeras TC-DEBAKEY	60
Tijeras TC-GOLDMAN-FOX	63
Tijeras TC-JOSEPH	62
Tijeras TC-KELLY	62
Tijeras TC-LEXER	56
Tijeras TC-LISTER	342
Tijeras TC-LOCKLIN	63
Tijeras TC-MAYO	55
Tijeras TC-MAYO-HARRINGTON	61

Inhaltsverzeichnis
Alphabetical Index
Indice alfabético
Indice alfabetico

Tijeras TC-MAYO-LEXER 55
Tijeras TC-MAYO-STILLE 55
Tijeras TC-METZENBAUM. 56,57
Tijeras TC-METZENBAUM-FINO 57-58
Tijeras TC-METZENBAUM-FINO S 58-59
Tijeras TC-RAGNELL (KILNER) 64
Tijeras TC-SIMS 61
Tijeras TC-STANDARD 54
Tijeras TC-TOENNIS-ADSON 59
Tijeras THOREK 34
Tijeras tipo SUPERCUT PAR. 74
Tijeras UNIVERSAL 50
Tijeras universales TC 64
Tijeras uterinas BOZEMANN 28
Tijeras vasculares DE BAKY 44
Tijeras vasculares DEBAKEY 44
Tijeras vasculares DIETRICH 43
Tijeras vasculares FAVALORO 45
Tijeras vasculares GOOD 46
Tijeras vasculares KLINGENBERG-LOTH 41
Tijeras vasculares LLOYD-DAVIS 41
Tijeras vasculares MC INDOE 45
Tijeras vasculares POTTS DE MARTEL 44
Tijeras vasculares POTTS-SMITH 44
Tijeras vasculares SATINSKY 41
Tijeras vasculares STELZNER 41
Tijeras vasculares SUPERCUT DIETRICH 71
Tijeras vasculares SUPERCUT POTTS-SMITH 71
Tijeras vasculares SUPERCUT TOENNIS-ADSON 69
Tijeras vasculares TOENNIS 46
Tijeras vasculares TOENNIS-ADSON 46
Tijeras WAGNER 39
Tijeras WERTHEIM 27
Tonómetro SCHIOETZ 704
Torniquete ESMARCH 355
Torniquete flexible RUMEL-BELMONT 541
Transformador pequeño para la linterna frontal 262
Transportador MOELTGEN 253
Trefinas corneales estuche completo ELLIOT 714
Trépano ELLIOT 714
Trépano STILLE 357
Triturador de cuchillas 14
Triturador y soporte de cuchillas CASTROVIEJO 14
Trocar AntrumPIERCE 231
Trocar BULEAU 231
Trocar DOUGLAS 231
Trocar estándar 230
Trócar KRAUSE 231
Trócar LANDAU 232
Trocar LICHTWITZ 231
Trocar NELSON 230
Trocar OCHSNER 231
Trocar para mandíbula COAKLEY 232
Trocar traqueal UECKERMANN 843
Trocar UNIVERSAL 230
Tubo de aspiración ADSON 232
Tubo de aspiración ANDREWS-PYNCHON 238
Tubo de aspiración COGSWELL 234
Tubo de aspiración completo MIKRO BELLUCCI 235
Tubo de aspiración COOLEY 239
Tubo de aspiración FRAZIER 232
Tubo de aspiración LEMPERT 233
Tubo de aspiración MAGILL 235
Tubo de aspiración PLESTER 233,234
Tubo de aspiración POOLE 238
Tubo de aspiración POPPEN 233
Tubo de aspiración YANKAUER 238
Tubo de aspiración YASARGIL 237
Tubo de extensión BRUENINGS 836
Tuerce-lazos BOZEMANN 336
Tunelizador 538

U

Unidad de perforación HUDSON 358
Uretrotomo OTIS 643
USA MOD. Cucharilla afilada MOD. USA 406

V

Valva CASPAR 571
Valva central ALAN-PARKS 625
Valva central BALFOUR 217
Valva central COLLIN 213
Valva central GOSSET 215
Valva central HENLEY 202
Valva central JUDD-MASSON 639
Valva central LEGUE 640
Valva central MILLIN 639
Valva central RICARD 213
Valva central ROBIN-MASS 213
Valva de fijación suelta 760
Valva de hilo pequeña BALFOUR 217
Valva DENIS-BROWNE 220
Valva FRANZ 221
Valva lateral ALAN-PARKS 625
Valva lateral CASPAR 569,570,574
Valva lateral COLLIN 213
Valva lateral de DEBAKEY 481,482
Valva lateral MERCEDES 484
Valva lateral MILLIN 639
Valva lateral para retractor SCOVILLE 566,567
Valva lateral para retractores TAYLOR 567
Valva lateral RICARD 213
Valva SCHERBAK 660
Valva SEMM 220
Valvas DOYEN 221
Valvas FRANZ 221
Valvas KIRSCHNER 219
Valvas KIRSCHNER-BALFOUR 219
Valvas laterales LEGUE 640
Valvas ROCHARD 222
Válvula de tres vías LUER-LOCK 244
Varilla de medición 255
Varilla de medición de rayos X 255
Varios bisturis para ojos 707
Vaso de esputo con tapa abatible 875
Vaso de medición 869

W

WEITLANER-BABY 201
WEITLANER-WULLSTEIN 200

A			
Abbassalingua	817	Asta di misurazione a raggi X	255
Abbassalingua ANDREW	816	Attacco con filettatura conica	760
Abbassalingua BRUENINGS	817	Attacco per aspirazione	760
Abbassalingua BUCHWALD	817	Attacco, a forma di oliva	760
Abbassalingua DINGMANN	813		
Abbassalingua HARTMANN	816	B	
Abbassalingua in legno	817	Bacinella	870
Abbassalingua in plastica	817	Banda FELDHEIM	468
Abbassalingua MC IVOR	812	Battitore con manico in Ferroccl	386
Abbassalingua TOBOLD	816	Battitore con manico in metallo	386
Abbassalingua WIEDER	816	Bisturi a lancia JAEGER-GRIESHABER	706
Accessori a vite per set per tunneling	538	Bisturi a stella GRAEFFE	706
Accessori per divaricatori LEYLA	550	Bisturi ad anello BARNHILL	803
Accessori per divaricatori LEYLA	553	Bisturi ad anello BECKMANN	802,803
Adattatore a vite LUER	538	Bisturi ad anello LA FORCE	804
Aghi per legatura	329-334	Bisturi ad anello ST.CLAIR-THOMSON	804
Aghi per occhi Ob	291	Bisturi circolare SCHUKNECHT	734
Aghi per occhi Og	291	Bisturi di ricambio DAHLGREN	546
Aghi REDON	240	Bisturi di ricambio DE VILBISS	546
Ago auricolare BARBARA	736	Bisturi falciforme auricolare WULLSTEIN	734
Ago auricolare ROSEN	735	Bisturi falciforme SCHUKNECHT	734
Ago auricolare ROSEN	736	Bisturi oftalmico KNAPP	706
Ago chirurgico	288-290	Bisturi oftalmico ZIEGLER	707
Ago chirurgico curvo B	288	Bisturi per amputazione	12,13
Ago chirurgico curvo E	289	Bisturi per amputazione CATLIN	12
Ago chirurgico curvo G	288	Bisturi per amputazione COLIN	12
Ago chirurgico curvo Ga	289	Bisturi per amputazione LANGENBECK	13
Ago chirurgico curvo Gr	289	Bisturi per amputazione LISTON	12
Ago chirurgico per intestino KEITH	290	Bisturi per apparecchi gessati ESMARCH	348
Ago chirurgico per intestino Pb	290	Bisturi per apparecchi gessati HOPKINS	348
Ago chirurgico per intestino Pc	290	Bisturi per apparecchi gessati REINER	348
Ago chirurgico per intestino Pd	290	Bisturi per cartilagine VIRCHOW	3
Ago di ricambio YOUNG	330	Bisturi per conizzazione AYRE	2
Ago guida per filo	370	Bisturi per dissezione	3
Ago guida per filo DEMEL	370	Bisturi per dura madre HALL	560
Ago guida per filo DEMEL	370	Bisturi per dura madre TOENNIS	560
Ago KRONECKER	331	Bisturi per lobuli PLESTER	734
Ago per dissezione BOWMAN	707	Bisturi per menisco	436,437
Ago per legatura BRUNNER	333	Bisturi per menisco BIRCHER	436
Ago per legatura COOPER	331	Bisturi per menisco NEFF	437
Ago per legatura DESCHAMPS	332,333	Bisturi per miomi SEGOND	2
Ago per legatura SCHMIEDEN	330	Bisturi per organi WALB	4
Ago per legatura SCHMIEDEN-DICK	330	Bisturi per rinoplastica CONVERSA	778
Ago per occhi	291	Bisturi per rinoplastica COTTLE	778
Ago per procedure vascolari KALT	291	Bisturi per rinoplastica FOMON	778
Ago per procedure vascolari PAYR	291	Bisturi per rinoplastica JOSEPH	778
Ago per timpano LUCAE	755	Bisturi per rinoplastica JOSEPH	778
Ago per timpano POLITZER	755	Bisturi per setto BRUENINGS completo	781
Ago per tonsille DUPUY BIANCO	829	Bisturi per setto FREER	779
Ago per tonsille HURD	829	Bisturi per tonsille ABRAHAM	830
Ago REVERDIN	329	Bisturi per tonsille BRUENINGS	830
Agrafes KÖLNER	548	Bisturi per tonsille FISCHER	830
Agrafes MICHEL	339	Bisturi VIRCHOW	4
Alesatore per Chrutchfield	545	Bisturi/dissettore per tonsille CARPENTER	831
Amniotomo BEACHAM	671	Boccale	875
Anelli in gomma per legatore per emorroidi	627	BONN MOD. Forbici	38
Anello di tenuta	693	BONN MOD. Pinzetta Iris	719
Ansa per corpo estraneo standard	708	Bougie per uretra GUYON	641
Ansa per orecchio BILLEAU	753	Bougie per uretra VAN BUREN	641
Ansa per orecchio WEBER-LOCH	753	Bracciale braccio per tourniquet emostatico	354
Ansa WEBER	712	Bracciale con velcro	264
Anse per serranodo auricolare	746	Bracciale gamba per tourniquet emostatico	354
Anse per serranodo per polipi nasali	765	Braccio di supporto per fissaggio LEYLA	551,552
Anse per tonsille	835	Braccio mobile LEYLA, flessibile	549
Applicatore per morsetto bulldog	491		
Applicatore per morsetto bulldog TITAN	104	C	
Applicatori ed estrattori RANEY	548	Calibro	254
Apribocca MAUNDER	808	Calibro JAMESON con scala graduata	254
Apribocca PITHA	808	Calibro oftalmico CASTROVIEJO	715
Aspiratore nasale KILNER	234	Cannula BIER	242
Aspiratore per dissezione LANDOLT	234	Cannula CASTROVIEJO	714
Assordatore BARANY con oliva auricolare	745	Cannula IOWA	240
Asta di misurazione	255	Cannula KLIMA-ROSSEGER	243
		Cannula KNUTSON-KOCH	644
		Cannula LUER LOCK	714
		Cannula MENGHINI	241
		Cannula per aspirazione BARRON	236
		Cannula per aspirazione HOUSE	236
		Cannula per aspirazione SCHUKNECHT	236
		Cannula per aspirazione ZÖLLNER	236
		Cannula per insufflazione VERRES	242
		Cannula per irrigazione nasale EICKEN-KILLIAN	805
		Cannula per irrigazione vascolare SCHMID	242
		Cannula per orecchio KABERSKE	757
		Cannula per puntura lombare TUOHY	242
		Cannula QUINKE	241
		Cannula tracheale CHEVALIER-JACKSON	846
		Cannula tracheale LUER	846
		Cappuccio di protezione per pinze per setto RUBIN	775
		Catena con peso DOYEN	221
		Catena, solo per set da infermiera	853
		Catetere auricolare HARTMANN	746
		Catetere GUYON	644
		Catetere in metallo per donna	642
		Catetere in metallo per uomo	642
		Catetere per irrigazione del seno mascellare SIEBENMANN	805
		Catino	870
		Cesoia per ossa BÖHLER	463
		Cesoia per ossa CLEVELAND	462
		Cesoia per ossa COTTLE-KAZANJIAN	462
		Cesoia per ossa LISTON	461
		Cesoia per ossa LISTON-KEY	466
		Cesoia per ossa MARKWALDER	462
		Cesoia per ossa MC INDOE	463
		Cesoia per ossa RUSKIN	463
		Cesoia per ossa SEMB	466
		Cesoia per ossa STILLE-LISTON	464,465
		Cestello per immersione per sterilizzazione	867
		Cestello per sterilizzazione	868
		Cestino per cotone idrofilo usato METHOT	875
		Chiave a vite per set per tunneling	538
		Chiave dinamometrica	350
		Chiave girevole CASPAR, da sola	569
		Chiodo STEINMANN	373
		Cilindro di punzonatura	872
		Cilindro JANET	246
		Ciotola rotonda	869
		Ciotola rotonda per miscelare	869
		Cistotomo GRAEFFE	708
		Clip e applicatori MC KENZIE	547
		Clip e applicatori OLIVECRONA-TOENNIS	547
		Compasso di misurazione per cranio BERTILLON	253
		Cono di inserimento POLITZER con piastra di copertura	758
		Cono per carica per legatore per emorroidi	627
		Contentore in metallo per set per tunneling	538
		Contentore interno, coperchio e base	294
		Contentore metallico NABATOFF	227
		Contentore per aghi	292-294
		Contentore per espettorato con coperchio a cerniera	875
		Contentore per lo smaltimento degli spazzolini	860
		Contentore per medicina	874
		Coperchio con incavo triangolare	872
		Coperchio con pomello per padella	876
		Coperchio per pattumiera	886
		Coperchio per vassoio a forma di rene	876
		Coperchio, da solo	872
		Cranioclasto BRAUN	701
		Cranioclasto TARNIER	701
		Cucchiaio con doppio attacco MARTINI	409
		Cucchiaio con doppio attacco WILLIGER	409
		Cucchiaio e uncino per orecchio GROSS	752
		Cucchiaio ostetrico SELLHEIM	698
		Cucchiaio per aborto CUZZI	699
		Cucchiaio per aborto PESTALOZZA	700
		Cucchiaio per aborto WALLICH	700

Cucchiaino per calazio HEBRA	713
Cucchiaino per calazio MEYHOEFER	713
Cucchiaino per calazio WELLS	712
Cucchiaino per calcoli biliari DESJARDIN	635
Cucchiaino per calcoli biliari FERGUSSON	636
Cucchiaino per calcoli biliari LUER-KOERTE	635
Cucchiaino per calcoli biliari MAYO	636
Cucchiaino per calcoli biliari MOORE	636
Cucchiaino per orecchio LEMPERS	756
Cucchiaino per utero SCHROEDER	686
Cucchiaino per utero SIMON	686
Cucchiaino SIMON	406
Cucchiaino tagliente BRUNS	404,405
Cucchiaino tagliente HALLE	407
Cucchiaino tagliente SCHEDE	403
Cucchiaino tagliente SCOVILLE	405
Cucchiaino tagliente SPRATT	404
Cucchiaino tagliente VOLKMAN	402,403
Cucchiaino tagliente WILLIGER	407
Cucchiaino tagliente YASARGIL	563
Curette BLAKE	692
Curette COAKLEY	802
Curette con doppio attacco HEMINGWAY	409,410
Curette con doppio attacco MILLER-COLBURN	410
Curette FAULKNER	802
Curette HOUSE	739
Curette per biopsia KEVORKIAN	679
Curette per biopsia NOVAK	679
Curette per biopsia RANDALL	679
Curette per campionamento e aspirazione	693
Curette per ipofisi RAY	561
Curette per lupus FOX	850
Curette per lupus WOLFF	850
Curette per orecchio BUCK	751,752
Curette per orecchio JANSSEN	752
Curette per orecchio LANGENBECK	751
Curette per orecchio SHAPLEIGH	751
Curette per utero BUMM	691
Curette RECAMIER	687,688,689
Curette SIMS	689,690
Custodie per strumenti	873

D

Depressore per utero BRAUN	668
Dermatomo HUMBY	11
Dermatomo SCHINK	11
Dermatomo SILVER	11
Diapason	742
Diapason HARTMANN	742-744
Diapason in alluminio	742
Diapason KÖNIG	745
Diapason LUCAE	744
Diapason NEURO	744
Diapason RYDEL-SEIFFERT	744
DIETRICH-HEGEMANN	43
Dilatatore cardiovascolare TUBBS	539
Dilatatore per dotto biliare BAKES	632
Dilatatore per dotto lacrimale WILDER	716
Dilatatore per trachea LABORDE	843
Dilatatore per trachea TROUSSEAU	843
Dilatatore per utero HANK	666
Dilatatore per utero HEGAR	663-665
Dilatatore per utero PRATT	667
Dilatatore vascolare COOLEY	536,537
Dilatatore vascolare DEBAKEY	537
Dinamometro COLLIN	253
Dinamometro VIGORIMETRO	252
Dischi di fissaggio per fili di Kirschner	372
Disco protettivo	760
Dispositivi di sospensione	859,860
Dispositivo di fissaggio LEYLA	549
Dispositivo di fissaggio LEYLA 1 mandrino, 2 bracci mobili	550

Dispositivo di fissaggio ROCHARD	222
Dispositivo di trazione NABATOFF, flessibile in acciaio inossidabile	227
Dispositivo per circoncisione COMCO	644
Dispositivo per la rimozione di lame per scalpello	8
Dissettore auricolare FISCH	738
Dissettore per dura madre DAVIS	558
Dissettore per dura madre DAVIS	558
Dissettore per dura madre OLIVECRONA	558
Dissettore per dura madre PENFIELD	557
Dissettore per dura madre TOENNIS	558
Dissettore per tonsille HENKE	832
Dissettore per tonsille HURD	831
Dissettore vascolare ROBB	540
Dissettori, elevatori	425,426
Distributore di cotone idrofilo METHOT	875
Distributore di spazzolini MARTIN	858
Distributore per fili di Kirschner, multiplo	377
Divaricatore	154-194
Divaricatore	196-217
Divaricatore	155
Divaricatore addominale	212-222
Divaricatore addominale BALFOUR baby	215
Divaricatore addominale COLLIN	212
Divaricatore addominale DENIS-BROWNE	220
Divaricatore addominale FRANZ	221
Divaricatore addominale GOSSET	215
Divaricatore addominale KIRSCHNER	218,219
Divaricatore addominale O'CONNOR SULLIVAN	218
Divaricatore addominale RICARD	214
Divaricatore addominale ROBIN-MASS	214
Divaricatore addominale SEMM	220
Divaricatore addominale tipo US BALFOUR	216
Divaricatore ADSON	198,203,204
Divaricatore ADSON	205
Divaricatore ADSON	559
Divaricatore ALM	197
Divaricatore anale ALAN-PARKS	625
Divaricatore anale SMITH-BUIE	624
Divaricatore ANDERSON-ADSON	198
Divaricatore BECKMANN	205
Divaricatore BECKMANN-ADSON	206
Divaricatore BECKMANN-EATON	206
Divaricatore BRUNNER	179-181
Divaricatore BUCKLEY	196
Divaricatore CASPAR	572
Divaricatore CLOWARD	210,211
Divaricatore COLLIN	194
Divaricatore COLLIN baby	212
Divaricatore COLLIN-LOKTITE	212
Divaricatore COOLEY	186
Divaricatore CORYLLOS	178
Divaricatore CRILE	194
Divaricatore CUSHING	159-161
Divaricatore CUSHING	559
Divaricatore DAVIDSON	178
Divaricatore DEEVER	185-187
Divaricatore DESMARRÉS	156
Divaricatore di tipo GIL-VERNET	161
Divaricatore DOYEN-STILLE	175
Divaricatore FARABEU	191
Divaricatore FINSEN	196
Divaricatore FRAZIER	559
Divaricatore FRITSCH	176
Divaricatore GELPI	209
Divaricatore GELPI-LOKTITE	209
Divaricatore GOELT	193
Divaricatore GRAHAM	559
Divaricatore HARRINGTON	184
Divaricatore HENLEY	202
Divaricatore HOLZHEIMER	197
Divaricatore HÖSEL	175
Divaricatore ISRAEL	167
Divaricatore JANSEN	197
Divaricatore JOLL (FRIEDMAN)	208

Divaricatore JOLL (FRIEDMANN)	208
Divaricatore KELLY	174,189
Divaricatore KNAPP	156
Divaricatore KOCHER	164,165
Divaricatore KOCHER	172
Divaricatore KOCHER	173
Divaricatore KOCHER	176
Divaricatore KOCHER-LANGENBECK	170
Divaricatore KOERTE	166
Divaricatore LAHEY	169
Divaricatore LANGENBECK	167,168,196
Divaricatore LANGENBECK mini	156
Divaricatore LANGENBECK-GREEN	158
Divaricatore LEYLA, set completo	551
Divaricatore LITTLE	169
Divaricatore LOGAN	196
Divaricatore LUER	194
Divaricatore MARTIN	177
Divaricatore MATHIEU	193
Divaricatore MAYO-ADAMS	208
Divaricatore MERCEDES	484
Divaricatore MEYERDING	157,185
Divaricatore MEYERDING	185
Divaricatore MIDDELDORPF	173,176
Divaricatore MOLLISON	200
Divaricatore MORRIS	184
Divaricatore NORFOLK AND NORWICH	207
Divaricatore O'CONNOR	154
Divaricatore OBWEGESER	819
Divaricatore OLLIER	166
Divaricatore PARKER	192
Divaricatore PARKER-LANGENBECK	193
Divaricatore per aorta CRAWFORD	182
Divaricatore per aorta ROSS	182
Divaricatore per apparecchi gessati HENNIG	349
Divaricatore per bocca DAVIS-BOYLE	811
Divaricatore per bocca DENHARDT	809
Divaricatore per bocca DINGMANN	813
Divaricatore per bocca DOYEN-JANSEN (MOLT)	809
Divaricatore per bocca HEISTER	809
Divaricatore per bocca JENNINGS	814
Divaricatore per bocca KILNER-DOUGHTY	810
Divaricatore per bocca MC IVOR	812
Divaricatore per bocca ROSER-KÖNIG	809
Divaricatore per bocca SIMPLEX	815
Divaricatore per bocca WHITEHEAD	814
Divaricatore per collo della vescica MILLIN	638
Divaricatore per corpi vertebrali CLOWARD	576
Divaricatore per corpi vertebrali INGE	576
Divaricatore per coste BAILEY	485
Divaricatore per coste BAILEY baby	485
Divaricatore per coste BAILEY-GIBBON	485
Divaricatore per coste BURFORD in alluminio	477
Divaricatore per coste CASTANEDA in alluminio	478
Divaricatore per coste COOLEY	475
Divaricatore per coste DEBAKEY	481,482
Divaricatore per coste FINOCHIETTO (mod.)	480
Divaricatore per coste FINOCHIETTO baby	476
Divaricatore per coste FINOCHIETTO baby	476,481
Divaricatore per coste HAIGHT	479
Divaricatore per coste TUFFIER	479
Divaricatore per guance	815
Divaricatore per guance e labbra CAWOOD-MINNESOTA	815
Divaricatore per guance e labbra STERNBERG	815
Divaricatore per laminectomia BADGLEY	568
Divaricatore per laminectomia CASPAR	571
Divaricatore per laminectomia CASPAR completo	569-574
Divaricatore per laminectomia SCOVILLE	566
Divaricatore per palpebra BARRAQUER (COLIBRI)	704
Divaricatore per palpebra CASTROVIEJO	704
Divaricatore per palpebra DESMARRÉS	705
Divaricatore per palpebra MELLINGER	704
Divaricatore per sterno MORSE	483
Divaricatore per sterno MORSE-FAVALORO	483
Divaricatore per torace MERCEDES	484

Forbici per bendaggi SEUTIN 347
 Forbici per chirurgia rettale 42
 Forbici per chirurgia rettale FINOCHIETTO 42
 Forbici per chirurgia rettale RESANO 42
 Forbici per cordone ombelicale BUSCH 29
 Forbici per cordone ombelicale SCHUMACHER 29
 Forbici per coste 472
 Forbici per coste BETHUNE 474
 Forbici per coste e sterno BRUNNER 473
 Forbici per coste GLUCK 472
 Forbici per dissezione FOMON 34
 Forbici per dissezione JAMESON 39
 Forbici per dissezione SUPERCUT JAMESON 74
 Forbici per dura madre SCHMIEDEN-TAYLOR 45
 Forbici per enucleazione 34
 Forbici per episiotomia 29
 Forbici per episiotomia SUPERCUT WALDMANN 69
 Forbici per episiotomia WALDMANN 29
 Forbici per fasciature SUPERCUT LISTER 75
 Forbici per incisione 25
 Forbici per iridectomia BARRAQUER 725
 Forbici per iridectomia CASTROVIEJO 723,724
 Forbici per iridectomia NOYES 724
 Forbici per iridectomia VANNAS 725
 Forbici per iridectomia VANNAS MOD. TÜBINGEN 725
 Forbici per iridectomia WESTCOTT 724
 Forbici per isterectomia con inserti
 in TC PARAMETRIUM 61
 Forbici per la preparazione dei nervi 32
 Forbici per la sezione di fili di sutura BEEBEE 50
 Forbici per legatura BUCK 52
 Forbici per legatura EISELSBERG 52
 Forbici per legatura HEATH 52
 Forbici per legatura LITTAUER 52
 Forbici per legatura NORDBBENT 52
 Forbici per legatura SPENCER 52
 Forbici per lifting facciale SUPERCUT KAYE 74
 Forbici per sterno GIERTZ-STILLE 472
 Forbici per sterno SAUERBRUCH 472
 Forbici per unghie 853
 Forbici per utero BOZEMANN 28
 Forbici SUPERCUT MAYO-SILENCE 66
 Forbici vascolari DE BAKEY 44
 Forbici vascolari DEBAKEY 44
 Forbici vascolari DIETHRICH 43
 Forbici vascolari FAVALORO 45
 Forbici vascolari GOOD 46
 Forbici vascolari KLINGENBERG-LOTH 41
 Forbici vascolari LLOYD-DAVIS 41
 Forbici vascolari MC INDOE 45
 Forbici vascolari POTTS DE MARTEL 44
 Forbici vascolari POTTS-SMITH 44
 Forbici vascolari SATINSKY 41
 Forbici vascolari STELZNER 41
 Forbici vascolari SUPERCUT DIETHRICH 71
 Forbici vascolari SUPERCUT POTTS-SMITH 71
 Forbici vascolari SUPERCUT TOENNIS-ADSON 69
 Forbici vascolari TOENNIS 46
 Forbici vascolari TOENNIS-ADSON 46
 Forchetta filettata YASARGIL 562
 Forchetta per impiantare HARDY 562
 Forcipe ostetrico DE LEE 696
 Forcipe ostetrico KIELLAND 697
 Forcipe ostetrico MCLEAN-LUIKART 697
 Forcipe ostetrico MCLEAN-TUCKER 697
 Forcipe ostetrico NAEGELE 697
 Forcipe ostetrico PIPER 697
 Forcipe ostetrico SIMPSON 696
 Forcipe ostetrico SIMPSON-BRAUN 696
 Forcipe ostetrico WRIGLEY 696
 Fresa a sfera STILLE 357
 Fresa HUDSON 358

G
 Ganascia di ricambio in FERROCELL 401
 Ganci FOMON 799
 Goniometro a dito CAROLL 253
 Goniometro MOELTGEN 253
 Guida filettata YASARGIL 563

H
 HARKEN 488
 HOHMANN-ALDINGER 431

I
 Impugnatura KEYES 851
 Impugnatura per aspiratore COUPLAND 239
 Impugnatura per pinza per biopsia 684
 Impugnatura per specchio per laringe 842
 Impugnatura per speculum vaginale SCHERBAK 660
 Impugnatura per trapano VICKERS-EASYDRIVER 373
 Impugnatura singola NABATOFF 227
 Impugnatura universale HUBER 838
 ING. Morsetto per teli MODELL 143
 ING. Pinzetta anatomica MODELLO 80
 Inserti in gomma per pinza tiralingua YOUNG 818

K
 KIRSCHNER Gancio per telaio 219

L
 Laccio emostatico ESMARCH 355
 Lama centrale JUDD-MASSON 639
 Lama centrale MILLIN 639
 Lama centrale RICARD 213
 Lama di ricambio per bisturi ad anello LA FORCE 804
 Lama di ricambio per dermatomo HUMBY 11
 Lama di ricambio per sega 469
 Lama di ricambio per sega BIER 352
 Lama di ricambio per sega CHARRIERE 353
 Lama di ricambio per sega per anelli MARTIN 469
 Lama di ricambio per sega per anelli WALTON 469
 Lama di ricambio per sega RUST 352
 Lama di ricambio per uretrotomia OTIS 643
 Lama oscillante BALLENGER 780
 Lama per osteotomia intercambiabile 387
 Lama per scalpello 7,8
 Lama per scalpello piatto 387
 Lama per sega oscillante per apparecchi gessati 350
 Lama per sega SATTERLEE 353
 Lama per sgorbia intercambiabile 387
 Lama singola di ricambio 11
 Lamette, frangibili 14
 Lampada di ricambio per laringoscopia 272
 Lampada di ricambio per laringoscopia a luce fredda 279
 Lampada di ricambio per oftalmoscopia 259
 Lampada frontale CLAR 261,262
 Lampade di ricambio per otoscopia 259
 Laringoscopi per procedure operative portallampada
 in fibra di vetro 280-284
 Laringoscopia per procedure operative 281
 Laringoscopia per procedure operative JACKSON 281
 Legante RÖDER/seranodi per tonsille 835
 Legatore per emorroidi MC GIVNEY 627
 Legatore per emorroidi RUDD 627
 Lente BERGER 263
 Lente d'ingrandimento frontale BERGER completa 263
 Lima nasale AUFRICHT (WIENER) 793
 Lima nasale con inserti in TC FOMON 795

Lima nasale COTTLE 793
 Lima nasale FOMON 794
 Lima nasale FOMON 795
 Lima nasale GALLAHER 793
 Lima nasale JOSEPH 792
 Lima nasale LEWIS 794
 Lima nasale MALTZ 792
 Lima per ossa 423,424
 Lima per ossa con inserti in TC MILLER-COLLBURN 423
 Lima per ossa MILLER-COLLBURN 421,422
 Lima per ossa PUTTI 424
 Lima per unghie 855

M
 Mandrino completo con manico a T 358
 Mandrino di ricambio 545
 Manici per scalpello 5,6
 Manico a batteria 272,279
 Manico a batteria per ferri per strumenti diagnostici 259
 Manico a luce fredda 280
 Manico ELLIOT 714
 Manico per ring stripper 228
 Manico per sega GIGLI 544
 Manico SLUDDER-BALLENGER 836
 MANICO UNIVERSALE per set per tunneling 538
 Manico in Ferrocil per lama per scalpello
 intercambiabile 387
 Manicoper oftalmoscopia 259
 Mano di piombo per adulti 467
 Mano di piombo per bambini 467
 Manometro 694
 Manometro con sfera in gomma 265
 Manometro per tourniquet emostatico 354
 Martello 393-401
 Martello BABINSKI 249
 Martello BERGMANN 398
 Martello BERGMANN 399
 Martello BERLINER 248
 Martello BUCK 249
 Martello COLLIN 396
 Martello con manico in plastica 400
 Martello COTTLE 397
 Martello DEJERINE 248
 Martello DOYEN 395
 Martello GERZOG 398
 Martello HAJEK 398
 Martello HEATH 399
 Martello in Ferrocil 400
 Martello in metallo 401
 Martello KIRK 398
 Martello KIRK 400
 Martello LUCAE 396
 Martello MEAD 397
 Martello OMBREDANNE 399
 Martello PARTSCH 397
 Martello RABINER 249
 Martello TAYLOR 248
 Martello TROEMMER 248
 Martello WILLIGHTY 395
 Martello WILLIGHTY 397
 Martello, senza ripercussione con manico in plastica 400
 Meniscomotomo SMILLIE 436
 Mentoniera OBWEGESER 821
 MICHEL MOD. Pinza 338
 Micro cannula per aspirazione BELLUCCI 235
 Micro cannula per aspirazione WULLSTEIN 235
 Micro forbici 16-19
 Micro forbici GOMEL 17
 Micro forbici HEPP-CUTTERS 17,19
 Micro forbici JACOBSON 16
 Micro forbici POTTS 16
 Micro forbici WESTCOTT 17
 Micro pinzetta 92

Micro pinzetta anatomica Adson	78	Morsetti per arterie, pinze per medicazioni e tamponi	101-152	Morsetto emostatico per vasi periferici	
Micro pinzetta chirurgica ADSON	82	Morsetti per dissez./legat. RUMEL	128	atraumatico DALE	519
Micro pinzetta con inserti in TC ADSON	97,98	Morsetti per urologia a presa tangenziale		Morsetto emostatico per vasi periferici	
Micro pinzetta per legatura	95-96	atraumatiche	136	atraumatico HUSFELDT	521
Micro porta-ago con inserti in TC AUSTIN	96	Morsetti WIRKSTROEM	132	Morsetto emostatico per vasi periferici	
Micro pinzetta per legatura LAZAR	96	Morsetto GUYON	134	atraumatico MARTIN	520
Micro pinzetta per legatura VISE	96	Morsetto testa WILLET-MARTEL	121	Morsetto emostatico per vasi periferici	
Micro pinzette YASARGIL	94	Morsetto ADSON	124	traumatico SUBRAMANIAN	524
Micro porta-ago con inserti in TC ARRUGA	312	Morsetto ADSON baby	124	Morsetto emostatico SATINSKY	488
Micro porta-ago con inserti in TC BOYNTON	312	Morsetto ADSON micro	124	Morsetto emostatico SATINSKY baby	487
Micro porta-ago con inserti in TC KALT	312	Morsetto Allis per prostata MILLIN	638	Morsetto FERGUSON	121
Micro porta-ago con inserti in TC SLIM	320	Morsetto ADSON	604	Morsetto FINOCHIETTO	134
Micro tubo per aspirazione completo BELLUCCI	235	Morsetto atraumatico ALLIS	604	Morsetto MIXTER-O'SHAUGNESSY	132
Microago auricolare BARBARA	735	Morsetto atraumatico BABCOCK	606	Morsetto per stomaco LANE	611
Microbisturi circolare ROSEN	734	Morsetto atraumatico BAINBRIDGE	496	Morsetto HALSTEAD-MOSQUITO	106,107
Microbisturi YASARGIL	563	Morsetto atraumatico BRUNNER	619	Morsetto HEANEY	140
Microcucchio per ipofisectomia	564	Morsetto atraumatico WEBER	619	Morsetto HEISS	123
Microcurette per ipofisi HARDY	561	Morsetto atraumatico RANKIN-DEBAKEY	493	Morsetto JOHNS-HOPKINS	125
Microdissettore per attico AUSTIN	737	Morsetto atraumatico LELAND-JONES	500	Morsetto LAHEY	134
Microdissettore per ipofisectomia	564	Morsetto atraumatico MOSQUITO-DEBAKEY	493	Morsetto LERICHE	109
Microforbici auricolari BELLUCCI	731	Morsetto atraumatico PEAN-DEBAKEY	494,495	Morsetto LOWER	134
Microforbici auricolari WULLSTEIN	731	Morsetto atraumatico RANKIN-DEBAKEY	493	Morsetto MARTEL	121
Microforbici nasali	774	Morsetto atraumatico SATINSKY	506	Morsetto MC QUIGG-MIXTER	134
Microforbici NICOLA	601	Morsetto atraumatico SCUDDER	618	Morsetto MIXTER	132-134
Microforbici oftalmiche	723	Morsetto atraumatico VEIDENHEIMER	620	Morsetto MIXTER baby	123
Microforbici oftalmiche AEBLI	723	Morsetto atraumatico WEBER	505	Morsetto MIXTER-O'SHAUGNESSY	132
MicroMicro forbici REIL	19	Morsetto BAINBRIDGE	122	Morsetto OVERHOLT-BEISENDOERFER	127
Microperiototomo	564	Morsetto BENGOLEA	119	Morsetto OVERHOLT-MIXTER	125
Microperiototomo auricolare ROSEN	738	Morsetto BIRKETT	125	Morsetto per anastomosi atraumatica COOLEY	525
Micropinza da presa	600,601	Morsetto BUIE	121	Morsetto per anastomosi atraumatica COOLEY-BECK	530
Micropinza da presa NICOLA	601	Morsetto bulldog	101-152	Morsetto per anastomosi DE MARTEL-WOLFSON	614
Micropinza da presa per ipofisectomia	565	Morsetto bulldog atraumatico CLOVER	491,492	Morsetto per aneurisma BAHNSON-DEBAKEY	511
Micropinza da presa per laringe	841	Morsetto bulldog atraumatico DEBAKEY	490	Morsetto per aorta atraumatico DIETHRICH	517
Micropinza da presa YASARGIL	601	Morsetto bulldog atraumatico DEBAKEY-SATINSKY	490	Morsetto per aorta atraumatico HARKEN	507
Micropinza per orecchio	728-730	Morsetto bulldog atraumatico GLOVER	491,498	Morsetto per aorta atraumatico LAMBERT-KAY	509
Micropinza per orecchio a cucchiaio HARTMANN	749	Morsetto bulldog atraumatico SANTULLI	492	Morsetto per aorta atraumatico LEES	508
Micropinza per orecchio a cucchiaio		Morsetto bulldog DEBAKEY-DIETHRICH	105	Morsetto per aorta atraumatico OCHSNER	517
HARTMANN-HOFFMANN	749	Morsetto bulldog DIEFFENBACH	106	Morsetto per aorta MORRIS-DEBAKEY	510
Micropinza per orecchio FULLER	731	Morsetto bulldog DIETHRICH	105	Morsetto per arteria iliaca atraumatica COOLEY	525
Micropinza per orecchio HARTMANN	748,749	Morsetto bulldog HESS	106	Morsetto per arterie CARREL	108
Micropinza per orecchio HARTMANN-WULLSTEIN	749	Morsetto bulldog JOHNS-HOPKINS	106	Morsetto per arterie CRILE	110
Micropinza per orecchio LITTAUER	748	Morsetto bulldog TITAN - Per arterie	103	Morsetto per arterie CRILE-RANKIN	111
Micropinza per orecchio MC GEE	732	Morsetto bulldog TITAN - Per vene	102	Morsetto per arterie DIXON-LOVELACE	111
Micropinza per orecchio STRÜMPPEL	749	Morsetto CRAFOORD	126	Morsetto per arterie HARTMANN	108
Micropinza per orecchio TILLEY	748	Morsetto CRAFOORD-SELLORS	126	Morsetto per arterie KELLY	110
Micropinza per orecchio WULLSTEIN	728	Morsetto da presa per intestini ALLIS	604	Morsetto per arterie KELLY-RANKIN	110
Micropinza per orecchio WULLSTEIN	732	Morsetto da presa per intestino ALLIS baby	604	Morsetto per arterie KROENLEIN	109
Micropinza per orecchio, a forma di cucchiaio	730	Morsetto da presa per intestino ALLIS-ADAIR	604	Morsetto per arterie MOSQUITO-BANDY	109
Micropinza per tonsille	834	Morsetto da presa per intestino BABCOCK	606	Morsetto per arterie OVERHOLT baby	111
Microsonda di misurazione HOUSE	738	Morsetto da presa per intestino BABCOCK baby	606	Morsetto per arterie ROCHESTER-PEAN	114,115
Microstrumenti YASARGIL	562,563	Morsetto da presa per intestino DUVAL	607	Morsetto per arterie SPENCER-WELLS	112
Microstrumento KOOS	563	Morsetto da presa per intestino GIUDD-ALLIS	605	Morsetto per arterie Terrier	108
Microstrumento KRAUS	563	Morsetto da presa per intestino LOCKWOOD-ALLIS	605	Morsetto per arterie TOENNIS	130
Microuncino auricolare	736,737	Morsetto da presa per intestino THOMS-ALLIS	605	Morsetto per bronchi PRICE-THOMAS	486
Microuncino auricolare MC GEE	736	Morsetto da presa per intestino WILLIAMS	605	Morsetto per bronchi SEMB	486
Microuncino per ipofisectomia	564	Morsetto da presa per tumori CHAPUT	120	Morsetto per carotide atraumatica COOLEY	525
Microuncino per sondaggio SHEA	737	Morsetto da presa per vasi con inserti in TC DUVAL	607	Morsetto per carotide atraumatica GREGORY	492
MIKULICZ	188	Morsetto da presa per vasi con inserti in TC BABCOCK	606	Morsetto per carotide morbida atraumatica GREGORY	492
MILLIGAN	201	Morsetto DANDY	109	Morsetto per catetere atraumatica COOLEY	529
Mini morsetto per dissezione e legatura GEMINI	128	Morsetto emostatica atraumatica multiuso C		Morsetto per cordone ombelicale COLLIN	700
Mini porta-ago con inserti in TC OLSEN-HEGAR	324	OOLEY	526,527,528	Morsetto per cordone ombelicale KANE	700
MINIATURA ATRAUMATICA SUBRAMANIAN	524	Morsetto emostatica atraumatico		Morsetto per dissezione e legatura	127-134
MOD. Forbici per cordone ombelicale USA	29	DEBAKEY	498, 499, 501-503	Morsetto per dissezione e legatura GEMINI	129
Mod. Strumento per nodi da sutura WIEN	336	Morsetto emostatica atraumatico POTTS	496-498,512	Morsetto per dissezione e legatura LAWRENCE	132
Morsetti da presa per tumori TUFFIER	120	Morsetto emostatica atraumatico POTTS-GLOVER	498	Morsetto per dissezione e legatura MEEKER	131
Morsetti PENNINGTON	120	Morsetto emostatico atraumatico BECK	516	Morsetto per dissezione GRAY	133
Morsetti per anastomosi atraumatica COOLEY-DERRA	530	Morsetto emostatico atraumatico DARDIK	522	Morsetto per dotto biliare e peduncolo renale	134,135
Morsetti per aorta atraumatici DEBAKEY	504	Morsetto emostatico atraumatico DERRA	516	Morsetto per intestino atraumatico DOYEN	616
MORSETTI per arterie	107-119	Morsetto emostatico atraumatico GLOVER	515	Morsetto per intestino atraumatico DOYEN baby	616
Morsetti per arterie KOCHER	116	Morsetto emostatico multiuso DEBAKEY	513,514	Morsetto per intestino atraumatico KOCHER	617
Morsetti per arterie KOCHER-DELICATE	116	Morsetto emostatico per bambini atraumatico		Morsetto per intestino atraumatico MAYO-ROBSON	617
Morsetti per arterie KOCHER-OCHSNER	117,118	COOLEY	532-534	Morsetto per intestino DOYEN	608
Morsetti per arterie PEAN	113	Morsetto emostatico per bambini DEBAKEY	531	Morsetto per intestino DOYEN baby	608
Morsetti per arterie PEAN-DELICATE	113	Morsetto emostatico per neonati atraumatico		Morsetto per intestino e stomaco SCUDDER	610
		CASTANEDA	535	Morsetto per intestino KOCHER	609
				Morsetto per intestino MAYO-ROBSON	609

Inhaltsverzeichnis
Alphabetical Index
Indice alfabético
Indice alfabético



Morsetto per isterectomia 138-142
 Morsetto per isterectomia FANEUF 138
 Morsetto per isterectomia HEANEY-BALLENTINE 140
 Morsetto per isterectomia HEANEY-KANTER 141
 Morsetto per isterectomia HEANEY-REZEK 140
 Morsetto per isterectomia MAINGOT 141
 Morsetto per isterectomia MIKULICZ 139
 Morsetto per isterectomia MOYNIHAN 138
 Morsetto per isterectomia ROGERS ATRAUMA 142
 Morsetto per isterectomia SEGOND-LANDAU 139
 Morsetto per isterectomia WERTHEIM 138,139
 Morsetto per isterectomia WERTHEIM-CULLEN 139
 Morsetto per legatura DESJARDIN 133
 Morsetto per legatura KANTROWITZ 132
 Morsetto per legatura KELLY 130
 Morsetto per legatura MIXTER-CRAFOORD 126
 Morsetto per legatura OVERHOLT 127
 Morsetto per menisco BIRCHER-GANSKE 442
 Morsetto per muscolo MASTIN 849
 Morsetto per peduncolo renale GUYON ATRAUMA 134
 Morsetto per peduncolo renale HERRICK 136
 Morsetto per profunda atraumatico GREGORY 518
 Morsetto per prostata MILLIN a T 638
 Morsetto per prostatectomia atraumatico MILLIN 638
 Morsetto per rene STILLE 136
 Morsetto per retto atraumatico FEHLAND 620
 Morsetto per retto atraumatico RESANO 621
 Morsetto per shunt carotideo atraumatico JAVID 523
 Morsetto per stomaco NUSSBAUM 612
 Morsetto per teli 143-145
 Morsetto per teli BACKHAUS 143
 Morsetto per teli BERNHARD 144
 Morsetto per teli di carta BALL+SOCKET 144
 Morsetto per teli GROSS 146
 Morsetto per teli HOFF 145
 Morsetto per teli JONES 143
 Morsetto per teli LANE 144
 Morsetto per teli LORNA 144
 Morsetto per teli PEAN 146
 Morsetto per teli PEERS 145
 Morsetto per teli ROBIN con supporto 145
 Morsetto per teli ROEDER 144
 Morsetto per teli SCHAEDEL 143
 Morsetto per teli TOHOKU 145
 Morsetto per tonsille NEGUS 133
 Morsetto perforata per tendine 441
 Morsetto peritoneale FAURE 137
 Morsetto peritoneale MIKULICZ 137
 Morsetto peritoneale MIKULICZ baby 137
 Morsetto peritoneale, morsetto per isterectomia 138,138
 Morsetto PRATT 121
 Morsetto PROVIDENCE-HOSPITAL 109
 Morsetto ROBERTS 125
 Morsetto ROCHESTER-CARMALT 122
 Morsetto SAROT 126
 Morsetto SCHNIDT 124
 Morsetto stringitubo 146,147
 Morsetto stringitubo HOFFMANN 863
 Morsetto stringitubo PRESBYTERIAN 146
 Morsetto ZENKER 131
 Morso in silicone DENHARDT 809
 Mucotomo FREER 779
 Mucotomo TABB 734

O

Oliva a vite 538
 Oliva auricolare BARANY 745
 Oliva in metallo 760
 Oliva NABATOFF 227
 Osteotomi LEXER 389
 Osteotomo 380,381-385,387-393
 Osteotomo CINELLI 788
 Osteotomo COTTURA 786

Osteotomo COTTURA 786,787
 Osteotomo DAHMEN 393,394
 Osteotomo FOMON 788
 Osteotomo HIBBS 384,385
 Osteotomo LAMBOTTE 382
 Osteotomo NEIVERT-ANDERSON 788
 Osteotomo OBWEGESER 823,824
 Osteotomo PARKES 790
 Osteotomo per osso spongioso LEXER 388
 Osteotomo RUBIN 787
 Osteotomo SHEEHAN 789
 Osteotomo SILVER 790
 Osteotomo SMITH-PETERSON 383
 Osteotomo STILLE 381
 Osteotomo WALTER 787
 Osteotomo WALTER 787
 Otturatore sintetico IVES-FANSLER 625

P

Padella 876
 Paradita LANGENBECK 808
 Pattumiera 886
 Pelvimetro COLLIN 695
 Pelvimetro COLLYER 695
 Pelvimetro MARTIN 695
 Perforatore a mano BUNELL 359
 Perforatore a mano RALK 359
 Perforatore a mano STILLE 357
 Perforatore HUDSON 358
 Perforatore spirale ADSON 358
 Perforatore spirale MC KENZIE 358
 Perforatore spirale STILLE 357
 Perforatore spirale MASING 411-420
 Perforatore spirale DOYEN 420
 Perforatore spirale FARABEUF 805
 Perforatore spirale COBB 414
 Perforatore spirale COTTLE 782
 Perforatore spirale DOYEN 417,418
 Perforatore spirale FARABEUF 416
 Perforatore spirale JOSEPH 783
 Perforatore spirale LAMBOTTE 418
 Perforatore spirale LANGENBECK 415
 Perforatore spirale MASING 783
 Perforatore spirale OBWEGESER 822,823
 Perforatore spirale per coste ALEXANDER 420
 Perforatore spirale per coste MATSON 420
 Perforatore spirale SEDILOT 416
 Perforatore spirale SEMB 419
 Perforatore spirale WAGNER 412,413
 Perforatore spirale WILLIGER 416,417
 Peso per speculum vaginale SCHERBAK 660
 Pezzo intermedio LUER-LOCK 244
 Piastra di supporto per accessori per tunneling 538
 Piastra per palpebra JAEGER 705
 Piastra singola di serraggio 11
 Piastrine di arresto fessurata 372
 Piccolo trasformatore per lampada frontale 262
 Pinza a grafes COLLIN 338
 Pinza a gancio SCHROEDER 670
 Pinza a molla MOHR 763
 Pinza a tamburo per filo 363-365
 Pinza auricolare Alligator MCGEE mini 729
 Pinza auricolare HOUSE-DIETER 732,731
 Pinza con coperchio con cilindro verticale 861
 Pinza crimpatrice per apparato gastrointestinale
 PAYR 613
 Pinza crimpatrice per apparato gastrointestinale PAYR
 baby 613
 Pinza cutter con inserti in TC 366-368
 Pinza cutter per filo 366
 Pinza da presa IUP 685
 Pinza da presa MC GIVNEY 628
 Pinza da presa per biopsia del retto YEOMAN 627

Pinza da presa per intestino e tessuti ALLEN 607
 Pinza da presa per intestino e tessuti LITTLEWOOD 606
 Pinza da presa per organi atraumatica 615
 Pinza da presa per organi atraumatica SCHEIBE 615
 Pinza da presa per polipo HEYWOOD-SMITH 628
 Pinza da presa per polipo LUER 628
 Pinza da presa per polmone LOVELACE 487
 Pinza da presa per polmone LOVELACE 487
 Pinza da presa per tendine BRAND 440
 Pinza da presa per tendine KLEINERT-KUTZ 441
 Pinza da presa per tendine STEINMANN 440
 Pinza da presa per tumori LANDOLT 597
 Pinza da presa per utero COLLIN 675
 Pinza da presa per utero DARTIGUES 675
 Pinza da presa per utero KELLY 674
 Pinza da presa per utero SOMER 675
 Pinza da presa SERPENTINE IUP 685
 Pinza emostatica BOZEMANN-DOUGLAS 150
 Pinza emostatica FOERSTER 150,151
 Pinza emostatica HARKEN 488
 Pinza emostatica RAMPLEY 149,151
 Pinza emostatica RAMPLEY 151
 Pinza etmoidale TAKAHASHI 769
 Pinza guidafile MILLIN a U 638
 Pinza MICHEL 338
 Pinza nasale tagliente BRUENINGS 768
 Pinza nasale tagliente HARTMANN 769
 Pinza nasale tagliente HEYMANN 767
 Pinza nasale tagliente KNIGHT 767
 Pinza nasale tagliente LUC 768
 Pinza nasale tagliente SCHMEDEN 769
 Pinza nasale tagliente WATSON-WILLIAMS 769
 Pinza nasale WEIL-BLAKESLEY 770-772
 Pinza per aborto SAENGER 698
 Pinza per aborto WINTER 699
 Pinza per biopsia BURKE 683
 Pinza per biopsia KEVORKIAN-PACIFICO 683
 Pinza per biopsia MINI-TOWNSEND 683
 Pinza per biopsia TISCHLER baby 683
 Pinza per biopsia TISCHLER-KEVORKIAN 683
 Pinza per biopsia TISCHLER-MORGAN 683
 Pinza per biopsia TOWNSEND 684
 Pinza per biopsia TOWNSEND mini (TISCHLER baby) 684
 Pinza per biopsia TOWNSEND mini (TISCHLER baby) 684
 Pinza per biopsia uterina ALEXANDER 682
 Pinza per biopsia uterina EPPENDORFER 682
 Pinza per biopsia uterina KEVORKIAN 682
 Pinza per biopsia uterina SCHUMACHER 682
 Pinza per biopsia uterina WITTMER 682
 Pinza per broncoscopio CHEVALIER-JACKSON 838
 Pinza per calcoli biliari BLAKE 634
 Pinza per calcoli biliari CZERNY 634
 Pinza per calcoli biliari DESJARDIN 635
 Pinza per calcoli biliari MAYO-BLAKE 634
 Pinza per calcoli biliari MIXTER 635
 Pinza per calcoli biliari STILLE 635
 Pinza per calcoli biliari TURNER-WARWICK 634
 Pinza per catetere MAGILL 266
 Pinza per corpi estranei MATHIEU 645
 Pinza per cranio 546
 Pinza per filo con inserti in TC 365
 Pinza per fistola renale ELSÄSSER 631
 Pinza per gozzo BRAUN 849
 Pinza per gozzo LAHEY 849
 Pinza per ipofisi YASARGIL 597
 Pinza per la rimozione di lame per scalpello 8
 Pinza per laminectomia CASPAR 595,596
 Pinza per laminectomia CUSHING 592
 Pinza per laminectomia FERRIS-SMITH 599
 Pinza per laminectomia LOVE-GRUENWALD 593
 Pinza per laminectomia OLDBERG 597
 Pinza per laminectomia SPURLING 594
 Pinza per medicazioni e tamponi 148-151
 Pinza per medicazioni e tamponi (seno) LISTER 149
 Pinza per medicazioni e tamponi BRYANT 149

Pinza per medicazioni e tamponi SIMS-MAIER	149	Pinza sgorbia MEAD	454	Pinzetta chirurgica con inserti in TC ADSON-BROWN	98
Pinza per medicazioni GROSS-MAIER	148	Pinza sgorbia RUSKIN	457	Pinzetta chirurgica con inserti in TC BONNY	99
Pinza per peduncolo renale HEIMING	630	Pinza sgorbia SAUERBRUCH	460	Pinzetta chirurgica con inserti in TC GILLIES	99
Pinza per peduncolo renale RANDALL	629,630	Pinza sgorbia SEMB	457	Pinzetta chirurgica con inserti in TC OEHLER	99
Pinza per pene STOCKMANN	645	Pinza sgorbia STELLBRINK	453	Pinzetta chirurgica con inserti in TC SEMKEN	99
Pinza per pene STRAUSS	645	Pinza sgorbia STILLE	457	Pinzetta chirurgica CUSHING	84
Pinza per polipi laringei JURASZ	840	Pinza sgorbia STILLE-LUER	459,460	Pinzetta chirurgica DUEHRSEN	85
Pinza per polipi nasali CRAIG	767	Pinza sgorbia STILLE-RUSKIN	458	Pinzetta chirurgica DURANTE	86
Pinza per polipi uterini NOTO	674	Pinza sgorbia ZAUFAL-JANSEN	456	Pinzetta chirurgica DUVAL	87
Pinza per prelievo di campioni tissutali FAURE	680	Pinza tagliafilo DIAMOND	366	Pinzetta chirurgica FERRIS-SMITH	85
Pinza per prelievo di campioni tissutali GELLHORN	680	Pinza tendifilo con inserti in TC	362	Pinzetta chirurgica GERALD	84
Pinza per prelievo di campioni tissutali SCHUBERT	680	Pinza tendifilo con inserti in TC BARRY-STERNDAL	362	Pinzetta chirurgica GILLIES	83
Pinza per prelievo di campioni tissutali THOMS GAYLOR	681	Pinza tendifilo con inserti in TC CORWIN-HEGAR	362	Pinzetta chirurgica LANE	85
Pinza per prelievo di campioni tissutali VAN DOREN	681	Pinza tiralingua COLLIN	818	Pinzetta chirurgica LERCHE	83
Pinza per rifiuti	886	Pinza tiralingua YOUNG	818	Pinzetta chirurgica MODELLO USA	82
Pinza per rifiuti SAUERBRUCH	886	Pinza tranciante per anelli	469	Pinzetta chirurgica POTTS-SMITH	84
Pinza per riposizione	443	Pinzatendifilo DEMEL	369	Pinzatendifilo RAMSEY	86
Pinza per riposizione ROWE	828	Pinze a uncino BARRET	669	Pinzetta chirurgica RUSS.MODELL	86
Pinza per schegge	100	Pinze a uncino BRAUN	670	Pinzetta chirurgica SEMKEN	83
Pinza per schegge PEET	100	Pinze a uncino BRAUN	674	Pinzetta chirurgica standard	81
Pinza per schegge RALK (VIRTUS)	100	Pinze a uncino SKEENE	674	Pinzetta chirurgica STILLE	82
Pinza per schegge STIEGLITZ	100	Pinze a uncino DUPLAY	671	Pinzetta chirurgica STILLE-BARRAYA	85
Pinza per sequestri	444	Pinze a uncino JACOBS	672	Pinzetta chirurgica STONE	83
Pinza per sequestri VAN BUREN	444	Pinze a uncino JARCHO	669	Pinzetta chirurgica TAYLOR	83
Pinza per setto	767	Pinze a uncino MUSEUX	672	Pinzetta chirurgica TREVES	86
Pinza per setto ASCH	801	Pinze a uncino POZZI	670	Pinzetta chirurgica WAUGH	85
Pinza per setto COTTLE-WALSHAM	801	Pinze a uncino PRATT	673	Pinzetta ciglia BARRAQUER	91
Pinza per setto KRESSNER	801	Pinze a uncino SCHRÖDER	671	Pinzetta ciglia BEER	91
Pinza per setto MIDDELTON-JANSEN	775	Pinze a uncino SKEENE	671	Pinzetta ciglia DOUGLAS	90
Pinza per setto RUBIN	775	Pinze a uncino STAUDE-MOORE	669	Pinzetta ciglia DOUGLAS	91
Pinza per snodo sferico LEYLA	551,552	Pinze a uncino TEALE	671	Pinzetta ciglia LITTAUER	90
Pinza per sterilizzazione	862	Pinze cutter con inserti in TC	367,368	Pinzetta ciglia SHAAF	90
Pinza per sterilizzazione BUNT	863	Pinze da presa COLLIN	120	Pinzetta con inserti in TC	97-99
Pinza per sterilizzazione CHEATTLE	862	Pinze da presa per tessuti	120	Pinzetta con inserti in TC DEBAKEY	99
Pinza per sterilizzazione MAYO	863	Pinze da presa per vasi BOYS-ALLIS	605	Pinzetta con inserti in TC WANGENSTEEN	98
Pinza per sterilizzazione ROGGE	862	Pinze nasali taglienti STRUYCKEN	770	Pinzetta da presa COLLIN-DUVAL	87
Pinza per sterilizzazione universale	862	Pinze per tonsille HARTMANN	837	Pinzetta da presa DENIS-BROWNE	87
Pinza per sutura CHILDE	337	Pinze per trazione craniale	545	Pinzetta da presa LESTER	720
Pinza per taglio cesareo GREEN-ARMYTAGE	698	Pinze per trazione craniale CRUTCHFIELD	545	Pinzetta da presa NELSON	87
Pinza per tamponi BOZEMANN	150	Pinze rompigesto WOLFF	349	Pinzetta da presa per cute COTTLE	801
Pinza per tamponi CHERON	149	Pinze sgorbie	453 - 460	Pinzetta da presa SINGLEY-TUTTLE	87
Pinza per tamponi COLLIN	149	Pinzetta chirurgica con inserti in TC FERRIS-SMITH	99	Pinzetta Iris BISHOP-HARMAN	719
Pinza per tamponi nasali HARTMANN	766	Pinzetta anatomica ADSON	78	Pinzetta Iris GRAEFFE	718
Pinza per tamponi nasali KILLIAN	767	Pinzetta anatomica	78-80	Pinzetta Iris STEVENS	718
Pinza per tamponi nasali LUBET-BARBON	766	Pinzetta anatomica BROPHY	79	Pinzetta LUCAE	747
Pinza per tamponi nasali WESTMACOTT	766	Pinzetta anatomica con inserti in TC ADSON	97	Pinzetta per calazio AYER	722
Pinza per tamponi ULRICH	148	Pinzetta anatomica con inserti in TC CUSHING	97	Pinzetta per calazio DESMARRS	722
Pinza per tonsille bianca	834	Pinzetta anatomica con inserti in TC CUSHING-TAYLOR	97	Pinzetta per calazio LAMBERT	722
Pinza per tonsille bianca (COLVER)	834	Pinzetta anatomica con inserti in TC MC INDOE	98	Pinzetta per calazio SNELLEN	721
Pinza per tonsille BLOHMKE	834	Pinzetta anatomica con inserti in TC POTTS-SMITH	98	Pinzetta per columella COTTLE	801
Pinza per tonsille MIKULICZ	834	Pinzetta anatomica con inserti in TC SEMKEN	98	Pinzetta per fissaggio BARRAQUER (COLIBRI)	719
Pinza per tonsille SCHNIDT	834	Pinzetta anatomica con inserti in TC standard	97	Pinzetta per fissaggio BARRAQUER CATSON (COLIBRI)	719
Pinza per utero DOYEN	674	Pinzetta anatomica CUSHING	80	Pinzetta per fissaggio BARRAQUER-CATSIN	719
Pinza piatta	363,364	Pinzetta anatomica DUEHRSEN	80	Pinzetta per fissaggio TROUTMAN (COLIBRI)	719
Pinza piatta HACKSTOCK	363	Pinzetta anatomica GERALD	80	Pinzetta per orecchio TROELTSCH (WILDE)	747
Pinza piatta per filo	363-365	Pinzetta anatomica GRAEFFE	88	Pinzetta per schegge FEILCHENFELD	90
Pinza RICHTER-HEATH	338	Pinzetta anatomica MC INDOE	79	Pinzetta per schegge HUNTER	89
Pinza sgorbia BEYER	456	Pinzetta anatomica MODELLO USA	78	Pinzetta per schegge WALTER-CARMALT	89
Pinza sgorbia BLUMENTHAL	455	Pinzetta anatomica POTTS-SMITH	79	Pinzetta per schegge, micro pinza senza perno	89
Pinza sgorbia BÖHLER	456	Pinzetta anatomica RAMSEY	80	Pinzetta per schegge, micro pinzetta	89-91
Pinza sgorbia BUMENTHAL	455	Pinzetta anatomica SEMKEN	79	Pinzetta per schegge, micro pinzetta con perno	89
Pinza sgorbia CLEVELAND	454	Pinzetta anatomica standard	78	Pinzetta per sutura BONACCOLTO	721
Pinza sgorbia ECHLIN	458	Pinzetta anatomica TAYLOR	79	Pinzetta per sutura CASTROVIEJO	720
Pinza sgorbia FRIEDMANN	453	Pinzetta atraumatica DEBAKEY	489	Pinzetta per sutura HEGENBARTH	338
Pinza sgorbia FRIEDMANN mini	453	Pinzetta atraumatica DEBAKEY	489	Pinzetta per sutura MICHEL	337
Pinza sgorbia FRIEDMANN-VICKERS	453	Pinzetta CASPAR	570	Pinzetta per sutura NUGENT	721
Pinza sgorbia FRYKHOLM	459	Pinzetta chirurgica	78-99	Pinzetta per sutura WACHENFELDT	338
Pinza sgorbia HARTMANN	454	Pinzetta chirurgica	81-87	Pinzetta per tamponi nasali JANSEN (GRUENWALD)	766
Pinza sgorbia JANSEN	454,456	Pinzetta chirurgica ADLERKREUTZ	83	Pinzetta per tamponi nasali TRÖLTSCH	766
Pinza sgorbia JANSEN	456	Pinzetta chirurgica ADSON	82	Pinzetta per tumori HEIFETZ	93
Pinza sgorbia LEKSELL-SILENZE	458	Pinzetta chirurgica ADSON-BROWN	82	Pinzetta per tumori HUNT	94
Pinza sgorbia LEMPERT	455	Pinzetta chirurgica BONNEY	86	Pinzetta per tumori SAMII	94
Pinza sgorbia LUER	455	Pinzetta chirurgica BROPHY	84	Pinzetta per tumori YASARGIL	93
Pinza sgorbia MARQUARDT	457	Pinzetta chirurgica BROWN	86	Pinzetta per tumori YASARGIL-SAMMII	93
Pinza sgorbia MAYFIELD	456	Pinzetta chirurgica con inserti in TC ADSON	98	Pinzettaa ciglia	91

Pistola per pulizia AQUAJET completa 878
Pompa pneumatica per tourniquet emostatico 354
Porta aghi BROWN 302
Porta aghi MASSON 305
Porta aghi MATHIEU 309
Porta-aggi ADSON 303
Porta-aggi ARRUGA 295
Porta-aggi BARRAQUER 296-297
Porta-aggi BARRAQUER-TROUTMAN 296
Porta-aggi BAUMGARTNER 302
Porta-aggi CASTROVIEJO micro 298-300
Porta-aggi CASTROVIEJO(JACOBSON) micro 299
Porta-aggi COLLIER 301
Porta-aggi con inserti in TC BARRAQUER curvo 314,315
Porta-aggi con inserti in TC BAUMGARTNER 318
Porta-aggi con inserti in TC BOZEMANN 322
Porta-aggi con inserti in TC CASTROVIEJO (JACOBSON) 313,314
Porta-aggi con inserti in TC CONVERSE 317
Porta-aggi con inserti in TC CRILE 327
Porta-aggi con inserti in TC CRILE-WOOD 320
Porta-aggi con inserti in TC CRILE-WOOD baby 319
Porta-aggi con inserti in TC DEBAKEY 320
Porta-aggi con inserti in TC DERF 316
Porta-aggi con inserti in TC DIETHRICH 316
Porta-aggi con inserti in TC FINOCHIETTO 323
Porta-aggi con inserti in TC GILLIES 324
Porta-aggi con inserti in TC GILLIES baby 324
Porta-aggi con inserti in TC HALSEY 317
Porta-aggi con inserti in TC HEGAR modello spesso 319
Porta-aggi con inserti in TC HEGAR per vasi 321
Porta-aggi con inserti in TC HEPP-SCHIEDEL 316
Porta-aggi con inserti in TC HÖSEL 327
Porta-aggi con inserti in TC HÖSEL 328
Porta-aggi con inserti in TC KILNER 318
Porta-aggi con inserti in TC LANGENBECK 326
Porta-aggi con inserti in TC LICHTENBERG 327
Porta-aggi con inserti in TC MASSON 323
Porta-aggi con inserti in TC MATHIEU 325,326
Porta-aggi con inserti in TC MATHIEU-KOCHER 325
Porta-aggi con inserti in TC MATHIEU-RYDER 326
Porta-aggi con inserti in TC MAY-HEGAR modello sottile 319
Porta-aggi con inserti in TC MAYO-HEGAR 318
Porta-aggi con inserti in TC MAYO-HEGAR (HEANEY) 319
Porta-aggi con inserti in TC MAYO-HEGAR modello pesante 319
Porta-aggi con inserti in TC NEIVERT 317
Porta-aggi con inserti in TC RYDER mini 321
Porta-aggi con inserti in TC SAROT 322
Porta-aggi con inserti in TC SENNING 322
Porta-aggi con inserti in TC STRATTE 323
Porta-aggi con inserti in TC TOENNIS 327
Porta-aggi con inserti in TC WANGENSTEEN 323
Porta-aggi con inserti in TC WEBSTER 317
Porta-aggi con inserti in TC YASARGIL 315
Porta-aggi con inserti in TC ZWEIFEL 328
Porta-aggi CRILE MURRAY 303
Porta-aggi CRILE WOOD 303
Porta-aggi DERF 301
Porta-aggi FINOCHIETTO 306
Porta-aggi French eye con inserti in TC RYDER 320
Porta-aggi GILLIES 308
Porta-aggi GILLIES baby 308
Porta-aggi GOMEL 297
Porta-aggi HALSEY 302
Porta-aggi HALSEY 302
Porta-aggi HEANEY 305
Porta-aggi HEGAR 307
Porta-aggi JAMISON 305
Porta-aggi JOHNSON 306
Porta-aggi KALT 295
Porta-aggi LICHTENBERG 309
Porta-aggi MASS-GENERAL-HOSPITAL 303
Porta-aggi MATHIEU-KOCHER 309
Porta-aggi MATHIEU-RYDER 309

Porta-aggi MAYO-HEGAR 307
Porta-aggi METZENBAUM 303
Porta-aggi micro 296-300
Porta-aggi NEIVERT 302
Porta-aggi OLSEN-HEGAR 308
Porta-aggi STRATTE 307
Porta-aggi TOENNIS 309
Porta-aggi WANGENSTEEN 306
Porta-aggi WEBSTER 301
Porta-aggi YASARGIL 358
Porta-aggi MAYO-HEGAR 304
Porta-aggi asciugamani ADAMS 808
Porta-aggi progenie OBWEGESER 821
Portacotone FARRELL 229
Portacotone FEIN 229
Portacotone JOBSON-HORNE 229
Portacotone PELTESON 229
Portalamette TROUTMANN-CHRIS 14
Porta lampada di ricambio 285
Portamorsetti DE MARTEL-WOLFSON 614
Portaspatola LEYLA 549
Portaspatola LEYLA 550
Portastrumenti 871
Portastrumenti 873
Proctoscopia KELLY 626
Prolunga BRUENINGS 836
Punta COUPLAND 239
Punta per biopsia KEVORKIAN 684
Punta per biopsia SCHUMACHER 685
Punta per biopsia TISCHLER-MORGAN 684
Punta per biopsia TOWNSEND 684
Punta per pinza per biopsia TOWNSEND mini (TISCHLER baby) 684
Punta per pinza per biopsia TOWNSEND mini (TISCHLER baby) 684
Puntale per sonda in plastica NABATOFF 227
Punteruolo 356
Punteruolo con manico a T 356
Punteruolo per mandibola KELSEY-FRY 827
Punteruolo per mandibola OBWEGESER 826
Punteruolo PERTHES 356
Punzonatrice per laminectomia FERRIS-SMITH-KERRISON 591
Punzonatrice per laminectomia KERRISON, non smontabile 577-598
Punzonatrice per laminectomia LOVE-KERRISON 582
Punzone corneosclerale HOLT 715
Punzone KEYES 851
Punzone per antro CITELLI 750, 837
Punzone per antro STAMMBERGER 772
Punzone per orecchio BEYER 750
Punzonatrice per antro CITELLI 777
Punzonatrice per antro KERRISON 777
Punzonatrice per ossa sfenoidi HAJEK 776
Punzonatrice per ossa sfenoidi HAJEK-KOFLER 776

R

Raschietto per lupus VIDAL 850
Recuperatore di suture 336
Recuperatore di suture per tourniquet RUMEL-BELMONT 541
Retratore ALLPORT 197
Retratore per amputazione PERCY 355
Retratore per amputazione PERCY 355
Rettoscopio FANSLER 626
Rettoscopio HIRSCHMANN 625
Rettoscopio IVES-FANSLER 625
Riflettore con lampada frontale ZIEGLER 260
Ring stripper VOLLMAR 228
Rompilamette 14
Rompilamette e portalamette CASTROVIEJO 14
Rubinetto a tre vie LUER-LOCK 244

S

Sacchetto di protezione in plastica per set per trachea 847
SALENIUS 437
Salpingografo SCHULTZE 694
SATINSKY 487, 488
Scalpelli monouso 9,10
Scalpello anatomico 2
Scalpello HIBBS 385
Scalpello HOKE 384
Scalpello LAMBOTTE mini 382
Scalpello LEXER mini 388
Scalpello PARTSCH 380,381
Scalpello per setto FREER 784
Scalpello per sterno LEBSCH 474
Scalpello piatto 380,381,384-385,387-392
Scalpello piatto ALEXANDER 381
Scalpello piatto con manico in Ferrocil 390,391
Scalpello piatto WEST 715
Scalpello STILLE 381
Scatola di riserva DEPONETTE 864
Scatola per cotone idrofilo con coperchio con pomello 874
Scatole di riserva 865
Schiacciarticlagine COTTLE con pinzetta da presa 791
Sega GIGLI 544
Sega LANGENBECK 353
Sega OLIVECRONA 544
Sega oscillante per apparecchi gessati 350
Sega per amputazione BIER 352
Sega per amputazione CHARRIERE 353
Sega per amputazione RUST 352
Sega per amputazione SATTERLEE 353
Sega per anelli MARTIN 469
Sega per anelli WALTON 469
Sega per apparecchi gessati BERGMANN 348
Sega per apparecchi gessati ENGEL 348
Sega per naso JOSEPH 791
Separatori per dura madre FRAZIER 556
Separatori per dura madre HORSLEY 556
Separatori per dura madre MILLIGAN 556
Separatori per dura madre SACHS 556
Serranodi per tonsille BRUENINGS 835
Serranodi per tonsille EVES 835
Serranodi per tonsille TYDING 836
Serranodo auricolare KRAUSE 746
Serranodo auricolare KRAUSE-VOSS 746
Serranodo per polipo nasale KRAUSE 765
Serranodo per polipo nasale KRAUSE-VOSS 765
Serrapinza DE MARTEL-WOLFSON 614
Set clip MINI-Assistent 340
Set di dilatatori per dotto biliare BAKES 632
Set di trefine KEYES completo su piastra 851
SET FERRI 258
Set LEYLA completo 549
Set per trachea 847,848
Set per tunneling 538
Set per tunneling MARTIN 538
Sfigmomanometro 264
Sfigmomanometro a parete 265
Sgorbia 380,381,383-385,387-394
Sgorbia ALEXANDER 381
Sgorbia COBB 392
Sgorbia DAHMEN 393,394
Sgorbia HIBBS 385
Sgorbia LEXER 389,390
Sgorbia LEXER mini 388
Sgorbia per corpo estraneo MEYER 708
Sgorbia per corpo estraneo WALTON 708
Sgorbia per setto BALLENGER 785
Sgorbia per setto KILLIAN 785
Sgorbia per setto KILLIAN 785
Sgorbia SMITH-PETERSON 383
Sgorbia STILLE 381
Sgorbia WEST 715
Sgorbia ZIELKE 390

Siringa per ferite e vescica JANET	246	Speculum auricolare BOUCHERON	741	Strumento doppio, avvitabile	717
Siringa per ferite e vescica LUER-LOCK	246	Speculum auricolare FARRIOR	740	Strumento guida DE MARTEL	544
Siringa per insulina LUER	245	Speculum auricolare HARTMANN	740	Supporto a soffitto REICHERT	840
Siringa per orecchio	760	Speculum auricolare ZÖLLNER anodizzato nero	741	Supporto KALLMORGEN	658
Siringa per orecchio REINER	759	Speculum auricolare, monouso	259	Supporto KRISTELLER	653-657
Siringa per tubercolina LUER	246	Speculum auricolare, riutilizzabile	259	Supporto mano MARTIN-VICKERS	467
Soffiatore di polvere UNIVERSALE	757	Speculum AUVARD	661	Supporto MATHIEU	659
Soffiatore per polvere KABIERSKE completo	757	Speculum BREISKY	662	Supporto per 12 speculi auricolari	741
Sonda a doppio attacco JACOBSON	562	Speculum CASPAR	575	Supporto per seno	284
Sonda a foglia di mirto	224	Speculum DOYEN	659	Supporto per seno con base per laringoscopia	284
Sonda BRODIE	225	Speculum EASTMAN	651	Supporto per seno NEGUS	810
Sonda cava	224,225	Speculum GRAVE	650		
Sonda cava con dispositivo a pulsante	225	Speculum KALLMORGEN	658		
Sonda cava DOYEN	225	Speculum nasale BECKMANN	765		
Sonda cava LOCKHARD-MUMMERY	225,226	Speculum nasale COTTLE	764		
Sonda cava NELATON	225	Speculum nasale GOLDSMITH (THUDICHUM)	762		
Sonda con dispositivo a pulsante	224	Speculum nasale HARTMANN	763		
Sonda di dilatazione RITTER-HALLE	805	Speculum nasale HARTMANN-HALLE	762		
Sonda e cucchiaio per calcoli biliare MOYNIHAN	633	Speculum nasale KILLIAN	764		
Sonda guida cava	334	Speculum nasale KILLIAN	764		
Sonda guida cava BRUNNER	334	Speculum nasale TIECK-HALL	763		
Sonda guida cava FORGE-PAYR	335	Speculum nasale WIEN	763		
Sonda guida cava in Ferrocil	336	Speculum PEDERSON	650		
Sonda guida cava in Ferrocil BRUNNER	336	Speculum per ipofisectomia LANDOLT-CUSHING	561		
Sonda guida cava in Ferrocil KIRSCHNER	336	Speculum rettale BARR	623		
Sonda guida cava KIRSCHNER	334	Speculum rettale BODENHAMMER	622		
Sonda guida cava KÖNIG	334,335	Speculum rettale CZERNY	622		
Sonda guida cava PAYR	335	Speculum rettale MATHIEU	624		
Sonda guida cava SCHMIEDEN	335	Speculum rettale PRATT	623		
Sonda guida cava, Ferrocil	337	Speculum rettale SIMS	622		
Sonda MAYO	633	Speculum SCHERBACK	660		
Sonda oftalmica BOWMAN	716	Speculum SIMS	652		
Sonda passatendini BUNNELL	439	Speculum vaginale COLLIN	649		
Sonda per calcoli biliari DESJARDIN	633	Speculum vaginale CUSCO	648		
Sonda per gozzo KOCHER	849	Speculum vaginale DOYEN	662		
Sonda per utero COLLIN	668	Speculum vaginale JACKSON	651		
Sonda per utero MARTIN	668	Speculum vaginale KRISTELLER	653-657		
Sonda per utero SIMS	668	Speculum vaginale LANDAU	662		
Sonda per utero VALLEIX	668	Speculum vaginale laterale	678		
Sonda scorrevole FILIFORM	641	Speculum vaginale SEMM	650		
Sonda STACK	224	Speculum vaginale SEYFFERT	650		
Sonda trabecolare HARMS	716	Speculum vaginale SIMS	652		
Sonda UCKERMANN	229	Speculum vaginale standard CUSCO	649		
Sonde	224	Speculum vaginale TRELAT	651		
Spatola	553	Speculum vaginale WHITEBARTH	661		
Spatola addominale	195	Spezzacrano SMELLIE	700		
Spatola addominale HABERERERER	195	Spray per strumenti	880		
Spatola addominale REVERDIN	195	Spremicomedoni KATSCH	852		
Spatola addominale RIBBON	195	Spremicomedoni SAALFELD	852		
Spatola autobloccante LEYLA	549,551	Spremicomedoni SCHAMBERG	852		
Spatola CASTROVIEJO	712	Spremicomedoni UNNA	852		
Spatola CASTROVIEJO-BARRAQUER	711	Spremicomedoni UNNA-VIDAL	852		
Spatola DAVIS flessibile	553	Stazione di ricarica per manico a luce fredda	280		
Spatola ELSCHNIG	712	Stetoscopia anestetofono	251		
Spatola HEIFETZ	553	Stetoscopia duplex	251		
Spatola KADER	190	Stetoscopia duplex baby	251		
Spatola KUEMMEL	190	Stetoscopia PINARD, alluminio	250		
Spatola OLIVECRONA	553	Stetoscopia PINARD, legno	250		
Spatola per intima	539	Strumentario per circoncisione	644		
Spatola per laringoscopia MC INTOSH	270,275,276	Strumentario per circoncisione MOGEN	644		
Spatola per laringoscopia telescopica	273	Strumentario per dita FELDHEIM	468		
Spatola per polmone ALLISON	486	Strumentario per l'apertura della scatola cranica ONE	546		
Spazzola di pulizia	847,881-885	Strumentario per l'apertura della scatola cranica DAHLGREN	546		
Spazzole per pulizia	881-885	Strumentario per l'apertura della scatola cranica DE VILBISS	546		
Spazzolino per lavaggio mani asettico	858	Strumentario per mioma DOYEN	676		
Specchio per laringe	842	Strumentario per sutura YOUNG	330		
Specchio per laringe MICHEL	842	Strumentario per uretrografia KNUTSON	644		
Speculi auricolari TOYNBEE	740	Strumenti per l'apertura della scatola cranica	544		
Speculi EASTMAN, grandi	651	Strumento a due dischi CASTROVIEJO	717		
Speculi MATHIEU	659	Strumento a due dischi DIX	717		
Speculi per endoscopia GOODALL	678	Strumento da presa per tendine	440,441		
Speculi per endoscopia KOGAN	677	Strumento da presa per tendine CAROLL	441		
Speculi rettali SCHULZE-BERGMANN	624	Strumento di sensibilità WARTENBERG	250		
Speculi vaginali	648-662				
Speculum auricolare	259				

T

Tappetino in silicone	866
Tappo per tamponi LUNIATSCHEK	833
Telaio CASPAR	569-574
Telaio DENIS-BROWNE	220
Telaio di montaggio ROCHARD	222
Telaio FRANZ	221
Telaio KIRSCHNER	218
Telaio MILLIN da solo	639
Telaio per divarcatore per bocca MC IVOR	812
Telaio SCOVILLE	566
Telaio SCOVILLE-HAVERFIELD	566
Telaio SEMM	220
Tenaglie	547
Tenaglie argento MC KENZIE	547
Tenaglie di bloccaggio MC KENZIE	547
Tenaglie per cuoio capelluto RANEY	548
Tenaglie per ossa	442-451
Tenaglie per ossa DINGMANN	442
Tenaglie per ossa FARABEUF	446
Tenaglie per ossa FARABEUF-LAMBOTTE	446
Tenaglie per ossa FERGUSSON	444
Tenaglie per ossa FROSCA	444
Tenaglie per ossa GERSTER	361
Tenaglie per ossa KERN	445,446
Tenaglie per ossa KERN baby	445
Tenaglie per ossa LAMBOTTE	447
Tenaglie per ossa LANE	448
Tenaglie per ossa LANGENBECK	444,445
Tenaglie per ossa LEWIN	443
Tenaglie per ossa LOWMAN	360
Tenaglie per ossa LOWMAN-HOGLUND	361
Tenaglie per ossa LOWMAN-LAMBERT	361
Tenaglie per ossa MARTIN	442
Tenaglie per ossa SEMB	446
Tenaglie per ossa TUFFIER	447
Tenaglie per ossa ULRICH	449,450
Tenaglie per ossa VERBRUGGE	452
Tenaglie per ossa, autocentranti	451
Tenaglie, uncino per galea	547
Tendifilo LOUTE	369
Terminale a luce fredda MILLIN per fibre ottiche	639
Terminale AQUAJET per pistola per pulizia	879
Terminale per broncoscopia BRUENINGS	839
Terminale per broncoscopia CORDES	839
Terminale per broncoscopia FRAENKEL	839
Terminale per broncoscopia KRAUSE	839
Terminale per broncoscopia LANGE	839
Terminale per broncoscopia ROSENBERG	839
Terminale per broncoscopia SCHEINMANN	839
Terminale per broncoscopia SCHUMACHER	839
Terminale per broncoscopia SIFT	839
Terminale per valvola, da solo	760
Terminale SLUDDER-BALLENGER	836
Testa di accoppiamento LEYLA	551,552
Testa per otoscopia	259
Tonometro SCHIOETZ	704
Tonsillotomo SLUDDER-BALLENGER	836
Torcifilo BOZEMANN	336
Tourniquet emostatico per amputazione	354
Tourniquet RUMEL-BELMONT flessibile	541

Inhaltsverzeichnis
Alphabetical Index
Indice alfabético
Indice alfabético

Tourniquet, trapano per unghie 468
 Trapano CUSHING 358
 Trapano D'ERRICO 358
 Trapano per dita delle mani e dei piedi MARTIN-IDEAL. 468
 Trefine corneale ELLIOT, completi in
 contenitore metallico 714
 Trefine ELLIOT 714
 Trefine STILLE 357
 Trocar BULEAU 231
 Trocar DOUGLAS 231
 Trocar KRAUSE 231
 Trocar LANDAU 232
 Trocar LICHTWITZ 231
 Trocar NELSON 230
 Trocar OCHSNER 231
 Trocar per antro PIERCE 231
 Trocar per mandibola COAKLEY 232
 Trocar per trachea UECKERMANN 843
 Trocar standard 230
 Trocar universale 230
 Tronchese chirurgica 366
 Tronchesi per cuticole 855
 Tronchesi per unghie 854,855
 Tronchesi per unghie TURNBULL 854
 Tubo flessibile di raccordo 760
 Tubo per aspirazione ADSON 232
 Tubo per aspirazione ANDREWS-PYNCHON 238
 Tubo per aspirazione COGSWELL 234
 Tubo per aspirazione COOLEY 239
 Tubo per aspirazione FRAZIER 232
 Tubo per aspirazione LEMPERT 233
 Tubo per aspirazione MAGILL 235
 Tubo per aspirazione PLESTER 233,234
 Tubo per aspirazione POOLE 238
 Tubo per aspirazione POPPEN 233
 Tubo per aspirazione YANKAUER 238
 Tubo per aspirazione YASARGIL 237

U

Uncinetti per nervi CRILE 540
 Uncino a doppio attacco GUTHRIE 709
 Uncino CASPAR con chiusura istantanea 569,570
 Uncino cistico PRATT 626
 Uncino GRAEFFE 154
 Uncino GUTHRIE 154
 Uncino Iris GRAEFE 708
 Uncino KNAPP-ROLLET 709
 Uncino nasale 797
 Uncino nasale AUFRICHT 798
 Uncino nasale AUFRICHT 800
 Uncino nasale con alette CONVERSE 796,798
 Uncino nasale con alette KILNER 798
 Uncino nasale con alette LANGE 796
 Uncino nasale con alette NEIVERT 800
 Uncino nasale COTTLE 796
 Uncino nasale COTTLE 800
 Uncino nasale COTTLE-NEIVERT 799
 Uncino nasale FOMON 797
 Uncino oftalmico KNAPP 709
 Uncino oftalmico ROLLET 709
 Uncino per cute GILLIES 851
 Uncino per cute KAYE 851
 Uncino per cute KILNER 850
 Uncino per dura madre CASPAR 560
 Uncino per dura madre KRAYENBÜHL 560
 Uncino per estensore, grande 372
 Uncino per estensore, piccolo 372
 Uncino per fistola SIMON 676
 Uncino per galea YASARGIL 548
 Uncino per ghiandola lacrimale AXENFELD 710
 Uncino per mucose FREER 799
 Uncino per mucose JOSEPH 799
 Uncino per orecchio DAY 754

Uncino per orecchio HARTMANN 753
 Uncino per orecchio LUCAE 754
 Uncino per orecchio WAGENER 754
 Uncino per parete addominale DOYEN 176
 Uncino per pelvi ST.MARKS 189
 Uncino per prostata YOUNG 637
 Uncino per radice nervosa CUSHING 555
 Uncino per radice nervosa GRONINGEN 555
 Uncino per radice nervosa HOLSHER 554
 Uncino per radice nervosa LOVE 554
 Uncino per radice nervosa SCOVILLE 554
 Uncino per ramo nasale OBWEGESER 820
 Uncino per sella turcica COTTLE 800
 Uncino per strabismo GRAEFFE 710
 Uncino per telaio DENIS-BROWNE 220
 Uncino per telaio DOYEN 221
 Uncino per telaio FRANZ 221
 Uncino per telaio KIRSCHNER-BALLFOUR 219
 Uncino per telaio ROCHARD 222
 Uncino per telaio SEMM 220
 Uncino per timo LUKENS 845
 Uncino per tiroide SCHOENBORN 845
 Uncino per tonsille NAGER 833
 Uncino per trachea BOSE 844
 Uncino per trachea ITERSON 844
 Uncino per trachea JACKSON 844,845
 Uncino per trachea LUER 844
 Uncino per trachea ROSE 844
 Uncino per vescica KOCHER 640
 Uncino per vescica LEGUE 640
 Uncino SCOVILLE 566,567
 Uretrotomo OTIS 643
 USA MOD. Cucchiaino tagliente 406
 USA MOD. Divaricatore per apparecchi gessati 349

V

Valva CASPAR 571
 Valva centrale ALAN-PARKS 625
 Valva centrale BALFOUR 217
 Valva centrale COLLIN 213
 Valva centrale GOSSET 215
 Valva centrale HENLEY 202
 Valva centrale LEGUE 640
 Valva centrale ROBIN-MASS 213
 Valva con filo BALFOUR 217
 Valva FRANZ 221
 Valva laterale ALAN-PARKS 625
 Valva laterale CASPAR 569,570,574
 Valva laterale COLLIN 213
 Valva laterale DEBAKEY 481,482
 Valva laterale MERCEDES 484
 Valva laterale MILLIN 639
 Valva laterale per divaricatore SCOVILLE 566,567
 Valva laterale per divaricatore SCOVILLE 567
 Valva laterale RICARD 213
 Valva SCHERBAK 660
 Valve laterali LEGUE 640
 Valvola a sfera KABIERSKE 757
 Vari bisturi oftalmici 707
 Vassoio a forma di rene 876
 Vassoio basculante 872
 Vassoio multiuso 871
 Vassoio per compresse 874
 Vassoio per placenta 877
 VIGORIMETRO a forma di singola palla di gomma 252
 VOLKMANN Cucchiaino tagliente VOLKMANN d/e 408

W

WEITLANER baby 201
 WEITLANER-WULLSTEIN 200